

Koyo®

JTEKT
Koyo | TOYODA

Ball & Roller Bearings



JTEKT

JTEKT CORPORATION

CAT. NO. B2001E-7

<p>1 Structures and types A 1</p> <p>2 Outline of selection A 14</p> <p>3 Selection of type A 16</p>		<p>4 Selection of arrangement A 20</p> <p>5 Selection of dimensions A 24</p> <p>6 Boundary dimensions and bearing numbers A 52</p>		<p>7 Tolerances A 58</p> <p>8 Limiting speed A 84</p> <p>9 Fits A 86</p>		<p>10 Internal clearance A 99</p> <p>11 Preload A 112</p> <p>12 Lubrication A 117</p>		<p>13 Materials A 130</p> <p>14 Shaft and housing design A 133</p> <p>15 Handling A 141</p>		<p>16 Failures A 152</p>		<p>Technical section</p>							
<p>Open type ... B 8 (67, 68, 69, 160, 60) (62, 63, 64)</p> <p>Shielded/sealed type ... B 20 (Z, RU) (RD, RS)</p> <p>Locating snap ring type ... B 32 (N) (NR)</p>		<p>Extra-small & miniature ... B 40 (flanged type ... B 46)</p> <p>Double-row B 52 [42, 43]</p>		<p>Single-row ... B 62 (79, 70, 72, 73, 74)</p> <p>Matched pair ... B 90 (DB, DF) (DT)</p> <p>Double-row ... B 118 (32, 33, 52, 53) (52...2RS, 53...2RS)</p>		<p>Open type ... B 126 (12, 22) (13, 23)</p> <p>Sealed type ... B 132 (22...2RS) (23...2RS)</p> <p>Extended inner ring type ... B 134 [112, 113]</p> <p>Adapter assemblies ... B 136</p>		<p>NU NJ NUP N NF</p> <p>Single-row ... B 142 (NU10, NU2, NU22, NU32) (NU3, NU23, NU33, NU4)</p> <p>Thrust collars ... B 168 [HJ]</p> <p>NN NNU</p> <p>Double-row ... B 178 (NN30) (NNU49)</p>		<p>Metric series ... B 194 Inch series B 224 (329, 320, 330, 331, 302, 322) (332, 303, 303D, 313, 323, IS0)</p> <p>TDO type B 268 (462, 463, 46T302, 46T322) (46T303, 46T303D, 46T323)</p> <p>TDI type B 284 [452, 453]</p>				<p>R, RR RZ RHA</p> <p>... B 294 (239, 230, 240, 231, 241) (222, 232, 213, 223)</p> <p>Adapter assemblies ... B 318</p> <p>Withdrawal sleeves ... B 326</p>		<p>Single direction ... B 338 (511, 512, 513, 514) (532, 533, 534) (532U, 533U, 534U)</p> <p>Double direction ... B 348 (522, 523, 524) (542, 543, 544) (542U, 543U, 544U)</p> <p>... B 356 [292, 293, 294]</p>		<p>Needle roller and cage ass'y Metric ... B 380 Inch ... B 408</p> <p>Drawn cup type Metric ... B 414 Inch ... B 424</p> <p>Heavy-duty type Metric ... B 432 Inch ... B 440</p> <p>Thrust needle roller Metric ... B 444 Inch ... B 452</p> <p>Thrust cylindrical roller ... B 448</p> <p>Combined ... B 460, B 462 [Ball thrust series] [Cylindrical roller thrust series]</p> <p>Inner ring ... B 466</p> <p>[Miniature one-way clutches] ... B 482</p>	
<p>[Products Introduction]</p> <p>· Ball bearing units B 486</p>		<p>[Products Introduction]</p> <p>· EXSEV & Ceramic bearing series C 57</p> <p>· Bearings for machine tool spindles (for support of axial loading) C 59</p>		<p>· Precision ball screw support bearings and bearing units C 61</p> <p>· Full complement type cylindrical roller bearings for crane sheaves C 63</p>		<p>· Rolling mill roll neck bearings C 65</p>		<p>· Introduction of pamphlets and catalogs D 1</p> <p>· Products introduction of JTEKT (Bearings, Automotive Components, Sensors, Machine tools, Mechatronics) D 13</p> <p>· Products introduction in Japan Group Companies D 19</p>		<p>Introduction of products, pamphlets and catalogs</p>									
<p>· Supplementary tables E 1 – E 28</p>		<p>Supplementary tables</p>		<p>Index</p>		<p>Index</p>		<p>Index</p>		<p>Index</p>									
<p>· Index F 1 – F 18</p>		<p>Index</p>		<p>Index</p>		<p>Index</p>		<p>Index</p>		<p>Index</p>									

Koyo[®]

**BALL & ROLLER
BEARINGS**



Publication of Rolling Bearing Catalog

Today's technology-based society, in order to utilize the earth's limited resources effectively and protect the environment, must strive to develop new technologies and alternate energy sources, and in that connection it continues to pursue new targets in various fields. To achieve such targets, technically advanced and highly functional rolling bearings with significantly greater compactness, lighter weight, longer life and lower friction as well as higher reliability during use in special environments are sought.

This new-edition catalog is based on the results of wide-ranging technical studies and extensive R&D efforts and will enable the reader to select the optimal bearing for each application.

JTEKT is confident that you will find this new catalog useful in the selection and use of rolling bearings. JTEKT is grateful for your patronage and look forward to continuing to serve you in the future.

★The contents of this catalog are subject to change without prior notice. Every possible effort has been made to ensure that the data herein is correct; however, JTEKT cannot assume responsibility for any errors or omissions.

Reproduction of this catalog without written consent is strictly prohibited

Contents

Technical section

1	Rolling bearing structures and types	
	1-1 Structure	A 1
	1-2 Type	A 1
2	Outline of bearing selection	A 14
3	Selection of bearing type	A 16
4	Selection of bearing arrangement	A 20
5	Selection of bearing dimensions	
	5-1 Bearing service life	A 24
	5-2 Calculation of service life	A 24
	5-3 Calculation of loads	A 32
	5-4 Dynamic equivalent load	A 38
	5-5 Basic static load rating and static equivalent load.....	A 42
	5-6 Allowable axial load for cylindrical roller bearings.....	A 44
	5-7 Applied calculation examples...A	46
6	Boundary dimensions and bearing numbers	
	6-1 Boundary dimensions.....	A 52
	6-2 Dimensions of snap ring grooves and locating snap rings	A 53
	6-3 Bearing number.....	A 54
7	Bearing tolerances	
	7-1 Tolerances and tolerance classes for bearings	A 58
	7-2 Tolerance measuring method...A	80
8	Limiting speed	
	8-1 Correction of limiting speed.....	A 84
	8-2 Limiting speed for sealed ball bearings...A	85
	8-3 Considerations for high speed...A	85
	8-4 Frictional coefficient (refer.).....	A 85

9	Bearing fits	
	9-1 Purpose of fit	A 86
	9-2 Tolerance and fit for shaft & housing	A 86
	9-3 Fit selection	A 87
	9-4 Recommended fits	A 90

10	Bearing internal clearance	
	10-1 Selection of internal clearance	A 99
	10-2 Operating clearance	A 100

11	Preload	
	11-1 Purpose of preload	A 112
	11-2 Method of preloading.....	A 112
	11-3 Preload and rigidity.....	A 113
	11-4 Amount of preload	A 114

12	Bearing lubrication	
	12-1 Purpose and method of lubrication	A 117
	12-2 Lubricant.....	A 124

13	Bearing materials	
	13-1 Bearing rings and rolling elements materials.....	A 130
	13-2 Materials used for cages	A 132

14	Shaft and housing design	
	14-1 Accuracy and roughness of shafts and housings	A 133
	14-2 Mounting dimensions	A 134
	14-3 Shaft design	A 136
	14-4 Sealing devices	A 137

15	Handling of bearings	
	15-1 General instructions	A 141
	15-2 Storage of bearings	A 141
	15-3 Bearing mounting	A 141
	15-4 Test run	A 146
	15-5 Bearing dismantling.....	A 148
	15-6 Maintenance and inspection of bearings.....	A 150
	15-7 Methods of analyzing bearing failures.....	A 151

16	Examples of bearing failures	A 152
-----------	---	-------

Specification tables	Contents	B 2
-----------------------------	-----------------------	-----

[Standard bearings]

• Deep groove ball bearings.....	B 4
• Angular contact ball bearings	B 54
• Self-aligning ball bearings.....	B 124
• Cylindrical roller bearings	B 138
• Tapered roller bearings.....	B 184
• Spherical roller bearings	B 290
• Thrust ball bearings	B 336
• Spherical thrust roller bearings	B 354
• Needle roller bearings.....	B 362
• Ball bearing units	B 486

[Special purpose bearings]

• K-series super thin section ball bearings	C 1
• Bearings for railway rolling stock axle journals	C 21
• Linear ball bearings	C 31
• Locknuts, lockwashers & lock plates	C 45
• EXSEV & Ceramic bearing series	C 57
• Bearings for machine tool spindles (for support of axial loading)	C 59
• Precision ball screw support bearings and bearing units	C 61
• Full complement type cylindrical roller bearings for crane sheaves	C 63
• Rolling mill roll neck bearings	C 65

[Introduction of products, pamphlets and catalogs]

• Introduction of pamphlets and catalogs	D 1
• Products introduction of JTEKT	D 13
• Products introduction in Japan Group Companies.....	D 19

Supplementary tables

1 Boundary dimensions of radial bearings	E 1
2 Boundary dimensions of tapered roller bearings	E 5
3 Boundary dimensions of single direction thrust bearings.....	E 7
4 Boundary dimensions of double direction thrust ball bearings.....	E 9
5 Dimension of snap ring grooves and locating snap rings	E 11
6 Shaft tolerances	E 15
7 Housing bore tolerances	E 17
8 Numerical values for standard tolerance grades IT	E 19
9 Greek alphabet list	E 20
10 Prefixes used with SI units	E 20
11 SI units and conversion factors	E 21
12 Inch/millimeter conversion	E 25
13 Steel hardness conversion	E 26
14 Surface roughness comparison.....	E 27
15 Viscosity conversion.....	E 28

Index

Bearing No. index	F 1
Term index	F 16

1. Rolling bearing structures and types

1-1 Structure

Rolling bearings (bearings hereinafter) normally comprise bearing rings, rolling elements and a cage. (see Fig. 1-1)

Rolling elements are arranged between inner and outer rings with a cage, which retains the rolling elements in correct relative position, so they do not touch one another. With this structure, a smooth rolling motion is realized during operation.

Bearings are classified as follows, by the number of rows of rolling elements : single-row, double-row, or multi-row (triple- or four-row) bearings.

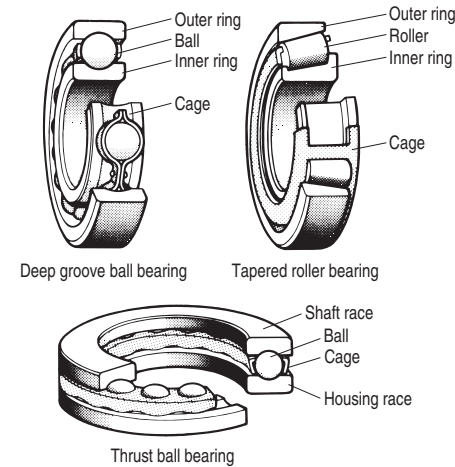

Note) In thrust bearings inner and outer rings are also called "shaft race" and "housing race" respectively. The race indicates the washer specified in JIS.

Fig. 1-1 Bearing structure

1) Bearing rings

The path of the rolling elements is called the raceway; and, the section of the bearing rings where the elements roll is called the raceway surface. In the case of ball bearings, since grooves are provided for the balls, they are also referred to as raceway grooves.

The inner ring is normally engaged with a shaft; and, the outer ring with a housing.

2) Rolling element

Rolling elements may be either balls or rollers. Many types of bearings with various shapes of rollers are available.

- Ball
- Cylindrical roller ($L_w \leq 3 D_w$)*
- ▬ Long cylindrical roller ($3D_w \leq L_w \leq 10D_w, D_w > 6 \text{ mm}$)*
- ▬ Needle roller ($3D_w \leq L_w \leq 10D_w, D_w \leq 6 \text{ mm}$)*
- ▭ Tapered roller (tapered trapezoid)
- ▭ Convex roller (barrel shape)

* $\left(\begin{array}{l} L_w : \text{roller length (mm)} \\ D_w : \text{roller diameter (mm)} \end{array} \right)$

3) Cage

The cage guides the rolling elements along the bearing rings, retaining the rolling elements in correct relative position. There are various types of cages including pressed, machined, molded, and pin type cages.

Due to lower friction resistance than that found in full complement roller and ball bearings, bearings with a cage are more suitable for use under high speed rotation.

1-2 Type

The contact angle (α) is the angle formed by the direction of the load applied to the bearing rings and rolling elements, and a plan perpendicular to the shaft center, when the bearing is loaded.

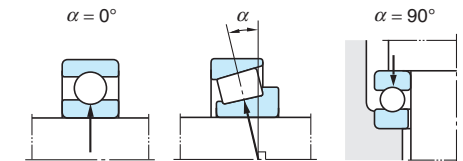

Bearings are classified into two types in accordance with the contact angle (α).

- Radial bearings ($0^\circ \leq \alpha \leq 45^\circ$)
... designed to accommodate mainly radial load.
- Thrust bearings ($45^\circ < \alpha \leq 90^\circ$)
... designed to accommodate mainly axial load.

Rolling bearings are classified in Fig. 1-2, and characteristics of each bearing type are described in Tables 1-1 to 1-13.

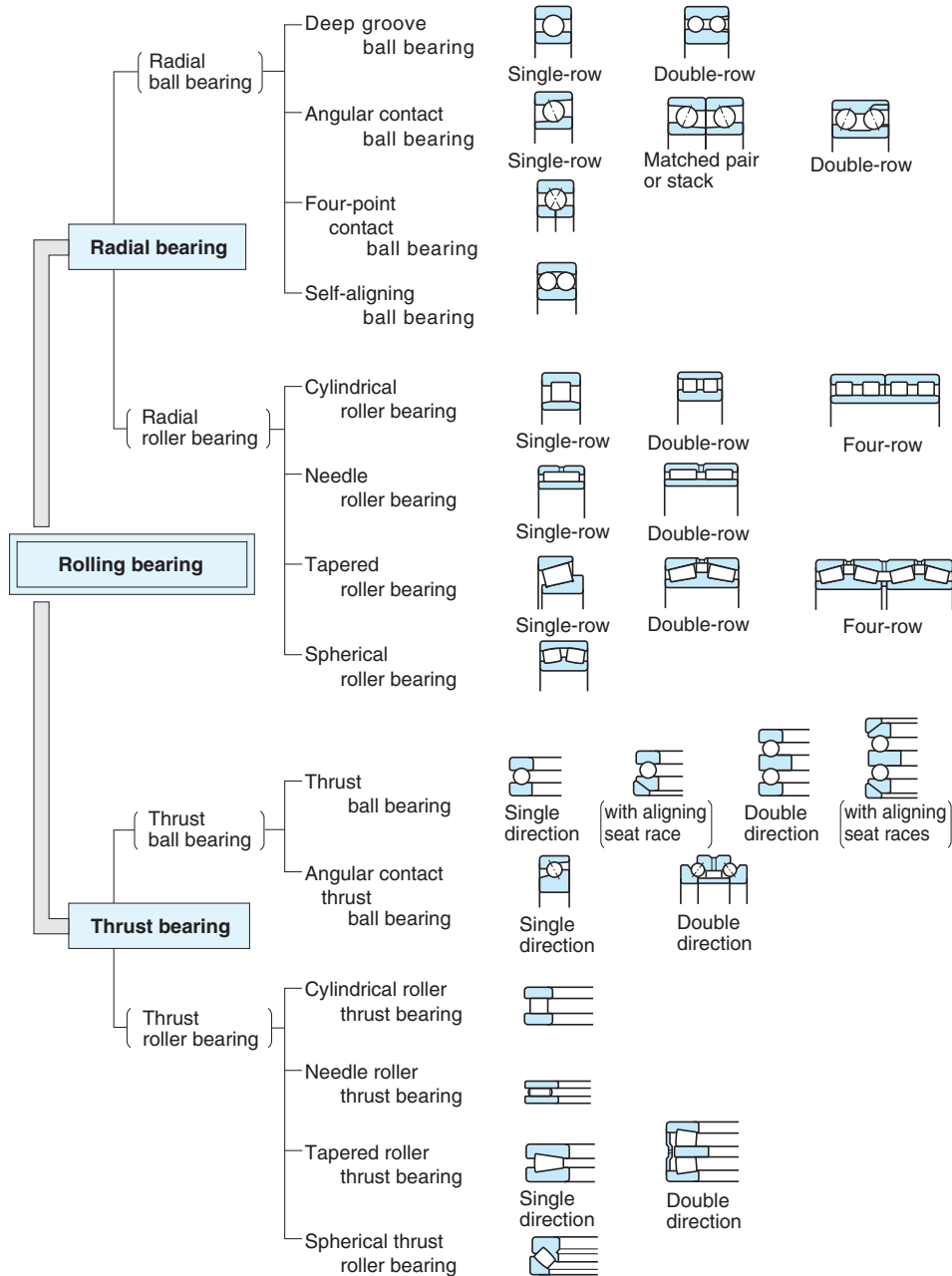

Fig. 1-2(1) Rolling bearings

Bearings classified by use

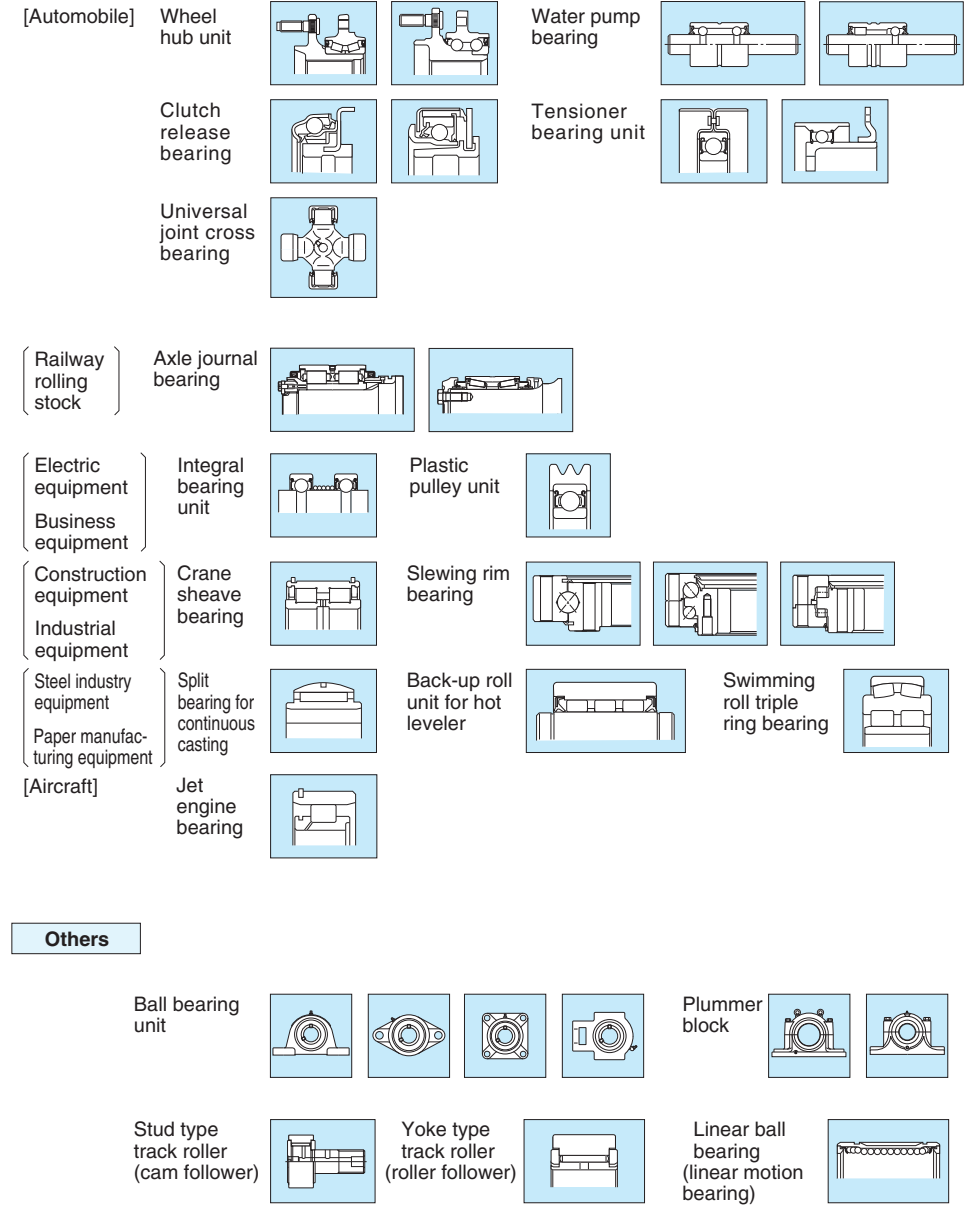

Fig. 1-2(2) Rolling bearings

Table 1-1 Deep groove ball bearings

Single-row							Double-row	
Open type	Shielded type	Non-contact sealed type	Contact sealed type		Extremely light contact sealed type	With locating snap ring	Flanged type	
	ZZ	2RU	2RS	2RK	2RD	NR	(Suitable for extra-small or miniature bearing)	
680, 690, 6700, 6800, 6900, 16000	690, 6000	600, 6200, 6300, 6400	620, 630, (ML) ...Extra-small, miniature bearing				4200, 4300	

- The most popular types among rolling bearings, widely used in a variety of industries.
- Radial load and axial load in both directions can be accommodated.
- Suitable for operation at high speed, with low noise and low vibration.
- Sealed bearings employing steel shields or rubber seals are filled with the appropriate volume of grease when manufactured.
- Bearings with a flange or locating snap ring attached on the outer ring are easily mounted in housings for simple positioning of housing location.

[Recommended cages] Pressed cage (ribbon type, snap type ... single-row, S type ... double-row), copper alloy or phenolic resin machined cage, synthetic resin molded cage

[Main applications] Automobile : front and rear wheels, transmissions, electric devices
 Electric equipment : standard motors, electric appliances for domestic use
 Others : measuring instruments, internal combustion engines, construction equipment, railway rolling stock, cargo transport equipment, agricultural equipment, equipment for other industrial uses

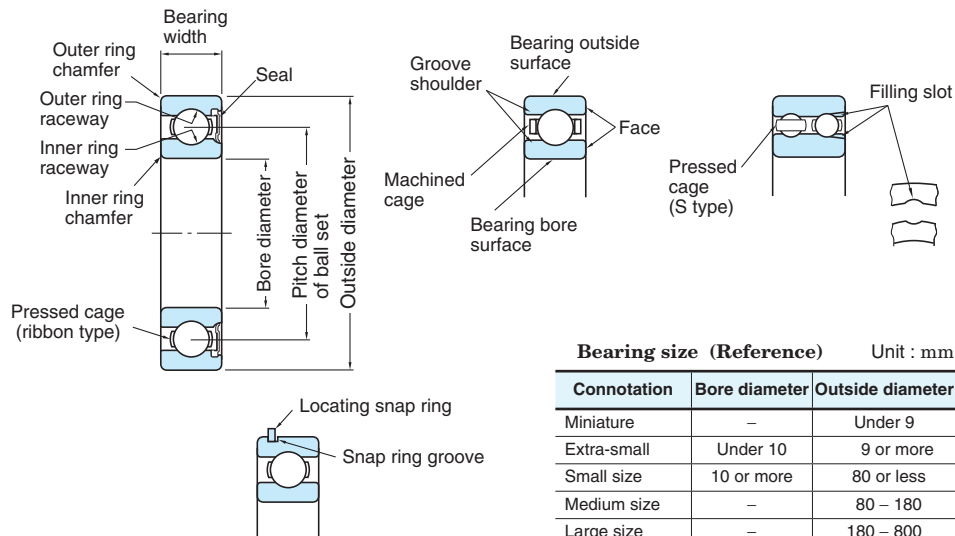

Bearing size (Reference) Unit : mm

Connotation	Bore diameter	Outside diameter
Miniature	-	Under 9
Extra-small	Under 10	9 or more
Small size	10 or more	80 or less
Medium size	-	80 - 180
Large size	-	180 - 800
Extra-large size	-	Over 800

Table 1-2 Angular contact ball bearings

Single-row	Matched pair			Double-row		
	For high-speed use	Back-to-back arrangement	Face-to-face arrangement	Tandem arrangement		
(With pressed cage)	(With machined cage)	HAR	DB	DF	DT	
7000, 7200, 7300, 7400	7000B, 7200B, 7300B, 7400B	Contact angle 30°			3200	5200
7900C, 7000C, 7200C, 7300C	HAR900C, HAR000C	Contact angle 40°			3300	5300
		Contact angle 15°			Contact angle 32°	Contact angle 24°

- Bearing rings and balls possess their own contact angle which is normally 15°, 30° or 40°.
 - (Larger contact angle ... higher resistance against axial load)
 - (Smaller contact angle ... more advantageous for high-speed rotation)
- Single-row bearings can accommodate radial load and axial load in one direction.
- DB and DF matched pair bearings and double-row bearings can accommodate radial load and axial load in both directions. DT matched pair bearings are used for applications where axial load in one direction is too large for one bearing to accept.
- HAR type high speed bearings were designed to contain more balls than standard bearings by minimizing the ball diameter, to offer improved performance in machine tools.
- Angular contact ball bearings are used for high accuracy and high-speed operation.

- Axial load in both directions and radial load can be accommodated by adapting a structure pairing two single-row angular contact ball bearings back to back.
- For bearings with no filling slot, the sealed type is available.

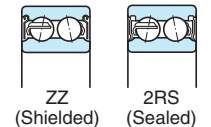

[Recommended cages] Pressed cage (conical type ... single-row : S type, snap type ... double-row), copper alloy or phenolic resin machined cage, synthetic resin molded cage

[Main applications] Single-row : machine tool spindles, high frequency motors, gas turbines, centrifugal separators, front wheels of small size automobiles, differential pinion shafts
 Double-row : hydraulic pumps, roots blowers, air-compressors, transmissions, fuel injection pumps, printing equipment

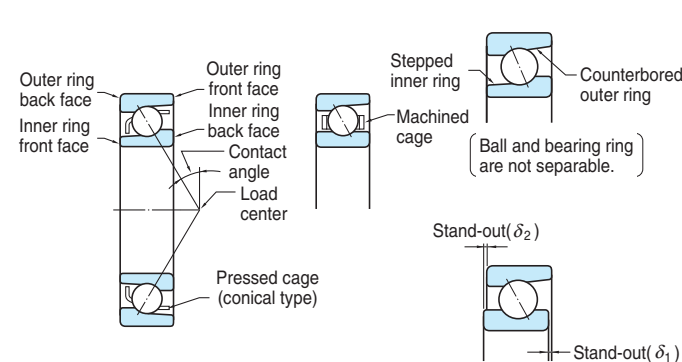

Contact angles (Reference)

Contact angle	Supplementary code
15°	C
20°	CA
25°	AC
30°	A (Omitted)
35°	E
40°	B

"G type" bearings are processed (with flush ground) such that the stand-out turns out to be $\delta_1 = \delta_2$. The matched pair DB, DF, and DT, or stack are available.

Table 1-3 Four-point contact ball bearings

One-piece type	Two-piece inner ring	Two-piece outer ring
—	6200BI 6300BI	(6200BO) (6300BO)

- Radial load and axial load in both directions can be accommodated.
- A four-point contact ball bearing can substitute for a face-to-face or back-to-back arrangement of angular contact ball bearings.
- Suitable for use under pure axial load or combined radial and axial load with heavy axial load.
- This type of bearing possesses a contact angle (α) determined in accordance with the axial load direction. This means that the bearing ring and balls contact each other at two points on the lines forming the contact angle.

[Recommended cage] Copper alloy machined cage

[Main applications]

Motorcycle : Transmission, driveshaft pinion-side
Automobile : Steering, transmission

Table 1-4 Self-aligning ball bearings

Cylindrical bore	Tapered bore	Sealed
120, 130	K (Taper 1 : 12)	2RS
1200, 1300 2200, 2300	(11200, 11300... extended inner ring type)	2200 2RS 2300 2RS

- Spherical outer ring raceway allows self-alignment, accommodating shaft or housing deflection and misaligned mounting conditions.
- Tapered bore design can be mounted readily using an adapter.

Pressed cage (staggered type...12, 13,
22...2RS, 23...2RS)
snap type22, 23

Power transmission shaft of wood working and spinning machines, plummer blocks

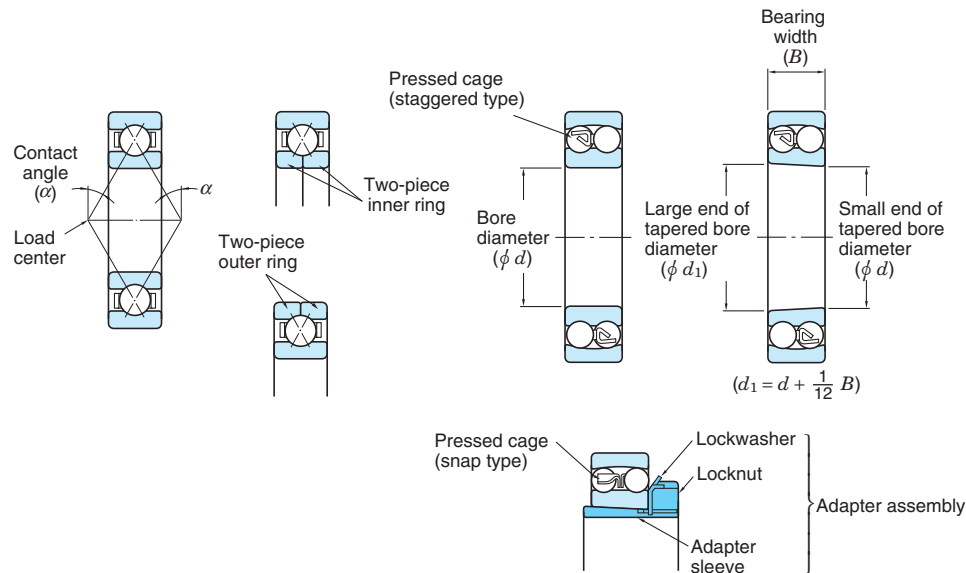

Table 1-5 Cylindrical roller bearings

Single-row						Double-row		Four-row
NU	NJ	NUP	N	NF	NH	NN	NNU	(Mainly use on rolling mill roll neck)
NU1000,	NU200 (R),	NU300 (R),	NU400	NU2200 (R),	NU2300 (R)	Cylindrical bore NNU4900 NN3000	Tapered bore NNU4900K NN3000K	(FC) , (4CR)

- Since the design allowing linear contact of cylindrical rollers with the raceway provides strong resistance to radial load, this type is suitable for use under heavy radial load and impact load, as well as at high speed.
- N and NU types are ideal for use on the free side: they are movable in the shaft direction in response to changes in bearing position relative to the shaft or housing, which are caused by heat expansion of the shaft or improper mounting.

- NJ and NF types can accommodate axial load in one direction; and NH and NUP types can accommodate partial axial load in both directions.
- With separable inner and outer ring, this type ensures easy mounting.
- Due to their high rigidity, NNU and NN types are widely used in machine tool spindles.

[Recommended cages] Pressed cage (Z type), copper alloy machined cage, synthetic resin molded cage

[Main applications] Large and medium size motors, traction motors, generators, internal combustion engines, gas turbines, machine tool spindles, speed reducers, cargo transport equipment, and other industrial equipment

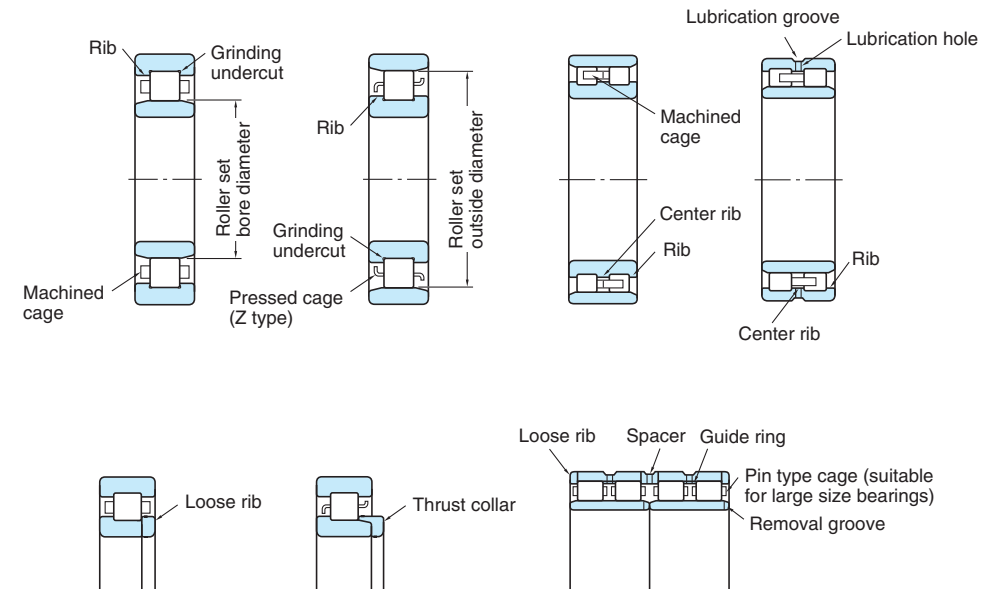

Table 1-6 Machined ring needle roller bearings

Single-row			Double-row	
With inner ring	Without inner ring	Sealed	With inner ring	Without inner ring
NA4800 NA4900 NA6900 (NKJ, NKJS)	RNA4800 RNA4900 RNA6900 (NK, NKS, HJ)	NA49002RS - (HJ.2RS)	NA6900 (d ≥ 32)	RNA6900 (Fw ≥ 40)

- In spite of their basic structure, which is the same as that of NU type cylindrical roller bearings, bearings with minimum ring sections offer space savings and greater resistance to radial load, by using needle rollers.
- Bearings with no inner rings function using heat treated and ground shafts as their raceway surface.

[Recommended cage] Pressed cage

[Main applications] Automobile engines, transmissions, pumps, power shovel wheel drums, hoists, overhead traveling cranes, compressors

(Reference) Many needle roller bearings other than those with machined ring are available. For details, refer to the pages for the needle roller bearing specification tables and the dedicated "Needle Roller Bearings" catalog (CAT No. B2020E), published separately.

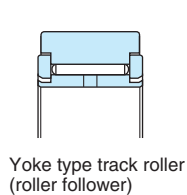
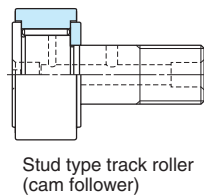
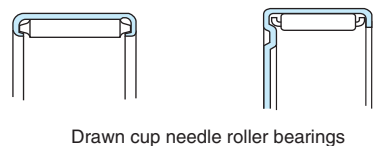
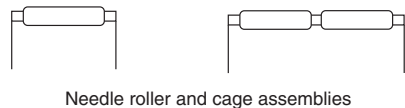
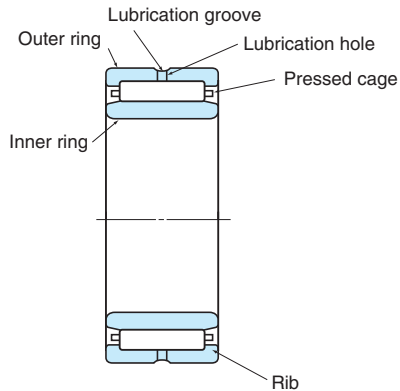

Table 1-7 Tapered roller bearings

Single-row			Double-row		Four-row
Flanged type			TDO type	TDI type	(Mainly used on rolling mill roll necks)
(Standard contact angle)	(Intermediate contact angle)	(Steep contact angle)	46200 46200A 46300 46300A (46T)	45200 45300 (45T)	37200 47200 47300 (47T) (4TR)
32900JR 32000JR 33000JR 33100JR	30200JR 32200JR 33200JR 30300JR	30200CR 32200CR 30300CR 32300CR			

- Tapered rollers assembled in the bearings are guided by the inner ring back face rib.
- The raceway surfaces of inner ring and outer ring and the rolling contact surface of rollers are designed so that the respective apexes converge at a point on the bearing center line.
- Single-row bearings can accommodate radial load and axial load in one direction, and double-row bearings can accommodate radial load and axial load in both directions.
- This type of bearing is suitable for use under heavy load or impact load.
- Bearings are classified into standard, intermediate and steep types, in accordance with their contact angle (α). The larger the contact angle is, the greater the bearing resistance to axial load.
- Since outer ring and inner ring assembly can be separated from each other, mounting is easy.
- Bearings designated by the suffix "J" and "JR" are interchangeable internationally.
- Items sized in inches are still widely used.

[Recommended cages] Pressed cage, synthetic resin molded cage, pin type cage

[Main applications] Automobile : front and rear wheels, transmissions, differential pinion
Others : machine tool spindles, construction equipment, large size agricultural equipment, railway rolling stock speed reduction gears, rolling mill roll necks and speed reducers, etc

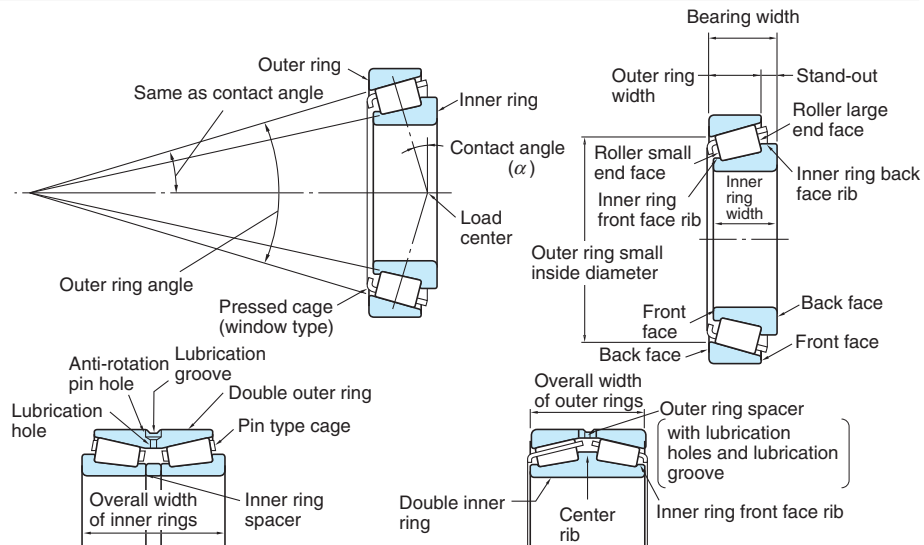

Table 1-8 Spherical roller bearings

Convex asymmetrical roller type	Cylindrical bore		Tapered bore
	Convex symmetrical roller type		
R, RR	RZ	RHA	K or K30
23900R, 23000R (RZ, RHA), 23100R (RZ, RHA), 22200R (RZ, RHA), 21300R (RZ), 24000R (RZ, RHA), 24100R (RZ, RHA), 23200R (RZ, RHA), 22300R (RZ, RHA)			

■ Spherical roller bearings comprising barrel-shaped convex rollers, double-row inner ring and outer ring are classified into three types : R(RR), RZ and RHA, according to their internal structure.

■ With the bearing designed such that the circular arc center of the outer ring raceway matches with the bearing center, the bearing is self-aligning, insensitive to errors of alignment of the shaft relative to the housing, and to shaft bending.

■ This type can accommodate radial load and axial load in both directions, which makes it especially suitable for applications in which heavy load or impact load is applied.

■ The tapered bore type can be easily mounted/dismounted by using an adapter or withdrawal sleeve.

There are two types of tapered bores (tapered ratio) :

- 1 : 30 (supplementary code K30) ... Suitable for series 240 and 241.
- 1 : 12 (supplementary code K) ... Suitable for series other than 240 and 241.

■ Lubrication holes, a lubrication groove and anti-rotation pin hole can be provided on the outer ring. Lubrication holes and a lubrication groove can be provided on the inner ring, too.

[Recommended cages] Copper alloy machined cage, pressed cage

[Main applications] Paper manufacturing equipment, speed reducers, railway rolling stock axle journals, rolling mill pinion stands, table rollers, crushers, shaker screens, printing equipment, wood working equipment, speed reducers for various industrial uses, plummer blocks

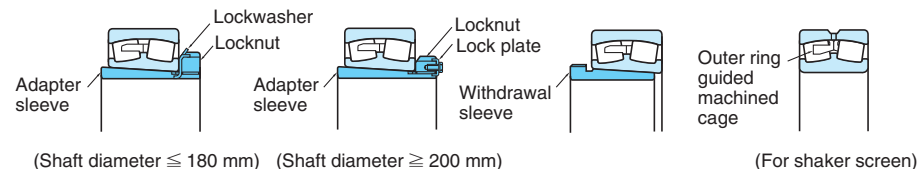
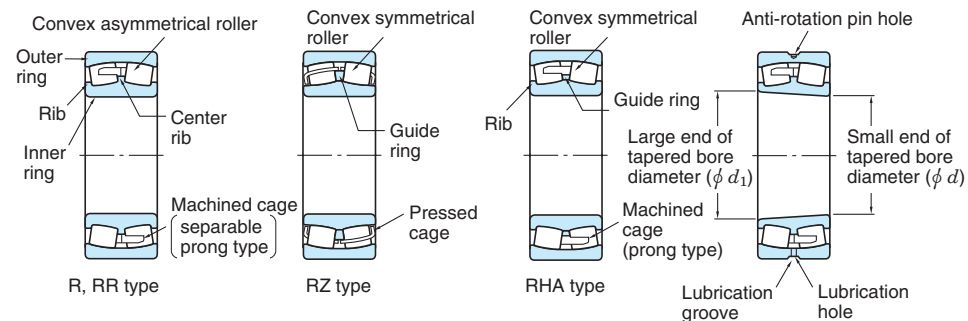

Table 1-9 Thrust ball bearings

Single direction			Double direction		
With flat back faces	With spherical back face	With aligning seat race	With flat back faces	With spherical back faces	With aligning seat races
51100	-	-	-	-	-
51200	53200	53200U	52200	54200	54200U
51300	53300	53300U	52300	54300	54300U
51400	53400	53400U	52400	54400	54400U

■ This type of bearing comprises washer-shaped rings with raceway groove and ball and cage assembly.

■ Races to be mounted on shafts are called shaft races (or inner rings); and, races to be mounted into housings are housing races (or outer rings).

Central races of double direction bearings are mounted on the shafts.

■ Single direction bearings accommodate axial load in one direction, and double direction bearings accommodate axial load in both directions. (Both of these bearings cannot accommodate radial loads.)

■ Since bearings with a spherical back face are self-aligning, it helps to compensate for mounting errors.

[Recommended cages] Pressed cage, copper alloy or phenolic resin machined cage, synthetic resin molded cage

[Main applications] Automobile king pins, machine tool spindles

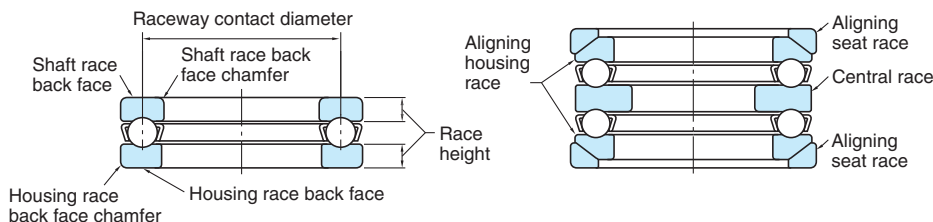
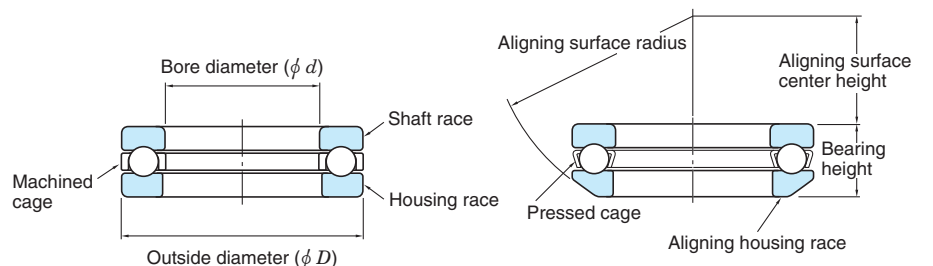

[Remark] The race indicates the washer specified in JIS.

Table 1-10 Cylindrical roller thrust bearings

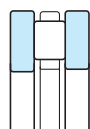
Single direction

(811, 812, NTHA)

- This type of bearing comprises washer-shaped rings (shaft and housing race) and cylindrical roller and cage assembly.
- Crowned cylindrical rollers produce uniform pressure distribution on roller/raceway contact surface.
- Axial load can be accommodated in one direction.
- Great axial load resistance and high axial rigidity are provided.

[Recommended cages] Copper alloy machined cage

[Main applications] Oil excavators, iron and steel equipment

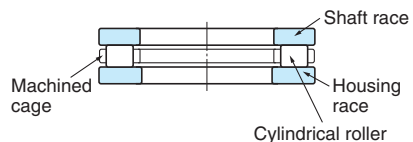
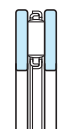
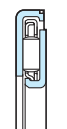

Table 1-11 Needle roller thrust bearings

Separable	Non-separable
	
(AXK, FNT, NTA)	(FNTKF)

- The separable type, comprising needle roller and cage thrust assembly and a race, can be matched with a pressed thin race (AS) or machined thick race (LS, WS.811, GS.811).
- The non-separable type comprises needle roller and cage thrust assembly and a precision pressed race.
- Axial load can be accommodated in one direction.
- Due to the very small installation space required, this type contributes greatly to size reduction of application equipment.
- In many cases, needle roller and cage thrust assembly function by using the mounting surface of the application equipment, including shafts and housings, as its raceway surface.

Pressed cage, synthetic resin molded cage

Transmissions for automobiles, cultivators and machine tools

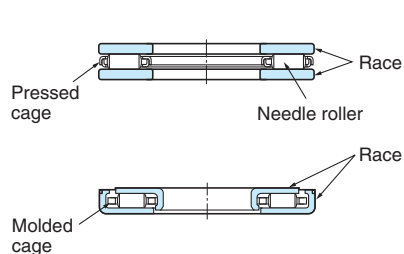

[Remark] The race indicates the thrust washer or washer specified in JIS.

Table 1-12 Tapered roller thrust bearings

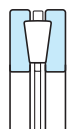
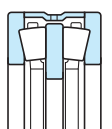
Single direction	Double direction
	
(T) (THR)	(2THR)

- This type of bearing comprises tapered rollers (with spherical large end), which are uniformly guided by ribs of the shaft and housing races.
- Both shaft and housing races and rollers have tapered surfaces whose apexes converge at a point on the bearing axis.
- Single direction bearings can accommodate axial load in one direction; and, double direction bearings can accommodate axial load in both directions.
- Double direction bearings are to be mounted such that their central race is placed on the shaft shoulder. Since this type is treated with a clearance fit, the central race must be fixed with a sleeve, etc.

[Recommended cages] Copper alloy machined cage

[Main applications]

Single direction : crane hooks, oil excavator swivels

Double direction : rolling mill roll necks

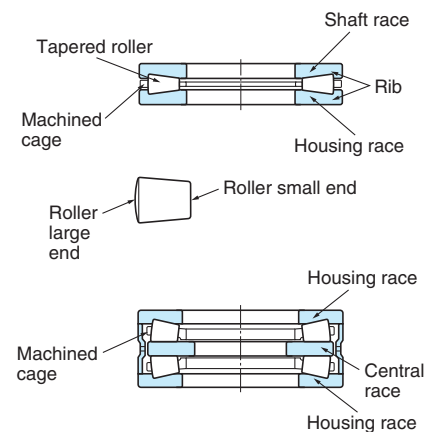
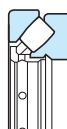

Table 1-13 Spherical thrust roller bearings

29200 29300 29400

- This type of bearing, comprising barrel-shaped convex rollers arranged at an angle with the axis, is self-aligning due to spherical housing race raceway; therefore, shaft inclination can be compensated for to a certain degree.
- Great axial load resistance is provided. This type can accommodate a small amount of radial load as well as heavy axial load.
- Normally, oil lubrication is employed.

Copper alloy machined cage

Hydroelectric generators, vertical motors, propeller shafts for ships, screw down speed reducers, jib cranes, coal mills, pushing machines, molding machines

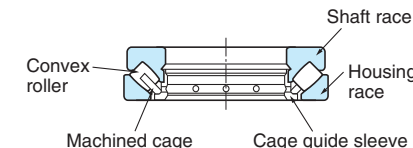

2. Outline of bearing selection

Currently, as bearing design has become diversified, their application range is being increasingly extended. In order to select the most suitable bearings for an application, it is necessary to conduct a comprehensive study on both bearings and the equipment in which the bearings will be installed, including operating conditions, the performance required of the

bearings, specifications of the other components to be installed along with the bearings, marketability, and cost performance, etc.

In selecting bearings, since the shaft diameter is usually determined beforehand, the prospective bearing type is chosen based upon installation space, intended arrangement, and according to the bore diameter required.

Next, from the bearing specifications are determined the service life required when compared to that of the equipment in which it is used, along with a calculation of the actual service life from operational loads.

Internal specifications including bearing accuracy, internal clearance, cage, and lubricant are also selected, depending on the application.

For reference, general selection procedure and operating conditions are described in Fig. 2-1. There is no need to follow a specific order, since the goal is to select the right bearing to achieve optimum performance.

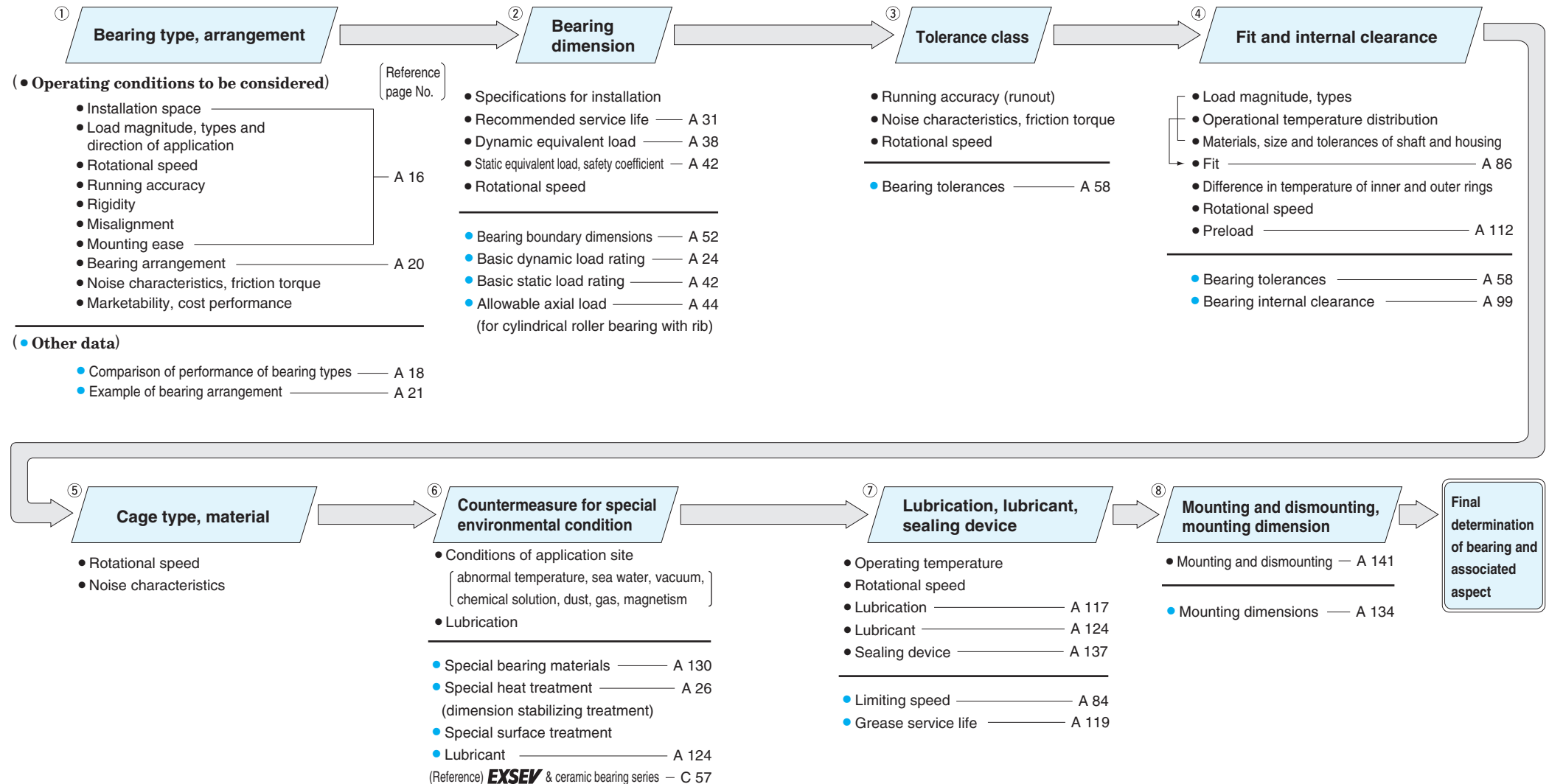

Fig. 2-1(1) Bearing selection procedure

Fig. 2-1(2) Bearing selection procedure

3. Selection of bearing type

In selecting bearings, the most important thing is to fully understand the operating conditions of the bearings.

The main factors to be considered are listed in Table 3-1, while bearing types are listed in Table 3-2.

Table 3-1 (1) Selection of bearing type

Items to be considered	Selection method	Reference page No.
1) Installation space Bearing can be installed in target equipment	<ul style="list-style-type: none"> When a shaft is designed, its rigidity and strength are considered essential; therefore, the shaft diameter, i.e., bore diameter, is determined at start. For rolling bearings, since wide variety with different dimensions are available, the most suitable bearing type should be selected. (Fig. 3-1) 	A 52
2) Load Load magnitude, type and direction which applied (Load resistance of bearing is specified in terms of the basic load rating, and its value is specified in the bearing specification table.)	<ul style="list-style-type: none"> Since various types of load are applied to bearings, load magnitude, types (radial or axial) and direction of application (both directions or single direction in the case of axial load), as well as vibration and impact must be considered in order to select the proper bearing. The following is the general order for radial resistance ; (deep groove ball bearings < angular contact ball bearings < cylindrical roller bearings < tapered roller bearings < spherical roller bearings) 	A 18 (Table 3-2) A 87
3) Rotational speed Response to rotational speed of equipment in which bearings will be installed (The limiting speed for bearing is expressed as allowable speed, and this value is specified in the bearing specification table.)	<ul style="list-style-type: none"> Since the allowable speed differs greatly depending not only upon bearing type but on bearing size, cage, accuracy, load and lubrication, all factors must be considered in selecting bearings. In general, the following bearings are the most widely used for high speed operation. (deep groove ball bearings, angular contact ball bearings, cylindrical roller bearings) 	A 18 (Table 3-2) A 84
4) Running accuracy Accurate rotation delivering required performance (Dimension accuracy and running accuracy of bearings are provided by JIS, etc.)	<ul style="list-style-type: none"> Performance required differs depending on equipment in which bearings are installed : for instance, machine tool spindles require high running accuracy, gas turbines require high speed rotation, and control equipment requires low friction. In such cases, bearings of tolerance class 5 or higher are required. The following are the most widely used bearings. (deep groove ball bearings, angular contact ball bearings, cylindrical roller bearings) 	A 18 (Table 3-2) A 58
5) Rigidity Rigidity that delivers the bearing performance required (When load is applied to a bearing, elastic deformation occurs at the point where its rolling elements contact the raceway surface. The higher the rigidity that bearings possess, the better they control elastic deformation.)	<ul style="list-style-type: none"> In machine tool spindles and automobile final drives, bearing rigidity as well as rigidity of equipment itself must be enhanced. Elastic deformation occurs less in roller bearings than in ball bearings. Rigidity can be enhanced by providing preload. This method is suitable for use with angular contact ball bearings and tapered roller bearings. 	A 18 (Table 3-2) A 112

Table 3-1 (2) Selection of bearing type

Items to be considered	Selection method	Reference page No.
6) Misalignment (aligning capability) Operating conditions which cause misalignment (shaft deflection caused by load, inaccuracy of shaft and housing, mounting errors) can affect bearing performance (Allowable misalignment (in angle) for each bearing type is described in the section before the bearing specification table, to facilitate determination of the self-aligning capability of bearings.)	<ul style="list-style-type: none"> Internal load caused by excessive misalignment damages bearings. Bearings designed to absorb such misalignment should be selected. The higher the self-aligning capability that bearings possess, the larger the angular misalignment that can be absorbed. The following is the general order of bearings when comparing allowable angular misalignment : (cylindrical roller bearings < tapered roller bearings < deep groove ball bearings, angular contact ball bearings < spherical roller bearings, self-aligning ball bearings) 	A 18 (Table 3-2)
7) Mounting and dismounting Methods and frequency of mounting and dismounting required for periodic inspection	<ul style="list-style-type: none"> Cylindrical roller bearings, needle roller bearings and tapered roller bearings, with separable inner and outer rings, are recommended for applications in which mounting and dismounting is conducted frequently. Use of sleeve eases the mounting of self-aligning ball bearings and spherical roller bearings with tapered bore. 	A 18 (Table 3-2)

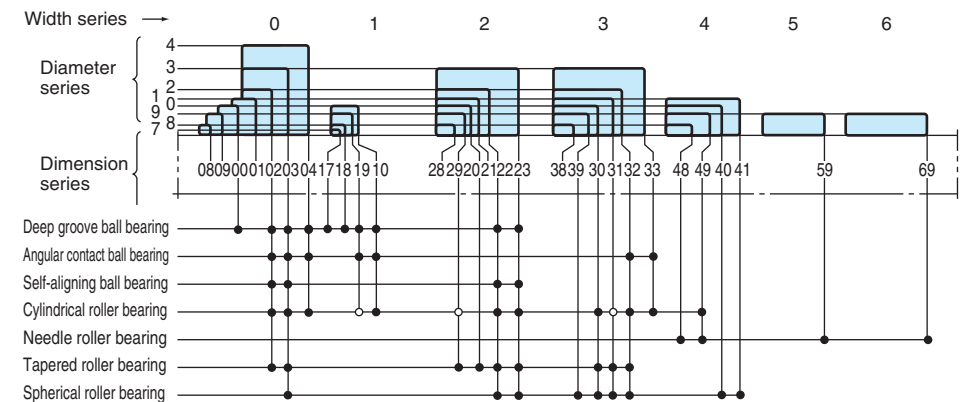

Fig. 3-1 Radial bearing dimension series

Table 3-2 Performance comparison of bearing type

	Deep groove ball bearing	Angular contact ball bearing			Four-point contact ball bearing	Self-aligning ball bearing	Cylindrical roller bearing					Needle roller bearing (machined ring type)	Tapered roller bearing		Spherical roller bearing	Thrust ball bearing		Double direction angular contact thrust ball bearing	Cylindrical roller thrust bearing	Needle roller thrust bearing	Tapered roller thrust bearing	Spherical thrust roller bearing	Reference page No.
		Single-row	Matched pair or stack	Double-row			NU · N	NJ · NF	NUP · NH	NN · NNU			Single-row	Double-row, four-row		With flat back faces	With aligning seat race						
Load resistance	Radial load	○	○	◎	◎	○	○	◎	◎	◎	◎	◎	◎	◎	◎	×	×	×	×	×	×	△	—
	Axial load	○ ↔	◎ ←	◎ ↔*	◎ ↔*	◎ ↔	△ ↔	×	△ ←	△ ↔	×	×	◎ ←	◎ ↔	△ ↔	○ ←*	○ ←*	◎ ↔	◎ ←	◎ ←	◎ ←	◎ ←	—
	Combined load radial and axial	○	○	◎	◎	○	△	×	△	△	×	×	◎	◎	△	×	×	×	×	×	×	△	—
	Vibration or impact load	△	△	△	△	△	△	◎	◎	◎	◎	○	◎	◎	◎	△	△	△	○	○	◎	◎	—
High speed adaptability	◎	◎	◎	○	◎	△	◎	◎	◎	◎	○	○	○	○	△	△	○	△	△	△	△	△	A16 A84
High accuracy	◎	◎	◎		◎		◎		◎			○			○		◎						A16, 58 A117
Low noise level/low torque	◎						○																A16
Rigidity			○		○		○	○	○	◎		○	○	◎				○	◎	◎	◎		A16
Misalignment	○	△	×	×	×	◎	△	△	△	△		△	△	◎	×	◎	×	×	×	×	◎		A17 Description before specification table
Inner and outer ring separability	×	×	×	×	■*	×	■	■	■	■		■	■	×	■	■	■	■	■	■*	■	■	—
Arrangement	Fixed side	■ ↔	■ ←	■ ↔	■ ↔*	■ ↔	■ ↔	×	■ ←	■ ↔	×	×	■ ←	■ ↔	■ ↔								A20
	Free side	□		□	□	□	■	□	□	■		■		□	□								A20
Remarks		A pair of bearings mounted facing each other.	*DT arrangement is effective for one direction only.	*Filling slot type is effective for one direction only.	*Non-separable type is also available.								A pair of bearings mounted facing each other.			*Double direction bearings are effective for both directions.				*Non-separable type is also available.			—
Reference page No.	A4 B4	A5 B54		A6 —	A6 B124	A7 B138					A8 B362	A9 B184		A10 B290	A11 B336		— —	A12 B448	A12 B444	A13 —	A13 B354	—	

◎ Excellent ○ Good △ Fair × Unacceptable ↔ Both directions ← One direction only ■ Acceptable □ Acceptable, but shaft shrinkage must be compensated for.

4. Selection of bearing arrangement

As bearing operational conditions vary depending on devices in which bearings are mounted, different performances are demanded of bearings. Normally, two or more bearings are used on one shaft.

In many cases, in order to locate shaft positions in the axial direction, one bearing is mounted on the fixed side first, then the other bearing is mounted on the free side.

Table 4-1 Bearings on fixed and free sides

	Features	Recommended bearing type	Example No.
Fixed side bearing	<ul style="list-style-type: none"> This bearing determines shaft axial position. This bearing can accommodate both radial and axial loads. Since axial load in both directions is imposed on this bearing, strength must be considered in selecting the bearing for this side. 	Deep groove ball bearing Matched pair or stack angular contact ball bearing Double-row angular contact ball bearing Self-aligning ball bearing Cylindrical roller bearing with rib (NUP and NH types) Double-row tapered roller bearing Spherical roller bearing	Examples 1-11
Free side bearing	<ul style="list-style-type: none"> This bearing is employed to compensate for expansion or shrinkage caused by operating temperature change and to allow adjustment of bearing position. Bearings which accommodate radial load only and whose inner and outer rings are separable are recommended as free side bearings. In general, if non-separable bearings are used on free side, clearance fit is provided between outer ring and housing to compensate for shaft movement through bearings. In some cases, clearance fit between shaft and inner ring is utilized. 	<ul style="list-style-type: none"> Separable types Cylindrical roller bearing (NU and N types) Needle roller bearing (NA type, etc.) Non-separable types Deep groove ball bearing Matched pair angular contact ball bearing (Back-to-back arrangement) Double-row angular contact ball bearing Self-aligning ball bearing Double-row tapered roller bearing (TDO type) Spherical roller bearing 	
When fixed and free sides are not distinguished	<ul style="list-style-type: none"> When bearing intervals are short and shaft shrinkage does not greatly affect bearing operation, a pair of angular contact ball bearings or tapered roller bearings is used in paired mounting to accommodate axial load. After mounting, the axial clearance is adjusted using nuts or shims. 	Deep groove ball bearing Angular contact ball bearing Self-aligning ball bearing Cylindrical roller bearing (NJ and NF types) Tapered roller bearing Spherical roller bearing	Examples 12-16
Bearings for vertical shafts	<ul style="list-style-type: none"> Bearings which can accommodate both radial and axial loads should be used on fixed side. Heavy axial load can be accommodated using thrust bearings together with radial bearings. Bearings which can accommodate radial load only are used on free side, compensating for shaft movement. 	<ul style="list-style-type: none"> Fixed side Matched pair angular contact ball bearing (Back-to-back arrangement) Double-row tapered roller bearing (TDO type) Thrust bearing + radial bearing 	Examples 17 and 18

Table 4-2 (1) Example bearing arrangements

Example	Bearing arrangement		Recommended application	Application example
	Fixed side	Free side		
Ex. 1			<ul style="list-style-type: none"> Suitable for high-speed operation; used for various types of applications. Not recommended for applications that have center displacement between bearings or shaft deflection. 	Medium size motors, air blowers
Ex. 2			<ul style="list-style-type: none"> More suitable than Ex. 1 for operation under heavy load or impact load. Suitable also for high-speed operation. Due to separability, suitable for applications requiring interference of both inner and outer rings. Not recommended for applications that have center displacement between bearings or shaft deflection. 	Traction motors for railway rolling stock
Ex. 3			<ul style="list-style-type: none"> Recommended for applications under heavier or greater impact load than those in Ex. 2. This arrangement requires high rigidity from fixed side bearings mounted back to back, with preload provided. Shaft and housing of accurate dimensions should be selected and mounted properly. 	Steel manufacturing table rollers, lathe spindles
Ex. 4			<ul style="list-style-type: none"> This is recommended for operation at high speed or axial load lighter than in Ex. 3. This is recommended for applications requiring interference of both inner and outer rings. Some applications use double-row angular contact ball bearings on fixed side instead of matched pair angular contact ball bearings. 	Motors
Ex. 5			<ul style="list-style-type: none"> This is recommended for operations under relatively small axial load. This is recommended for applications requiring interference of both inner and outer rings. 	Paper manufacturing calender rollers, diesel locomotive axle journals
Ex. 6			<ul style="list-style-type: none"> This is recommended for operations at high speed and heavy radial load, as well as normal axial load. When deep groove ball bearings are used, clearance must be provided between outside diameter and housing, to prevent application of radial load. 	Diesel locomotive transmissions
Ex. 7			<ul style="list-style-type: none"> This arrangement is most widely employed. This arrangement can accommodate partial axial load as well as radial load. 	Pumps, automobile transmissions

Table 4-2 (2) Example bearing arrangements

Example	Bearing arrangement		Recommended application	Application example
	Fixed side	Free side		
Ex. 8			<ul style="list-style-type: none"> This is recommended for operations with relatively heavy axial load in both directions. Some applications use matched pair angular contact ball bearings on fixed side instead of double-row angular contact ball bearings. 	Worm gear speed reducers
Ex. 9			<ul style="list-style-type: none"> This is the optimum arrangement for applications with possible mounting errors or shaft deflection. Bearings in this arrangement can accommodate partial axial load, as well as heavy radial load. 	Steel manufacturing table roller speed reducers, overhead crane wheels
Ex. 10			<ul style="list-style-type: none"> This is optimum arrangement for applications with possible mounting errors or shaft deflection. Ease of mounting and dismounting, ensured by use of adaptor, makes this arrangement suitable for long shafts which are neither stepped nor threaded. This arrangement is not recommended for applications requiring axial load capability. 	General industrial equipment counter shafts
Ex. 11			<ul style="list-style-type: none"> This is the optimum arrangement for applications with possible mounting errors or shaft deflection. This is recommended for operations under impact load or radial load heavier than that in Ex. 10. This arrangement can accommodate partial axial load as well as radial load. 	Steel manufacturing table rollers
Arrangement in which fixed and free sides are not distinguished			Recommended application	Application example
Ex. 12			<ul style="list-style-type: none"> This arrangement is most popular when applied to small equipment operating under light load. When used with light preloading, thickness-adjusted shim or spring is mounted on one side of outer ring. 	Small motors, small speed reducers, small pumps
Ex. 13			<ul style="list-style-type: none"> This is suitable for applications in which rigidity is enhanced by preloading. This is frequently employed in applications requiring high speed operation under relatively large axial load. Back-to-back arrangement is suitable for applications in which moment load affects operation. When preloading is required, care should be taken in preload adjustment. 	Machine tool spindles

Table 4-2 (3) Example bearing arrangements

Example	Arrangement in which fixed and free sides are not distinguished	Recommended application	Application example
Ex. 14		<ul style="list-style-type: none"> This is recommended for operation under impact load or axial load heavier than in Ex. 13. This is suitable for applications in which rigidity is enhanced by preloading. Back-to-back arrangement is suitable for applications in which moment load affects operation. When interference is required between inner ring and shaft, face-to-face arrangement simplifies mounting. This arrangement is effective for applications in which mounting error is possible. When preloading is required, care should be taken in preload adjustment. 	Speed reducers, automobile wheels
Ex. 15		<ul style="list-style-type: none"> This is recommended for applications requiring high speed and high accuracy of rotation under light load. This is suitable for applications in which rigidity is enhanced by preloading. Tandem arrangement and face-to-face arrangement are possible, as is back-to-back arrangement. 	Machine tool spindles
Ex. 16		<ul style="list-style-type: none"> This arrangement provides resistance against heavy radial and impact loads. This is applicable when both inner and outer rings require interference. Care should be taken not to reduce axial internal clearance a critical amount during operation. 	Construction equipment final drive
Application to vertical shafts		Recommended application	Application example
Ex. 17		<ul style="list-style-type: none"> This arrangement, using matched pair angular contact ball bearings on the fixed side and cylindrical roller bearings on the free side, is suitable for high speed operation. 	Vertical motors, vertical pumps
Ex. 18		<ul style="list-style-type: none"> This is recommended for operation at low speed and heavy load, in which axial load is heavier than radial load. Due to self-aligning capability, this is suitable for applications in which shaft runout or deflection occurs. 	Crane center shafts, vertical pumps

5. Selection of bearing dimensions

5-1 Bearing service life

When bearings rotate under load, material flakes from the surfaces of inner and outer rings or rolling elements by fatigue arising from repeated contact stress (ref. A 152).

This phenomenon is called flaking. The total number of bearing rotations until flaking occurs is regarded as the bearing "(fatigue) service life". "(Fatigue) service life" differs greatly depending upon bearing structures, dimensions, materials, and processing methods. Since this phenomenon results from fatigue distribution in bearing materials themselves, differences in bearing service life should be statistically considered.

When a group of identical bearings are rotated under the same conditions, the total number of revolutions until 90 % of the bearings are left without flaking (i.e. a service life of 90 % reliability) is defined as the basic rating life. In operation at a constant speed, the basic rating life can be expressed in terms of time.

In actual operation, a bearing fails not only because of fatigue, but other factors as well, such as wear, seizure, creeping, fretting, brinelling, cracking etc (ref. A 152, 16. Examples of bearing failures).

These bearing failures can be minimized by selecting the proper mounting method and lubricant, as well as the bearing most suitable for the application.

5-2 Calculation of service life

5-2-1 Basic dynamic load rating C

The basic dynamic load rating is either pure radial (for radial bearings) or central axial load (for thrust bearings) of constant magnitude in a constant direction, under which the basic rating life of 1 million revolutions can be obtained, when the inner ring rotates while the outer ring is stationary, or vice versa. The basic dynamic load rating, which represents the capacity of a bearing under rolling fatigue, is specified as the basic dynamic radial load rating (C_r) for radial bearings, and basic dynamic axial load rating (C_a) for thrust bearings. These load ratings are listed in the specification table.

These values are prescribed by ISO 281/1990, and are subject to change by conformance to the latest ISO standards.

5-2-2 Basic rating life L_{10}

The basic rating life L_{10} is a service life of 90 % reliability when used under normal usage conditions for bearings of high manufacturing quality where the inside of the bearing is of a standard design made from bearing steel materials specified in JIS or equivalent materials.

The relationship between the basic dynamic load rating, dynamic equivalent load, and basic rating life of a bearing can be expressed using equation (5-1). This life calculation equation does not apply to bearings that are affected by factors such as plastic deformation of the contact surfaces of raceways and rolling elements due to extremely high load conditions (when P exceeds either the basic static load rating C_0 (refer to p. A 42) or $0.5C$) or, conversely, to bearings that are affected by factors such as the contact surfaces of raceways and rolling elements slipping due to extremely low load conditions.

If conditions like these may be encountered, consult with JTEKT.

It is convenient to express the basic rating life in terms of time, using equation (5-2), when a bearing is used for operation at a constant speed; and, in terms of traveling distance (km), using equation (5-3), when a bearing is used in railway rolling stock or automobiles.

$$\left(\begin{matrix} \text{Total} \\ \text{revolutions} \end{matrix} \right) L_{10} = \left(\frac{C}{P} \right)^p \dots\dots\dots(5-1)$$

$$\left(\begin{matrix} \text{Time} \\ \text{h} \end{matrix} \right) L_{10h} = \frac{10^6}{60n} \left(\frac{C}{P} \right)^p \dots\dots\dots(5-2)$$

$$\left(\begin{matrix} \text{Running} \\ \text{distance} \end{matrix} \right) L_{10s} = \pi D L_{10} \dots\dots\dots(5-3)$$

- where :
- L_{10} : basic rating life 10^6 revolutions
 - L_{10h} : basic rating life h
 - L_{10s} : basic rating life km
 - P : dynamic equivalent load N
 - C : basic dynamic load rating N
 - n : rotational speed min^{-1}
 - p : for ball bearings..... $p = 3$
 - for roller bearings..... $p = 10/3$
 - D : wheel or tire diameter mm
-(refer to p. A 38.)

Accordingly, where the dynamic equivalent load is P , and rotational speed is n , equation (5-4) can be used to calculate the basic dynamic load rating C ; the bearing size most suitable for a specified purpose can then be selected, referring to the bearing specification table.

The recommended bearing service life differs depending on the machines with which the bearing is used, as shown in Table 5-5, p. A 31.

$$C = P \left(L_{10h} \times \frac{60n}{10^6} \right)^{1/p} \dots\dots\dots(5-4)$$

[Reference] The equations using a service life coefficient (f_h) and rotational speed coefficient (f_n) respectively, based on equation (5-2), are as follows :

$$L_{10h} = 500 f_h^p \dots\dots\dots(5-5)$$

Coefficient of service life :

$$f_h = f_n \frac{C}{P} \dots\dots\dots(5-6)$$

Coefficient of rotational speed :

$$f_n = \left(\frac{10^6}{500 \times 60n} \right)^{1/p} = (0.03n)^{-1/p} \dots\dots\dots(5-7)$$

For reference, the values of f_n , f_h , and L_{10h} can be easily obtained by employing the nomograph attached to this catalog, as an abbreviated method.

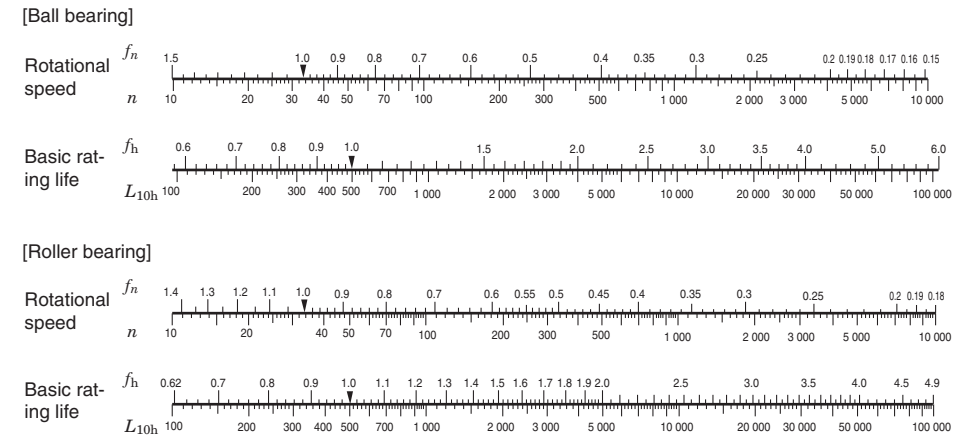

[Reference] Rotational speed (n) and its coefficients (f_n), and service life coefficient (f_h) and basic rating life (L_{10h})

5-2-3 Correction of basic dynamic load rating for high temperature use and dimension stabilizing treatment

In high temperature operation, bearing material hardness deteriorates, as material compositions are altered. As a result, the basic dynamic load rating is diminished. Once altered, material composition is not recovered, even if operating temperatures return to normal.

Therefore, for bearings used in high temperature operation, the basic dynamic load rating should be corrected by multiplying the basic dynamic load rating values specified in the bearing specification table by the temperature coefficient values in Table 5-1.

Table 5-1 Temperature coefficient values

Bearing temperature, °C	125	150	175	200	250
Temperature coefficient	1	1	0.95	0.90	0.75

Since normal heat treatment is not effective in maintaining the original bearing size in extended operation at 120 °C or higher, dimension stabilizing treatment is necessary. Dimension stabilizing treatment codes and their effective temperature ranges are described in Table 5-2.

Since dimension stabilizing treatment diminishes material hardness, the basic dynamic load rating may be reduced for some types of bearings.

Table 5-2 Dimension stabilizing treatment

Dimension stabilizing treatment code	Effective temperature range
S0	Over 100°C, up to 150°C
S1	150°C 200°C
S2	200°C 250°C

5-2-4 Modified rating life L_{nm}

The life of rolling bearings was standardized as a basic rating life in the 1960s, but in actual applications, sometimes the actual life and the basic rating life have been quite different due to the lubrication status and the influence of the usage environment. To make the calculated life closer to the actual life, a corrected rating life has been considered since the 1980s. In this corrected rating life, bearing characteristic factor a_2 (a correction factor for the case in which the characteristics related to the life are changed due to the bearing materials, manufacturing process, and design) and usage condition factor a_3 (a correction factor that takes into account usage conditions that have a direct influence on the bearing life, such as the lubrication) or factor a_{23} formed from the interdependence of these two factors, are considered with the basic rating life. These factors were handled differently by each bearing manufacturer, but they have been standardized as a modified rating life in **ISO 281** in 2007. In 2013, **JIS B 1518** (dynamic load ratings and rating life) was amended to conform to the **ISO**.

The basic rating life (L_{10}) shown in equation (5-1) is the (fatigue) life with a dependability of 90 % under normal usage conditions for rolling bearings that have standard factors such as internal design, materials, and manufacturing quality. **JIS B 1518:2013** specifies a calculation method based on **ISO 281:2007**. To calculate accurate bearing life under a variety of operating conditions, it is necessary to consider elements such as the effect of changes in factors that can be anticipated when using different reliabilities and system approaches, and interactions between factors. Therefore, the specified calculation method considers additional stress due to the lubrication status, lubricant contamination, and fatigue load limit C_u (refer to p. A 29) on the inside of the bearing. The life that uses this life modification factor a_{ISO} , which considers the above factors, is called modified rating life L_{nm} and is calculated with the following equation (5-8).

$$L_{nm} = a_1 a_{ISO} L_{10} \dots\dots\dots (5-8)$$

In this equation,

L_{nm} : Modified rating life 10⁶ rotations
 (This rating life has been modified for one of or a combination of the following: reliability of 90 % or higher, fatigue load limit, special bearing characteristics, lubrication contamination, and special operating conditions.)

L_{10} : Basic rating life 10⁶ rotations (reliability: 90 %)

a_1 : Life modification factor for reliability
 refer to section (1)

a_{ISO} : Life modification factor
 refer to section (2)

[Remark]

When bearing dimensions are to be selected given L_{nm} greater than 90 % in reliability, the strength of shaft and housing must be considered.

(1) Life modification factor for reliability a_1

The term “reliability” is defined as “for a group of apparently identical rolling bearings, operating under the same conditions, the percentage of the group that is expected to attain or exceed a specified life” in **ISO 281:2007**. Values of a_1 used to calculate a modified rating life with a reliability of 90 % or higher (a failure probability of 10 % or less) are shown in Table 5-3.

Table 5-3 Life modification factor for reliability a_1

Reliability, %	L_{nm}	a_1
90	L_{10m}	1
95	L_{5m}	0.64
96	L_{4m}	0.55
97	L_{3m}	0.47
98	L_{2m}	0.37
99	L_{1m}	0.25
99.2	$L_{0.8m}$	0.22
99.4	$L_{0.6m}$	0.19
99.6	$L_{0.4m}$	0.16
99.8	$L_{0.2m}$	0.12
99.9	$L_{0.1m}$	0.093
99.92	$L_{0.08m}$	0.087
99.94	$L_{0.06m}$	0.080
99.95	$L_{0.05m}$	0.077

(Citation from **JIS B 1518:2013**)

(2) Life modification factor a_{ISO}

a) System approach

The various influences on bearing life are dependent on each other. The system approach of calculating the modified life has been evaluated as a practical method for determining life modification factor a_{ISO} (ref. Fig. 5-1). Life modification factor a_{ISO} is calculated with the following equation. A diagram is available for each bearing type (radial ball bearings, radial roller bearings, thrust ball bearings, and thrust roller bearings). (Each diagram (Figs. 5-2 to 5-5) is a citation from **JIS B 1518:2013**.)

Note that in practical use, this is set so that life modification factor $a_{ISO} \leq 50$.

$$a_{ISO} = f\left(\frac{e_c C_u}{P}, \kappa\right) \dots\dots\dots (5-9)$$

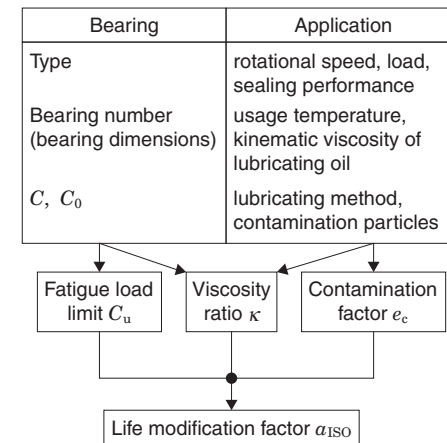

Fig. 5-1 System approach

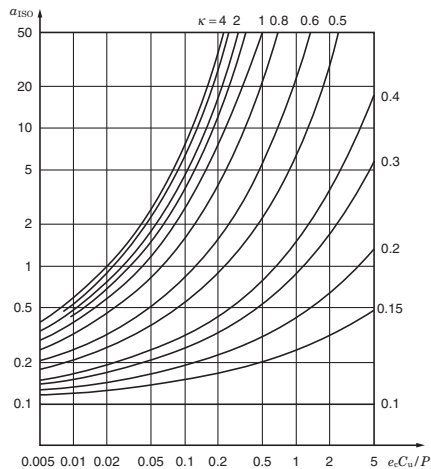

Fig. 5-2 Life modification factor a_{ISO} (Radial ball bearings)

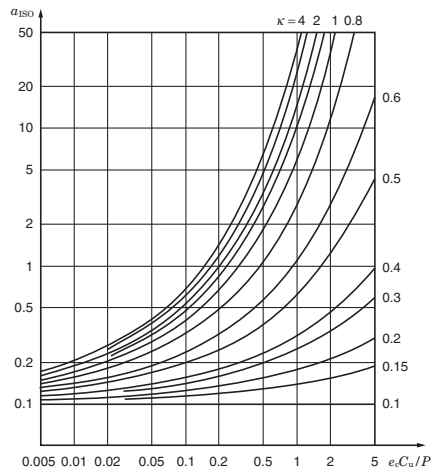

Fig. 5-3 Life modification factor a_{ISO} (Radial roller bearings)

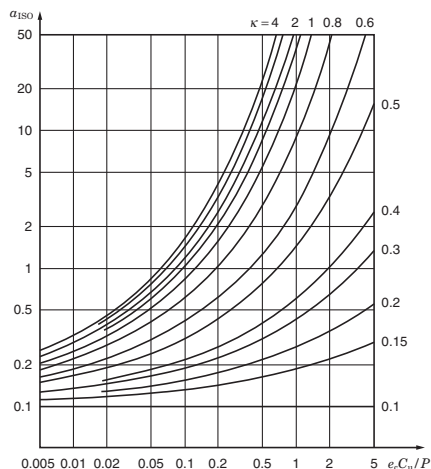

Fig. 5-4 Life modification factor a_{ISO} (Thrust ball bearings)

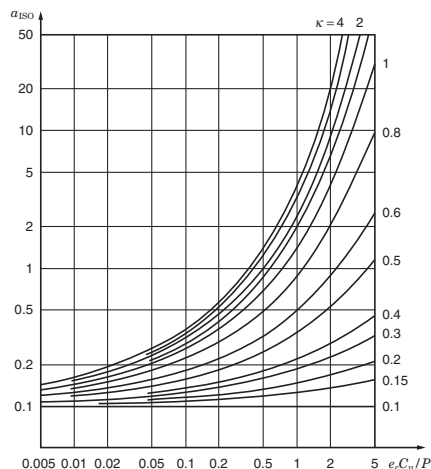

Fig. 5-5 Life modification factor a_{ISO} (Thrust roller bearings)

(Figs. 5-2 to 5-5 Citation from JIS B 1518:2013)

b) Fatigue load limit C_u

For regulated steel materials or alloy steel that has equivalent quality, the fatigue life is unlimited so long as the load condition does not exceed a certain value and so long as the lubrication conditions, lubrication cleanliness class, and other operating conditions are favorable. For general high-quality materials and bearings with high manufacturing quality, the fatigue stress limit is reached at a contact stress of approximately 1.5 GPa between the raceway and rolling elements. If one or both of the material quality and manufacturing quality are low, the fatigue stress limit will also be low.

The term “fatigue load limit” C_u is defined as “bearing load under which the fatigue stress limit is just reached in the most heavily loaded raceway contact” in ISO 281:2007, and is affected by factors such as the bearing type, size, and material.

For details on the fatigue load limits of special bearings and other bearings not listed in this catalog, contact JTEKT.

c) Contamination factor e_c

If solid particles in the contaminated lubricant are caught between the raceway and the rolling elements, indentations may form on one or both of the raceway and the rolling elements. These indentations will lead to localized increases in stress, which will decrease the life. This decrease in life attributable to the contamination of the lubricant can be calculated from the contamination level as contamination factor e_c .

D_{pw} shown in this table is the pitch diameter of ball/roller set, which is expressed simply as $D_{pw} = (D + d)/2$. (D : Outside diameter, d : Bore diameter)

For information such as details on special lubricating conditions or detailed investigations, contact JTEKT.

Table 5-4 Values of contamination factor e_c

Contamination level	e_c	
	$D_{pw} < 100 \text{ mm}$	$D_{pw} \geq 100 \text{ mm}$
Extremely high cleanliness: The size of the particles is approximately equal to the thickness of the lubricant oil film, this is found in laboratory-level environments.	1	1
High cleanliness: The oil has been filtered by an extremely fine filter, this is found with standard grease-packed bearings and sealed bearings.	0.8 to 0.6	0.9 to 0.8
Standard cleanliness: The oil has been filtered by a fine filter, this is found with standard grease-packed bearings and shielded bearings.	0.6 to 0.5	0.8 to 0.6
Minimal contamination: The lubricant is slightly contaminated.	0.5 to 0.3	0.6 to 0.4
Normal contamination: This is found when no seal is used and a coarse filter is used in an environment in which wear debris and particles from the surrounding area penetrate into the lubricant.	0.3 to 0.1	0.4 to 0.2
High contamination: This is found when the surrounding environment is considerably contaminated and the bearing sealing is insufficient.	0.1 to 0	0.1 to 0
Extremely high contamination	0	0

(Table 5-4 Citation from JIS B 1518:2013)

d) Viscosity ratio κ

The lubricant forms an oil film on the roller contact surface, which separates the raceway and the rolling elements. The status of the lubricant oil film is expressed by viscosity ratio κ , the actual kinematic viscosity at the operating temperature ν divided by the reference kinematic viscosity ν_1 as shown in the following equation.

A κ greater than 4, equal to 4, or less than 0.1 is not applicable.

For details on lubricants such as grease and lubricants with extreme pressure additives, contact JTEKT.

$$\kappa = \frac{\nu}{\nu_1} \dots\dots\dots (5-10)$$

ν : Actual kinematic viscosity at the operating temperature; the viscosity of the lubricant at the operating temperature (refer to Fig. 12-3, p. A129)

ν_1 : Reference kinematic viscosity; determined according to the speed and pitch diameter of ball/roller set D_{pw} of the bearing (ref. Fig. 5-6)

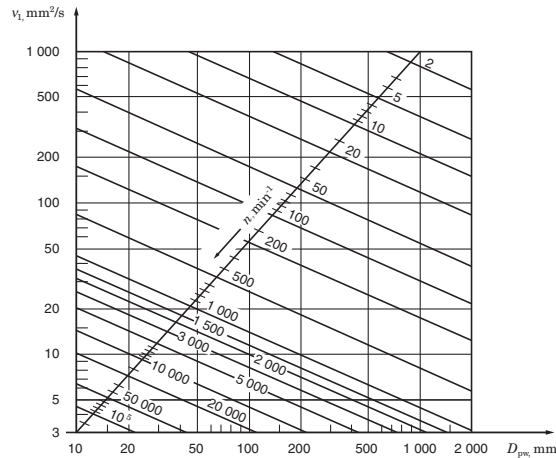

(Fig. 5-6 Citation from JIS B 1518:2013)

Fig. 5-6 Reference kinematic viscosity v_1

5-2-5 Service life of bearing system comprising two or more bearings

Even for systems which comprise two or more bearings, if one bearing is damaged, the entire system malfunctions.

Where all bearings used in an application are regarded as one system, the service life of the bearing system can be calculated using the following equation,

$$\frac{1}{L^e} = \frac{1}{L_1^e} + \frac{1}{L_2^e} + \frac{1}{L_3^e} + \dots \dots \dots (5-11)$$

where :

- L : rating life of system
- L_1, L_2, L_3, \dots : rating life of each bearing
- e : constant

($e = 10/9$ball bearing
 $e = 9/8$roller bearing
 The mean value is for a system using both ball and roller bearings.)

[Example]

When a shaft is supported by two roller bearings whose service lives are 50 000 hours and 30 000 hours respectively, the rating life of the bearing system supporting this shaft is calculated as follows, using equation (5-11) :

$$\frac{1}{L^{9/8}} = \frac{1}{50\,000^{9/8}} + \frac{1}{30\,000^{9/8}}$$

$$L \doteq 20\,000 \text{ h}$$

The equation suggests that the rating life of these bearings as a system becomes shorter than that of the bearing with the shorter life.

This fact is very important in estimating bearing service life for applications using two or more bearings.

5-2-6 Applications and recommended bearing service life

Since longer service life does not always contribute to economical operation, the most suitable service life for each application and operating conditions should be determined.

For reference, Table 5-5 describes recommended service life in accordance with the application, as empirically determined.

Table 5-5 Recommended bearing service life (reference)

Operating condition	Application	Recommended service life (h)
Short or intermittent operation	Household electric appliance, electric tools, agricultural equipment, heavy cargo hoisting equipment	4 000 – 8 000
Not extended duration, but stable operation required	Household air conditioner motors, construction equipment, conveyers, elevators	8 000 – 12 000
Intermittent but extended operation	Rolling mill roll necks, small motors, cranes	8 000 – 12 000
	Motors used in factories, general gears	12 000 – 20 000
	Machine tools, shaker screens, crushers	20 000 – 30 000
	Compressors, pumps, gears for essential use	40 000 – 60 000
Daily operation more than 8 hr. or continuous extended operation	Escalators	12 000 – 20 000
	Centrifugal separators, air conditioners, air blowers, woodworking equipment, passenger coach axle journals	20 000 – 30 000
	Large motors, mine hoists, locomotive axle journals, railway rolling stock traction motors	40 000 – 60 000
	Paper manufacturing equipment	100 000 – 200 000
24 hr. operation (no failure allowed)	Water supply facilities, power stations, mine water discharge facilities	100 000 – 200 000

5-3 Calculation of loads

Loads affecting bearings includes force exerted by the weight of the object the bearings support, transmission force of devices such as gears and belts, loads generated in equipment during operation etc.

Seldom can these kinds of load be determined by simple calculation, because the load is not always constant.

In many cases, the load fluctuates, and it is difficult to determine the frequency and magnitude of the fluctuation.

Therefore, loads are normally obtained by multiplying theoretical values with various coefficients obtained empirically.

5-3-1 Load coefficient

Even if radial and axial loads are obtained through general dynamic calculation, the actual load becomes greater than the calculated value due to vibration and impact during operation.

In many cases, the load is obtained by multiplying theoretical values by the load coefficient.

$$F = f_w \cdot F_c \dots\dots\dots (5-12)$$

where :

- F : measured load N
- F_c : calculated load N
- f_w : load coefficient (ref. Table 5-6)

5-3-2 Load generated through belt or chain transmission

In the case of belt transmission, the theoretical value of the load affecting the pulley shafts can be determined by obtaining the effective transmission force of the belt.

For actual operation, the load is obtained by multiplying this effective transmission force by the load coefficient (f_w) considering vibration and impact generated during operation, and the belt coefficient (f_b) considering belt tension.

In the case of chain transmission, the load is determined using a coefficient equivalent to the belt coefficient.

This equation (5-13) is as follows ;

$$F_b = \frac{2M}{D_p} \cdot f_w \cdot f_b$$

$$= \frac{19.1 \times 10^6 W}{D_p n} \cdot f_w \cdot f_b \dots\dots\dots (5-13)$$

where :

- F_b : estimated load affecting pulley shaft or sprocket shaft N
- M : torque affecting pulley or sprocket mN · m
- W : transmission force kW
- D_p : pitch circle diameter of pulley or sprocket mm
- n : rotational speed min⁻¹
- f_w : load coefficient (ref. Table 5-6)
- f_b : belt coefficient (ref. Table 5-7)

Table 5-6 Values of load coefficient f_w

Operating condition	Application example	f_w
Operation with little vibration or impact	Motors Machine tools Measuring instrument	1.0 – 1.2
Normal operation (slight impact)	Railway rolling stock Automobiles Paper manufacturing equipment Air blowers Compressors Agricultural equipment	1.2 – 2.0
Operation with severe vibration or impact	Rolling mills Crushers Construction equipment Shaker screens	2.0 – 3.0

Table 5-7 Values of belt coefficient f_b

Belt type	f_b
Timing belt (with teeth)	1.3 – 2.0
V-belt	2.0 – 2.5
Flat belt (with tension pulley)	2.5 – 3.0
Flat belt	4.0 – 5.0
Chain	1.2 – 1.5

5-3-3 Load generated under gear transmission

(1) Loads affecting gear and gear coefficient

In the case of gear transmission, loads transmitted by gearing are theoretically classified into three types: tangential load (K_t), radial load (K_r) and axial load (K_a).

Those loads can be calculated dynamically (using equations ㉑, ㉒ and ㉓, described in section (2)).

To determine the actual gear loads, these theoretical loads must be multiplied by coefficients considering vibration and impact during operation (f_w) (ref. Table 5-6) and the gear coefficient (f_g) (ref. Table 5-8) considering the finish treatment of gears.

Table 5-8 Values of gear coefficient f_g

Gear type	f_g
Precision gears (both pitch error and tooth shape error less than 0.02 mm)	1.0 – 1.1
Normal gears (both pitch error and tooth shape error less than 0.1 mm)	1.1 – 1.3

(2) Calculation of load on gears

㉑ Tangential load (tangential force) K_t
(Spur gears, helical gears, double-helical gears, straight bevel gears, spiral bevel gears)
$K_t = \frac{2M}{D_p} = \frac{19.1 \times 10^6 W}{D_p n}$ (5-14)

㉑-㉓ where :

K_t : gear tangential load	N
K_r : gear radial load	N
K_a : gear axial load	N
M : torque affecting gears	mN · m
D_p : gear pitch circle diameter	mm
W : transmitting force	kW
n : rotational speed	min ⁻¹
α : gear pressure angle	deg
β : gear helix (spiral) angle	deg
δ : bevel gear pitch angle	deg

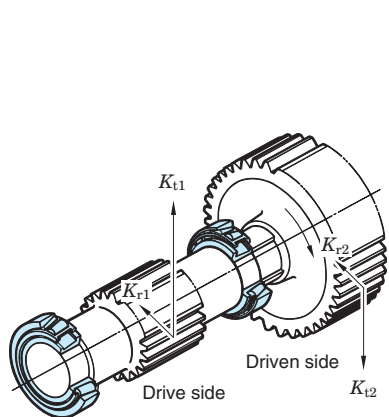

Fig. 5-7 Load on spur gears

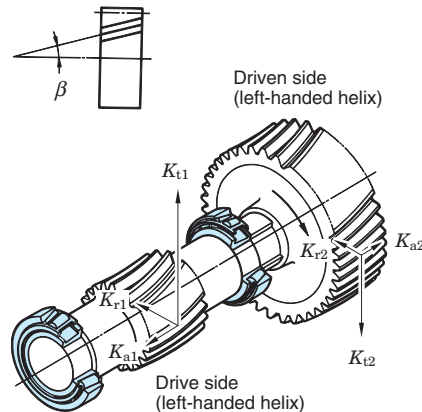

Fig. 5-8 Load on helical gears

	㉒ Radial load (separating force) K_r	㉓ Axial load (axial force) K_a
Spur gears	$K_r = K_t \tan \alpha$ (5-15)	0
Helical gears	$K_r = K_t \frac{\tan \alpha}{\cos \beta}$ (5-16)	$K_a = K_t \tan \beta$ (5-22)
Double-helical gears	$K_r = K_t \frac{\tan \alpha}{\cos \beta}$ (5-17)	0
Straight ¹⁾ bevel gears	Drive side: $K_{r1} = K_t \tan \alpha \cos \delta_1$ (5-18)	$K_{a1} = K_t \tan \alpha \sin \delta_1$ (5-23)
	Driven side: $K_{r2} = K_t \tan \alpha \cos \delta_2$ (5-19)	$K_{a2} = K_t \tan \alpha \sin \delta_2$ (5-24)
Spiral ^{1), 2)} bevel gears	Drive side: $K_{r1} = \frac{K_t}{\cos \beta} (\tan \alpha \cos \delta_1 \pm \sin \beta \sin \delta_1)$ (5-20)	$K_{a1} = \frac{K_t}{\cos \beta} (\tan \alpha \sin \delta_1 \mp \sin \beta \cos \delta_1)$ (5-25)
	Driven side: $K_{r2} = \frac{K_t}{\cos \beta} (\tan \alpha \cos \delta_2 \mp \sin \beta \sin \delta_2)$ (5-21)	$K_{a2} = \frac{K_t}{\cos \beta} (\tan \alpha \sin \delta_2 \pm \sin \beta \cos \delta_2)$ (5-26)

[Notes] 1) Codes with subscript 1 and 2 shown in equations are respectively applicable to drive side gears and driven side gears.

2) Symbols (+) and (-) denote the following ;

- Symbols in upper row : clockwise rotation accompanied by right-handed spiral or counterclockwise rotation with left-handed spiral
- Symbols in lower row : counterclockwise rotation with right-handed spiral or clockwise rotation with left-handed spiral

[Remark] Rotating directions are described as viewed at the back of the apex of the pitch angle.

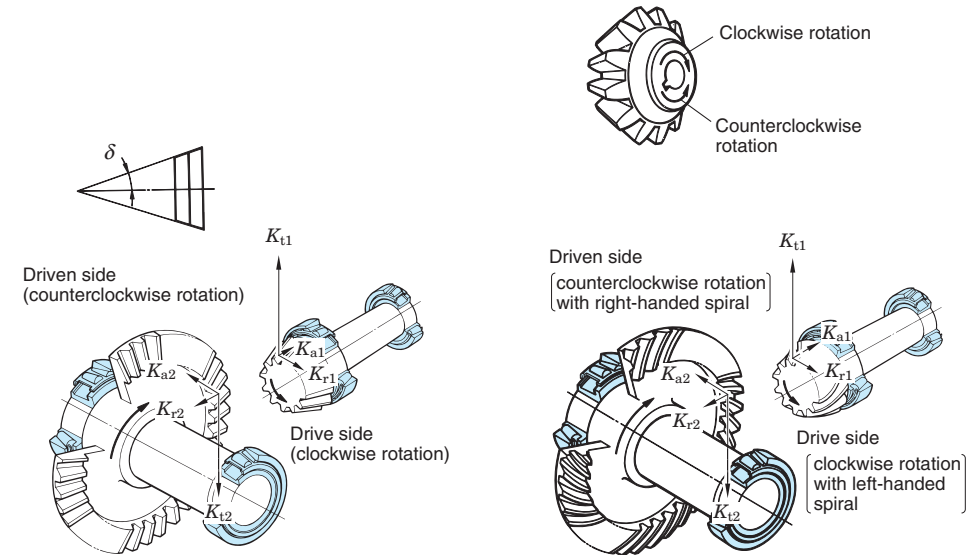

Fig. 5-9 Load on straight bevel gears

Fig. 5-10 Load on spiral bevel gears

5-3-4 Load distribution on bearings

The load distribution affecting bearings can be calculated as follows: first, radial force components are calculated, then, the sum of vectors of the components is obtained in accordance with the load direction.

Calculation examples of radial load distribution are described in the following section.

[Remark]

Bearings shown in Exs. 3 to 5 are affected by components of axial force when these bearings accommodate radial load, and axial load (K_a) which is transferred externally, i.e. from gears.

For calculation of the axial load in this case, refer to page A 38.

Example 1 Fundamental calculation (1)

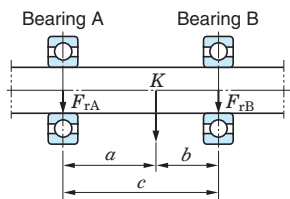

$$F_{rA} = \frac{b}{c} K$$

$$F_{rB} = \frac{a}{c} K$$

..... (5-27)

Example 2 Fundamental calculation (2)

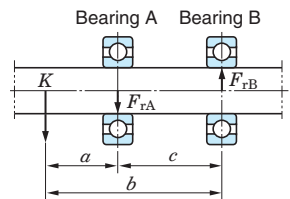

$$F_{rA} = \frac{b}{c} K$$

$$F_{rB} = \frac{a}{c} K$$

..... (5-28)

Example 3 Gear load distribution (1)

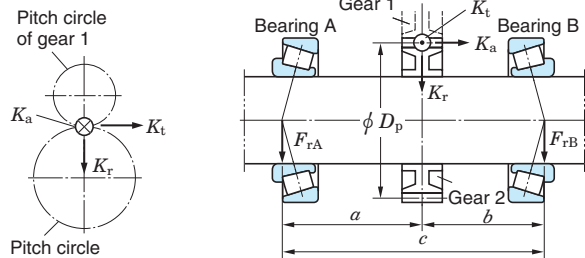

$$F_{rA} = \sqrt{\left(\frac{b}{c} K_t\right)^2 + \left(\frac{b}{c} K_r - \frac{D_p}{2c} K_a\right)^2}$$

$$F_{rB} = \sqrt{\left(\frac{a}{c} K_t\right)^2 + \left(\frac{a}{c} K_r + \frac{D_p}{2c} K_a\right)^2}$$

..... (5-29)

Example 4 Gear load distribution (2)

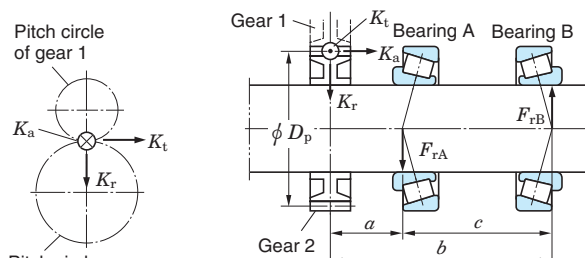

$$F_{rA} = \sqrt{\left(\frac{b}{c} K_t\right)^2 + \left(\frac{b}{c} K_r - \frac{D_p}{2c} K_a\right)^2}$$

$$F_{rB} = \sqrt{\left(\frac{a}{c} K_t\right)^2 + \left(\frac{a}{c} K_r - \frac{D_p}{2c} K_a\right)^2}$$

..... (5-30)

Description of signs in Examples 1 to 5

F_{rA} : radial load on bearing A	N	D_p : gear pitch circle diameter	mm
F_{rB} : radial load on bearing B	N	\odot : denotes load direction (upward perpendicular to paper surface)	
K : shaft load	N	\otimes : denotes load direction (downward perpendicular to paper surface)	
K_t, K_r, K_a : gear load (ref. A 34)	N		

Example 5 Simultaneous application of gear load and other load

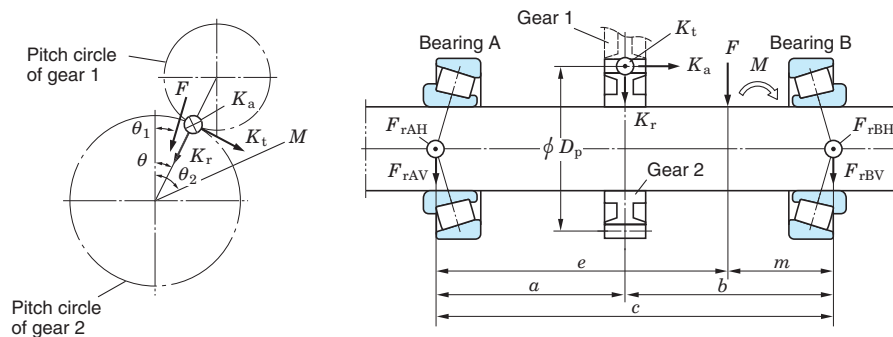

(Gears 1 and 2 are engaged with each other at angle θ . External load F , moment M , are applied to these gears at angles θ_1 and θ_2 .)

- Perpendicular radial component force (upward and downward along diagram)

$$F_{rAV} = \frac{b}{c} (K_r \cos \theta + K_t \sin \theta) - \frac{D_p}{2c} K_a \cos \theta + \frac{m}{c} F \cos \theta_1 - \frac{M}{c} \cos \theta_2$$

$$F_{rBV} = \frac{a}{c} (K_r \cos \theta + K_t \sin \theta) + \frac{D_p}{2c} K_a \cos \theta + \frac{e}{c} F \cos \theta_1 + \frac{M}{c} \cos \theta_2$$

- Horizontal radial component force (upward and downward perpendicular to diagram)

$$F_{rAH} = \frac{b}{c} (K_r \sin \theta - K_t \cos \theta) - \frac{D_p}{2c} K_a \sin \theta + \frac{m}{c} F \sin \theta_1 - \frac{M}{c} \sin \theta_2$$

$$F_{rBH} = \frac{a}{c} (K_r \sin \theta - K_t \cos \theta) + \frac{D_p}{2c} K_a \sin \theta + \frac{e}{c} F \sin \theta_1 + \frac{M}{c} \sin \theta_2$$

- Combined radial force

$$F_{rA} = \sqrt{F_{rAV}^2 + F_{rAH}^2}$$

$$F_{rB} = \sqrt{F_{rBV}^2 + F_{rBH}^2}$$

..... (5-31) (When θ, F , and M are zero, the same result as in Ex. 3 is obtained)

5-4 Dynamic equivalent load

Bearings are used under various operating conditions; however, in most cases, bearings receive radial and axial load combined, while the load magnitude fluctuates during operation.

Therefore, it is impossible to directly compare the actual load and basic dynamic load rating.

The two are compared by replacing the loads applied to the shaft center with one of a constant magnitude and in a specific direction, that yields the same bearing service life as under actual load and rotational speed.

This theoretical load is referred to as the dynamic equivalent load (P).

5-4-1 Calculation of dynamic equivalent load

Dynamic equivalent loads for radial bearings and thrust bearings ($\alpha \neq 90^\circ$) which receive a combined load of a constant magnitude in a specific direction can be calculated using the following equation,

$$P = XF_r + YF_a \quad (5-32)$$

where :

- P : dynamic equivalent load N
- F_r : radial load N
- F_a : axial load N
- X : radial load factor
- Y : axial load factor

(values of X and Y are listed in the bearing specification table.)

- When $F_a/F_r \leq e$ for single-row radial bearings, it is taken that $X = 1$, and $Y = 0$. Hence, the dynamic equivalent load rating is $P_r = F_r$.

(Values of e , which designates the limit of F_a/F_r , are listed in the bearing specification table.)

- For single-row angular contact ball bearings and tapered roller bearings, axial component forces (F_{ac}) are generated as shown in Fig. 5-11, therefore a pair of bearings is arranged face-to-face or back-to-back.

The axial component force can be calculated using the following equation.

$$F_{ac} = \frac{F_r}{2Y} \quad (5-33)$$

Table 5-9 describes the calculation of the dynamic equivalent load when radial loads and external axial loads (K_a) are applied to bearings.

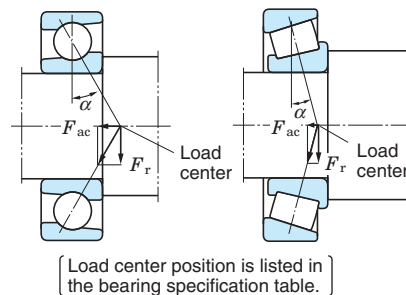

Fig. 5-11 Axial component force

- For thrust ball bearings with contact angle $\alpha = 90^\circ$, to which an axial load is applied, $P_a = F_a$.

- The dynamic equivalent load of spherical thrust roller bearing can be calculated using the following equation.

$$P_a = F_a + 1.2F_r \quad (5-34)$$

where : $F_r/F_a \leq 0.55$

Table 5-9 Dynamic equivalent load calculation : when a pair of single-row angular contact ball bearings or tapered roller bearings is arranged face-to-face or back-to-back.

Paired mounting		Loading condition	Bearing	Axial load	Dynamic equivalent load
Back-to-back arrangement	Face-to-face arrangement				
		$\frac{F_{rB}}{2Y_B} + K_a \geq \frac{F_{rA}}{2Y_A}$	Bearing A	$\frac{F_{rB}}{2Y_B} + K_a$	$P_A = XF_{rA} + Y_A \left(\frac{F_{rB}}{2Y_B} + K_a \right)$ $P_A = F_{rA}$, where $P_A < F_{rA}$
			Bearing B	-	$P_B = F_{rB}$
		$\frac{F_{rB}}{2Y_B} + K_a < \frac{F_{rA}}{2Y_A}$	Bearing A	-	$P_A = F_{rA}$
			Bearing B	$\frac{F_{rA}}{2Y_A} - K_a$	$P_B = XF_{rB} + Y_B \left(\frac{F_{rA}}{2Y_A} - K_a \right)$ $P_B = F_{rB}$, where $P_B < F_{rB}$
		$\frac{F_{rB}}{2Y_B} \leq \frac{F_{rA}}{2Y_A} + K_a$	Bearing A	-	$P_A = F_{rA}$
			Bearing B	$\frac{F_{rA}}{2Y_A} + K_a$	$P_B = XF_{rB} + Y_B \left(\frac{F_{rA}}{2Y_A} + K_a \right)$ $P_B = F_{rB}$, where $P_B < F_{rB}$
		$\frac{F_{rB}}{2Y_B} > \frac{F_{rA}}{2Y_A} + K_a$	Bearing A	$\frac{F_{rB}}{2Y_B} - K_a$	$P_A = XF_{rA} + Y_A \left(\frac{F_{rB}}{2Y_B} - K_a \right)$ $P_A = F_{rA}$, where $P_A < F_{rA}$
			Bearing B	-	$P_B = F_{rB}$

[Remarks] 1. These equations can be used when internal clearance and preload during operation are zero.
2. Radial load is treated as positive in the calculation, if it is applied in a direction opposite that shown in Fig. in Table 5-9.

5-4-2 Mean dynamic equivalent load

When load magnitude or direction varies, it is necessary to calculate the mean dynamic equivalent load, which provides the same length of bearing service life as that under the actual load fluctuation.

The mean dynamic equivalent load (P_m) under different load fluctuations is described using Graphs (1) to (4).

As shown in Graph (5), the mean dynamic equivalent load under stationary and rotating load applied simultaneously, can be obtained using equation (5-39).

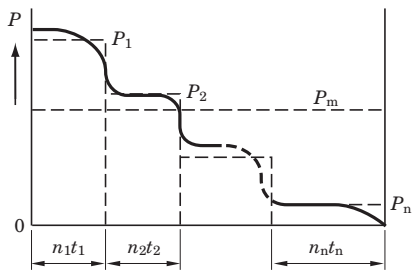
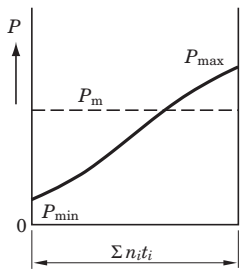
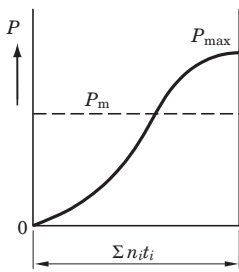
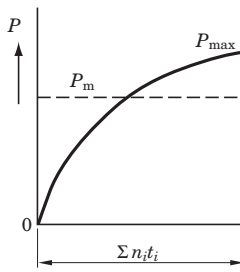
(1) Staged fluctuation	(2) Stageless fluctuation	(3) Fluctuation forming sine curve	(4) Fluctuation forming sine curve (upper half of sine curve)
			
$P_m = \sqrt[p]{\frac{P_1^p n_1 t_1 + P_2^p n_2 t_2 + \dots + P_n^p n_n t_n}{n_1 t_1 + n_2 t_2 + \dots + n_n t_n}} \dots (5-35)$	$P_m = \frac{P_{\min} + 2 P_{\max}}{3} \dots (5-36)$	$P_m = 0.68 P_{\max} \dots (5-37)$	$P_m = 0.75 P_{\max} \dots (5-38)$

Symbols for Graphs (1) to (4)

P_m	: mean dynamic equivalent load	N
P_1	: dynamic equivalent load applied for t_1 hours at rotational speed n_1	N
P_2	: dynamic equivalent load applied for t_2 hours at rotational speed n_2	N
\vdots	\vdots	\vdots
P_n	: dynamic equivalent load applied for t_n hours at rotational speed n_n	N
P_{\min}	: minimum dynamic equivalent load	N
P_{\max}	: maximum dynamic equivalent load	N
$\Sigma n_i t_i$: total rotation in (t_1 to t_i) hours	
p	: for ball bearings, $p = 3$ for roller bearings, $p = 10/3$	

[Reference] Mean rotational speed n_m can be calculated using the following equation :

$$n_m = \frac{n_1 t_1 + n_2 t_2 + \dots + n_n t_n}{t_1 + t_2 + \dots + t_n}$$

(5) Stationary load and rotating load acting simultaneously

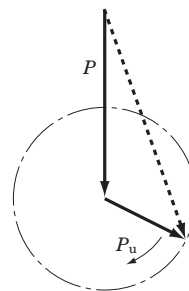

$$P_m = f_m (P + P_u) \dots (5-39)$$

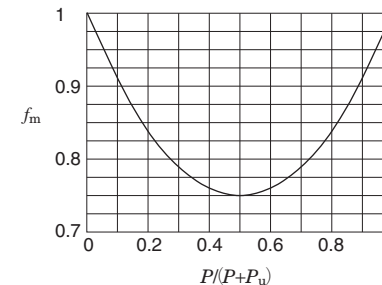

Fig. 5-12 Coefficient f_m

where :

P_m	: mean dynamic equivalent load	N
f_m	: coefficient (refer. Fig. 5-12)	
P	: stationary load	N
P_u	: rotating load	N

5-5 Basic static load rating and static equivalent load

5-5-1 Basic static load rating

Excessive static load or impact load even at very low rotation causes partial permanent deformation of the rolling element and raceway contacting surfaces. This permanent deformation increases with the load; if it exceeds a certain limit, smooth rotation will be hindered.

The basic static load rating is the static load which responds to the calculated contact stress shown below, at the contact center between the raceway and rolling elements which receive the maximum load.

- Self-aligning ball bearings ... 4 600 MPa
- Other ball bearings 4 200 MPa
- Roller bearings 4 000 MPa

The total extent of contact stress-caused permanent deformation on surfaces of rolling elements and raceway will be approximately 0.000 1 times greater than the rolling element diameter.

The basic static load rating for radial bearings is specified as the basic static radial load rating, and for thrust bearings, as the basic static axial load rating. These load ratings are listed in the bearing specification table, using C_{0r} and C_{0a} respectively.

These values are prescribed by ISO 78/1987 and are subject to change by conformance to the latest ISO standards.

5-5-2 Static equivalent load

The static equivalent load is a theoretical load calculated such that, during rotation at very low speed or when bearings are stationary, the same contact stress as that imposed under actual loading condition is generated at the contact center between raceway and rolling element to which the maximum load is applied.

For radial bearings, radial load passing through the bearing center is used for the calculation; for thrust bearings, axial load in a direction along the bearing axis is used.

The static equivalent load can be calculated using the following equations.

[Radial bearings]

...The greater value obtained by the following two equations is used.

$$P_{0r} = X_0 F_r + Y_0 F_a \quad (5-40)$$

$$P_{0r} = F_r \quad (5-41)$$

[Thrust bearings]

($\alpha \neq 90^\circ$)

$$P_{0a} = X_0 F_r + F_a \quad (5-42)$$

[When $F_a < X_0 F_r$, the solution becomes less accurate.]

($\alpha = 90^\circ$)

$$P_{0a} = F_a \quad (5-43)$$

where :

P_{0r} : static equivalent radial load N

P_{0a} : static equivalent axial load N

F_r : radial load N

F_a : axial load N

X_0 : static radial load factor

Y_0 : static axial load factor

(values of X_0 and Y_0 are listed in the bearing specification table.)

5-5-3 Safety coefficient

The allowable static equivalent load for a bearing is determined by the basic static load rating of the bearing; however, bearing service life, which is affected by permanent deformation, differs in accordance with the performance required of the bearing and operating conditions.

Therefore, a safety coefficient is designated, based on empirical data, so as to ensure safety in relation to basic static load rating.

$$f_s = \frac{C_0}{P_0} \quad (5-44)$$

where :

f_s : safety coefficient (ref. Table 5-10)

C_0 : basic static load rating N

P_0 : static equivalent load N

Table 5-10 Values of safety coefficient f_s

Operating condition		f_s (min.)	
		Ball bearing	Roller bearing
With bearing rotation	When high accuracy is required	2	3
	Normal operation	1	1.5
	When impact load is applied	1.5	3
Without bearing rotation (occasional oscillation)	Normal operation	0.5	1
	When impact load or uneven distribution load is applied	1	2

[Remark] For spherical thrust roller bearings, $f_s \geq 4$.

5-6 Allowable axial load for cylindrical roller bearings

Bearings whose inner and outer rings comprise either a rib or loose rib can accommodate a certain magnitude of axial load, as well as radial load. In such cases, axial load capacity is controlled by the condition of rollers, load capacity of rib or loose rib, lubrication, rotational speed etc.

For certain special uses, a design is available to accommodate very heavy axial loads. In general, axial loads allowable for cylindrical roller bearings can be calculated using the following equation, which are based on empirical data.

$$F_{ap} = 9.8 f_a \cdot f_b \cdot f_p \cdot d_m^2 \dots\dots\dots (5-45)$$

where :

- F_{ap} : maximum allowable axial load N
- f_a : coefficient determined from loading condition (Table 5-11)
- f_b : coefficient determined from bearing diameter series (Table 5-12)
- f_p : coefficient for rib surface pressure (Fig. 5-13)
- d_m : mean value of bore diameter d and outside diameter D mm

$$\left(\frac{d + D}{2} \right)$$

Table 5-11 Values of coefficient determined from loading condition f_a

Loading condition	f_a
Continuous loading	1
Intermittent loading	2
Instantaneous loading	3

Table 5-12 Values of coefficient determined from bearing diameter series f_b

Diameter series	f_b
9	0.6
0	0.7
2	0.8
3	1.0
4	1.2

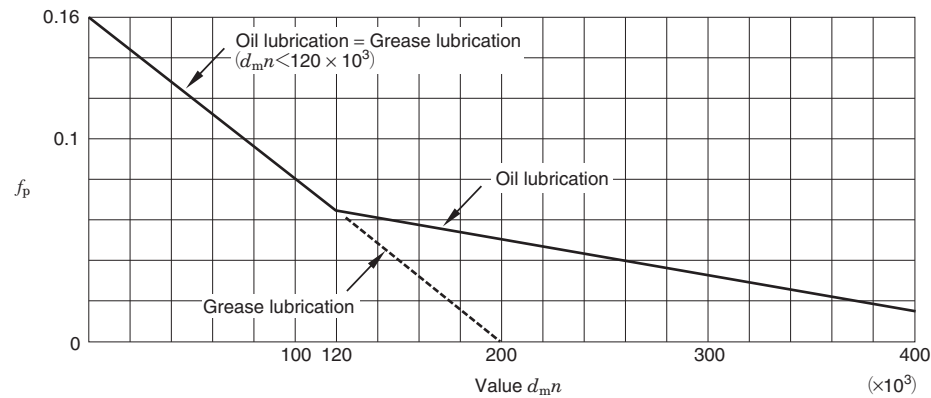
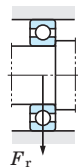
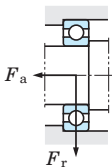
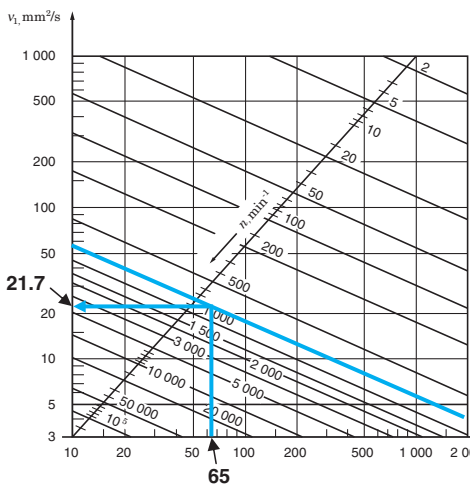
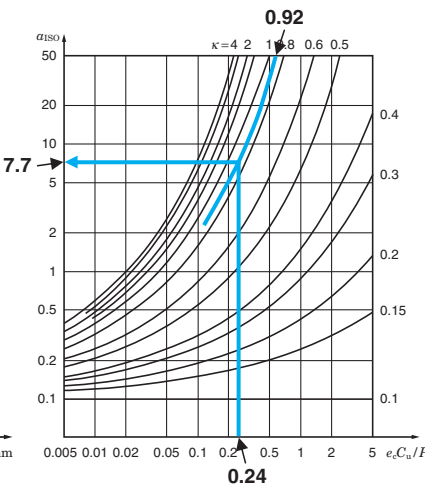

Fig. 5-13 Relationship between coefficient for rib surface pressure f_p and value $d_m n$ (n : rotational speed, min^{-1})

5-7 Applied calculation examples

[Example 1] Bearing service life (time) with 90 % reliability	[Example 2] Bearing service life (time) with 96 % reliability
<p>(Conditions)</p> <p>Deep groove ball bearing : 6308</p> <p>Radial load $F_r = 3\,500\text{ N}$</p> <p>Axial load not applied ($F_a = 0$)</p> <p>Rotational speed $n = 800\text{ min}^{-1}$</p> 	<p>(Conditions)</p> <p>Deep groove ball bearing : 6308</p> <p>Radial load $F_r = 3\,500\text{ N}$</p> <p>Axial load $F_a = 1\,000\text{ N}$</p> <p>Rotational speed $n = 800\text{ min}^{-1}$</p> 
<p>① Basic dynamic load rating (C_r) is obtained from the bearing specification table.</p> <p>$C_r = 50.9\text{ kN}$</p> <p>② Dynamic equivalent radial load (P_r) is calculated using equation (5-32).</p> <p>$P_r = F_r = 3\,500\text{ N}$</p> <p>③ Bearing service life (L_{10h}) is calculated using equation (5-2).</p> $L_{10h} = \frac{10^6}{60n} \left(\frac{C}{P}\right)^p$ $= \frac{10^6}{60 \times 800} \times \left(\frac{50.9 \times 10^3}{3\,500}\right)^3 \doteq \underline{64\,100\text{ h}}$	<p>① From the bearing specification table ;</p> <ul style="list-style-type: none"> Basic load rating (C_r, C_{0r}) f_0 factor is obtained. $C_r = 50.9\text{ kN}$ $C_{0r} = 24.0\text{ kN}$ $f_0 = 13.2$ Values X and Y are obtained by comparing value e, calculated from value $f_0 F_a / C_{0r}$ via proportional interpolation, with value $f_0 F_a / F_r$. $\frac{f_0 F_a}{C_{0r}} = \frac{13.2 \times 1\,000}{24.0 \times 10^3} = 0.550$ $e = 0.22 + (0.26 - 0.22) \times \frac{(0.550 - 0.345)}{(0.689 - 0.345)}$ $= 0.24$ $\frac{F_a}{F_r} = \frac{1\,000}{3\,500} = 0.29 > e$ <p>The result is,</p> $X = 0.56$ $Y = 1.99 - (1.99 - 1.71) \times \frac{(0.550 - 0.345)}{(0.689 - 0.345)}$ $= 1.82$ <p>② Dynamic equivalent load (P_r) is obtained using equation (5-32).</p> $P_r = XF_r + YF_a$ $= (0.56 \times 3\,500) + (1.82 \times 1\,000) = 3\,780\text{ N}$ <p>③ Service life with 90 % reliability (L_{10h}) is obtained using equation (5-2).</p> $L_{10h} = \frac{10^6}{60n} \left(\frac{C}{P}\right)^p$ $= \frac{10^6}{60 \times 800} \times \left(\frac{50.9 \times 10^3}{3\,780}\right)^3 \doteq \underline{50\,900\text{ h}}$

[Example 3] Calculation of the a_{ISO} factor with the conditions in Example 2	
<p>(Conditions)</p> <p>Oil lubrication</p> <p>(Oil that has been filtered by a fine filter)</p> <p>Operating temperature $70\text{ }^\circ\text{C}$</p> <p>96 % reliability</p>	
<p>④ Lubricating oil selection</p> <p>From the bearing specification table, the pitch diameter $D_{pw} = (40 + 90)/2 = 65$ is obtained.</p> <p>$d_{mn} = 65 \times 800 = 52\,000$. Therefore, select VG 68 from Table 12-8, p. A 129.</p> <p>⑤ Calculating the a_{ISO} factor</p> <p>The operating temperature is $70\text{ }^\circ\text{C}$, so according to Fig. 12-3, p. A 129, the viscosity when operating is $v = 20\text{ mm}^2/\text{s}$</p> <p>According to Fig. A, $v_1 = 21.7\text{ mm}^2/\text{s}$</p> $\kappa = v/v_1 = 20/21.7 = 0.92$ <p>The oil has been filtered by a fine filter, so Table 5-4 shows e_c is 0.5 to 0.6.</p> <p>To stringently estimate the value, $e_c = 0.5$.</p> $\frac{e_c \cdot C_u}{P} = \frac{0.5 \times 1\,850}{3\,780} = 0.24$ <p>Therefore, according to Fig. B</p> $a_{ISO} = 7.7$ <p>⑥ Service life with 96 % reliability (L_{nm}) is obtained using equation (5-8).</p> <p>According to Table 5-3, $a_1 = 0.55$.</p> $L_{4m} = a_1 a_{ISO} L_{10} = 0.55 \times 7.7 \times 50\,900 \doteq 216\,000\text{ h}$	
 <p style="text-align: center;">Fig. A</p>	 <p style="text-align: center;">Fig. B</p>

The a_{ISO} factor can also be calculated on our website.

[Example 4] Bearing service life (total revolution)

(Conditions)
 Tapered roller bearing
 Bearing A : 30207 JR
 Bearing B : 30209 JR
 Radial load $F_{rA} = 5\,200\text{ N}$
 $F_{rB} = 6\,800\text{ N}$
 Axial load $K_a = 1\,600\text{ N}$

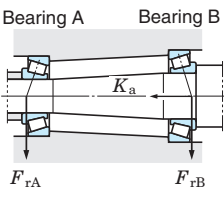

① From the bearing specification table, the following specifications are obtained.

	Basic dynamic load rating (C_r)	e	$X^{1)}$	$Y^{1)}$
Bearing A	68.8 kN	0.37	0.4	1.60
Bearing B	83.9 kN	0.40	0.4	1.48

[Note] 1) Those values are used, where $F_a/F_r > e$.
 Where $F_a/F_r \leq e$, $X = 1$, $Y = 0$.

② Axial load applied to shafts must be calculated, considering the fact that component force in the axial direction is generated when radial load is applied to tapered roller bearings. (ref. equation 5-33, Table 5-9)

$$\frac{F_{rA}}{2 Y_A} + K_a = \frac{5\,200}{2 \times 1.60} + 1\,600 = 3\,225\text{ N}$$

$$\frac{F_{rB}}{2 Y_B} = \frac{6\,800}{2 \times 1.48} = 2\,297\text{ N}$$

Consequently, axial load $\frac{F_{rA}}{2 Y_A} + K_a$ is applied to bearing B.

③ Dynamic equivalent load (P_r) is obtained from Table 5-9.

$$P_{rA} = F_{rA} = 5\,200\text{ N}$$

$$P_{rB} = X F_{rB} + Y_B \left(\frac{F_{rA}}{2 Y_A} + K_a \right)$$

$$= 0.4 \times 6\,800 + 1.48 \times 3\,225 = 7\,493\text{ N}$$

④ Each bearing service life (L_{10}) is calculated using equation (5-1).

$$L_{10A} = \left(\frac{C_{rA}}{P_{rA}} \right)^{10/3} = \left(\frac{68.8 \times 10^3}{5\,200} \right)^{10/3}$$

$$\doteq 5\,480 \times 10^6 \text{ revolutions}$$

$$L_{10B} = \left(\frac{C_{rB}}{P_{rB}} \right)^{10/3} = \left(\frac{83.9 \times 10^3}{7\,493} \right)^{10/3}$$

$$\doteq 3\,140 \times 10^6 \text{ revolutions}$$

[Example 5] Bearing size selection

(Conditions)
 Deep groove ball bearing :
 62 series
 Required service life :
 more than 10 000 h
 Radial load $F_r = 2\,000\text{ N}$
 Axial load $F_a = 300\text{ N}$
 Rotational speed $n = 1\,600\text{ min}^{-1}$

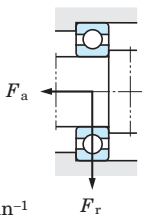

① The dynamic equivalent load (P_r) is hypothetically calculated.

The resultant value, $F_a/F_r = 300/2\,000 = 0.15$, is smaller than any other values of e in the bearing specification table.
 Hence, JTEKT can consider that $P_r = F_r = 2\,000\text{ N}$.

② The required basic dynamic load rating (C_r) is calculated according to equation (5-4).

$$C_r = P_r \left(L_{10h} \times \frac{60n}{10^6} \right)^{1/p}$$

$$= 2\,000 \times \left(10\,000 \times \frac{60 \times 1\,600}{10^6} \right)^{1/3}$$

$$= 19\,730\text{ N}$$

③ Among those covered by the bearing specification table, the bearing of the 62 series with C_r exceeding 19 730 N is 6205 R, with bore diameter for 25 mm.

④ The dynamic equivalent load obtained at step ① is confirmed by obtaining value e for 6205 R.

Where C_{0r} of 6205 R is 9.3 kN, and f_0 is 12.8

$$f_0 F_a / C_{0r} = 12.8 \times 300 / 9\,300 = 0.413$$

Then, value e can be calculated using proportional interpolation.

$$e = 0.22 + (0.26 - 0.22) \times \frac{(0.413 - 0.345)}{(0.689 - 0.345)}$$

$$= 0.23$$

As a result, it can be confirmed that $F_a/F_r = 0.15 < e$.
 Hence, $P_r = F_r$.

[Example 6] Bearing size selection

(Conditions)
 Deep groove ball bearing :
 63 series
 Required service life :
 more than 15 000 h
 Radial load $F_r = 4\,000\text{ N}$
 Axial load $F_a = 2\,400\text{ N}$
 Rotational speed $n = 1\,000\text{ min}^{-1}$

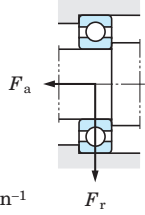

① The hypothetical dynamic equivalent load (P_r) is calculated :

Since $F_a/F_r = 2\,400/4\,000 = 0.6$ is much larger than the value e specified in the bearing specification table, it suggests that the axial load affects the dynamic equivalent load.

Hence, assuming that $X = 0.56$, $Y = 1.6$ (approximate mean value of Y), using equation (5-32),
 $P_r = X F_r + Y F_a = 0.56 \times 4\,000 + 1.6 \times 2\,400$
 $= 6\,080\text{ N}$

② Using equation (5-4), the required basic dynamic load rating (C_r) is :

$$C_r = P_r \left(L_{10h} \times \frac{60n}{10^6} \right)^{1/p}$$

$$= 6\,080 \times \left(15\,000 \times \frac{60 \times 1\,000}{10^6} \right)^{1/3}$$

$$= 58\,700\text{ N}$$

③ From the bearing specification table, a 6309 with a bore diameter of 45 mm is selected as a 63 series bearing with C_r exceeding 58 700 N.

④ The dynamic equivalent load and basic rating life are confirmed, by calculating the value e for a 6309.

Values obtained using the proportional interpolation are :
 where $f_0 F_a / C_{0r} = 13.3 \times 2\,400 / 29\,500 = 1.082$
 $e = 0.283$, $Y = 1.54$.
 Thus, $F_a/F_r = 0.6 > e$.
 Using the resultant values, the dynamic equivalent load and basic rating life can be calculated as follows :

$$P_r = X F_r + Y F_a$$

$$= 0.56 \times 4\,000 + 1.54 \times 2\,400 = 5\,940\text{ N}$$

$$L_{10h} = \frac{10^6}{60n} \left(\frac{C_r}{P_r} \right)^p$$

$$= \frac{10^6}{60 \times 1\,000} \times \left(\frac{61.1 \times 10^3}{5\,940} \right)^3 \doteq 18\,100\text{ h}$$

⑤ The basic rating life of the 6308, using the same steps, is :
 $L_{10h} \doteq 11\,500\text{ h}$, which does not satisfy the service life requirement.

[Example 7] Calculation of allowable axial load for cylindrical roller bearings

(Conditions)
 Single-row cylindrical roller bearing : NUP 310
 Rotational speed $n = 1\,500\text{ min}^{-1}$
 Oil lubrication
 Axial load is intermittently applied.

① Using the bearing specification table, the value d_m for the NUP 310 can be calculated as follows :

$$d_m = \frac{d + D}{2} = \frac{50 + 110}{2} = 80\text{ mm}$$

② Each coefficient used in equation (5-45).
 From values listed in Table 5-11, coefficient f_a related to intermittent load is : $f_a = 2$

From values listed in Table 5-12, coefficient f_b related to diameter series 3 is : $f_b = 1.0$

According to Fig. 5-13, coefficient f_p for allowable rib surface pressure, related to $d_m n = 80 \times 1\,500 = 12 \times 10^4$, is : $f_p = 0.062$

③ Using equation (5-45), the allowable axial load F_{ap} is :

$$F_{ap} = 9.8 f_a \cdot f_b \cdot f_p \cdot d_m^2$$

$$= 9.8 \times 2 \times 1.0 \times 0.062 \times 80^2$$

$$\doteq 7\,780\text{ N}$$

[Example 8] Calculation of service life of spur gear shaft bearings

(Conditions)

Tapered roller bearing

Bearing A : 32309 JR

Bearing B : 32310 JR

Gear type : spur gear (normally machined)

Gear pressure angle $\alpha_1 = \alpha_2 = 20^\circ$

Gear pitch circle diameter $D_{p1} = 360$ mm

$D_{p2} = 180$ mm

Transmission power $W = 150$ kW

Rotational speed $n = 1\,000$ min⁻¹

Operating condition: accompanied by impact

Installation locations

$a_1 = 95$ mm, $a_2 = 265$ mm,

$b_1 = 245$ mm, $b_2 = 115$ mm,

$c = 360$ mm

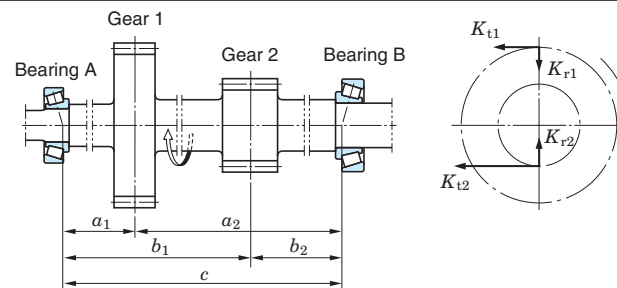

- ① Using equations (5-14) and (5-15), theoretical loads applied to gears (tangential load, K_t ; radial load, K_r) are calculated.

[Gear 1]

$$K_{t1} = \frac{19.1 \times 10^6 W}{D_p n} = \frac{19.1 \times 10^6 \times 150}{360 \times 1\,000} = 7\,958 \text{ N}$$

$$K_{r1} = K_{t1} \tan \alpha_1 = 2\,896 \text{ N}$$

[Gear 2]

$$K_{t2} = \frac{19.1 \times 10^6 \times 150}{180 \times 1\,000} = 15\,917 \text{ N}$$

$$K_{r2} = K_{t2} \tan \alpha_2 = 5\,793 \text{ N}$$

- ② The radial load applied to the bearing is calculated, where the load coefficient is determined as $f_w = 1.5$ from Table 5-6, and the gear coefficient as $f_g = 1.2$ from Table 5-8.

[Bearing A]

- Load consisting of K_{t1} and K_{t2} is :

$$K_{tA} = f_w f_g \left(\frac{a_2}{c} K_{t1} + \frac{b_2}{c} K_{t2} \right) = 1.5 \times 1.2 \times \left(\frac{265}{360} \times 7\,958 + \frac{115}{360} \times 15\,917 \right) = 19\,697 \text{ N}$$

- Load consisting of K_{r1} and K_{r2} is :

$$K_{rA} = f_w f_g \left(\frac{a_2}{c} K_{r1} - \frac{b_2}{c} K_{r2} \right) = 1.5 \times 1.2 \times \left(\frac{265}{360} \times 2\,896 - \frac{115}{360} \times 5\,793 \right) = 506 \text{ N}$$

- Combining the loads of K_{tA} and K_{rA} , the radial load (F_{rA}) applied to bearing A can be calculated as follows :

$$F_{rA} = \sqrt{K_{tA}^2 + K_{rA}^2} = \sqrt{19\,697^2 + 506^2} = 19\,703 \text{ N}$$

[Bearing B]

- Load consisting of K_{t1} and K_{t2} is :

$$K_{tB} = f_w f_g \left(\frac{a_1}{c} K_{t1} + \frac{b_1}{c} K_{t2} \right) = 1.5 \times 1.2 \times \left(\frac{95}{360} \times 7\,958 + \frac{245}{360} \times 15\,917 \right) = 23\,278 \text{ N}$$

- Load consisting of K_{r1} and K_{r2} is :

$$K_{rB} = f_w f_g \left(\frac{a_1}{c} K_{r1} - \frac{b_1}{c} K_{r2} \right) = 1.5 \times 1.2 \times \left(\frac{95}{360} \times 2\,896 - \frac{245}{360} \times 5\,793 \right) = -5\,721 \text{ N}$$

- The radial load (F_{rB}) applied to bearing B can be calculated using the same steps as with bearing A.

$$F_{rB} = \sqrt{K_{tB}^2 + K_{rB}^2} = \sqrt{23\,278^2 + (-5\,721)^2} = 23\,971 \text{ N}$$

- ③ The following specifications can be obtained from the bearing specification table.

	Basic dynamic load rating (C_r)	e	$X^{(1)}$	$Y^{(1)}$
Bearing A	183 kN	0.35	0.4	1.74
Bearing B	221 kN			

[Note] 1) Those values are used, where $F_a/F_r > e$. Where $F_a/F_r \leq e$, $X = 1$, $Y = 0$.

- ④ When an axial load is not applied externally, if the radial load is applied to the tapered roller bearing, an axial component force is generated.

Considering this fact, the axial load applied from the shaft and peripheral parts is to be calculated :

(Equation 5-33, Table 5-9)

$$\frac{F_{rB}}{2 Y_B} = \frac{23\,971}{2 \times 1.74} > \frac{F_{rA}}{2 Y_A} = \frac{19\,703}{2 \times 1.74}$$

According to the result, it is clear that the axial component force ($F_{rB}/2Y_B$) applied to bearing B is also applied to bearing A as an axial load applied from the shaft and peripheral parts.

- ⑤ Using the values listed in Table 5-9, the dynamic equivalent load is calculated, where $K_a = 0$:

$$P_{rA} = X F_{rA} + Y_A \frac{F_{rB}}{2 Y_B} = 0.4 \times 19\,703 + 1.74 \times \frac{23\,971}{2 \times 1.74} = 19\,867 \text{ N}$$

$$P_{rB} = F_{rB} = 23\,971 \text{ N}$$

- ⑥ Using equation (5-2), the basic rating life of each bearing is calculated :

[Bearing A]

$$L_{10hA} = \frac{10^6}{60n} \left(\frac{C_{rA}}{P_A} \right)^p = \frac{10^6}{60 \times 1\,000} \times \left(\frac{183 \times 10^3}{19\,867} \right)^{10/3} \doteq 27\,300 \text{ h}$$

[Bearing B]

$$L_{10hB} = \frac{10^6}{60n} \left(\frac{C_{rB}}{P_B} \right)^p = \frac{10^6}{60 \times 1\,000} \times \left(\frac{221 \times 10^3}{23\,971} \right)^{10/3} \doteq 27\,400 \text{ h}$$

Reference

Using equation (5-11), the system service life (L_{10hs}) using a pair of bearings is :

$$L_{10hs} = \frac{1}{\left(\frac{1}{L_{10hA}^e} + \frac{1}{L_{10hB}^e} \right)^{1/e}} = \frac{1}{\left(\frac{1}{27\,300^{9/8}} + \frac{1}{27\,400^{9/8}} \right)^{8/9}} \doteq 14\,800 \text{ h}$$

6-3 Bearing number

A bearing number is composed of a basic number and a supplementary code, denoting bearing specifications including bearing type, boundary dimensions, running accuracy, and internal clearance.

Bearing numbers of standard bearings corresponding to JIS B 1512 "rolling bearing boundary dimensions" are prescribed in JIS B 1513.

As well as these bearing numbers, JTEKT uses supplementary codes other than those provided by JIS.

Among basic numbers, bearing series codes are listed in Table 6-1, and the composition of bearing numbers is described in Table 6-2, showing the order of arrangement of the parts.

[Examples of bearing numbers]

(Ex. 1)

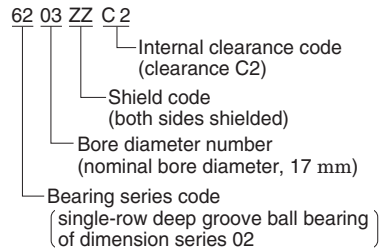

(Ex. 2)

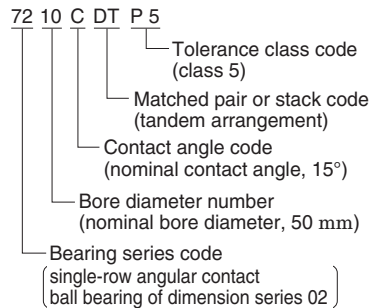

(Ex. 3)

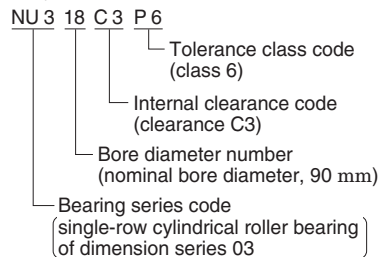

(Ex. 4)

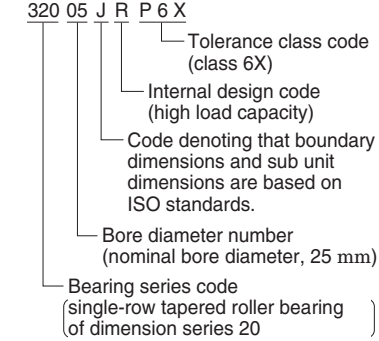

(Ex. 5)

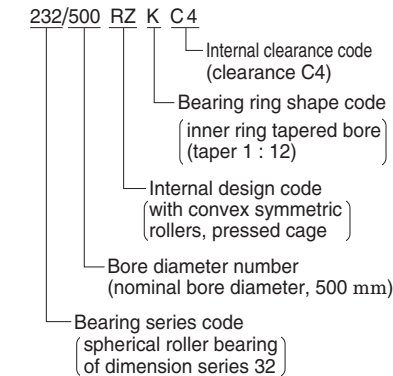

(Ex. 6)

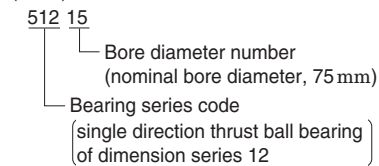

Table 6-1 Bearing series code

Bearing type	Bearing series code	Type code	Dimension series code	
			Width series ¹⁾	Diameter series
Single-row deep groove ball bearing	67	6	(1)	7
	68	6	(1)	8
	69	6	(1)	9
	160 ²⁾	6	(0)	0
	60	6	(1)	0
	62	6	(0)	2
	63	6	(0)	3
	64	6	(0)	4
Double-row deep groove ball bearing (with filling slot)	42	4	(2)	2
	43	4	(2)	3
Single-row angular contact ball bearing	79	7	(1)	9
	70	7	(1)	0
	72	7	(0)	2
	73	7	(0)	3
Double-row angular contact ball bearing (with filling slot)	32	(0)	3	2
	33	(0)	3	3
Double-row angular contact ball bearing	52	5	(3)	2
	53	5	(3)	3
Self-aligning ball bearing	12	1	(0)	2
	22	2	(2)	2
	13	1	(0)	3
	23	2	(2)	3
	112 ²⁾	1	(0) ³⁾	2
Single-row cylindrical roller bearing	113 ²⁾	1	(0) ³⁾	3
	NU 10	NU ⁴⁾	1	0
	NU 2	NU ⁴⁾	(0)	2
	NU 22	NU ⁴⁾	2	2
	NU 32	NU ⁴⁾	3	2
	NU 3	NU ⁴⁾	(0)	3
Double-row cylindrical roller bearing	NU 23	NU ⁴⁾	2	3
	NU 4	NU ⁴⁾	(0)	4
	NNU 49	NNU	4	9
	NN 30	NN	3	0
Single-row needle roller bearing	NA 48	NA	4	8
	NA 49	NA	4	9
	NA 59	NA	5	9
Double-row needle roller bearing	NA 69	NA	6	9

Bearing type	Bearing series code	Type code	Dimension series code	
			Width series	Diameter series
Tapered roller bearing	329	3	2	9
	320	3	2	0
	330	3	3	0
	331	3	3	1
	302	3	0	2
	322	3	2	2
	332	3	3	2
	303	3	0	3
	313	3	1	3
	323	3	2	3
Spherical roller bearing	239	2	3	9
	230	2	3	0
	240	2	4	0
	231	2	3	1
	241	2	4	1
	222	2	2	2
	232	2	3	2
	213 ²⁾	2	0	3
223	2	2	3	
Single direction thrust ball bearing	511	5	1	1
	512	5	1	2
	513	5	1	3
Single direction thrust ball bearing with spherical back face	514	5	1	4
	532	5	3	2
	533	5	3	3
Double direction thrust ball bearing	534	5	3	4
	522	5	2	2
Double direction thrust ball bearing with spherical back faces	523	5	2	3
	524	5	2	4
Spherical thrust roller bearing	542	5	4	2
	543	5	4	3
	544	5	4	4
Spherical thrust roller bearing	292	2	9	2
	293	2	9	3
	294	2	9	4

[Notes]

1) Width series codes in parentheses are omitted in bearing series codes.

2) These are bearing series codes customarily used.

3) Nominal outer ring width series (inner rings only are wide).

4) Besides NU type, NJ, NUP, N, NF, and NH are provided.

Table 6-2 Bearing number configuration

Order of arrangement	Basic number			Supplementary			code						
	Bearing series code	Bore diameter No.	Contact angle code	Internal design code, cage guide code	Shield/seal code	Ring shape code, lubrication hole/groove code	Material code, special treatment code	Matched pair or stack code	Internal clearance code, preload code	Spacer code	Cage material/ shape code	Tolerance code	Grease code

(Codes and descriptions)

Bearing series code

- 68 Deep groove ball bearing
- 69
- 60
- ...

(For standard bearing code, refer to Table 6-1)

Bore diameter No.

- /0.6 0.6 mm (Bore diameter)
- 1 1
- /1.5 1.5
- ...
- 9 9
- 00 10
- 01 12
- 02 15
- 03 17

- 04 20
 - /22 22
 - 05 25
 - ...
 - 96 480
- Bore diameters (mm) of bearing in the bore diameter range 04 to 96 can be obtained by multiplying their bore diameter number by five.

- /500 500
- /2500 2500

Contact angle code

- A (omitted) 30°
 - AC 25°
 - B 40°
 - C 15°
 - CA 20°
 - E 35°
 - B (omitted) Less than 17°
 - C 20°
 - D 28° 30'
 - DJ 28° 48' 39"
- Angular contact ball bearing
- Tapered roller bearing

Internal design code

- R High load capacity (Deep groove ball bearing, cylindrical roller bearing, tapered roller bearing)

- G Equal stand-out is provided on both sides of the ring of angular contact ball bearing (In general, C2 clearance is used)
 - GST Angular contact ball bearing described above with standard internal clearance provided
 - J Tapered roller bearing, whose outer ring width, contact angle and outer ring small inside diameter conform to ISO standards
 - R With convex asymmetric rollers and machined cage
 - RZ With convex symmetric rollers and pressed cage
 - RHA With convex symmetric rollers and one-piece machined cage
- Spherical roller bearings
-
- V Full complement type ball or roller bearing (with no cage)

Shield/seal code

- | | | |
|----------|------------|------------------------------|
| one side | both sides | |
| Z | ZZ | Fixed shield |
| ZX | ZZX | Removable shield |
| ZU | 2ZU | Non-contact seal |
| RU | 2RU | |
| RS | 2RS | Contact seal |
| RK | 2RK | |
| U | UU | |
| RD | 2RD | Extremely light contact seal |

Ring shape code, lubrication hole/groove code

- K Inner ring tapered bore provided (1 : 12)
- K30 Inner ring tapered bore provided (1 : 30)
- N Snap ring groove on outer ring outside surface provided
- NR Snap ring groove and locating snap ring on outer ring outside surface provided

(Codes and descriptions)

- NY Creep prevention synthetic resin ring on outer ring outside surface provided
- SG Spiral groove on inner ring bore surface provided
- W Lubrication hole and lubrication groove on cylindrical roller bearing outer ring outside surface provided
- W33 Lubrication hole and lubrication groove on spherical roller bearing outer ring outside surface provided

Material code, special treatment code

- Code not given High carbon chrome bearing steel
- E Case carburizing steel
- F Case carburizing steel
- H Case carburizing steel
- Y Case carburizing steel
- ST Stainless steel
- SH Special heat treatment
- S0 Up to 150 °C
- S1 Up to 200 °C (Dimension stabilizing treatment)
- S2 Up to 250 °C

Matched pair or stack code, cage guide code

- DB Back-to-back arrangement (Angular contact ball bearing)
- DF Face-to-face arrangement (Angular contact ball bearing)
- DT Tandem arrangement (Angular contact ball bearing)
- PA With outer ring guide cage (Ball bearing)
- Q3 With roller guide cage (Roller bearing)

Internal clearance code, preload code

- C1 Smaller than C2
- C2 Smaller than standard clearance
- CN Standard clearance (Radial internal clearance for radial bearing)
- C3 Greater than standard clearance
- C4 Greater than C3
- C5 Greater than C4
- M1 to M6 (Radial internal clearance for extra-small/miniature ball bearing)
- CD2 Smaller than standard clearance (Radial internal clearance for double-row angular contact ball bearing)
- CDN Standard clearance
- CD3 Greater than standard clearance

- CM Radial internal clearance for electric motor bearing (Deep groove ball bearing)
- CT Cylindrical roller bearing (Cylindrical roller bearing)

- NA Non-interchangeable cylindrical roller bearing radial internal clearance (C1NA to C5NA)

- S Slight preload
- L Light preload (Preload for angular contact ball bearing)
- M Medium preload
- H Heavy preload

Spacer code (Spacer width (mm) is affixed to the end of each code.)

- + Inner and outer ring spacers provided (Deep groove ball bearing)
- / Inner and outer ring spacers provided (Angular contact ball bearing)
- /P Outer ring spacer provided
- /S Inner ring spacer provided
- +DP Inner and outer ring spacers provided (Cylindrical roller bearing, spherical roller bearing)
- +IDP Inner ring spacer provided
- +ODP Outer ring spacer provided

Cage material/type code

- // Steel sheet (Pressed cage)
- YS Stainless steel sheet
- FT Phenol resin
- FY High-tensile brass casting (Machined cage)
- FW High-tensile brass casting (separable type)
- MG Polyamide (Molded cage)
- FG Polyamide
- FP Carbon steel (Pin type cage)

Tolerance code (JIS)

- Omitted Class 0
- P6 Class 6
- P6X Class 6X
- P5 Class 5
- P4 Class 4
- P2 Class 2

Grease code

- A2 Alvania 2
- AC Andok C
- B5 Beacon 325
- SR Multemp SRL

7. Bearing tolerances

7-1 Tolerances and tolerance classes for bearings

Bearing tolerances and permissible values for the boundary dimensions and running accuracy of bearings are specified.

These tolerances are prescribed in JIS B 1514-1, JIS B 1514-2, and JIS B 1514-3 (roller bearings - bearing tolerances part 1: radial bearings, part 2: thrust bearings, and part 3: permissible values for chamfer dimensions). (These JIS standards are based on ISO standards.)

Bearing tolerances are standardized by classifying bearings into the following six classes (accuracy in tolerances becomes higher in the order described): 0, 6X, 6, 5, 4 and 2.

Class 0 bearings offer adequate performance for general applications; and, bearings of class 5 or higher are required for demanding applications and operating conditions including those described in Table 7-1.

These tolerances follow ISO standards, but some countries use different names for them. Tolerances for each bearing class, and organizations concerning bearings are listed in Table 7-2.

- Boundary dimension accuracy (items on shaft and housing mounting dimensions)
 - Tolerances for bore diameter, outside diameter, ring width, assembled bearing width
 - Tolerances for set bore diameter and set outside diameter of rollers
 - Tolerance limits for chamfer dimensions
 - Permissible values for width variation
 - Tolerance and permissible values for tapered bore
- Running accuracy (items on runout of rotating elements)
 - Permissible values for radial and axial runout of inner and outer rings
 - Permissible values for perpendicularity of inner ring face
 - Permissible values for perpendicularity of outer ring outside surface
 - Permissible values for thrust bearing raceway thickness

Accuracies for dimensions and running of each bearing type are listed in Tables 7-3 through 7-10; and, tolerances for tapered bore and limit values for chamfer dimensions of radial bearings are in Tables 7-11 and 7-12.

Table 7-1 High precision bearing applications

Required performance	Applications	Tolerance class
High accuracy in runout is required for rolling elements.	Acoustic / visual equipment spindles (VTR, tape recorders)	P 5, P 4
	Radar / parabola antenna slewing shafts	P 4
	Machine tool spindles	P 5, P 4, P 2, ABEC 9
	Computers, magnetic disc spindles	P 5, P 4, P 2, ABEC 9
	Aluminum foil roll necks	P 5
High speed rotation	Multi-stage mill backing bearings	P 4
	Dental spindles	P 2, ABMA 5P, ABMA 7P
	Superchargers	P 5, P 4
	Jet engine spindles and accessories	P 5, P 4
	Centrifugal separators	P 5, P 4
	LNG pumps	P 5
	Turbo molecular pump spindles and touch-down	P 5, P 4
Low friction or low friction variation is required.	Machine tool spindles	P 5, P 4, P 2, ABEC 9
	Tension reels	P 5, P 4
	Control equipment (synchronous motors, servomotors, gyro gimbals)	P 4, ABMA 7P
	Measuring instruments	P 5
	Machine tool spindles	P 5, P 4, P 2, ABEC 9

Table 7-2 Bearing type and tolerance class

Bearing type		Applied standards	Applied tolerance class						Tolerance table	
Deep groove ball bearing		JIS B 1514-1	Class 0	–	Class 6	Class 5	Class 4	Class 2	Table 7-3	
Angular contact ball bearing			Class 0	–	Class 6	Class 5	Class 4	Class 2		
Self-aligning ball bearing			Class 0	–	–	–	–	–		
Cylindrical roller bearing			Class 0	–	Class 6	Class 5	Class 4	Class 2		
Needle roller bearing (machined ring type)		JIS B 1536-1	Class 0	–	–	–	–	–		
Tapered roller bearing	Metric series (single-row)	JIS B 1514-1	Class 0	Class 6X	(Class 6)	Class 5	Class 4	Class 2	Table 7-5	
	Metric series (double or four-row)	BAS 1002	Class 0	–	–	–	–	–	Table 7-6	
	Inch series	ANSI/ABMA	Class 4	–	Class 2	Class 3	Class 0	Class 00	Table 7-7	
	Metric series (J-series)		Class PK	–	Class PN	Class PC	Class PB	–	Table 7-8	
Spherical roller bearing		JIS B 1514-1	Class 0	–	–	–	–	–	Table 7-3	
Thrust ball bearing		JIS B 1514-2	Class 0	–	Class 6	Class 5	Class 4	–	Table 7-9	
Spherical thrust roller bearing			Class 0	–	–	–	–	–	Table 7-10	
Precision ball screw support bearing		JTEKT standards	–	–	–	Class P5Z	Class P4Z	–	–	
Double direction angular contact thrust ball bearing			–	–	–	Equivalent to class 5	Equivalent to class 4	–	–	
(Reference) Class comparison	ISO	Radial bearing	ISO 492	Normal Class	Class 6X	Class 6	Class 5	Class 4	Class 2	–
		Thrust bearing	ISO 199	Normal Class	–	Class 6	Class 5	Class 4	–	–
	DIN BS NF	Radial and thrust bearings	DIN 620 BS 6107 NF E 22-335	Normal Class	Class 6X	Class 6	Class 5	Class 4	Class 2	–
	ANSI ABMA	Radial bearing	ABMA std. 20	ABEC 1 RBEC 1	–	ABEC 3 RBEC 3	ABEC 5 RBEC 5	ABEC 7 –	ABEC 9 –	–
		Instrument ball bearing	ABMA std. 12	–	–	Class 3P	Class 5P Class 5T	Class 7P Class 7T	Class 9P	Table 7-4
		Tapered roller bearing	ABMA std. 19	Class 4 Class K	–	Class 2 Class N	Class 3 Class C	Class 0 Class B	Class 00 Class A	Table 7-7

(Reference) Standards and organizations concerned with bearings

- JIS : Japanese Industrial Standard
- BAS : The Japan Bearing Industrial Association Standard
- ISO : International Organization for Standardization
- ANSI : American National Standards Institute, Inc.
- ABMA : American Bearing Manufacturers Association
- DIN : Deutsches Institut für Normung
- BS : British Standards Institution
- NF : Association Francaise de Normalisation

7. Bearing tolerances

Table 7-3 (1) Radial bearing tolerances (tapered roller bearings excluded)
= JIS B 1514-1 =

(1) Inner ring (bore diameter)

Unit : μm

Nominal bore diameter d mm		Single plane mean bore diameter deviation Δ_{dmp}												Single bore diameter deviation $\Delta_{ds}^{(1)}$				Single plane bore diameter variation V_{dsp}											Mean bore diameter variation V_{dmp}					Nominal bore diameter d mm		
														Diameter series 7, 8, 9		Diameter series 0, 1				Diameter series 2, 3, 4				Dia. series												
		class 0		class 6		class 5		class 4		class 2		class 4		class 2		class 0		class 6		class 5		class 4		class 2	class 0		class 6		class 5		class 4		class 2			
		upper	lower	upper	lower	upper	lower	upper	lower	upper	lower	upper	lower	upper	lower	upper	lower	upper	lower	upper	lower	upper	lower	upper	lower	upper	lower	upper	lower	upper	lower	upper	lower			over
–	0.6	0	– 8	0	– 7	0	– 5	0	– 4	0	– 2.5	0	– 4	0	– 2.5	10	9	5	4													–	0.6			
0.6	2.5	0	– 8	0	– 7	0	– 5	0	– 4	0	– 2.5	0	– 4	0	– 2.5	10	9	5	4												0.6	2.5				
2.5	10	0	– 8	0	– 7	0	– 5	0	– 4	0	– 2.5	0	– 4	0	– 2.5	10	9	5	4												2.5	10				
10	18	0	– 8	0	– 7	0	– 5	0	– 4	0	– 2.5	0	– 4	0	– 2.5	10	9	5	4												10	18				
18	30	0	– 10	0	– 8	0	– 6	0	– 5	0	– 2.5	0	– 5	0	– 2.5	13	10	6	5												18	30				
30	50	0	– 12	0	– 10	0	– 8	0	– 6	0	– 2.5	0	– 6	0	– 2.5	15	13	8	6												30	50				
50	80	0	– 15	0	– 12	0	– 9	0	– 7	0	– 4	0	– 7	0	– 4	19	15	9	7												50	80				
80	120	0	– 20	0	– 15	0	– 10	0	– 8	0	– 5	0	– 8	0	– 5	25	19	10	8												80	120				
120	150	0	– 25	0	– 18	0	– 13	0	– 10	0	– 7	0	– 10	0	– 7	31	23	13	10												120	150				
150	180	0	– 25	0	– 18	0	– 13	0	– 10	0	– 7	0	– 10	0	– 7	31	23	13	10												150	180				
180	250	0	– 30	0	– 22	0	– 15	0	– 12	0	– 8	0	– 12	0	– 8	38	28	15	12												180	250				
250	315	0	– 35	0	– 25	0	– 18	0	– 15	–	–	0	– 15	–	–	44	31	18	15												250	315				
315	400	0	– 40	0	– 30	0	– 23	0	– 18	–	–	0	– 18	–	–	50	38	23	18												315	400				
400	500	0	– 45	0	– 35	0	– 28	0	– 23	–	–	0	– 23	–	–	56	44	28	23												400	500				
500	630	0	– 50	0	– 40	0	– 35	–	–	–	–	–	–	–	–	63	50	35	–												500	630				
630	800	0	– 75	0	– 50	0	– 45	–	–	–	–	–	–	–	–	94	63	45	–												630	800				
800	1 000	0	– 100	0	– 60	0	– 60	–	–	–	–	–	–	–	–	125	75	60	–												800	1 000				
1 000	1 250	0	– 125	0	– 75	0	– 75	–	–	–	–	–	–	–	–	156	94	75	–												1 000	1 250				
1 250	1 600	0	– 160	–	–	–	–	–	–	–	–	–	–	–	–	200	–	–	–												1 250	1 600				
1 600	2 000	0	– 200	–	–	–	–	–	–	–	–	–	–	–	–	250	–	–	–												1 600	2 000				

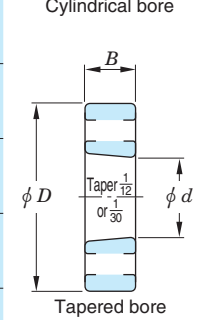
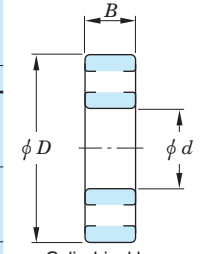

(2) Inner ring (running accuracy and width)

Unit : μm

Nominal bore diameter d mm		Radial runout of assembled bearing inner ring K_{ia}										Single inner ring width deviation				Single inner ring width deviation $\Delta_{Bs}^{(3)}$						Inner ring width variation V_{Bs}					Nominal bore diameter d mm										
		class 0		class 6		class 5		class 4		class 2		class 5		class 4		class 2		class 0 ⁽⁴⁾		class 6 ⁽⁴⁾		class 5 ⁽⁴⁾		classes 4, 2		class 0			class 6		class 5		class 4		class 2		
		upper	lower	upper	lower	upper	lower	upper	lower	upper	lower	upper	lower	upper	lower	upper	lower	upper	lower	upper	lower	upper	lower	upper	lower	upper			lower	upper	lower	upper	lower	upper	lower	over	up to
–	0.6	10	5	4	2.5	1.5	7	3	1.5	7	3	1.5	0	– 40	0	– 40	0	– 40	–	–	0	– 250	0	– 250	12	12	5	2.5	1.5	–	–	0.6					
0.6	2.5	10	5	4	2.5	1.5	7	3	1.5	7	3	1.5	0	– 40	0	– 40	0	– 40	–	–	0	– 250	0	– 250	12	12	5	2.5	1.5	0.6	2.5						
2.5	10	10	6	4	2.5	1.5	7	3	1.5	7	3	1.5	0	– 120	0	– 120	0	– 40	0	– 250	0	– 250	0	– 250	15	15	5	2.5	1.5	2.5	10						
10	18	10	7	4	2.5	1.5	7	3	1.5	7	3	1.5	0	– 120	0	– 120	0	– 80	0	– 250	0	– 250	0	– 250	20	20	5	2.5	1.5	10	18						
18	30	13	8	4	3	2.5	8	4	1.5	8	4	2.5	0	– 120	0	– 120	0	– 120	0	– 250	0	– 250	0	– 250	20	20	5	2.5	1.5	18	30						
30	50	15	10	5	4	2.5	8	4	1.5	8	4	2.5	0	– 120	0	– 120	0	– 120	0	– 250	0	– 250	0	– 250	20	20	5	3	1.5	30	50						
50	80	20	10	5	4	2.5	8	5	1.5	8	5	2.5	0	– 150	0	– 150	0	– 150	0	– 380	0	– 380	0	– 250	25	25	6	4	1.5	50	80						
80	120	25	13	6	5	2.5	9	5	2.5	9	5	2.5	0	– 200	0	– 200	0	– 200	0	– 380	0	– 380	0	– 380	25	25	7	4	2.5	80	120						
120	150	30	18	8	6	2.5	10	6	2.5	10	7	2.5	0	– 250	0	– 250	0	– 250	0	– 500	0	– 500	0	– 380	30	30	8	5	2.5	120	150						
150	180	30	18	8	6	5	10	6	4	10	7	5	0	– 250	0	– 250	0	– 250	0	– 500	0	– 500	0	– 380	30	30	8	5	4	150	180						
180	250	40	20	10	8	5	11	7	5	13	8	5	0	– 300	0	– 300	0	– 300	0	– 500	0	– 500	0	– 500	30	30	10	6	5	180	250						
250	315	50	25	13	10	–	13	8	–	15	9	–	0	– 350	0	– 350	0	– 350	0	– 500	0	– 500	–	–	35	35	13	8	–	250	315						
315	400	60	30	15	13	–	15	9	–	20	12	–	0	– 400	0	– 400	0	– 400	0	– 630	0	– 630	0	– 630	–	–	40	40	15	9	–	315	400				
400	500	65	35	20	15	–	18	11	–	25	15	–	0	– 450	0	– 450	0	– 450	–	–	–	–	–	–	–	–	50	45	18	11	–	400	500				
500	630	70	40	25	–	–	25	–	–	30	–	–	0	– 500	0	– 500	0	– 500	–	–	–	–	–	–	–	–	60	50	20	–	–	500	630				
630	800	80	50	30	–	–	30	–	–	35	–	–	0	– 750	0	– 750	0	– 750	–	–	–	–	–	–	–	–	70	60	23	–	–	630	800				
800	1 000	90	60	40	–	–	40	–	–	45	–	–	0	– 1 000	0	– 1 000	0	– 1 000	–	–	–	–	–	–	–	–	80	60	35	–	–	800	1 000				
1 000	1 250	100	70	50	–	–	50	–	–	60	–	–	0	– 1 250	0	– 1 250	0	– 1 250	–	–	–	–	–	–	–	–	100	60	45	–	–	1 000	1 250				
1 250	1 600	120	–	–	–	–	–	–	–	–	–	–	0	– 1 600	–	–	–	–	–	–	–	–	–	–	–	–	120	–	–	–	–	1 250	1 600				
1 600	2 000	140	–	–	–	–	–	–	–	–	–	–	0	– 2 000	–	–	–	–	–	–	–	–	–	–	–	–	140	–	–	–	–	1 600	2 000				

S_d : perpendicularity of inner ring face with respect to the bore S_{ia} : axial runout of assembled bearing inner ring

[Notes] 1) These shall be applied to bearings of diameter series 0, 1, 2, 3 and 4.

2) These shall be applied to deep groove ball bearings and angular contact ball bearings.

3) These shall be applied to individual bearing rings manufactured for matched pair or stack bearings.

4) Also applicable to the inner ring with tapered bore of $d \geq 50$ mm.

[Remark] Values in Italics are prescribed in JTEKT standards.

7. Bearing tolerances

(Refer.) Table 7-4 Tolerances for measuring instrument ball bearings (inch series)
= ANSI/ABMA standards = (reference)

(1) Inner ring and outer ring width

Unit : μm

Nominal bore dia. d mm	Single plane mean bore diameter deviation Δd_{mp}				Single bore diameter deviation Δd_s				Single plane bore diameter variation V_{dsp}				Mean bore diameter variation V_{dmp}			Radial runout of assembled bearing inner ring K_{ia}			Axial runout of assembled bearing inner ring S_{ia}			Perpendicularity of inner ring face with respect to the bore S_d			Single inner or outer ring width deviation $\Delta B_s, \Delta C_s$		Inner or outer ring width variation V_{Bs}, V_{Cs}		
	classes 5P, 7P		class 9P		classes 5P, 7P		class 9P		classes 5P, 7P		class 9P		classes 5P, 7P		class 9P	class 5P		class 7P	class 9P	class 5P		class 7P	class 9P	classes 5P, 7P, 9P		class 5P	class 7P	class 9P	
	upper	lower	upper	lower	upper	lower	upper	lower	upper	lower	upper	lower	upper	lower	upper	lower	upper	lower	upper	lower	upper	lower	upper	lower	upper	lower	upper	lower	upper
over	up to																												
-	18	0	-5.1	0	-2.5	0	-5.1	0	-2.5	2.5	1.3	2.5	1.3	3.8	2.5	1.3	7.6	2.5	1.3	7.6	2.5	1.3	0	-25.4	5.1	2.5	1.3		
10	18	0	-5.1	0	-2.5	0	-5.1	0	-2.5	2.5	1.3	2.5	1.3	3.8	2.5	1.3	7.6	2.5	1.3	7.6	2.5	1.3	0	-25.4	5.1	2.5	1.3		
18	30	0	-5.1	0	-2.5	0	-5.1	0	-2.5	2.5	1.3	2.5	1.3	3.8	3.8	2.5	7.6	3.8	1.3	7.6	3.8	1.3	0	-25.4	5.1	2.5	1.3		

(2) Outer ring

Unit : μm

Nominal outside dia. D mm	Single plane mean outside diameter deviation ΔD_{mp}				Single outside diameter deviation ΔD_s				Single plane outside diameter variation V_{Dsp}				Mean outside diameter variation V_{Dmp}			Radial runout of assembled bearing outer ring K_{ea}			Axial runout of assembled bearing outer ring S_{ea}			Perpendicularity of outer ring outside surface with respect to the face S_D			Single outer ring flange outside diameter deviation ΔD_{1s}		Single outer ring flange width deviation ΔC_{1s}			
	classes 5P, 7P		class 9P		classes 5P, 7P		class 9P		classes 5P, 7P		class 9P		classes 5P, 7P		class 9P	class 5P		class 7P	class 9P	class 5P		class 7P	class 9P	classes 5P, 7P		classes 5P, 7P				
	upper	lower	upper	lower	upper	lower	upper	lower	upper	lower	upper	lower	upper	lower	upper	lower	upper	lower	upper	lower	upper	lower	upper	lower	upper	lower	upper	lower		
over	up to																													
-	18	0	-5.1	0	-2.5	0	-5.1	+1	-6.1	0	-2.5	2.5	5.1	1.3	2.5	5.1	1.3	5.1	3.8	1.3	7.6	5.1	1.3	7.6	3.8	1.3	0	-25.4	0	-50.8
18	30	0	-5.1	0	-3.8	0	-5.1	+1	-6.1	0	-3.8	2.5	5.1	2	2.5	5.1	2	5.1	3.8	2.5	7.6	5.1	2.5	7.6	3.8	1.3	0	-25.4	0	-50.8
30	50	0	-5.1	0	-3.8	0	-5.1	+1	-6.1	0	-3.8	2.5	5.1	2	2.5	5.1	2	5.1	3.8	2.5	7.6	5.1	2.5	7.6	3.8	1.3	0	-25.4	0	-50.8

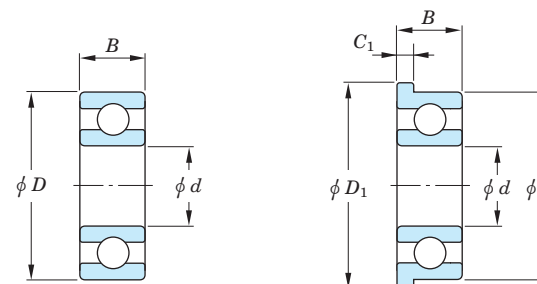

d : nominal bore diameter
 D : nominal outside diameter
 B : nominal assembled bearing width
 D_1 : nominal outer ring flange outside diameter
 C_1 : nominal outer ring flange width

Table 7-5 (1) Tolerances for metric series tapered roller bearings
= JIS B 1514-1 =

(1) Inner ring

Unit : μm

Nominal bore diameter d mm	Single plane mean bore diameter deviation Δ_{dmp}								Single bore diameter deviation Δ_{ds}				Single plane bore diameter variation V_{dsp}				Mean bore diameter variation V_{dmp}				Radial runout of assembled bearing inner ring K_{ia}						Single inner ring width deviation Δ_{Bs}						Nominal bore diameter d mm											
	classes 0, 6X		classes 6, 5		class 4		class 2		class 4		class 2		classes 0, 6X		class 6		class 5		class 4		class 2		classes 0, 6X		class 6		class 5		class 4		class 2		class 0		class 6X		class 6		classes 5, 4		class 2		over	up to
	upper	lower	upper	lower	upper	lower	upper	lower	upper	lower	upper	lower	upper	lower	upper	lower	upper	lower	upper	lower	upper	lower	upper	lower	upper	lower	upper	lower	upper	lower	upper	lower	upper	lower	upper	lower	upper	lower	over	up to				
10	0	-12	0	-7 ¹⁾	0	-5	0	-4	0	-5	0	-4	12	-	5	4	2.5	9	-	5	4	1.5	15	-	5	3	2	7	3	1.5	3	2	0	-120	0	-50	-	-	0	-200	0	-200	10	18
18	0	-12	0	-7	0	-5	0	-4	0	-5	0	-4	12	7	5	4	2.5	9	5	5	4	1.5	15	7	5	3	2	7	3	1.5	3	2	0	-120	0	-50	0	-120	0	-200	0	-200	18	30
30	0	-12	0	-8	0	-6	0	-4	0	-6	0	-4	12	8	6	5	2.5	9	6	5	4	1.5	18	8	5	3	2.5	8	4	1.5	4	2.5	0	-120	0	-50	0	-120	0	-200	0	-200	30	50
50	0	-12	0	-10	0	-8	0	-5	0	-8	0	-5	12	10	8	6	3	9	8	5	5	2	20	10	6	4	2.5	8	4	2	4	2.5	0	-120	0	-50	0	-120	0	-240	0	-240	50	80
80	0	-15	0	-12	0	-9	0	-5	0	-9	0	-5	15	12	9	7	4	11	9	6	5	2	25	10	7	4	3	8	5	2	4	3	0	-150	0	-50	0	-150	0	-300	0	-300	80	120
120	0	-20	0	-15	0	-10	0	-6	0	-10	0	-6	20	15	11	8	5	15	11	8	5	2.5	30	13	8	5	3	9	5	2.5	5	3	0	-200	0	-50	0	-200	0	-400	0	-400	120	180
180	0	-25	0	-18	0	-13	0	-7	0	-13	0	-7	25	18	14	10	7	19	14	9	7	3.5	35	18	11	6	4	10	6	3.5	7	4	0	-250	0	-50	0	-250	0	-500	0	-500	180	250
250	0	-30	0	-22	0	-15	0	-8	0	-15	0	-8	30	22	17	11	7	23	16	11	8	4	50	20	13	8	5	11	7	5	8	5	0	-300	0	-50	0	-300	0	-600	0	-600	250	315
315	0	-35	0	-25 ¹⁾	0	-18	0	-8	0	-18	0	-8	35	25	19	12	8	26	19	13	9	5	60	30	13	9	6	13	8	5.5	9	6	0	-350	0	-50	0	-350	0	-700	0	-700	315	400
400	0	-40	0	-30 ¹⁾	-	-	-	-	-	-	-	-	40	30	23	-	-	30	23	15	-	-	70	35	15	-	-	15	-	-	-	-	0	-400	0	-50	0	-400	0	-800 ²⁾	-	-	400	500
500	0	-45	0	-35 ¹⁾	-	-	-	-	-	-	-	-	45	35	28	-	-	34	26	17	-	-	80	40	20	-	-	17	-	-	-	-	0	-450	0	-50	0	-450	0	-900 ²⁾	-	-	500	630
630	0	-60	0	-40 ¹⁾	-	-	-	-	-	-	-	-	60	40	35	-	-	40	30	20	-	-	90	50	25	-	-	20	-	-	-	-	0	-500	-	-	0	-500	0	-1 100 ²⁾	-	-	630	800
800	0	-75	0	-50 ¹⁾	-	-	-	-	-	-	-	-	75	50	45	-	-	45	38	25	-	-	100	60	30	-	-	25	-	-	-	-	0	-750	-	-	0	-750	0	-1 600 ²⁾	-	-	800	1 000
1 000	0	-100	0	-60 ¹⁾	-	-	-	-	-	-	-	-	100	60	60	-	-	55	45	30	-	-	115	75	37	-	-	30	-	-	-	-	0	-1 000	-	-	0	-1 000	0	-2 000 ²⁾	-	-	800	1 000

S_d : perpendicularity of inner ring face with respect to the bore
 S_{ia} : axial runout of assembled bearing inner ring

(2-1) Outer ring

Unit : μm (2-2) Outer ring Unit : μm

Nominal outside diameter D mm	Single plane mean outside diameter deviation Δ_{Dmp}								Single outside diameter deviation Δ_{Ds}				Single plane outside diameter variation V_{Dsp}				Mean outside diameter variation V_{Dmp}				Radial runout of assembled bearing outer ring K_{ea}						Nominal outside diameter D mm								
	classes 0, 6X		classes 6, 5		class 4		class 2		class 4		class 2		classes 0, 6X		class 6		class 5		class 4		class 2		classes 0, 6X		class 6		class 5		class 4		class 2		over	up to	
	upper	lower	upper	lower	upper	lower	upper	lower	upper	lower	upper	lower	upper	lower	upper	lower	upper	lower	upper	lower	upper	lower	upper	lower	upper	lower	upper	lower	upper	lower	upper	lower	over	up to	
18	0	-12	0	-8 ¹⁾	0	-6	0	-5	0	-6	0	-5	12	-	6	5	4	9	-	5	4	2.5	18	-	6	4	2.5	8	4	1.5	5	2.5	-	18	30
30	0	-12	0	-8	0	-6	0	-5	0	-6	0	-5	12	8	6	5	4	9	6	5	4	2.5	18	9	6	4	2.5	8	4	1.5	5	2.5	18	30	50
50	0	-14	0	-9	0	-7	0	-5	0	-7	0	-5	14	9	7	5	4	11	7	5	5	2.5	20	10	7	5	2.5	8	4	2	5	2.5	30	50	80
80	0	-16	0	-11	0	-9	0	-6	0	-9	0	-6	16	11	8	7	4	12	8	6	5	2.5	25	13	8	5	4	8	4	2.5	5	4	50	80	120
120	0	-18	0	-13	0	-10	0	-6	0	-10	0	-6	18	13	10	8	5	14	10	7	5	3	35	18	10	6	5	9	5	3	6	5	80	120	150
150	0	-20	0	-15	0	-11	0	-7	0	-11	0	-7	20	15	11	8	5	15	11	8	6	3.5	40	20	11	7	5	10	5	3.5	7	5	120	150	
180	0	-25	0	-18	0	-13	0	-7	0	-13	0	-7	25	18	14	10	7	19	14	9	7	4	45	23	13	8	5	10	5	4	8	5	150	180	
250	0	-30	0	-20	0	-15	0	-8	0	-15	0	-8	30	20	15	11	8	23	15	10	8	5	50	25	15	10	7	11	7	5	10	7	180	250	
315	0	-35	0	-25	0	-18	0	-9	0	-18	0	-9	35	25	19	14	8	26	19	13	9	5	60	30	18	11	7	13	8	6	10	7	250	315	
400	0	-40	0	-28	0	-20	0	-10	0	-20	0	-10	40	28	22	15	10	30	21	14	10	6	70	35	20	13	8	13	10	7	13	8	315	400	
500	0	-45	0	-33 ¹⁾	-	-	-	-	-	-	-	-	45	33	26	-	-	34	25	17	-	-	80	40	24	-	-	17	-	-	-	-	400	500	
630	0	-50	0	-38 ¹⁾	-	-	-	-	-	-	-	-	60	38	30	-	-	38	29	20	-	-	100	50	30	-	-	20	-	-	-	-	500	630	
800	0	-75	0	-45 ¹⁾	-	-	-	-	-	-	-	-	80	45	38	-	-	55	34	25	-	-	120	60	36	-	-	25	-	-	-	-	630	800	
1 000	0	-100	0	-60 ¹⁾	-	-	-	-	-	-	-	-	100	60	50	-	-	75	45	30	-	-	140	75	43	-	-	30	-	-	-	-	800	1 000	
1 250	0	-125	0	-80 ¹⁾	-	-	-	-	-	-	-	-	130	75	65	-	-	90	56	38	-	-	160	85	52	-	-	38	-	-	-	-	1 000	1 250	
1 600	0	-160	0	-100 ¹⁾	-	-	-	-	-	-	-	-	170	90	90	-	-	100	68	50	-	-	180	95	62	-	-	50	-	-	-	-	1 250	1 600	

Nominal bore diameter d mm	Single outer ring width deviation Δ_{Cs}			
	class 6X		classes 0, 6, 5, 4, 2	
	upper	lower	upper	lower
10	0	-100	-	-
18	0	-100	-	-
30	0	-100	-	-
50	0	-100	-	-
80	0	-100	-	-
120	0	-100	-	-
180	0	-100	-	-
250	0	-100	-	-
315	0	-100	-	-
400	0	-100	-	-
500	0	-100	-	-
630	0	-100	-	-
800	0	-100	-	-
1 000	0	-100	-	-
1 250	0	-100	-	-

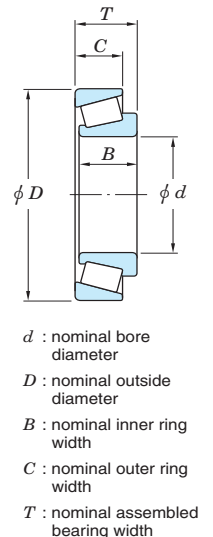

[Notes] 1) Class 6 values are prescribed in JTEKT standards.
2) These shall be applied to bearings of tolerance class 5.
3) These shall not be applied to flanged bearings.
[Remark] Values in Italics are prescribed in JTEKT standards.

S_D : perpendicularity of outer ring outside surface with respect to the face
 S_{ea} : axial runout of assembled bearing outer ring

Table 7-5 (2) Tolerances for metric series tapered roller bearings

(3) Assembled bearing width and effective width

Unit : μm

Nominal bore diameter d mm		Actual bearing width deviation ΔT_s								Actual effective inner sub-unit width deviation ΔT_{1s}									
		class 0		class 6X		class 6		classes 5, 4		class 2		class 0		class 6X		classes 5, 4		class 2	
		upper	lower	upper	lower	upper	lower	upper	lower	upper	lower	upper	lower	upper	lower	upper	lower	upper	lower
over	up to																		
-	10	+200	0	+100	0	-	-	+200	-200	+200	-200	+100	0	+50	0	+100	-100	+100	-100
10	18	+200	0	+100	0	+200	0	+200	-200	+200	-200	+100	0	+50	0	+100	-100	+100	-100
18	30	+200	0	+100	0	+200	0	+200	-200	+200	-200	+100	0	+50	0	+100	-100	+100	-100
30	50	+200	0	+100	0	+200	0	+200	-200	+200	-200	+100	0	+50	0	+100	-100	+100	-100
50	80	+200	0	+100	0	+200	0	+200	-200	+200	-200	+100	0	+50	0	+100	-100	+100	-100
80	120	+200	-200	+100	0	+200	-200	+200	-200	+200	-200	+100	-100	+50	0	+100	-100	+100	-100
120	180	+350	-250	+150	0	+350	-250	+350	-250	+200	-250	+150	-150	+50	0	+150	-150	+100	-100
180	250	+350	-250	+150	0	+350	-250	+350	-250	+200	-300	+150	-150	+50	0	+150	-150	+100	-150
250	315	+350	-250	+200	0	+350	-250	+350	-250	+200	-300	+150	-150	+100	0	+150	-150	+100	-150
315	400	+400	-400	+200	0	+400	-400	+400	-400 ¹⁾	-	-	+200	-200	+100	0	+200	-200 ¹⁾	-	-
400	500	+450	-450	+200	0	+400	-400	+450	-450 ¹⁾	-	-	+225	-225	+100	0	+225	-225 ¹⁾	-	-
500	630	+500	-500	-	-	+500	-500	+500	-500 ¹⁾	-	-	-	-	-	-	-	-	-	-
630	800	+600	-600	-	-	+600	-600	+600	-600 ¹⁾	-	-	-	-	-	-	-	-	-	-
800	1 000	+750	-750	-	-	+750	-750	+750	-750 ¹⁾	-	-	-	-	-	-	-	-	-	-

Nominal bore diameter d mm		Actual effective outer ring width deviation ΔT_{2s}							
		class 0		class 6X		classes 5, 4		class 2	
		upper	lower	upper	lower	upper	lower	upper	lower
over	up to								
-	10	+100	0	+50	0	+100	-100	+100	-100
10	18	+100	0	+50	0	+100	-100	+100	-100
18	30	+100	0	+50	0	+100	-100	+100	-100
30	50	+100	0	+50	0	+100	-100	+100	-100
50	80	+100	0	+50	0	+100	-100	+100	-100
80	120	+100	-100	+50	0	+100	-100	+100	-100
120	180	+200	-100	+100	0	+200	-100	+100	-150
180	250	+200	-100	+100	0	+200	-100	+100	-150
250	315	+200	-100	+100	0	+200	-100	+100	-150
315	400	+200	-200	+100	0	+200	-200 ¹⁾	-	-
400	500	+225	-225	+100	0	+225	-225 ¹⁾	-	-
500	630	-	-	-	-	-	-	-	-
630	800	-	-	-	-	-	-	-	-
800	1 000	-	-	-	-	-	-	-	-

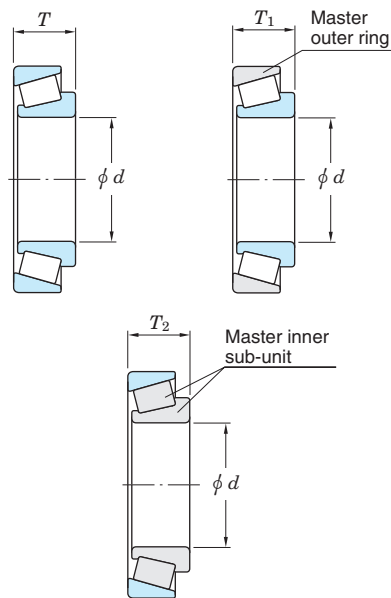

d : nominal bore diameter
 T : nominal assembled bearing width
 T_1 : nominal effective width of inner sub-unit
 T_2 : nominal effective width of outer ring

[Note] 1) These shall be applied to bearings of tolerance class 5.
 [Remark] Values in Italics are prescribed in JTEKT standards.

Table 7-6 Tolerances for metric series double-row and four-row tapered roller bearings (class 0) = BAS 1002 =

(1) Inner ring, outer ring width and overall width

Unit : μm

Nominal bore diameter d mm		Single plane mean bore diameter deviation Δd_{mp}		Single plane bore diameter variation V_{dsp}	Mean bore diameter variation V_{dmp}	K_{ia}	Single outer ring or inner ring width deviation $\Delta B_s, \Delta C_s$		Actual overall inner rings/outer rings width deviation			
									Double-row ΔT_s		Four-row $\Delta T_s, \Delta W_s$	
									upper	lower	upper	lower
over	up to			max.	max.	max.						
30	50	0	-12	12	9	20	0	-120	+240	-240	-	-
50	80	0	-15	15	11	25	0	-150	+300	-300	-	-
80	120	0	-20	20	15	30	0	-200	+400	-400	+500	-500
120	180	0	-25	25	19	35	0	-250	+500	-500	+600	-600
180	250	0	-30	30	23	50	0	-300	+600	-600	+750	-750
250	315	0	-35	35	26	60	0	-350	+700	-700	+900	-900
315	400	0	-40	40	30	70	0	-400	+800	-800	+1 000	-1 000
400	500	0	-45	45	34	80	0	-450	+900	-900	+1 200	-1 200
500	630	0	-60	60	40	90	0	-500	+1 000	-1 000	+1 200	-1 200
630	800	0	-75	75	45	100	0	-750	+1 500	-1 500	-	-
800	1 000	0	-100	100	55	115	0	-1 000	+1 500	-1 500	-	-

K_{ia} : radial runout of assembled bearing inner ring

(2) Outer ring

Unit : μm

Nominal outside diameter D mm		Single plane mean outside diameter deviation ΔD_{mp}		Single plane outside diameter variation V_{Dsp}	Mean outside diameter variation V_{Dmp}	K_{ea}					
							upper	lower	max.	max.	max.
							over	up to			
50	80	0	-16	16	12	25					
80	120	0	-18	18	14	35					
120	150	0	-20	20	15	40					
150	180	0	-25	25	19	45					
180	250	0	-30	30	23	50					
250	315	0	-35	35	26	60					
315	400	0	-40	40	30	70					
400	500	0	-45	45	34	80					
500	630	0	-50	60	38	100					
630	800	0	-75	80	55	120					
800	1 000	0	-100	100	75	140					
1 000	1 250	0	-125	130	90	160					
1 250	1 600	0	-160	170	100	180					

K_{ea} : radial runout of assembled bearing outer ring

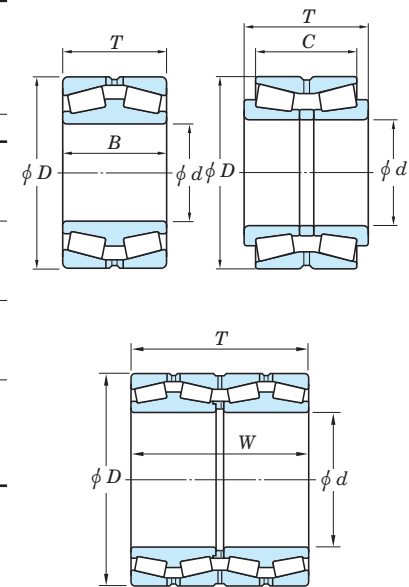

d : nominal bore diameter
 D : nominal outside diameter
 B : nominal double inner ring width
 C : nominal double outer ring width
 T, W : nominal overall width of outer rings (inner rings)

Table 7-7 Tolerances and permissible values for inch series tapered roller bearings = ANSI/ABMA 19 =

(1) Inner ring Unit : μm

Applied bearing type	Nominal bore diameter <i>d</i> , mm (1/25.4)		Deviation of a single bore diameter Δ_{ds}									
			class 4		class 2		class 3		class 0		class 00	
	over	up to	upper	lower	upper	lower	upper	lower	upper	lower	upper	lower
All types	-	76.2 (3.0)	+ 13	0	+ 13	0	+ 13	0	+ 13	0	+ 8	0
	76.2 (3.0)	266.7 (10.5)	+ 25	0	+ 25	0	+ 13	0	+ 13	0	+ 8	0
	266.7 (10.5)	304.8 (12.0)	+ 25	0	+ 25	0	+ 13	0	+ 13	0	+ 8	0
	304.8 (12.0)	609.6 (24.0)	+ 51	0	+ 51	0	+ 25	0	-	-	-	-
	609.6 (24.0)	914.4 (36.0)	+ 76	0	-	-	+ 38	0	-	-	-	-
	914.4 (36.0)	1 219.2 (48.0)	+ 102	0	-	-	+ 51	0	-	-	-	-
	1 219.2 (48.0)	-	+ 127	0	-	-	+ 76	0	-	-	-	-

(2) Outer ring Unit : μm

Applied bearing type	Nominal outside diameter <i>D</i> , mm (1/25.4)		Deviation of a single outside diameter Δ_{Ds}									
			class 4		class 2		class 3		class 0		class 00	
	over	up to	upper	lower	upper	lower	upper	lower	upper	lower	upper	lower
All types	-	266.7 (10.5)	+ 25	0	+ 25	0	+ 13	0	+ 13	0	+ 8	0
	266.7 (10.5)	304.8 (12.0)	+ 25	0	+ 25	0	+ 13	0	+ 13	0	+ 8	0
	304.8 (12.0)	609.6 (24.0)	+ 51	0	+ 51	0	+ 25	0	-	-	-	-
	609.6 (24.0)	914.4 (36.0)	+ 76	0	+ 76	0	+ 38	0	-	-	-	-
	914.4 (36.0)	1 219.2 (48.0)	+ 102	0	-	-	+ 51	0	-	-	-	-
	1 219.2 (48.0)	-	+ 127	0	-	-	+ 76	0	-	-	-	-

(3) Radial runout of assembled bearing inner ring/outer ring Unit : μm

Applied bearing type	Nominal outside diameter <i>D</i> , mm (1/25.4)		Radial runout of inner ring/outer ring K_{ia}, K_{ea}				
			class 4	class 2	class 3	class 0	class 00
	over	up to	max.	max.	max.	max.	max.
All types	-	266.7 (10.5)	51	38	8	4	2
	266.7 (10.5)	304.8 (12.0)	51	38	8	4	2
	304.8 (12.0)	609.6 (24.0)	51	38	18	-	-
	609.6 (24.0)	914.4 (36.0)	76	51	51	-	-
	914.4 (36.0)	1 219.2 (48.0)	76	-	76	-	-
	1 219.2 (48.0)	-	76	-	76	-	-

(4) Assembled bearing width and overall width Unit : μm

Applied bearing type	Nominal bore diameter <i>d</i> , mm (1/25.4)		Nominal outside diameter <i>D</i> , mm (1/25.4)		Deviation of the actual bearing width and overall width of inner rings/outer rings Δ_{Ts}, Δ_{Ws}							
					class 4		class 2		class 3		classes 0,00	
	over	up to	over	up to	upper	lower	upper	lower	upper	lower	upper	lower
Single-row	-	101.6 (4.0)	-	-	+ 203	0	+ 203	0	+ 203	- 203	+ 203	- 203
	101.6 (4.0)	266.7 (10.5)	-	-	+ 356	- 254	+ 203	0	+ 203	- 203	+ 203	- 203
	266.7 (10.5)	304.8 (12.0)	-	-	+ 356	- 254	+ 203	0	+ 203	- 203	+ 203	- 203 ¹⁾
	304.8 (12.0)	609.6 (24.0)	-	508.0 (20.0)	-	-	+ 381	- 381	+ 203	- 203	-	-
	304.8 (12.0)	609.6 (24.0)	508.0 (20.0)	-	-	-	+ 381	- 381	+ 381	- 381	-	-
	609.6 (24.0)	-	-	-	+ 381	- 381	-	-	+ 381	- 381	-	-
Double-row	-	101.6 (4.0)	-	-	+ 406	0	+ 406	0	+ 406	- 406	+ 406	- 406
	101.6 (4.0)	266.7 (10.5)	-	-	+ 711	- 508	+ 406	- 203	+ 406	- 406	+ 406	- 406
	266.7 (10.5)	304.8 (12.0)	-	-	+ 711	- 508	+ 406	- 203	+ 406	- 406	+ 406	- 406 ¹⁾
	304.8 (12.0)	609.6 (24.0)	-	508.0 (20.0)	-	-	+ 762	- 762	+ 406	- 406	-	-
	304.8 (12.0)	609.6 (24.0)	508.0 (20.0)	-	-	-	+ 762	- 762	+ 762	- 762	-	-
609.6 (24.0)	-	-	-	+ 762	- 762	-	-	+ 762	- 762	-	-	
Double-row (TNA type)	-	127.0 (5.0)	-	-	-	-	+ 254	0	+ 254	0	-	-
	127.0 (5.0)	-	-	-	-	-	+ 762	0	+ 762	0	-	-
Four-row	Total dimensional range		-	-	+ 1 524	- 1 524	+ 1 524	- 1 524	+ 1 524	- 1 524	+ 1 524	- 1 524

[Note] 1) These shall be applied to bearings of class 0.

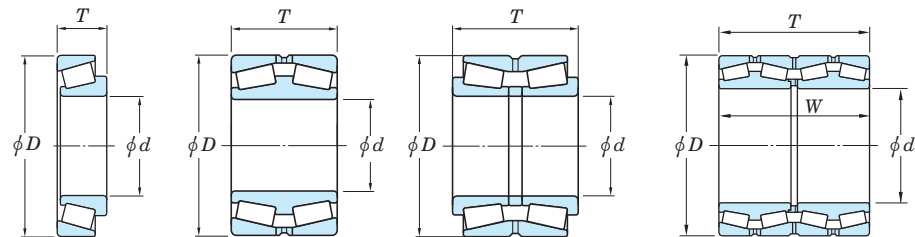

d : nominal bore diameter
D : nominal outside diameter
T, W : nominal assembled bearing width and nominal overall width of outer rings (inner rings)

Table 7-8 Tolerances for metric J series tapered roller bearings ¹⁾

(1) Bore diameter and width of inner ring and assembled bearing width

Unit : μm

Nominal bore diameter d mm		Deviation of a single bore diameter Δ_{ds}								Deviation of a single inner ring width Δ_{Bs}								Deviation of the actual bearing width Δ_{Ts}								Nominal bore diameter d mm	
		class PK		class PN		class PC		class PB		class PK		class PN		class PC		class PB		class PK		class PN		class PC		class PB			
over	up to	upper	lower	upper	lower	upper	lower	upper	lower	upper	lower	upper	lower	upper	lower	upper	lower	upper	lower	upper	lower	upper	lower	upper	lower	over	up to
10	18	0	-12	0	-12	0	-7	0	-5	0	-100	0	-50	0	-200	0	-200	+200	0	+100	0	+200	-200	+200	-200	10	18
18	30	0	-12	0	-12	0	-8	0	-6	0	-100	0	-50	0	-200	0	-200	+200	0	+100	0	+200	-200	+200	-200	18	30
30	50	0	-12	0	-12	0	-10	0	-8	0	-100	0	-50	0	-200	0	-200	+200	0	+100	0	+200	-200	+200	-200	30	50
50	80	0	-15	0	-15	0	-12	0	-9	0	-150	0	-50	0	-300	0	-300	+200	0	+100	0	+200	-200	+200	-200	50	80
80	120	0	-20	0	-20	0	-15	0	-10	0	-150	0	-50	0	-300	0	-300	+200	-200	+100	0	+200	-200	+200	-200	80	120
120	180	0	-25	0	-25	0	-18	0	-13	0	-200	0	-50	0	-300	0	-300	+350	-250	+150	0	+350	-250	+200	-250	120	180
180	250	0	-30	0	-30	0	-22	0	-15	0	-200	0	-50	0	-350	0	-350	+350	-250	+150	0	+350	-250	+200	-300	180	250
250	315	0	-35	0	-35	0	-22	0	-15	0	-200	0	-50	0	-350	0	-350	+350	-250	+200	0	+350	-300	+200	-300	250	315

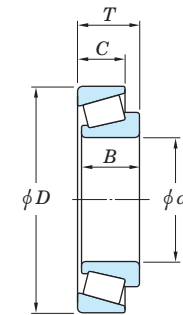

d : nominal bore diameter
 D : nominal outside diameter
 B : nominal inner ring width
 C : nominal outer ring width
 T : nominal assembled bearing width

(2) Outside diameter and width of outer ring and radial runout of assembled bearing inner ring/outer ring

Unit : μm

Nominal outside diameter D mm		Deviation of a single outside diameter Δ_{Ds}								Deviation of a single outer ring width Δ_{Cs}								Radial runout of inner ring/outer ring K_{ia}, K_{ea}				Nominal outside diameter D mm	
		class PK		class PN		class PC		class PB		class PK		class PN		class PC		class PB		class PK	class PN	class PC	class PB		
over	up to	upper	lower	upper	lower	upper	lower	upper	lower	upper	lower	upper	lower	upper	lower	upper	lower	upper	lower	upper	lower	over	up to
18	30	0	-12	0	-12	0	-8	0	-6	0	-150	0	-100	0	-150	0	-150	18	18	5	3	18	30
30	50	0	-14	0	-14	0	-9	0	-7	0	-150	0	-100	0	-150	0	-150	20	20	6	3	30	50
50	80	0	-16	0	-16	0	-11	0	-9	0	-150	0	-100	0	-150	0	-150	25	25	6	4	50	80
80	120	0	-18	0	-18	0	-13	0	-10	0	-200	0	-100	0	-200	0	-200	35	35	6	4	80	120
120	150	0	-20	0	-20	0	-15	0	-11	0	-200	0	-100	0	-200	0	-200	40	40	7	4	120	150
150	180	0	-25	0	-25	0	-18	0	-13	0	-200	0	-100	0	-250	0	-250	45	45	8	4	150	180
180	250	0	-30	0	-30	0	-20	0	-15	0	-250	0	-100	0	-250	0	-250	50	50	10	5	180	250
250	315	0	-35	0	-35	0	-25	0	-18	0	-250	0	-100	0	-300	0	-300	60	60	11	5	250	315
315	400	0	-40	0	-40	0	-28	-	-	0	-250	0	-100	0	-300	-	-	70	70	13	-	315	400

[Note] 1) Bearings with supplementary code "J" attached at the front of bearing number
 Ex. JHM720249/JHM720210, and the like

7. Bearing tolerances

Table 7-9 Tolerances for thrust ball bearings = JIS B 1514-2 =

(1) Shaft race and central race

Unit : μm

Nominal bore diameter of shaft or central race d or d_2 , mm		Single plane mean bore diameter deviation Δ_{dmp} or Δ_{d2mp}				Single plane bore diameter variation V_{dsp} or V_{d2sp}		Race raceway to back face thickness variation $S_i^{1)2)}$			
		classes 0, 6, 5		class 4		classes 0, 6, 5	class 4	class 0	class 6	class 5	class 4
		upper	lower	upper	lower	max.		max.			
over	up to										
-	18	0	- 8	0	- 7	6	5	10	5	3	2
18	30	0	- 10	0	- 8	8	6	10	5	3	2
30	50	0	- 12	0	- 10	9	8	10	6	3	2
50	80	0	- 15	0	- 12	11	9	10	7	4	3
80	120	0	- 20	0	- 15	15	11	15	8	4	3
120	180	0	- 25	0	- 18	19	14	15	9	5	4
180	250	0	- 30	0	- 22	23	17	20	10	5	4
250	315	0	- 35	0	- 25	26	19	25	13	7	5
315	400	0	- 40	0	- 30	30	23	30	15	7	5
400	500	0	- 45	0	- 35	34	26	30	18	9	6
500	630	0	- 50	0	- 40	38	30	35	21	11	7
630	800	0	- 75	0	- 50	55	40	40	25	13	8
800	1 000	0	- 100	-	-	75	-	45	30	15	-
1 000	1 250	0	- 125	-	-	95	-	50	35	18	-

- [Notes] 1) Double direction thrust ball bearings shall be included in d of single direction thrust ball bearings of the same diameter series and nominal outside diameter.
 2) Applies only to thrust ball bearings and cylindrical roller thrust bearings with 90° contact angle.

(2) Housing race

Unit : μm

Nominal outside diameter D , mm		Single plane mean outside diameter deviation Δ_{Dmp}				Single plane outside diameter variation V_{Dsp}		Race raceway to back face thickness variation $S_e^{1)2)}$
		classes 0, 6, 5		class 4		classes 0, 6, 5	class 4	
		upper	lower	upper	lower	max.		
over	up to							
10	18	0	- 11	0	- 7	8	5	
18	30	0	- 13	0	- 8	10	6	
30	50	0	- 16	0	- 9	12	7	
50	80	0	- 19	0	- 11	14	8	
80	120	0	- 22	0	- 13	17	10	
120	180	0	- 25	0	- 15	19	11	
180	250	0	- 30	0	- 20	23	15	Shall conform to the tolerance S_i on d or d_2 of the same bearing
250	315	0	- 35	0	- 25	26	19	
315	400	0	- 40	0	- 28	30	21	
400	500	0	- 45	0	- 33	34	25	
500	630	0	- 50	0	- 38	38	29	
630	800	0	- 75	0	- 45	55	34	
800	1 000	0	- 100	0	- 60	75	45	
1 000	1 250	0	- 125	-	-	95	-	
1 250	1 600	0	- 160	-	-	120	-	

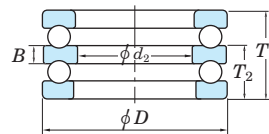
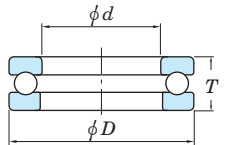

- d : shaft race nominal bore diameter
 d_2 : central race nominal bore diameter
 D : housing race nominal outside diameter
 B : central race nominal height
 T : nominal bearing height (single direction)
 T_1, T_2 : nominal bearing height (double direction)

- [Notes] 1) These shall be applied to race with flat back face only.
 2) Applies only to thrust ball bearings and cylindrical roller thrust bearings with 90° contact angle.

(3) Bearing height and central race height

Unit : μm

Nominal bore diameter d , mm		Single direction		Double direction					
		Deviation of the actual bearing height Δ_{Ts}		Deviation of the actual bearing height $\Delta_{T1s}^{1)}$		Deviation of the actual bearing height $\Delta_{T2s}^{1)}$		Deviation of a single central race height B $\Delta_{Bs}^{1)}$	
		class 0		class 0		class 0		class 0	
over	up to	upper	lower	upper	lower	upper	lower	upper	lower
-	30	0	- 75	+ 50	- 150	0	- 75	0	- 50
30	50	0	- 100	+ 75	- 200	0	- 100	0	- 75
50	80	0	- 125	+ 100	- 250	0	- 125	0	- 100
80	120	0	- 150	+ 125	- 300	0	- 150	0	- 125
120	180	0	- 175	+ 150	- 350	0	- 175	0	- 150
180	250	0	- 200	+ 175	- 400	0	- 200	0	- 175
250	315	0	- 225	+ 200	- 450	0	- 225	0	- 200
315	400	0	- 300	+ 250	- 600	0	- 300	0	- 250

[Note] 1) Double direction thrust ball bearings shall be included in d of single direction thrust ball bearings of the same diameter series and nominal outside diameter.

[Remark] Values in Italics are prescribed in JTEKT standards.

Table 7-10 Tolerances for spherical thrust roller bearings (class 0) = JIS B 1514-2 =

(1) Shaft race

Unit : μm

Nominal bore diameter d , mm		Single plane mean bore diameter deviation Δ_{dmp}		Single plane bore diameter variation V_{dsp} , max.	Refer. Actual bearing height deviation Δ_{Ts}		
		classes 0, 6, 5			class 4	classes 0, 6, 5, 4	
		upper	lower		max.	upper	lower
over	up to						
50	80	0	- 15	11	25	+ 150	- 150
80	120	0	- 20	15	25	+ 200	- 200
120	180	0	- 25	19	30	+ 250	- 250
180	250	0	- 30	23	30	+ 300	- 300
250	315	0	- 35	26	35	+ 350	- 350
315	400	0	- 40	30	40	+ 400	- 400
400	500	0	- 45	34	45	+ 450	- 450

S_d : perpendicularity of inner ring face with respect to the bore

[Remark] Values in Italics are prescribed in JTEKT standards.

(2) Housing race

Unit : μm

Nominal outside diameter D , mm		Single plane mean outside diameter deviation Δ_{Dmp}	
over	up to	upper	lower
120	180	0	- 25
180	250	0	- 30
250	315	0	- 35
315	400	0	- 40
400	500	0	- 45
500	630	0	- 50
630	800	0	- 75
800	1 000	0	- 100

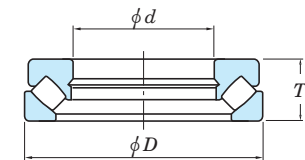

- d : shaft race nominal bore diameter
 D : housing race nominal outside diameter
 T : nominal bearing height

Table 7-11 Tolerances and permissible values for tapered bores of radial bearings

(class 0 ... JIS B 1514-1)

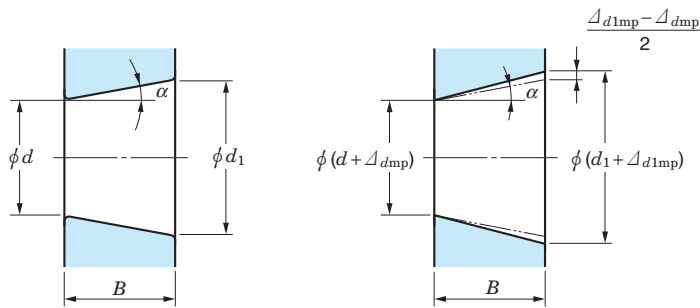

Theoretical tapered bore

Tapered bore with single plane mean bore diameter deviation

(1) Basically tapered bore (taper 1:12) Unit : μm

Nominal bore diameter d , mm		Δd_{mp}		$\Delta d_{1mp} - \Delta d_{mp}$		$V_{dsp}^{(1)}$
over	up to	upper	lower	upper	lower	max.
-	10	+ 22	0	+ 15	0	9
10	18	+ 27	0	+ 18	0	11
18	30	+ 33	0	+ 21	0	13
30	50	+ 39	0	+ 25	0	16
50	80	+ 46	0	+ 30	0	19
80	120	+ 54	0	+ 35	0	22
120	180	+ 63	0	+ 40	0	40
180	250	+ 72	0	+ 46	0	46
250	315	+ 81	0	+ 52	0	52
315	400	+ 89	0	+ 57	0	57
400	500	+ 97	0	+ 63	0	63
500	630	+ 110	0	+ 70	0	70
630	800	+ 125	0	+ 80	0	-
800	1 000	+ 140	0	+ 90	0	-
1 000	1 250	+ 165	0	+ 105	0	-
1 250	1 600	+ 195	0	+ 125	0	-

(2) Basically tapered bore (taper 1:30) Unit : μm

Nominal bore diameter d , mm		Δd_{mp}		$\Delta d_{1mp} - \Delta d_{mp}$		$V_{dsp}^{(1)}$
over	up to	upper	lower	upper	lower	max.
-	50	+ 15	0	+ 30	0	19
50	80	+ 15	0	+ 30	0	19
80	120	+ 20	0	+ 35	0	22
120	180	+ 25	0	+ 40	0	40
180	250	+ 30	0	+ 46	0	46
250	315	+ 35	0	+ 52	0	52
315	400	+ 40	0	+ 57	0	57
400	500	+ 45	0	+ 63	0	63
500	630	+ 50	0	+ 70	0	70

[Note] 1) These shall be applied to all radial planes with tapered bore, not be applied to bearings of diameter series 7, 8.

[Remark] 1) Symbols of quantity d_1 : reference diameter at theoretical large end of tapered bore

$$d_1 = d + \frac{1}{12} B \text{ or } d_1 = d + \frac{1}{30} B$$

Δd_{mp} : single plane mean bore diameter deviation at theoretical small end of tapered bore

Δd_{1mp} : single plane mean bore diameter deviation at theoretical large end of tapered bore

V_{dsp} : single plane bore diameter variation (a tolerance for the diameter variation given by a maximum value applying in any radial plane of the bore)

B : nominal inner ring width

α : $\frac{1}{2}$ of nominal tapered angle of tapered bore

(tapered ratio 1/12)

(tapered ratio 1/30)

$$\alpha = 2^\circ 23' 9.4''$$

$$\alpha = 0^\circ 57' 17.4''$$

$$= 2.385 94^\circ$$

$$= 0.954 84^\circ$$

$$= 0.041 643 \text{ rad}$$

$$= 0.016 665 \text{ rad}$$

Table 7-12 Tolerances and permissible values for flanged radial ball bearings

(1) Tolerances on flange outside diameters

Unit : μm

Nominal outer ring flange outside diameter D_1 (mm)		Deviation of single outer ring flange outside diameter, ΔD_{1s}			
		Locating flange		Non-locating flange	
over	up to	upper	lower	upper	lower
-	6	0	- 36	+ 220	- 36
6	10	0	- 36	+ 220	- 36
10	18	0	- 43	+ 270	- 43
18	30	0	- 52	+ 330	- 52
30	50	0	- 62	+ 390	- 62
50	80	0	- 74	+ 460	- 74

(2) Tolerances and permissible values on flange widths and permissible values of running accuracies relating to flanges

Unit : μm

Nominal outside diameter D (mm)		Deviation of single outer ring flange width $\Delta C_{1s}^{(1)}$	Variation of outer ring flange width $V_{C1s}^{(1)}$						Perpendicularity of outer ring outside surface with respect to the flange back face S_{D1}			Axial runout of assembled bearing outer ring flange back face S_{ea1}					
			classes 0, 6, 5, 4, 2		class 0, 6	class 5	class 4	class 2	class 5	class 4	class 2	Deep groove ball bearings and angular contact ball bearings		Tapered roller bearings			
			upper	lower	max.	max.	max.	max.	max.	max.	max.	max.	max.				
-	2.5	Shall conform to the tolerance ΔB_s on d of the same class and the bearing	Shall conform to the tolerance V_{Bs} on d of the same class and the bearing	5	2.5	1.5	8	4	1.5	8	4	1.5	11	7	3	7	4
2.5	6			5	2.5	1.5	8	4	1.5	8	4	1.5	11	7	3	7	4
6	18			5	2.5	1.5	8	4	1.5	8	4	1.5	11	7	3	7	4
18	30			5	2.5	1.5	8	4	1.5	8	4	1.5	11	7	4	7	4
30	50			5	2.5	1.5	8	4	1.5	8	4	2	11	7	4	7	4
50	80			6	3	1.5	8	4	1.5	8	4	2.5	14	7	6	7	6

[Note] 1) These shall be applied to groove ball bearings, i.e. deep groove ball bearing and angular contact ball bearing etc.

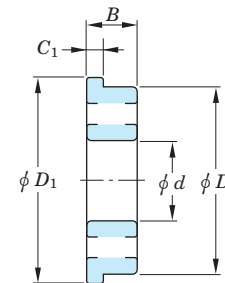

d : nominal bore diameter

D : nominal outside diameter

B : nominal assembled bearing width

D_1 : nominal outer ring flange outside diameter

C_1 : nominal outer ring flange width

7. Bearing tolerances

Table 7-13 Permissible values for chamfer dimensions = JIS B 1514-3 =

(1) Radial bearing

(tapered roller bearings excluded)

Unit : mm

r_{\min} or $r_{1\min}$	Nominal bore diameter d mm		r_{\max} or $r_{1\max}$	
	over	up to	Radial direction	Axial direction
0.05	-	-	0.1	0.2
0.08	-	-	0.16	0.3
0.1	-	-	0.2	0.4
0.15	-	-	0.3	0.6
0.2	-	-	0.5	0.8
0.3	-	40	0.6	1
	40	-	0.8	1
0.6	-	40	1	2
	40	-	1.3	2
1	-	50	1.5	3
	50	-	1.9	3
1.1	-	120	2	3.5
	120	-	2.5	4
1.5	-	120	2.3	4
	120	-	3	5
2	-	80	3	4.5
	80	220	3.5	5
	220	-	3.8	6
2.1	-	280	4	6.5
	280	-	4.5	7
2.5	-	100	3.8	6
	100	280	4.5	6
3	-	280	5	8
	280	-	5.5	8
4	-	-	6.5	9
5	-	-	8	10
6	-	-	10	13
7.5	-	-	12.5	17
9.5	-	-	15	19
12	-	-	18	24
15	-	-	21	30
19	-	-	25	38

[Remarks]

- Value of r_{\max} or $r_{1\max}$ in the axial direction of bearings with nominal width lower than 2 mm shall be the same as the value in radial direction.
- There shall be no specification for the accuracy of the shape of the chamfer surface, but its outline in the axial plane shall not be situated outside of the imaginary circle arc with a radius of r_{\min} or $r_{1\min}$ which contacts the inner ring side face and bore, or the outer ring side face and outside surface.

(2) Radial bearings with locating snap ring (snap ring groove side) and cylindrical roller bearings (separate thrust collar and loose rib side)

Unit : mm

$r_{1\min}$	Nominal bore dia. or nominal outside dia. d or D		$r_{1\max}$	
	over	up to	Radial direction	Axial direction
0.2	-	-	0.5	0.5
0.3	-	40	0.6	0.8
	40	-	0.8	0.8
0.5	-	40	1	1.5
	40	-	1.3	1.5
0.6	-	40	1	1.5
	40	-	1.3	1.5
1	-	50	1.5	2.2
	50	-	1.9	2.2
1.1	-	120	2	2.7
	120	-	2.5	2.7
1.5	-	120	2.3	3.5
	120	-	3	3.5
2	-	80	3	4
	80	220	3.5	4
	220	-	3.8	4
2.1	-	280	4	4.5
	280	-	4.5	4.5
2.5	-	100	3.8	5
	100	280	4.5	5
3	-	280	5	5.5
	280	-	5.5	5.5
4	-	-	6.5	6.5
5	-	-	8	8
6	-	-	10	10

[Remark] There shall be no specification for the accuracy of the shape of the chamfer surface, but its outline in the axial plane shall not be situated outside of the imaginary circle arc with a radius of $r_{1\min}$ which contacts the inner ring side face and bore, or the outer ring side face and outside surface.

(3) Cylindrical roller bearings (non-rib side) and angular contact ball bearings (front face side)

Unit : mm

$r_{1\min}$	Nominal bore dia. or nominal outside dia. d or D		$r_{1\max}$	
	over	up to	Radial direction	Axial direction
0.1	-	-	0.2	0.4
0.15	-	-	0.3	0.6
0.2	-	-	0.5	0.8
0.3	-	40	0.6	1
	40	-	0.8	1
0.6	-	40	1	2
	40	-	1.3	2
1	-	50	1.5	3
	50	-	1.9	3
1.1	-	120	2	3.5
	120	-	2.5	4
1.5	-	120	2.3	4
	120	-	3	5
2	-	80	3	4.5
	80	220	3.5	5
	220	-	3.8	6

[Remark] There shall be no specification for the accuracy of the shape of the chamfer surface, but its outline in the axial plane shall not be situated outside of the imaginary circle arc with a radius of $r_{1\min}$ which contacts the inner ring side face and bore, or the outer ring side face and outside surface.

(4) Metric series tapered roller bearing

Unit : mm

r_{\min} or $r_{1\min}$	Nominal bore dia. or nominal outside dia. ¹⁾ d or D , mm		r_{\max} or $r_{1\max}$	
	over	up to	Radial direction	Axial direction
0.3	-	40	0.7	1.4
	40	-	0.9	1.6
0.6	-	40	1.1	1.7
	40	-	1.3	2
1	-	50	1.6	2.5
	50	-	1.9	3
1.5	-	120	2.3	3
	120	250	2.8	3.5
	250	-	3.5	4
2	-	120	2.8	4
	120	250	3.5	4.5
	250	-	4	5
2.5	-	120	3.5	5
	120	250	4	5.5
	250	-	4.5	6
3	-	120	4	5.5
	120	250	4.5	6.5
	250	400	5	7
4	-	120	5	7
	120	250	5.5	7.5
	250	400	6	8
5	-	180	6.5	8
	180	-	7.5	9
6	-	180	7.5	10
	180	-	9	11
7.5	-	-	12.5	17
9.5	-	-	15	19

[Note] 1) Inner ring shall be included in division d , and outer ring, in division D .

[Remarks]

- There shall be no specification for the accuracy of the shape of the chamfer surface, but its outline in the axial plane shall not be situated outside of the imaginary circle arc with a radius of r_{\min} or $r_{1\min}$ which contacts the inner ring back face and bore, or the outer ring back face and outside surface.
- Values in italics are provided in JTEKT standards.

(5) Thrust bearing

Unit : mm

r_{\min} or $r_{1\min}$	r_{\max} or $r_{1\max}$
	Radial and axial direction
0.05	0.1
0.08	0.16
0.1	0.2
0.15	0.3
0.2	0.5
0.3	0.8
0.6	1.5
1	2.2
1.1	2.7
1.5	3.5
2	4
2.1	4.5
3	5.5
4	6.5
5	8
6	10
7.5	12.5
9.5	15
12	18
15	21
19	25

[Remark] There shall be no specification for the accuracy of the shape of the chamfer surface, but its outline in the axial plane shall not be situated outside of the imaginary circle arc with a radius of r_{\min} or $r_{1\min}$ which contacts with the shaft or central race back face and bore, or the housing race back face and outside surface.

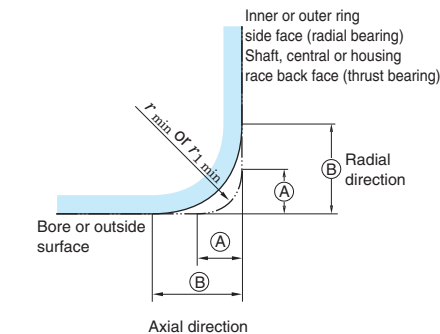

(A) : r_{\min} or $r_{1\min}$
(B) : r_{\max} or $r_{1\max}$

7-2 Tolerance measuring method (reference)

The details on measuring methods for bearings are prescribed in JIS B 1515-2. This section outlines measuring methods for dimensional and running accuracy.

Dimensional accuracy (1)

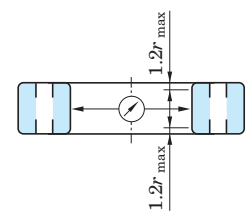
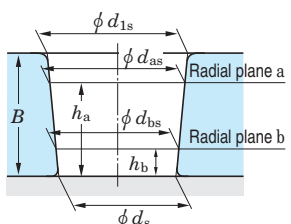
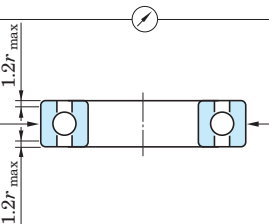
<p>Bore diameter (<i>d</i>) Cylindrical bore bearings</p>	<p>Obtain the maximum value ($d_{sp\ max}$) and the minimum value ($d_{sp\ min}$) of the bore diameter (d_s) acquired in a single radial plane. Obtain the single plane mean bore diameter (d_{mp}) as the arithmetic mean value of the maximum value ($d_{sp\ max}$) and minimum values ($d_{sp\ min}$).</p>  $d_{mp} = \frac{d_{sp\ max} + d_{sp\ min}}{2}$ <p>Single plane mean bore diameter deviation ; $\Delta d_{mp} = d_{mp} - d$ Bore diameter variation in a single plane ; $V_{dsp} = d_{sp\ max} - d_{sp\ min}$ Mean bore diameter variation ; $V_{dmp} = d_{mp\ max} - d_{mp\ min}$ Deviation of a single bore diameter ; $\Delta d_s = d_s - d$</p>
<p>Bore diameter (<i>d</i>) Tapered bore bearings</p>	<p>Bore diameter at the theoretical small end and bore diameter at the theoretical large end ;</p> $d_s = \frac{d_{bs} \cdot h_a - d_{as} \cdot h_b}{h_a - h_b}$ $d_{1s} = \frac{d_{as}(B - h_b) - d_{bs}(B - h_a)}{h_a - h_b}$ <p>Single plane mean bore diameter deviation at the theoretical small end ; $\Delta d_{mp} = d_{mp} - d$ Deviation on taper ; $(\Delta d_{1mp} - \Delta d_{mp}) = (d_{1mp} - d_1) - (d_{mp} - d)$ Bore diameter variation in a single plane ; $V_{dsp} = d_{sp\ max} - d_{sp\ min}$</p> 
<p>Outside diameter (<i>D</i>)</p>	<p>Obtain the single plane mean outside diameter (D_{mp}) as the arithmetical mean value of the maximum value ($D_{sp\ max}$) and the minimum value ($D_{sp\ min}$) of the outside diameters (D_s) acquired in a single radial plane.</p>  $D_{mp} = \frac{D_{sp\ max} + D_{sp\ min}}{2}$ <p>Single plane mean outside diameter deviation ; $\Delta D_{mp} = D_{mp} - D$ Outside diameter variation in a single plane ; $V_{Dsp} = D_{sp\ max} - D_{sp\ min}$ Mean outside diameter variation ; $V_{Dmp} = D_{mp\ max} - D_{mp\ min}$ Deviation of a single outside diameter ; $\Delta D_s = D_s - D$</p>

Dimensional accuracy (2)

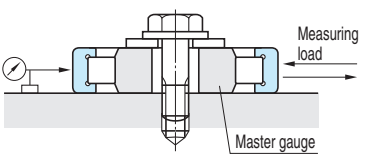
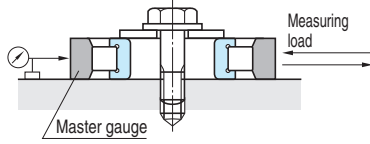
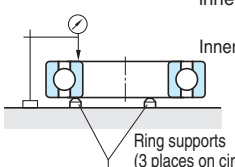
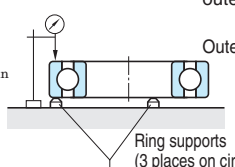
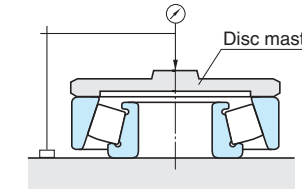
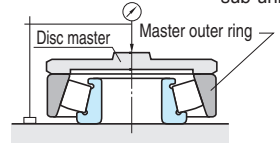
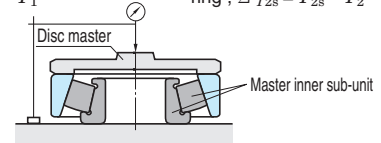
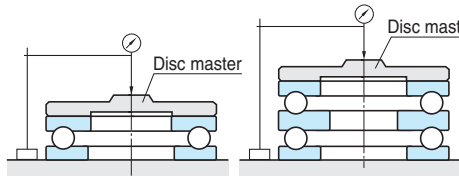
<p>Roller set bore diameter (F_w)</p>	 <p>Deviation of the roller set bore diameter ; $\Delta F_w = (d_G + \delta_{1m}) - F_w$ Deviation of the minimum diameter of the roller set bore diameter ; $\Delta F_{w\ min} = (d_G + \delta_{1min}) - F_w$ (d_G) outside diameter of the master gauge (δ_{1m}) arithmetical mean value of the amount of movement of the outer ring (δ_{1min}) minimum value of the amount of movement of the outer ring</p>
<p>Roller set outside diameter (E_w)</p>	 <p>Deviation of the roller set outside diameter ; $\Delta E_w = (D_G + \delta_{2m}) - E_w$ (D_G) bore diameter of the master gauge (δ_{2m}) arithmetical mean value of the amount of movement of the master gauge</p>
<p>Inner ring width (<i>B</i>)</p>	<p>Deviation of a single inner ring width ; $\Delta B_s = B_s - B$ Inner ring width variation ; $V_{Bs} = B_{s\ max} - B_{s\ min}$</p>  <p>Outer ring width (<i>C</i>)</p> <p>Deviation of a single outer ring width ; $\Delta C_s = C_s - C$ Outer ring width variation ; $V_{Cs} = C_{s\ max} - C_{s\ min}$</p> 
<p>Assembled bearing width of tapered roller bearing (<i>T</i>)</p>	 <p>Deviation of the actual bearing width ; $\Delta T_s = T_s - T$</p>
<p>Nominal effective width of tapered roller bearing (T_1, T_2)</p>	<p>Deviation of the actual effective width of inner sub-unit ; $\Delta T_{1s} = T_{1s} - T_1$</p>  <p>Deviation of the actual effective width of outer ring ; $\Delta T_{2s} = T_{2s} - T_2$</p> 
<p>Nominal height of thrust ball bearing with flat back face (<i>T, T_1</i>)</p>	 <p>Deviation of the actual bearing height ; $\Delta T_s = T_s - T$ (single direction) $\Delta T_{1s} = T_{1s} - T_1$ (double direction)</p>

Running accuracy (1)

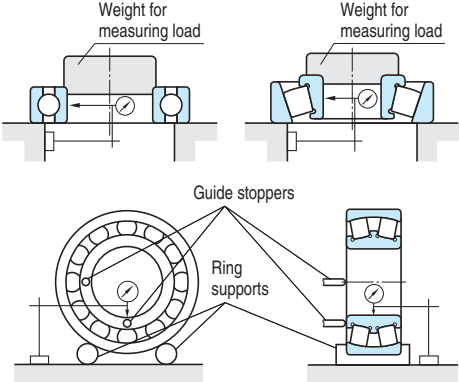
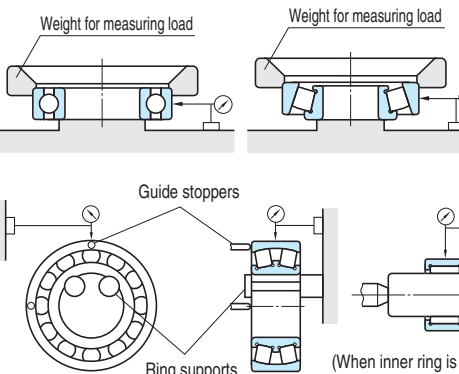
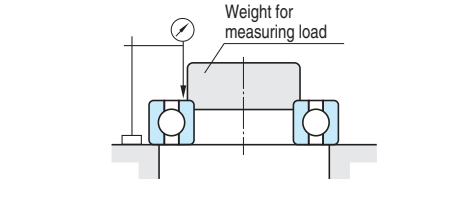
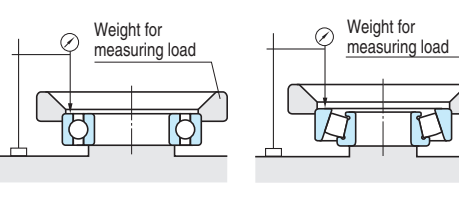
<p>Radial runout of assembled bearing inner ring (K_{ia})</p>		<p>The radial runout of the inner ring (K_{ia}) shall be obtained as the difference between the maximum value and the minimum value of the readings of the measuring instrument, when the inner ring has been rotated through one rotation.</p> <p>[Note] The measurement of the radial runout of the inner ring of cylindrical roller bearings, machined ring needle roller bearings, self-aligning ball bearings and spherical roller bearings shall be carried out by fixing the outer ring with ring supports.</p>
<p>Radial runout of assembled bearing outer ring (K_{ea})</p>		<p>The measurement of outer ring runout (K_{ea}) shall be obtained as the difference between the maximum value and the minimum value of the readings of the measuring instrument, when the outer ring has been rotated through one rotation.</p> <p>[Note] The measurement of the radial runout of the outer ring of cylindrical roller bearings, machined ring needle roller bearings, self-aligning ball bearings and spherical roller bearings shall be carried out by fixing the inner ring with ring supports.</p>
<p>Axial runout of assembled bearing inner ring (S_{ia})</p>		<p>The axial runout of the inner ring (S_{ia}) shall be obtained as the difference between the maximum value and the minimum value of the readings of the measuring instrument, when the inner ring has been rotated through one rotation.</p>
<p>Axial runout of assembled bearing outer ring (S_{ea})</p>		<p>The axial runout of the outer ring (S_{ea}) shall be obtained as the difference between the maximum value and the minimum value of the readings of the measuring instrument, when the outer ring has been rotated through one rotation.</p>

Running accuracy (2)

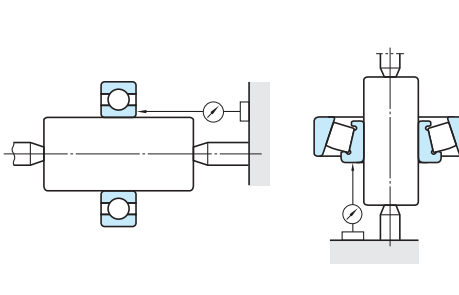
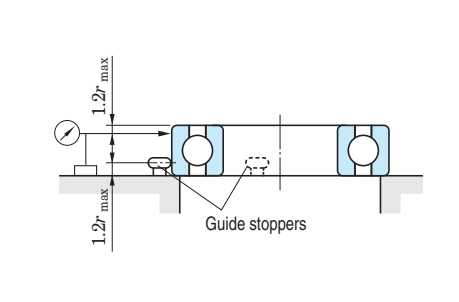
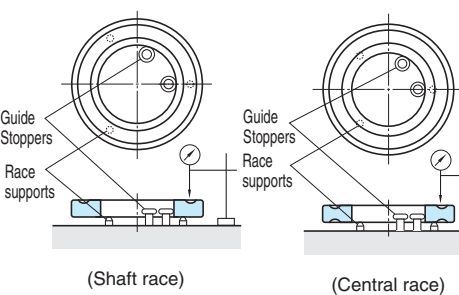
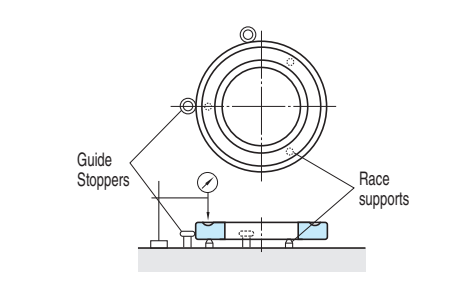
<p>Perpendicularity of inner ring face with respect to the bore (S_d)</p>		<p>Perpendicularity of inner ring face (S_d) shall be obtained as the difference between the maximum value and the minimum value of the readings of the measuring instrument, when the inner ring has been rotated through one rotation with the tapered arbor.</p>
<p>Perpendicularity of outer ring outside surface with respect to the face (S_D)</p>		<p>Perpendicularity of outer ring outside surface (S_D) shall be obtained as the difference between the maximum value and the minimum value of the readings of the measuring instrument, when the outer ring has been rotated through one rotation along the guide stopper.</p>
<p>Shaft/central race way track to back face thickness variation of thrust ball bearing with flat back face (S_i)</p>		<p>The measurement of the thickness variation (S_i) of shaft raceway track shall be obtained as the difference between the maximum value and the minimum value of the readings of the measuring instrument, when the shaft race has been rotated through one rotation along the guide stopper. For the central race, carry out the same measurement for the two raceway grooves to obtain the thickness variation of the raceway track (S_i).</p>
<p>Housing race raceway to back face thickness variation of thrust ball bearing with flat back face (S_e)</p>		<p>The measurement of the thickness variation (S_e) of housing raceway track shall be obtained as the difference between the maximum value and the minimum value of the readings of the measuring instrument, when the housing race has been rotated through one rotation along the guide stopper.</p>

8. Limiting speed

The rotational speed of a bearing is normally affected by friction heat generated in the bearing. If the heat exceeds a certain amount, seizure or other failures occur, thus causing rotation to be discontinued.

The limiting speed is the highest speed at which a bearing can continuously operate without generating such critical heat.

The limiting speed differs depending on various factors including bearing type, dimensions and their accuracy, lubrication, lubricant type and amount, shapes of cages and materials and load conditions, etc.

The limiting speed determined under grease lubrication and oil lubrication (oil bath) for each bearing type are listed in the bearing specification table.

These speeds are applied when bearings of standard design are rotated under normal load conditions (approximately, $C/P \geq 16^*$, $F_a / F_r \leq 0.25$).

Each lubricant has superior performance in use, according to type.

Some are not suitable for high speed ; when bearing rotational speed exceeds 80 % of catalog specification, consult with JTEKT.

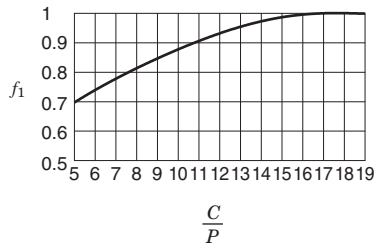

Fig. 8-1a Values of correction coefficient f_1 of load magnitude (Excludes K type bearings and railway rolling stock axle journals)

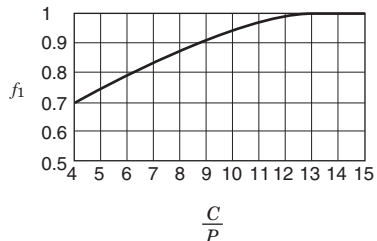

Fig. 8-1b Values of correction coefficient f_1 of load magnitude (K type bearings and railway rolling stock axle journals)

8-1 Correction of limiting speed

When the load condition is $C/P < 16^*$, i.e. the dynamic equivalent load P exceeds approximately 6* % of basic dynamic load rating C , or when a combined load in which the axial load is greater than 25 % of radial load is applied, the limiting speed should be corrected by using equation (8-1) :

$$n_a = f_1 \cdot f_2 \cdot n \quad (8-1)$$

where :

n_a : corrected limiting speed	min^{-1}
f_1 : correction coefficient determined from the load magnitude (Fig. 8-1)	
f_2 : correction coefficient determined from combined load (Fig. 8-2)	
n : limiting speed under normal load condition	min^{-1}
	(values in the bearing specification table)
C : basic dynamic load rating	N
P : dynamic equivalent load	N
F_r : radial load	N
F_a : axial load	N

* 13 (8 %) for K type bearings and railway rolling stock axle journals

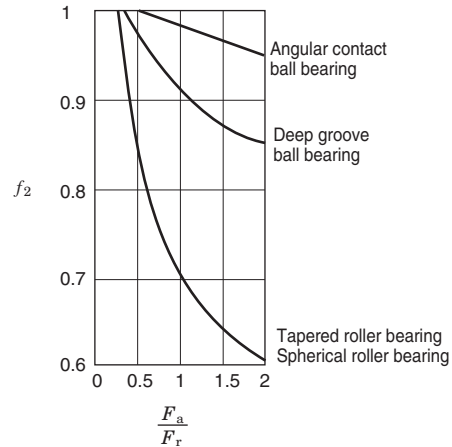

Fig. 8-2 Values of correction coefficient f_2 of combined load

8-2 Limiting speed for sealed ball bearings

The limiting speed of ball bearings with a contact seal (RS, RK type) are determined by the rubbing speed at which the seal contacts the inner ring. These allowable rubbing speeds differ depending on seal rubber materials; and, for ball bearings with the Koyo standard contact type seal (NBR), a rubbing speed of 15 m/s is utilized.

8-3 Considerations for high speed

When bearings are used for high speed, especially when the rotation speed approaches the limiting speed or exceeds it, the following should be considered :
(for further information on high speed, consult with JTEKT)

- (1) Use of high precision bearings
- (2) Study of proper internal clearance
(Reduction in internal clearance caused by temperature increase should be considered.)
- (3) Selection of proper cage type and materials
(For high speed, copper alloy or phenolic resin machined cages are suitable. Synthetic resin molded cages for high speed are also available.)
- (4) Selection of proper lubrication
(Suitable lubrication for high speed should be selected jet lubrication, oil mist lubrication and oil air lubrication, etc.)

8-4 Frictional coefficient (reference)

The frictional moment of rolling bearings can be easily compared with that of plain bearings. The frictional moment of rolling bearings can be obtained from their bore diameter, using the following equation :

$$M = \mu P \frac{d}{2} \quad (8-2)$$

where :

M : frictional moment	$\text{mN} \cdot \text{m}$
μ : frictional coefficient	
P : load on the bearing	N
d : nominal bore diameter	mm

The friction coefficient is greatly dependent on bearing type, bearing load, rotation speed and lubrication, etc.

Reference values for the friction coefficient during stable operation under normal operating conditions are listed in Table 8-1.

For plain bearings, the value is normally 0.01 to 0.02 ; but, for certain cases, it is 0.1 to 0.2.

Table 8-1 Friction coefficient μ

Bearing type	Friction coefficient μ
Deep groove ball bearing	0.001 0 – 0.001 5
Angular contact ball bearing	0.001 2 – 0.002 0
Self-aligning ball bearing	0.000 8 – 0.001 2
Cylindrical roller bearing	0.000 8 – 0.001 2
Full complement type needle roller bearing	0.002 5 – 0.003 5
Needle roller and cage assembly	0.002 0 – 0.003 0
Tapered roller bearing	0.001 7 – 0.002 5
Spherical roller bearing	0.002 0 – 0.002 5
Thrust ball bearing	0.001 0 – 0.001 5
Spherical thrust roller bearing	0.002 0 – 0.002 5

9. Bearing fits

9-1 Purpose of fit

The purpose of fit is to securely fix the inner or outer ring to the shaft or housing, to preclude detrimental circumferential sliding on the fitting surface.

Such detrimental sliding (referred to as "creep") will cause abnormal heat generation, wear of the fitting surface, infiltration of abrasion metal particles into the bearing, vibration, and many other harmful effects, which cause a deterioration of bearing functions.

Therefore, it is necessary to fix the bearing ring which is rotating under load to the shaft or housing with interference.

9-2 Tolerance and fit for shaft & housing

For metric series bearings, tolerances for the shaft diameter and housing bore diameter are standardized in JIS B 0401-1 and 0401-2 "ISO system of limits and fits - Part 1 and Part 2" (based on ISO 286; shown in Appendixes at the back of this catalogue). Bearing fits on the shaft and housing are determined based on the tolerances specified in the above standard.

Fig. 9-1 shows the relationship between tolerances for shaft and housing bore diameters and fits for bearings of class 0 tolerance.

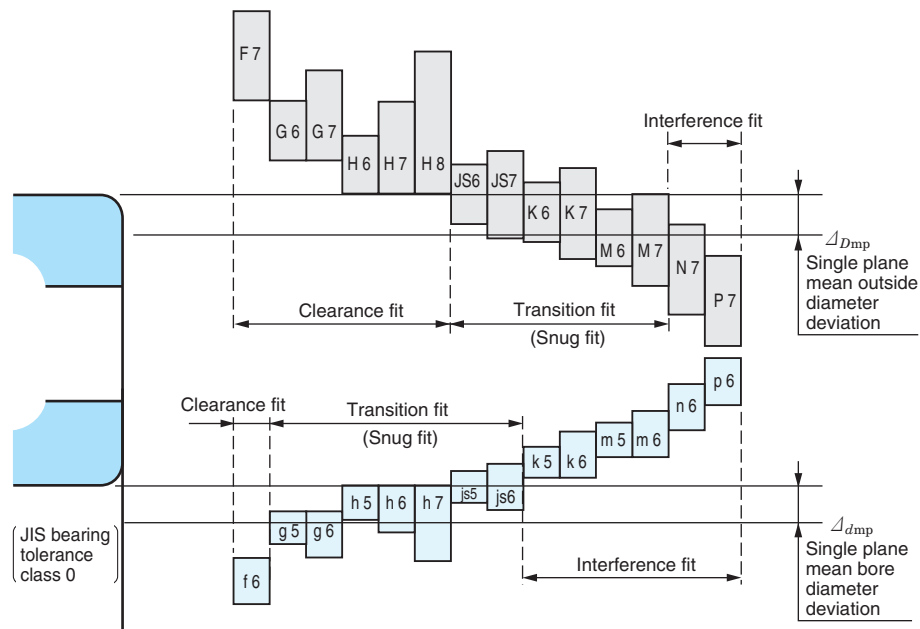

Fig. 9-1 Relationship between tolerances for shaft/housing bore diameters and fits (bearings of class 0 tolerance)

9-3 Fit selection

In selecting the proper fit, careful consideration should be given to bearing operating conditions.

Major specific considerations are :

- Load characteristics and magnitude
- Temperature distribution in operating
- Bearing internal clearance
- Surface finish, material and thickness of shaft and housing
- Mounting and dismounting methods
- Necessity to compensate for shaft thermal expansion at the fitting surface
- Bearing type and size

In view of these considerations, the following paragraphs explain the details of the important factors in fit selection.

1) Load characteristics

Load characteristics are classified into three types : rotating inner ring load; rotating outer ring load and indeterminate direction load.

Table 9-1 tabulates the relationship between these characteristics and fit.

Table 9-1 Load characteristics and fits

Rotation pattern	Direction of load	Loading conditions	Fit		Typical application
			Inner ring & shaft	Outer ring & housing	
 Inner ring : rotating Outer ring : stationary	 Stationary	Rotating inner ring load	Interference fit necessary	Clearance fit acceptable	Spur gear boxes, motors
 Inner ring : stationary Outer ring : rotating	 Rotating (with outer ring)	Stationary outer ring load	(k, m, n, p, r)	(F, G, H, JS)	Greatly unbalanced wheels
 Inner ring : stationary Outer ring : rotating	 Stationary	Stationary inner ring load	Clearance fit acceptable	Interference fit necessary	Running wheels & pulleys with stationary shaft
 Inner ring : rotating Outer ring : stationary	 Rotating (with inner ring)	Rotating outer ring load	(f, g, h, js)	(K, M, N, P)	Shaker screens (unbalanced vibration)
Indeterminate	Rotating or stationary	Indeterminate direction load	Interference fit	Interference fit	Cranks

2) Effect of load magnitude

When a radial load is applied, the inner ring will expand slightly. Since this expansion enlarges the circumference of the bore minutely, the initial interference is reduced.

The reduction can be calculated by the following equations :

[In the case of $F_r \leq 0.25 C_0$]

$$\Delta_{dF} = 0.08 \sqrt{\frac{d}{B}} \cdot F_r \times 10^{-3} \dots\dots\dots (9-1)$$

[In the case of $F_r > 0.25 C_0$]

$$\Delta_{dF} = 0.02 \frac{F_r}{B} \times 10^{-3} \dots\dots\dots (9-2)$$

where:

- Δ_{dF} : reduction of inner ring interference mm
- d : nominal bore diameter of bearing mm
- B : nominal inner ring width mm
- F_r : radial load N
- C_0 : basic static load rating N

Consequently, when the radial load, exceeds the C_0 value by more than 25 %, greater interference is needed.

Much greater interference is needed, when impact loads are expected.

3) Effect of fitting surface roughness

The effective interference obtained after fitting differs from calculated interference due to plastic deformation of the ring fitting surface.

When the inner ring is fitted, the effective interference, subject to the effect of the fitting surface finish, can be approximated by the following equations :

[In the case of a ground shaft]

$$\Delta_{deff} \doteq \frac{d}{d+2} \Delta_d \dots\dots\dots (9-3)$$

[In the case of a turned shaft]

$$\Delta_{deff} \doteq \frac{d}{d+3} \Delta_d \dots\dots\dots (9-4)$$

where:

- Δ_{deff} : effective interference mm
- Δ_d : calculated interference mm
- d : nominal bore diameter of bearing mm

4) Effect of temperature

A bearing generally has an operating temperature, higher than the ambient temperature. When the inner ring operates under load, its temperature generally becomes higher than that of the shaft and the effective interference decreases due to the greater thermal expansion of the inner ring.

If the assumed temperature difference between the bearing inside and surrounding housing is Δ_t , the temperature difference at the fitting surfaces of the inner ring and shaft will be approximately $(0.10 \text{ to } 0.15) \times \Delta_t$.

The reduction of interference (Δ_{dt}) due to temperature difference is then expressed as follows :

$$\begin{aligned} \Delta_{dt} &= (0.10 \text{ to } 0.15) \Delta_t \cdot \alpha \cdot d \\ &\doteq 0.0015 \Delta_t \cdot d \times 10^{-3} \dots\dots\dots (9-5) \end{aligned}$$

where:

- Δ_{dt} : reduction of interference due to temperature difference mm
- Δ_t : temperature difference between the inside of the bearing and the surrounding housing °C
- α : linear expansion coefficient of bearing steel ($\doteq 12.5 \times 10^{-6}$) 1/°C
- d : nominal bore diameter of bearing mm

Consequently, when a bearing is higher in temperature than the shaft, greater interference is required.

However, a difference in temperature or in the coefficient of expansion may sometimes increase the interference between outer ring and housing. Therefore, when clearance is provided to accommodate shaft thermal expansion, care should be taken.

5) Maximum stress due to fit

When a bearing is fitted with interference, the bearing ring will expand or contract, generating internal stress.

Should this stress be excessive, the bearing ring may fracture.

The maximum bearing fitting-generated stress is determined by the equation in Table 9-2.

In general, to avoid fracture, it is best to adjust the maximum interference to less than 1/1 000 of the shaft diameter, or the maximum stress (σ), determined by the equation in Table 9-2, should be less than 120 MPa.

6) Other considerations

When a high degree of accuracy is required, the tolerance of the shaft and housing must be improved. Since the housing is generally less easy to machine precisely than the shaft, it is advisable to use a clearance fit on the outer ring.

With hollow shafts or thin section housings, greater than normal interference is needed.

With split housings, on the other hand, smaller interference with outer ring is needed.

When the housing is made of aluminum or other light metal alloy, relatively greater than normal interference is needed.

In such a case, consult with JTEKT.

Table 9-2 Maximum fitting-generated stress in bearings

Shaft & inner ring	Housing bore & outer ring
(In the case of hollow shaft)	(In the case of $D_h \neq \infty$)
$\sigma = \frac{E}{2} \cdot \frac{\Delta_{deff}}{d} \cdot \frac{\left(1 - \frac{d_0^2}{d^2}\right) \left(1 + \frac{d^2}{D_i^2}\right)}{\left(1 - \frac{d_0^2}{D_i^2}\right)}$	$\sigma = E \cdot \frac{\Delta_{Deff}}{D} \cdot \frac{\left(1 - \frac{D^2}{D_h^2}\right)}{\left(1 - \frac{D_e^2}{D_h^2}\right)}$
(In the case of solid shaft)	(In the case of $D_h = \infty$)
$\sigma = \frac{E}{2} \cdot \frac{\Delta_{deff}}{d} \cdot \left(1 + \frac{d^2}{D_i^2}\right)$	$\sigma = E \cdot \frac{\Delta_{Deff}}{D}$

where :

- σ : maximum stress MPa
- d : nominal bore diameter (shaft diameter) mm
- D_i : raceway contact diameter of inner ring mm
 - ball bearing $D_i \doteq 0.2 (D + 4 d)$
 - roller bearing ... $D_i \doteq 0.25 (D + 3 d)$
- Δ_{deff} : effective interference of inner ring mm
- d_0 : bore diameter of hollow shaft mm
- D_e : raceway contact diameter of outer ring mm
 - ball bearing $D_e \doteq 0.2 (4D + d)$
 - roller bearing ... $D_e \doteq 0.25 (3D + d)$
- D : nominal outside diameter (bore diameter of housing) mm
- Δ_{Deff} : effective interference of outer ring mm
- D_h : outside diameter of housing mm
- E : young's modulus 2.08×10^5 MPa

[Remark] The above equations are applicable when the shaft and housing are steel. When other materials are used, JTEKT should be consulted.

9-4 Recommended fits

As described in Section 9-3, the characteristics / magnitude of the bearing load, temperature, mounting / dismounting methods and other conditions must be considered to choose proper fits.

Past experience is also valuable. Table 9-3 shows standard fits for the metric series bearings; Tables 9-4 to 9-8 tabulate the most typical and recommended fits for different bearings types.

Table 9-3 Standard fits for metric series bearings¹⁾

(1) Fits for bore diameter²⁾ of radial bearings

Class of bearing	Rotating inner ring load or indeterminate direction load					Stationary inner ring load				
	Class of shaft tolerance range									
Classes 0, 6X, 6	r 6	p 6	n 6	m 6 m 5	k 6 k 5	js 6 js 5	h 5	h 6 h 5	g 6 g 5	f 6
Class 5	-	-	-	m 5	k 4	js 4	h 4	h 5	-	-
Fit	Interference fit					Transition fit			Clearance fit	

(2) Fits for outside diameter²⁾ of radial bearings

Class of bearing	Stationary outer ring load			Indeterminate direction load or rotating outer ring load						
	Class of housing bore tolerance range									
Classes 0, 6X, 6	G 7	H 7 H 6	JS 7 JS 6	-	JS 7 JS 6	K 7 K 6	M 7 M 6	N 7 N 6	P 7	
Class 5	-	H 5	JS 5	K 5	-	K 5	M 5	-	-	
Fit	Clearance fit			Transition fit					Interference fit	

(3) Fits for bore diameter²⁾ of thrust bearings

Class of bearing	Central axial load (generally for thrust bearings)		Combined load (in the case of spherical thrust roller bearing)				
			Rotating shaft race load or indeterminate direction load		Stationary shaft race load		
Class of shaft tolerance range							
Classes 0, 6	js 6	h 6	n 6	m 6	k 6		js 6
Fit	Transition fit		Interference fit			Transition fit	

(4) Fits for outside diameter²⁾ of thrust bearings

Class of bearing	Central axial load (generally for thrust bearings)		Combined load (in the case of spherical thrust roller bearing)				
			Stationary housing race load or indeterminate direction load		Rotating housing race load		
Class of housing bore tolerance range							
Classes 0, 6	-	H 8	G 7	H 7	JS 7	K 7	M 7
Fit	Clearance fit			Transition fit			

[Notes] 1) Bearings specified in JIS B 1512
2) Follow JIS B 1514-1 and 1514-2 for tolerance.

Table 9-4 (1) Recommended shaft fits for radial bearings (classes 0, 6X, 6)

Conditions ¹⁾	Ball bearing	Cylindrical roller bearing Tapered roller bearing		Spherical roller bearing		Class of shaft tolerance range	Remarks	Applications (for reference)		
		Shaft diameter (mm)								
	over	up to	over	up to	over	up to				
Cylindrical bore bearing (classes 0, 6X, 6)										
Rotating inner ring load or indeterminate direction load	Light load or fluctuating load $\left(\frac{P_r}{C_r} \leq 0.05\right)$	-	18	-	-	-	-	h 5 js 6 k 6	For applications requiring high accuracy, js 5, k 5 and m 5 should be used in place of js 6, k 6 and m 6.	Electric appliances, machine tools, pumps, blowers, carriers etc.
		18	100	-	40	-	-			
		100	200	40	140	-	-			
Rotating inner ring load or indeterminate direction load	Normal load $\left(0.05 < \frac{P_r}{C_r} \leq 0.10\right)$	-	18	-	-	-	-	js 5 k 5 m 5	For single-row tapered roller bearings and angular contact ball bearings, k 5 and m 5 may be replaced by k 6 and m 6, because internal clearance reduction due to fit need not be considered.	Electric motors, turbines, internal combustion engines, wood-working machines etc.
		18	100	-	40	-	40			
		100	140	40	100	40	65			
		140	200	100	140	65	100	m 6		
		200	280	140	200	100	140	n 6		
		-	-	200	400	140	280	p 6		
-	-	-	-	280	500	r 6				
Rotating inner ring load or indeterminate direction load	Heavy load or impact load $\left(\frac{P_r}{C_r} > 0.10\right)$	-	-	50	140	50	100	n 6	Bearings with larger internal clearance than standard are required.	Railway rolling stock axle journals, traction motors
		-	-	140	200	100	140	p 6		
		-	-	200	-	140	200	r 6		
Stationary inner ring load	Inner ring needs to move smoothly on shaft.	All shaft diameters				g 6		For applications requiring high accuracy, g 5 should be used. For large size bearing, f 6 may be used for easier movement.	Stationary shaft wheels	
		Inner ring does not need to move smoothly on shaft.	All shaft diameters				h 6		For applications requiring high accuracy, h 5 should be used.	Tension pulleys, rope sheaves etc.
Central axial load only			All shaft diameters				js 6		-	
Tapered bore bearing (class 0) (with adapter or withdrawal sleeve)										
All loads		All shaft diameters				h 9/IT 5 ²⁾		For transmission shafts, h 10/IT 7 ²⁾ may be applied.		

[Notes] 1) Light, normal, and heavy loads refer to those with dynamic equivalent radial loads (P_r) of 5 % or lower, over 5 % up to 10 % inclusive, and over 10 % respectively in relation to the basic dynamic radial load rating (C_r) of the bearing concerned.
2) IT 5 and IT 7 mean that shaft roundness tolerance, cylindricity tolerance, and other errors in terms of shape should be within the tolerance range of IT 5 and IT 7, respectively. For numerical values for standard tolerance grades IT 5 and IT 7, refer to supplementary table at end of this catalog.

[Remark] This table is applicable to solid steel shafts.

Table 9-4 (2) Recommended housing fits for radial bearings (classes 0, 6X, 6)

Conditions			Class of housing bore tolerance range	Remarks	Applications (for reference)
Housing	Load type etc. ¹⁾	Outer ring axial displacement ²⁾			
One-piece or split type	All load types	Easily displaceable	H 7	G 7 may be applied when a large size bearing is used, or if the temperature difference is large between the outer ring and housing.	Ordinary bearing devices, railway rolling stock axle boxes, power transmission equipment etc.
			H 8	–	
	Stationary outer ring load	High temperature at shaft and inner ring		G 7	F 7 may be applied when a large size bearing is used, or if the temperature difference is large between the outer ring and housing.
One-piece type	Light or normal load, requiring high running accuracy	Not displaceable in principle	K 6	Mainly applied to roller bearings.	
		Displaceable	JS 6	Mainly applied to ball bearings.	
	Requiring low-noise rotation	Easily displaceable	H 6	–	
		Indeterminate direction load	Light or normal load	Normally displaceable	JS 7
	Normal or heavy load		Not displaceable in principle	K 7	
	Rotating outer ring load	High impact load	Not displaceable	M 7	–
Light or fluctuating load			Not displaceable	M 7	–
		Normal or heavy load		N 7	Mainly applied to ball bearings.
Thin section housing, heavy or high impact load			P 7	Mainly applied to roller bearings.	Wheel hubs with roller bearings, bearings for large end of connecting rods etc.

[Notes] 1) Loads are classified as stated in Note 1) to Table 9-4 (1).

2) Indicating distinction between applications of non-separable bearings permitting and not permitting axial displacement of the outer rings.

[Remarks] 1. This table is applicable to cast iron or steel housings.

2. If only central axial load is applied to the bearing, select such tolerance range class as to provide clearance in the radial direction for outer ring.

Table 9-5 (1) Recommended shaft fits for precision extra-small/miniature ball bearings ($d < 10$ mm)

Unit : μ m

Load type	Bearing tolerance class	Single plane mean bore diameter deviation Δ_{dmp}		Shaft diameter dimensional tolerance		Fit ¹⁾	Applications
		upper	lower	upper	lower		
Rotating inner ring load	Middle/high speed Light or normal load	ABMA 5P JIS class 5	0 0	-5.1 -5	+2.5 -2.5	7.6T - 2.5L 7.5T - 2.5L	Gyro rotors, air cleaners, electric tools, encoders
		ABMA 7P JIS class 4	0 0	-5.1 -4	+2.5 -2.5	7.6T - 2.5L 6.5T - 2.5L	
	Low speed Light load	ABMA 5P JIS class 5	0 0	-5.1 -5	-2.5 -7.5	2.6T - 7.5L 2.5T - 7.5L	Gyro gimbals, synchronizers, servomotors, floppy disc spindles
		ABMA 7P JIS class 4	0 0	-5.1 -4	-2.5 -7.5	2.6T - 7.5L 1.5T - 7.5L	
Rotating outer ring load	Low to high speed Light load	ABMA 5P JIS class 5	0 0	-5.1 -5	-2.5 -7.5	2.6T - 7.5L 2.5T - 7.5L	Pinch rolls, tape guide rollers, linear actuators
		ABMA 7P JIS class 4	0 0	-5.1 -4	-2.5 -7.5	2.6T - 7.5L 1.5T - 7.5L	

[Note] 1) Symbols T and L means interference and clearance respectively.

Table 9-5 (2) Recommended housing fits for precision extra-small/miniature ball bearings ($D \leq 30$ mm)

Unit : μ m

Load type	Bearing tolerance class	Single plane mean outside diameter deviation Δ_{Dmp}		Housing bore diameter dimensional tolerance		Fit ¹⁾	Applications
		upper	lower	upper	lower		
Rotating inner ring load	Middle/high speed Light or normal load	ABMA 5P ABMA 7P	0 0	-5.1 -6	+5 0	0 - 10.1L	Gyro rotors, air cleaners, electric tools, encoders
		JIS class 5 ²⁾	0 0	-5 -6	+5 0	0 - 10 L 0 - 11 L	
		JIS class 4 ²⁾	0 0	-4 -5	+5 0	0 - 9 L 0 - 10 L	
	Low speed Light load	ABMA 5P ABMA 7P	0 0	-5.1 -6	+2.5 -2.5	2.5T - 7.6L	Gyro gimbals, synchronizers, servomotors, floppy disc spindles
		JIS class 5 ²⁾	0 0	-5 -6	+2.5 -2.5	2.5T - 7.5L 2.5T - 8.5L	
		JIS class 4 ²⁾	0 0	-4 -5	+2.5 -2.5	2.5T - 6.5L 2.5T - 7.5L	
Rotating outer ring load	Low to high speed Light load	ABMA 5P ABMA 7P	0 0	-5.1 -6	+2.5 -2.5	2.5T - 7.6L	Pinch rolls, tape guide rollers
		JIS class 5 ²⁾	0 0	-5 -6	+2.5 -2.5	2.5T - 7.5L 2.5T - 8.5L	
		JIS class 4 ²⁾	0 0	-4 -5	+2.5 -2.5	2.5T - 6.5L 2.5T - 7.5L	

[Notes] 1) Symbols T and L means interference and clearance respectively.

2) In the columns "single plane mean outside diameter deviation" and "fit" upper row values are applied in the case of $D \leq 18$ mm, lower row values in the case of $18 < D \leq 30$ mm.

Table 9-6 (1) Recommended shaft fits for metric J series tapered roller bearings

■ Bearing tolerance : class PK, class PN

Load type		Nominal bore diameter <i>d</i> mm		Class of shaft tolerance range	Remarks
		over	up to		
Rotating inner ring load	Normal load	10	120	m 6	Generally, bearing internal clearance should be larger than standard.
		120	500	n 6	
	Heavy load Impact load High speed rotation	10	120	n 6	
		120	180	p 6	
		180	250	r 6	
		250	500	r 7	
Rotating outer ring load	Normal load without impact	80	315	h 6 or g 6	Generally, bearing internal clearance should be larger than standard.
		10	120	n 6	
	Heavy load Impact load High speed rotation	120	180	p 6	
		180	250	r 6	
		250	500	r 7	

■ Bearing tolerance : class PC, class PB

Load type		Nominal bore diameter <i>d</i> mm		Class of shaft tolerance range		Remarks
				(bearing tolerance class)		
		over	up to	PC	PB	
Rotating inner ring load	Spindles of precision machine tools	10	315	k 5	k 5	Generally, bearing internal clearance should be larger than standard.
		315	500	k 5	-	
	Heavy load Impact load High speed rotation	10	18	m 6	m 5	
		18	50	m 5	m 5	
		50	80	n 5	n 5	
		80	120	n 5	n 4	
		120	180	p 4	p 4	
		180	250	r 4	r 4	
		250	315	r 5	r 4	
		315	500	r 5	-	
Rotating outer ring load	Spindles of precision machine tools	10	315	k 5	k 5	
		315	500	k 5	-	

Table 9-6 (2) Recommended housing fits for metric J series tapered roller bearings

■ Bearing tolerance : class PK, class PN

Load type		Nominal outside diameter <i>D</i> mm		Class of housing bore diameter tolerance range	Remarks
		over	up to		
Rotating inner ring load	Used for free or fixed side	18	315	G 7 F 6	Outer ring is easily displaceable in axial direction.
	Position of outer ring is adjustable (in axial direction)	18	400	J 7	Outer ring is displaceable in axial direction.
		Position of outer ring is not adjustable (in axial direction)	18	400	P 7
Rotating outer ring load	Position of outer ring is not adjustable (in axial direction)	18	120 120 180 180 400	R 7	Outer ring is fixed in axial direction.

■ Bearing tolerance : class PC, class PB

Load type		Nominal outside diameter <i>D</i> mm		Class of housing bore diameter tolerance range		Remarks
				(bearing tolerance class)		
		over	up to	PC	PB	
Rotating inner ring load	Used for free side	18	315	G 5	G 5	Outer ring is easily displaceable in axial direction.
		315	500	G 5	-	
	Position of outer ring is adjustable (in axial direction)	18	315	H 5	H 4	Outer ring is displaceable in axial direction.
		315	500	H 5	-	
		18	120	K 5	K 5	
Position of outer ring is not adjustable (in axial direction)	120	180	JS 6	JS 6	Outer ring is fixed in axial direction.	
	180	250	JS 6	JS 5		
Rotating outer ring load	Position of outer ring is not adjustable (in axial direction)	250	315	K 5	JS 5	Outer ring is fixed in axial direction.
		315	500	K 5	-	
Rotating outer ring load	Position of outer ring is not adjustable (in axial direction)	18	315	N 5	M 5	Outer ring is fixed in axial direction.
		315	500	N 5	-	
		18	250	N 6	N 5	
		250	315	N 5	N 5	
		315	500	N 5	-	

Table 9-7 (1) Recommended shaft fits for inch series tapered roller bearings

■ Bearing tolerance : class 4, class 2

Load type	Nominal bore diameter <i>d</i> mm (1/25.4)		Deviation of a single bore diameter Δ_{ds} , μm		Dimensional tolerance of shaft diameter μm		Remarks		
	over	up to	upper	lower	upper	lower			
	Rotating inner ring load	Normal load	-	76.2 (3.0)	+13	0		+ 38	+ 25
76.2 (3.0)			304.8 (12.0)	+25	0	+ 64	+ 38		
304.8 (12.0)			609.6 (24.0)	+51	0	+127	+ 76		
609.6 (24.0)			914.4 (36.0)	+76	0	+190	+114		
Heavy load Impact load High speed rotation		-	76.2 (3.0)	+13	0	Should be such that average interference stands at 0.000 5 × <i>d</i> (mm)			
		76.2 (3.0)	304.8 (12.0)	+25	0				
Rotating outer ring load	Normal load without impact	-	76.2 (3.0)	+13	0	+ 13	0		
		76.2 (3.0)	304.8 (12.0)	+25	0	+ 25	0		
		304.8 (12.0)	609.6 (24.0)	+51	0	+ 51	0		
		609.6 (24.0)	914.4 (36.0)	+76	0	+ 76	0		
	Normal load without impact	-	76.2 (3.0)	+13	0	0	- 13	Inner ring is displaceable in axial direction.	
		76.2 (3.0)	304.8 (12.0)	+25	0	0	- 25		
		304.8 (12.0)	609.6 (24.0)	+51	0	0	- 51		
		609.6 (24.0)	914.4 (36.0)	+76	0	0	- 76		
	Heavy load Impact load High speed rotation	-	76.2 (3.0)	+13	0	Should be such that average interference stands at 0.000 5 × <i>d</i> (mm)		Generally, bearing internal clearance should be larger than standard.	
		76.2 (3.0)	304.8 (12.0)	+25	0				
		304.8 (12.0)	609.6 (24.0)	+51	0				
		609.6 (24.0)	914.4 (36.0)	+76	0				

■ Bearing tolerance : class 3, class 0¹⁾

Load type	Nominal bore diameter <i>d</i> mm (1/25.4)		Deviation of a single bore diameter Δ_{ds} , μm		Dimensional tolerance of shaft diameter μm		Remarks		
	over	up to	upper	lower	upper	lower			
	Rotating inner ring load	Spindles of precision machine tools	-	76.2 (3.0)	+13	0		+ 30	+ 18
76.2 (3.0)			304.8 (12.0)	+13	0	+ 30	+ 18		
304.8 (12.0)			609.6 (24.0)	+25	0	+ 64	+ 38		
609.6 (24.0)			914.4 (36.0)	+38	0	+102	+ 64		
Heavy load Impact load High speed rotation		-	76.2 (3.0)	+13	0	Should be such that average interference stands at 0.000 5 × <i>d</i> (mm)			
		76.2 (3.0)	304.8 (12.0)	+13	0				
Rotating outer ring load	Spindles of precision machine tools	-	76.2 (3.0)	+13	0	+ 30	+ 18		
		76.2 (3.0)	304.8 (12.0)	+13	0	+ 30	+ 18		
		304.8 (12.0)	609.6 (24.0)	+25	0	+ 64	+ 38		
		609.6 (24.0)	914.4 (36.0)	+38	0	+102	+ 64		

[Note] 1) Class 0 bearing : $d \leq 304.8$ mm

Table 9-7 (2) Recommended housing fits for inch series tapered roller bearings

■ Bearing tolerance : class 4, class 2

Load type	Nominal outside diameter <i>D</i> mm (1/25.4)		Deviation of a single outside diameter Δ_{Ds} , μm		Dimensional tolerance of housing bore diameter μm		Remarks		
	over	up to	upper	lower	upper	lower			
	Rotating inner ring load	Used for free or fixed side.	-	76.2 (3.0)	+ 25	0		+ 76	+ 51
76.2 (3.0)			127.0 (5.0)	+ 25	0	+ 76	+ 51		
127.0 (5.0)			304.8 (12.0)	+ 25	0	+ 76	+ 51		
304.8 (12.0)			609.6 (24.0)	+ 51	0	+152	+102		
Position of outer ring is adjustable (in axial direction).		-	76.2 (3.0)	+ 25	0	+ 25	0	Outer ring is displaceable in axial direction.	
		76.2 (3.0)	127.0 (5.0)	+ 25	0	+ 25	0		
Rotating outer ring load	Position of outer ring is not adjustable (in axial direction).	-	76.2 (3.0)	+ 25	0	- 13	- 38	Outer ring is fixed in axial direction.	
		76.2 (3.0)	127.0 (5.0)	+ 25	0	- 25	- 51		
		127.0 (5.0)	304.8 (12.0)	+ 25	0	- 25	- 51		
		304.8 (12.0)	609.6 (24.0)	+ 51	0	- 25	- 76		
	Position of outer ring is not adjustable (in axial direction).	-	76.2 (3.0)	+ 25	0	- 13	- 38	Outer ring is fixed in axial direction.	
		76.2 (3.0)	127.0 (5.0)	+ 25	0	- 25	- 51		
		127.0 (5.0)	304.8 (12.0)	+ 25	0	- 25	- 51		
		304.8 (12.0)	609.6 (24.0)	+ 51	0	- 25	- 76		
	Position of outer ring is not adjustable (in axial direction).	-	76.2 (3.0)	+ 25	0	- 13	- 38	Outer ring is fixed in axial direction.	
		76.2 (3.0)	127.0 (5.0)	+ 25	0	- 25	- 51		
		127.0 (5.0)	304.8 (12.0)	+ 25	0	- 25	- 51		
		304.8 (12.0)	609.6 (24.0)	+ 51	0	- 25	- 76		

■ Bearing tolerance : class 3, class 0¹⁾

Load type	Nominal outside diameter <i>D</i> mm (1/25.4)		Deviation of a single outside diameter Δ_{Ds} , μm		Dimensional tolerance of housing bore diameter μm		Remarks	
	over	up to	upper	lower	upper	lower		
	Rotating inner ring load	Used for free side.	-	152.4 (6.0)	+ 13	0		+ 38
152.4 (6.0)			304.8 (12.0)	+ 13	0	+ 38	+ 25	
304.8 (12.0)			609.6 (24.0)	+ 25	0	+ 64	+ 38	
609.6 (24.0)			914.4 (36.0)	+ 38	0	+ 89	+ 51	
Used for fixed side.		-	152.4 (6.0)	+ 13	0	+ 25	+ 13	Outer ring is displaceable in axial direction.
		152.4 (6.0)	304.8 (12.0)	+ 13	0	+ 25	+ 13	
Position of outer ring is adjustable (in axial direction).	-	152.4 (6.0)	+ 13	0	+ 13	0	Outer ring is fixed in axial direction.	
	152.4 (6.0)	304.8 (12.0)	+ 13	0	+ 25	0		
	304.8 (12.0)	609.6 (24.0)	+ 25	0	+ 25	0		
	609.6 (24.0)	914.4 (36.0)	+ 38	0	+ 38	0		
Position of outer ring is not adjustable (in axial direction).	-	152.4 (6.0)	+ 13	0	0	- 13	Outer ring is fixed in axial direction.	
	152.4 (6.0)	304.8 (12.0)	+ 13	0	0	- 25		
	304.8 (12.0)	609.6 (24.0)	+ 25	0	0	- 25		
	609.6 (24.0)	914.4 (36.0)	+ 38	0	0	- 38		
Rotating outer ring load	Position of outer ring is not adjustable (in axial direction).	-	152.4 (6.0)	+ 13	0	- 13	- 25	Outer ring is fixed in axial direction.
		152.4 (6.0)	304.8 (12.0)	+ 13	0	- 13	- 38	
		304.8 (12.0)	609.6 (24.0)	+ 25	0	- 13	- 38	
		609.6 (24.0)	914.4 (36.0)	+ 38	0	- 13	- 51	

[Note] 1) Class 0 bearing : $D \leq 304.8$ mm

Table 9-8 (1) Recommended shaft fits for thrust bearings (classes 0, 6)

Load type	Shaft diameter, mm		Class of shaft tolerance range	Remarks	
	over	up to			
Central axial load (generally for thrust bearings)	All shaft diameters		js 6	h 6 may also be used.	
Combined load (spherical thrust roller bearing)	Stationary shaft race load	All shaft diameters		js 6	
	Rotating shaft race load or indeterminate direction load	–	200	k 6	js 6, k 6 and m 6 may be used in place of k 6, m 6 and n 6, respectively.
		200	400	m 6	
400	–	n 6			

Table 9-8 (2) Recommended housing fits for thrust bearings (classes 0, 6)

Load type	Class of housing bore diameter tolerance range	Remarks	
Central axial load (generally for thrust bearings)	–	Select such tolerance range class as provides clearance in the radial direction for housing race.	
	H 8	In case of thrust ball bearings requiring high accuracy.	
Combined load (spherical thrust roller bearing)	Stationary housing race load	H 7	
	Indeterminate direction load or rotating housing race load	K 7	In case of application under normal operating conditions.
		M 7	In case of comparably large radial load.

[Remark] This table is applicable to cast iron or steel housings.

10. Bearing internal clearance

Bearing internal clearance is defined as the total distance either inner or outer ring can be moved when the other ring is fixed.

If movement is in the radial direction, it is called radial internal clearance; if in the axial direction, axial internal clearance. (Fig. 10-1)

Bearing performance depends greatly upon internal clearance during operation (also referred to as operating clearance); inappropriate clearance results in short rolling fatigue life and generation of heat, noise or vibration.

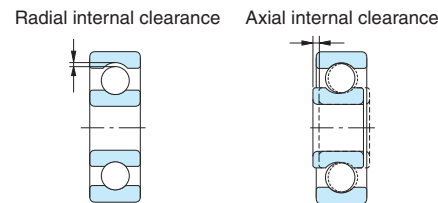

Fig. 10-1 Bearing internal clearance

In measuring internal clearance, a specified load is generally applied in order to obtain stable measurement values.

Consequently, measured clearance values will be larger than the original clearance by the amount of elastic deformation due to the load applied for measurement.

As far as roller bearings are concerned, however, the amount of elastic deformation is negligible.

Clearance prior to mounting is generally defined as the original clearance.

10-1 Selection of internal clearance

The term "residual clearance" is defined as the original clearance decreased owing to expansion or contraction of a raceway due to fitting, when the bearing is mounted in the shaft and housing.

The term "effective clearance" is defined as the residual clearance decreased owing to dimensional change arising from temperature differentials within the bearing.

The term "operating clearance" is defined as the internal clearance present while a bearing mounted in a machine is rotating under a certain load, or, the effective clearance increased due to elastic deformation arising from bearing loads.

As illustrated in Fig. 10-2, bearing fatigue life is longest when the operating clearance is slightly negative.

However, as the operating clearance becomes more negative, the fatigue life shortens remarkably.

Thus it is recommended that bearing internal clearance be selected such that the operating clearance is slightly positive.

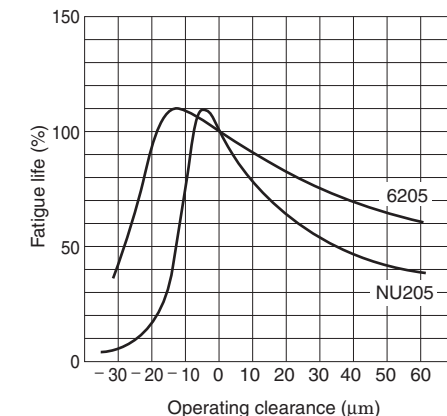

Fig. 10-2 Relationship between operating clearance and fatigue life

It is important to take specific operating conditions into consideration and select a clearance suitable for the conditions.

For example, when high rigidity is required, or when the noise must be minimized, the operating clearance must be reduced. On the other hand, when high operating temperature is expected, the operating clearance must be increased.

10-2 Operating clearance

Table 10-1 shows how to determine the operating clearance when the shaft and housing are made of steel.

Tables 10-2 to 10-10 show standard values for bearing internal clearance before mounting.

Table 10-11 shows examples of clearance selection excluding CN clearance.

Table 10-1 How to determine operating clearance

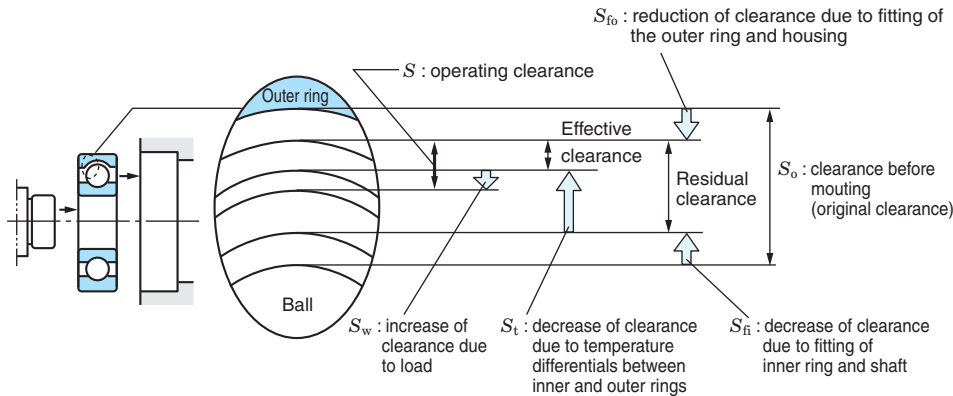

Operating clearance (S)	$S = S_0 - (S_f + S_{t1} + S_{t2}) + S_w^*$ <p>* S_w (increase of clearance due to load) is generally small, and thus may be ignored, although there is an equation for determining the value.</p>	
Decrease of clearance due to fitting (S_f)	(In the case of hollow shaft) $S_f = \Delta_{Deff} \frac{d}{D_i} \cdot \left(1 - \frac{d_0^2}{d^2}\right)$ (In the case of solid shaft) $S_f = \Delta_{Deff} \frac{d}{D_i}$	(In the case of $D_h \neq \infty$) $S_{fi} = \Delta_{Deff} \frac{D_e}{D} \cdot \left(1 - \frac{D^2}{D_h^2}\right)$ (In the case of $D_h = \infty$) $S_{fi} = \Delta_{Deff} \frac{D_e}{D}$
Decrease of clearance due to temperature differentials between inner and outer rings (S_{t1})	The amount of decrease varies depending on the state of housing; however, generally the amount can be approximated by the following equation on the assumption that the outer ring will not expand: $S_{t1} = \alpha (D_i \cdot t_i - D_e \cdot t_e)$	
Decrease of clearance due to temperature rise of rolling element (S_{t2})	where : $D_e = D_i + 2D_w$ Consequently, $S_{t1} + S_{t2}$ will be determined by the following equation : $S_{t1} + S_{t2} = \alpha \cdot D_i \cdot t_1 + 2 \alpha \cdot D_w \cdot t_2$ Temperature differential between the inner and outer rings, t_1 , can be expressed as follows : $t_1 = t_i - t_e$ Temperature differential between the rolling element and outer ring, t_2 , can be expressed as follows : $t_2 = t_w - t_e$	

In Table 10-1,

S : operating clearance	mm	Δ_{Deff} : effective interference of outer ring	mm
S_0 : clearance before mounting	mm	D_h : outside diameter of housing	mm
S_f : decrease of clearance due to fitting	mm	D_e : outer ring raceway contact diameter	mm
S_{fi} : expansion of inner ring raceway contact diameter	mm	(ball bearing $D_e \cong 0.2(4D + d)$	mm
S_{fo} : contraction of outer ring raceway contact diameter	mm	(roller bearing ... $D_e \cong 0.25(3D + d)$)	
S_{t1} : decrease of clearance due to temperature differentials between inner and outer rings	mm	D : nominal outside diameter	mm
S_{t2} : decrease of clearance due to temperature rise of the rolling elements	mm	α : linear expansion coefficient of bearing steel (12.5×10^{-6})	1/°C
S_w : increase of clearance due to load	mm	D_w : average diameter of rolling elements	mm
Δ_{deff} : effective interference of inner ring	mm	(ball bearing $D_w \cong 0.3(D - d)$	mm
d : nominal bore diameter (shaft diameter)	mm	(roller bearing ... $D_w \cong 0.25(D - d)$)	
d_0 : bore diameter of hollow shaft	mm	t_i : temperature rise of the inner ring	°C
D_i : inner ring raceway contact diameter	mm	t_e : temperature rise of the outer ring	°C
(ball bearing $D_i \cong 0.2(D + 4d)$	mm	t_w : temperature rise of rolling elements	°C
(roller bearing ... $D_i \cong 0.25(D + 3d)$)			

- Bearings are sometimes used with a non-steel shaft or housing. In the automotive industry, a statistical method is often incorporated for selection of clearance. In these cases, or when other special operating conditions are involved, JTEKT should be consulted.

Table 10-2 Radial internal clearance of deep groove ball bearings (cylindrical bore)

Unit : μm

Nominal bore diameter <i>d</i> , mm		Clearance									
		C 2		C N		C 3		C 4		C 5	
over	up to	min.	max.	min.	max.	min.	max.	min.	max.	min.	max.
2.5	6	0	7	2	13	8	23	<i>14</i>	<i>29</i>	20	37
6	10	0	7	2	13	8	23	14	29	20	37
10	18	0	9	3	18	11	25	18	33	25	45
18	24	0	10	5	20	13	28	20	36	28	48
24	30	1	11	5	20	13	28	23	41	30	53
30	40	1	11	6	20	15	33	28	46	40	64
40	50	1	11	6	23	18	36	30	51	45	73
50	65	1	15	8	28	23	43	38	61	55	90
65	80	1	15	10	30	25	51	46	71	65	105
80	100	1	18	12	36	30	58	53	84	75	120
100	120	2	20	15	41	36	66	61	97	90	140
120	140	2	23	18	48	41	81	71	114	105	160
140	160	2	23	18	53	46	91	81	130	120	180
160	180	2	25	20	61	53	102	91	147	135	200
180	200	2	30	25	71	63	117	107	163	150	230
200	225	2	35	25	85	75	140	125	195	175	265
225	250	2	40	30	95	85	160	145	225	205	300
250	280	2	45	35	105	90	170	155	245	225	340
280	315	2	55	40	115	100	190	175	270	245	370
315	355	3	60	45	125	110	210	195	300	275	410
355	400	3	70	55	145	130	240	225	340	315	460

[Remarks] 1. For measured clearance, the increase of radial internal clearance caused by the measurement load should be added to the values in the above table for correction. Amounts for correction are as shown below.
Of the amounts for clearance correction in the C 2 column, the smaller is applied to the minimum clearance, the larger to the maximum clearance.
2. Values in Italics are prescribed in JTEKT standards.

Nominal bore diameter <i>d</i> , mm		Measurement load N	Amounts of clearance correction, μm				
			C 2	C N	C 3	C 4	C 5
over	up to						
2.5	18	24.5	3 - 4	4	4	4	4
18	50	49	4 - 5	5	6	6	6
50	280	147	6 - 8	8	9	9	9

Table 10-3 Radial internal clearance of extra-small/miniature ball bearings Unit : μm

Clearance code	M 1		M 2		M 3		M 4		M 5		M 6	
	min.	max.	min.	max.	min.	max.	min.	max.	min.	max.	min.	max.
Clearance	0	5	3	8	5	10	8	13	13	20	20	28

[Remark] For measured clearance, the following amounts should be added for correction.

Measurement load, N		Amounts of clearance correction, μm					
Extra-small ball bearing	Miniature ball bearing	M1	M2	M3	M4	M5	M6
2.3		1	1	1	1	1	1

(Extra-small ball bearing : 9 mm or larger in outside diameter and under 10 mm in bore diameter)
(Miniature ball bearing : under 9 mm in outside diameter)

Table 10-4 Axial internal clearance of matched pair angular contact ball bearings (measurement clearance)¹⁾

Unit : μm

Nominal bore diameter <i>d</i> , mm		Contact angle : 15°				Contact angle : 30°							
		C 2		C N		C 2		C N		C 3		C 4	
over	up to	min.	max.	min.	max.	min.	max.	min.	max.	min.	max.	min.	max.
-	10	13	33	33	53	3	14	10	30	30	50	50	70
10	18	15	35	35	55	3	16	10	30	30	50	50	70
18	24	20	40	45	65	3	20	20	40	40	60	60	80
24	30	20	40	45	65	3	20	20	40	40	60	60	80
30	40	20	40	45	65	3	20	25	45	45	65	70	90
40	50	20	40	50	70	3	20	30	50	50	70	75	95
50	65	30	55	65	90	9	27	35	60	60	85	90	115
65	80	30	55	70	95	10	28	40	65	70	95	110	135
80	100	35	60	85	110	10	30	50	75	80	105	130	155
100	120	40	65	100	125	12	37	65	90	100	125	150	175
120	140	45	75	110	140	15	40	75	105	120	150	180	210
140	160	45	75	125	155	15	40	80	110	130	160	210	240
160	180	50	80	140	170	15	45	95	125	140	170	235	265
180	200	50	80	160	190	20	50	110	140	170	200	275	305

Nominal bore diameter <i>d</i> , mm		Contact angle : 40°							
		C 2		C N		C 3		C 4	
over	up to	min.	max.	min.	max.	min.	max.	min.	max.
-	10	2	10	6	18	16	30	26	40
10	18	2	12	7	21	18	32	28	44
18	24	2	12	12	26	20	40	30	50
24	30	2	14	12	26	20	40	40	60
30	40	2	14	12	26	25	45	45	65
40	50	2	14	12	30	30	50	50	70
50	65	5	17	17	35	35	60	60	85
65	80	6	18	18	40	40	65	70	95
80	100	6	20	20	45	55	80	85	110
100	120	6	25	25	50	60	85	100	125
120	140	7	30	30	60	75	105	125	155
140	160	7	30	35	65	85	115	140	170
160	180	7	31	45	75	100	130	155	185
180	200	7	37	60	90	110	140	170	200

[Note] 1) Including increase of clearance caused by measurement load.

Table 10-5 Radial internal clearance of double-row angular contact ball bearings

Unit : μm

Nominal bore diameter <i>d</i> , mm		Clearance					
		CD2		CDN		CD3	
over	up to	min.	max.	min.	max.	min.	max.
2.5	10	0	7	2	10	8	18
10	18	0	7	2	11	9	19
18	24	0	8	2	11	10	21
24	30	0	8	2	13	10	23
30	40	0	9	3	14	11	24
40	50	0	10	4	16	13	27
50	65	0	11	6	20	15	30
65	80	0	12	7	22	18	33
80	100	0	12	8	24	22	38
100	120	0	13	9	25	24	42
120	140	0	15	10	26	25	44
140	160	0	16	11	28	26	46
160	180	0	17	12	30	27	47
180	200	0	18	14	32	28	48

[Remark]
Regarding deep groove ball bearings and matched pair and double-row angular contact ball bearings, equations of the relationship between radial internal clearance and axial internal clearance are shown on page A 111.

Table 10-6 Radial internal clearance of self-aligning ball bearings

Unit : μm

Nominal bore diameter <i>d</i> , mm		Cylindrical bore bearing clearance										Tapered bore bearing clearance									
		C 2		C N		C 3		C 4		C 5		C 2		C N		C 3		C 4		C 5	
over	up to	min.	max.	min.	max.	min.	max.	min.	max.	min.	max.	min.	max.	min.	max.	min.	max.	min.	max.	min.	max.
2.5	6	1	8	5	15	10	20	15	25	21	33	-	-	-	-	-	-	-	-	-	-
6	10	2	9	6	17	12	25	19	33	27	42	-	-	-	-	-	-	-	-	-	-
10	14	2	10	6	19	13	26	21	35	30	48	-	-	-	-	-	-	-	-	-	-
14	18	3	12	8	21	15	28	23	37	32	50	-	-	-	-	-	-	-	-	-	-
18	24	4	14	10	23	17	30	25	39	34	52	7	17	13	26	20	33	28	42	37	55
24	30	5	16	11	24	19	35	29	46	40	58	9	20	15	28	23	39	33	50	44	62
30	40	6	18	13	29	23	40	34	53	46	66	12	24	19	35	29	46	40	59	52	72
40	50	6	19	14	31	25	44	37	57	50	71	14	27	22	39	33	52	45	65	58	79
50	65	7	21	16	36	30	50	45	69	62	88	18	32	27	47	41	61	56	80	73	99
65	80	8	24	18	40	35	60	54	83	76	108	23	39	35	57	50	75	69	98	91	123
80	100	9	27	22	48	42	70	64	96	89	124	29	47	42	68	62	90	84	116	109	144
100	120	10	31	25	56	50	83	75	114	105	145	35	56	50	81	75	108	100	139	130	170
120	140	10	38	30	68	60	100	90	135	125	175	40	68	60	98	90	130	120	165	155	205
140	160	15	44	35	80	70	120	110	161	150	210	45	74	65	110	100	150	140	191	180	240

Table 10-7 Radial internal clearance of electric motor bearings

1) Deep groove ball bearing Unit : μm

Nominal bore diameter <i>d</i> , mm		Clearance	
		CM	
over	up to	min.	max.
10 ¹⁾	18	4	11
18	30	5	12
30	50	9	17
50	80	12	22
80	120	18	30
120	160	24	38

[Note] 1) 10 mm is included.
[Remark] To adjust for change of clearance due to measuring load, use correction values shown in Table 10-2.

2) Cylindrical roller bearing Unit : μm

Nominal bore diameter <i>d</i> , mm		Clearance			
		Interchangeability CT		Non-interchangeability CM	
over	up to	min.	max.	min.	max.
24	40	15	35	15	30
40	50	20	40	20	35
50	65	25	45	25	40
65	80	30	50	30	45
80	100	35	60	35	55
100	120	35	65	35	60
120	140	40	70	40	65
140	160	50	85	50	80
160	180	60	95	60	90
180	200	65	105	65	100

[Note] "Interchangeability" means interchangeable only among products (sub-units) of the same manufacturer ; not with others.

Table 10-8 Radial internal clearance of cylindrical roller bearings and machined ring needle roller bearings

(1) Cylindrical bore bearing

Unit : μm

Nominal bore diameter <i>d</i> , mm		Clearance									
		C 2		C N		C 3		C 4		C 5	
over	up to	min.	max.	min.	max.	min.	max.	min.	max.	min.	max.
–	10	0	25	20	45	35	60	50	75	–	–
10	24	0	25	20	45	35	60	50	75	65	90
24	30	0	25	20	45	35	60	50	75	70	95
30	40	5	30	25	50	45	70	60	85	80	105
40	50	5	35	30	60	50	80	70	100	95	125
50	65	10	40	40	70	60	90	80	110	110	140
65	80	10	45	40	75	65	100	90	125	130	165
80	100	15	50	50	85	75	110	105	140	155	190
100	120	15	55	50	90	85	125	125	165	180	220
120	140	15	60	60	105	100	145	145	190	200	245
140	160	20	70	70	120	115	165	165	215	225	275
160	180	25	75	75	125	120	170	170	220	250	300
180	200	35	90	90	145	140	195	195	250	275	330
200	225	45	105	105	165	160	220	220	280	305	365
225	250	45	110	110	175	170	235	235	300	330	395
250	280	55	125	125	195	190	260	260	330	370	440
280	315	55	130	130	205	200	275	275	350	410	485
315	355	65	145	145	225	225	305	305	385	455	535
355	400	100	190	190	280	280	370	370	460	510	600
400	450	110	210	210	310	310	410	410	510	565	665
450	500	110	220	220	330	330	440	440	550	625	735

(2) Tapered bore bearing

Unit : μm

Nominal bore diameter <i>d</i> , mm		Non-interchangeable clearance													
		C 9 NA ¹⁾		C 1 NA		C 2 NA		C N NA		C 3 NA		C 4 NA		C 5 NA	
over	up to	min.	max.	min.	max.	min.	max.	min.	max.	min.	max.	min.	max.	min.	max.
12	14	5	10	–	–	–	–	–	–	–	–	–	–	–	–
14	24	5	10	10	20	20	30	35	45	45	55	55	65	75	85
24	30	5	10	10	25	25	35	40	50	50	60	60	70	80	95
30	40	5	12	12	25	25	40	45	55	55	70	70	80	95	110
40	50	5	15	15	30	30	45	50	65	65	80	80	95	110	125
50	65	5	15	15	35	35	50	55	75	75	90	90	110	130	150
65	80	10	20	20	40	40	60	70	90	90	110	110	130	150	170
80	100	10	25	25	45	45	70	80	105	105	125	125	150	180	205
100	120	10	25	25	50	50	80	95	120	120	145	145	170	205	230
120	140	15	30	30	60	60	90	105	135	135	160	160	190	230	260
140	160	15	35	35	65	65	100	115	150	150	180	180	215	260	295
160	180	15	35	35	75	75	110	125	165	165	200	200	240	285	320
180	200	20	40	40	80	80	120	140	180	180	220	220	260	315	355
200	225	20	45	45	90	90	135	155	200	200	240	240	285	350	395
225	250	25	50	50	100	100	150	170	215	215	265	265	315	380	430
250	280	25	55	55	110	110	165	185	240	240	295	295	350	420	475
280	315	30	60	60	120	120	180	205	265	265	325	325	385	470	530
315	355	30	65	65	135	135	200	225	295	295	360	360	430	520	585
355	400	35	75	75	150	150	225	255	330	330	405	405	480	585	660
400	450	45	85	85	170	170	255	285	370	370	455	455	540	650	735
450	500	50	95	95	190	190	285	315	410	410	505	505	600	720	815

[Note] 1) Clearance C 9 NA is applied to tapered bore cylindrical roller bearings of JIS tolerance classes 5 and 4.

Table 10-9 Radial internal clearance of spherical roller bearings

(1) Cylindrical bore bearing

Unit : μm

Nominal bore diameter d , mm		Clearance									
		C 2		C N		C 3		C 4		C 5	
over	up to	min.	max.	min.	max.	min.	max.	min.	max.	min.	max.
14	18	10	20	20	35	35	45	45	60	60	75
18	24	10	20	20	35	35	45	45	60	60	75
24	30	15	25	25	40	40	55	55	75	75	95
30	40	15	30	30	45	45	60	60	80	80	100
40	50	20	35	35	55	55	75	75	100	100	125
50	65	20	40	40	65	65	90	90	120	120	150
65	80	30	50	50	80	80	110	110	145	145	180
80	100	35	60	60	100	100	135	135	180	180	225
100	120	40	75	75	120	120	160	160	210	210	260
120	140	50	95	95	145	145	190	190	240	240	300
140	160	60	110	110	170	170	220	220	280	280	350
160	180	65	120	120	180	180	240	240	310	310	390
180	200	70	130	130	200	200	260	260	340	340	430
200	225	80	140	140	220	220	290	290	380	380	470
225	250	90	150	150	240	240	320	320	420	420	520
250	280	100	170	170	260	260	350	350	460	460	570
280	315	110	190	190	280	280	370	370	500	500	630
315	355	120	200	200	310	310	410	410	550	550	690
355	400	130	220	220	340	340	450	450	600	600	750
400	450	140	240	240	370	370	500	500	660	660	820
450	500	140	260	260	410	410	550	550	720	720	900
500	560	150	280	280	440	440	600	600	780	780	1 000
560	630	170	310	310	480	480	650	650	850	850	1 100
630	710	190	350	350	530	530	700	700	920	920	1 190
710	800	210	390	390	580	580	770	770	1 010	1 010	1 300
800	900	230	430	430	650	650	860	860	1 120	1 120	1 440
900	1 000	260	480	480	710	710	930	930	1 220	1 220	1 570

(2) Tapered bore bearing

Unit : μm

Nominal bore diameter d , mm		Clearance									
		C 2		C N		C 3		C 4		C 5	
over	up to	min.	max.	min.	max.	min.	max.	min.	max.	min.	max.
18	24	15	25	25	35	35	45	45	60	60	75
24	30	20	30	30	40	40	55	55	75	75	95
30	40	25	35	35	50	50	65	65	85	85	105
40	50	30	45	45	60	60	80	80	100	100	130
50	65	40	55	55	75	75	95	95	120	120	160
65	80	50	70	70	95	95	120	120	150	150	200
80	100	55	80	80	110	110	140	140	180	180	230
100	120	65	100	100	135	135	170	170	220	220	280
120	140	80	120	120	160	160	200	200	260	260	330
140	160	90	130	130	180	180	230	230	300	300	380
160	180	100	140	140	200	200	260	260	340	340	430
180	200	110	160	160	220	220	290	290	370	370	470
200	225	120	180	180	250	250	320	320	410	410	520
225	250	140	200	200	270	270	350	350	450	450	570
250	280	150	220	220	300	300	390	390	490	490	620
280	315	170	240	240	330	330	430	430	540	540	680
315	355	190	270	270	360	360	470	470	590	590	740
355	400	210	300	300	400	400	520	520	650	650	820
400	450	230	330	330	440	440	570	570	720	720	910
450	500	260	370	370	490	490	630	630	790	790	1 000
500	560	290	410	410	540	540	680	680	870	870	1 100
560	630	320	460	460	600	600	760	760	980	980	1 230
630	710	350	510	510	670	670	850	850	1 090	1 090	1 360
710	800	390	570	570	750	750	960	960	1 220	1 220	1 500
800	900	440	640	640	840	840	1 070	1 070	1 370	1 370	1 690
900	1 000	490	710	710	930	930	1 190	1 190	1 520	1 520	1 860

Table 10-10 Radial internal clearance of double/four-row and matched pair tapered roller bearings (cylindrical bore)

Unit : μm

Nominal bore diameter <i>d</i> , mm		Clearance									
		C 1		C 2		C N		C 3		C 4	
over	up to	min.	max.	min.	max.	min.	max.	min.	max.	min.	max.
14	18	0	10	10	20	20	30	30	40	40	50
18	24	0	10	10	20	20	30	30	40	40	55
24	30	0	10	10	20	20	30	30	45	45	60
30	40	0	12	12	25	25	40	40	55	55	75
40	50	0	15	15	30	30	45	45	60	60	80
50	65	0	15	15	30	30	50	50	70	70	90
65	80	0	20	20	40	40	60	60	80	80	110
80	100	0	20	20	45	45	70	70	100	100	130
100	120	0	25	25	50	50	80	80	110	110	150
120	140	0	30	30	60	60	90	90	120	120	170
140	160	0	30	30	65	65	100	100	140	140	190
160	180	0	35	35	70	70	110	110	150	150	210
180	200	0	40	40	80	80	120	120	170	170	230
200	225	0	40	40	90	90	140	140	190	190	260
225	250	0	50	50	100	100	150	150	210	210	290
250	280	0	50	50	110	110	170	170	230	230	320
280	315	0	60	60	120	120	180	180	250	250	350
315	355	0	70	70	140	140	210	210	280	280	390
355	400	0	70	70	150	150	230	230	310	310	440
400	450	0	80	80	170	170	260	260	350	350	490
450	500	0	90	90	190	190	290	290	390	390	540
500	560	0	100	100	210	210	320	320	430	430	590
560	630	0	110	110	230	230	350	350	480	480	660
630	710	0	130	130	260	260	400	400	540	540	740
710	800	0	140	140	290	290	450	450	610	610	830
800	900	0	160	160	330	330	500	500	670	670	920

Table 10-11 Examples of non-standard clearance selection

Service conditions	Applications	Examples of clearance selection
In the case of heavy/impact load, large interference	Railway rolling stock axle journals	C 3
In the case of vibration/impact load, interference fit both for inner/outer rings	Shaker screens, railway rolling stock traction motors, tractor final reduction gears	C 3, C 4 C 4 C 4
When shaft deflection is large	Automobile rear wheels	C 5
When shaft and inner ring are heated	Dryers of paper making machines, table rollers of rolling mills	C 3, C 4 C 3
When clearance fit both for inner/outer rings	Roll necks of rolling mills	C 2
When noise/vibration during rotation is to be lowered	Micro-motors	C 1, C 2, CM
When clearance after mounting is to be adjusted in order to reduce shaft runout	Lathe spindles	C 9 NA, C 1 NA

[Reference] Relationship between radial internal clearance and axial internal clearance

[Deep groove ball bearing] $\Delta_a = \sqrt{\Delta_r (4m_o - \Delta_r)}$ (10-1)

[Double-row angular contact ball bearing] $\Delta_a = 2\sqrt{m_o^2 - (m_o \cos \alpha - \frac{\Delta_r}{2})^2} - 2m_o \sin \alpha$ (10-2)

[Matched pair angular contact ball bearing] $\Delta_a = 2m_o \sin \alpha - 2\sqrt{m_o^2 - (m_o \cos \alpha + \frac{\Delta_r}{2})^2}$ (10-3)

[Double/four-row and matched pair tapered roller bearing] $\Delta_a = \Delta_r \cot \alpha \div \frac{1.5}{e} \Delta_r$ (10-4)

where :

Δ_a : axial internal clearance mm

Δ_r : radial internal clearance mm

$m_o = r_e + r_i - D_w$

r_e : outer ring raceway groove radius mm
 r_i : inner ring raceway groove radius mm
 D_w : ball diameter mm

α : nominal contact angle

e : limit value of F_a/F_r

(shown in the bearing specification table.)

11. Preload

Generally, bearings are operated with a certain amount of proper clearance allowed. For some applications, however, bearings are mounted with axial load of such magnitude that the clearance will be negative.

The axial load, referred to as "preload," is often applied to angular contact ball bearings and tapered roller bearings.

11-1 Purpose of preload

- To improve running accuracy by reducing runout of shaft, as well as to heighten position accuracy in radial and axial directions. (Bearings for machine tool spindles and measuring instruments)
- To improve gear engagement accuracy by increasing bearing rigidity. (Bearings for automobile final reduction gears)
- To reduce smearing by eliminating sliding in irregular rotation, self-rotation, and around-the-raceway revolution of rolling elements. (For high rotation-speed angular contact ball bearings)
- To minimize abnormal noise due to vibration or resonance. (For small electric motor bearings)
- To keep rolling elements in the right position relative to the raceway. (For thrust ball bearings and spherical thrust roller bearings used on horizontal shafts)

11-2 Method of preloading

The preload can be done either by the position preloading or the constant pressure preloading; typical examples are given in Table 11-1.

(Comparison between position and constant pressure preloadings)

- With the same amount of preloading, the position preloading produces smaller displacement in the axial direction, and thus is liable to bring about higher rigidity.
- The constant pressure preloading produces stable preloading, or little fluctuation in the amount of preload, since the spring can absorb the load fluctuation and shaft expansion/contraction caused by temperature difference between the shaft and housing during operation.
- The position preloading can apply a larger preload.

Consequently, the position preloading is more suitable for applications requiring high rigidity, while the constant pressure preloading is more suitable for high rotational speed, vibration prevention in the axial direction, and thrust bearings used on horizontal shafts.

11-3 Preload and rigidity

For angular contact ball bearings and tapered roller bearings, the "back-to-back" arrangement is generally used to apply preload for higher rigidity.

This is because shaft rigidity is improved by the longer distance between load centers in the back-to-back arrangement.

Fig. 11-1 shows the relationship between preload given via position preloading and rigidity expressed by displacement in the axial direction of the back-to-back bearing.

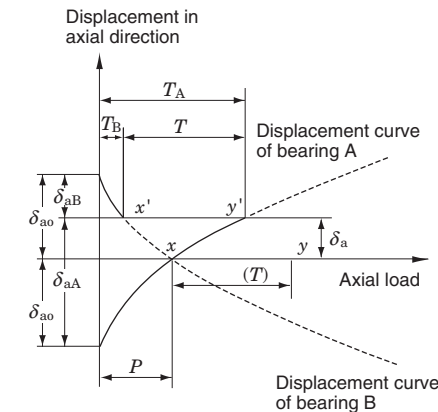
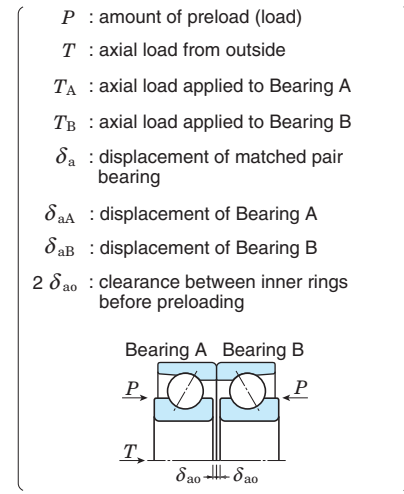

Fig. 11-1 Preloading diagram in position preloading

In Fig. 11-1, when preload P is applied (inner ring is tightened toward the axial direction), bearings A and B are displaced by δ_{a0} respectively, and the clearance between inner rings diminishes from $2\delta_{a0}$ to zero.

The displacement when axial load T is applied to these matched pair bearings from the outside can be determined as δ_a .

[For reference]

How to determine δ_a in Fig. 11-1

- ① Determine the displacement curve of bearing A.
- ② Determine the displacement curve of bearing B. ...Symmetrical curve in relation to horizontal axis intersecting vertical line of preload P at point x .
- ③ With the load from outside defined as T , determine line segment $x-y$ on the horizontal line passing through point x . Displace segment $x-y$ in parallel along the displacement curve of bearing B. Determine point y' at which to intersect displacement curve of bearing A.
- ④ δ_a can be determined as the distance between line segments $x'-y'$ and $x-y$.

Fig. 11-2 shows the relationship between preload and rigidity in the constant pressure preloading using the same matched pair bearings as in Fig. 11-1.

In this case, since the spring rigidity can be ignored, the matched pair bearing shows almost the same rigidity as a separate bearing with preload P applied in advance.

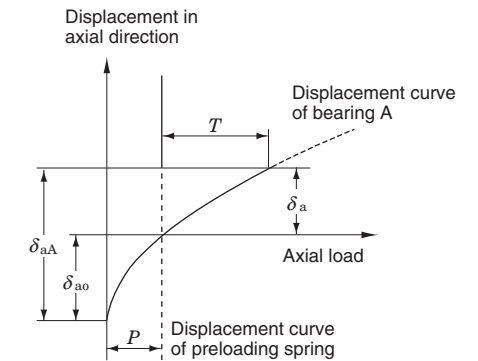

Fig. 11-2 Preloading diagram in constant pressure preloading

Table 11-1 Method of preloading

Position preloading		Constant pressure preloading	
<ul style="list-style-type: none"> ● Method using matched pair bearing with stand-out adjusted for preloading (see below). 	<ul style="list-style-type: none"> ● Method using spacer with dimensions adjusted for preloading. 	<ul style="list-style-type: none"> ● Method using nut or bolt capable of adjusting preload in axial direction. <p>(In this case, starting friction moment during adjustment should be measured so that proper preload will be applied.)</p>	<ul style="list-style-type: none"> ● Method using coil spring or diaphragm spring.

11-4 Amount of preload

The amount of preload should be determined, to avoid an adverse effect on bearing life, temperature rise, friction torque, or other performance characteristic, in view of the bearing application.

Decrease of preload due to wear-in, accuracy of the shaft and housing, mounting conditions, and lubrication should also be fully considered in determining preload.

11-4-1 Preload amount of matched pair angular contact ball bearings

Table 11-2 shows recommended preload for matched pair angular contact ball bearings of JIS class 5 or higher used for machine tool spindles or other higher precision applications.

JTEKT offers four types of standard preload: slight preload (S), light preload (L), medium preload (M), and heavy preload (H), so that preload can be selected properly and easily for various applications.

Generally, light or medium preload is recommended for grinder spindles, and medium or heavy preload for spindles of lathes and milling machines.

Table 11-3 shows recommended fits of high-precision matched pair angular contact ball bearings used with light or medium preload applied.

Table 11-3 Recommended fits for high-precision matched pair angular contact ball bearings with preload applied

(1) Dimensional tolerance of shaft Unit : μm					(2) Dimensional tolerance of housing bore Unit : μm					
Shaft diameter mm		Inner ring rotation		Outer ring rotation	Housing bore diameter mm		Inner ring rotation		Outer ring rotation	
		Tolerance of shaft diameter	Interference between shaft and inner ring (matching adjustment) ¹⁾				Tolerance of housing bore diameter			Clearance ¹⁾ between housing and outer ring
over	up to			Fixed-side bearing	Free-side bearing	over	up to			
6	10	-2 -6	0-2	0 -4	18	30	± 4.5	+9 0	2-6	-6 -12
10	18	-2 -7	0-2	0 -5	30	50	± 5.5	+11 0	2-6	-6 -13
18	30	-2 -8	0-2.5	0 -6	50	80	± 6.5	+13 0	3-8	-8 -16
30	50	-2 -9	0-2.5	0 -7	80	120	± 7.5	+15 0	3-9	-9 -19
50	80	-2 -10	0-3	0 -8	120	180	± 9	+18 0	4-12	-11 -23
80	120	-2 -12	0-4	0 -10	180	250	± 10	+20 0	5-15	-13 -27
120	180	-2 -14	0-5	0 -12	250	315	± 11.5	+23 0	6-18	-16 -32

[Note] 1) Matching adjustment means to measure of bore diameter the bearing and match it to the measured shaft diameter.

[Note] 1) Lower value is desirable for fixed side; higher value for free side.

Table 11-2 Standard preload of high-precision matched pair angular contact ball bearings

Bore diameter No.	7900 C			7000			7000 C				7200			7200 C				ACT 000		ACT 000 B		Bore diameter No.
	S	L	M	L	M	H	S	L	M	H	L	M	H	S	L	M	H	L	M	L	M	
00	5	15	30	30	80	145	6	20	50	100	50	145	245	10	30	80	145	-	-	-	-	00
01	7	20	40	30	80	145	6	20	50	100	60	145	295	15	40	100	195	-	-	-	-	01
02	8	25	50	50	145	245	10	30	80	145	80	245	390	15	50	145	245	-	-	-	-	02
03	8	25	50	60	145	295	15	40	100	165	100	245	540	25	70	145	345	-	-	-	-	03
04	15	40	80	60	145	295	15	40	100	245	145	295	635	25	80	195	390	-	-	-	-	04
05	15	50	100	100	245	490	20	60	145	295	145	390	785	35	100	245	490	-	-	-	-	05
06	15	50	100	145	295	635	25	80	195	390	145	590	930	35	100	295	590	195	345	295	685	06
07	25	70	140	145	390	785	35	100	245	490	245	785	1 270	50	145	390	785	195	390	390	735	07
08	25	80	155	145	390	785	35	100	295	590	390	880	1 570	65	195	440	880	245	440	440	835	08
09	35	100	195	245	540	980	50	145	345	635	490	1 080	1 770	85	245	540	1 080	245	490	490	930	09
10	35	100	195	245	635	1 180	50	145	390	735	540	1 180	2 060	85	245	590	1 180	295	540	540	1 030	10
11	40	120	235	295	785	1 370	65	195	440	880	635	1 370	2 450	100	295	735	1 470	390	685	685	1 270	11
12	40	120	235	390	880	1 570	65	195	490	980	785	1 470	2 940	115	345	785	1 670	390	735	735	1 420	12
13	50	145	295	440	980	1 770	85	245	540	1 090	835	1 670	3 330	130	390	930	1 860	440	835	785	1 520	13
14	65	195	390	490	1 080	2 060	85	245	635	1 270	930	1 860	3 720	160	490	980	2 060	590	1 130	1 030	2 010	14
15	65	195	390	590	1 180	2 150	100	295	685	1 370	980	2 150	3 920	195	590	1 180	2 350	590	1 130	1 080	2 110	15
16	65	195	390	635	1 370	2 350	100	295	735	1 470	1 080	2 450	4 310	225	685	1 370	2 750	685	1 370	1 270	2 500	16
17	85	245	490	735	1 570	2 550	130	390	880	1 770	1 270	2 940	4 900	260	785	1 570	2 940	735	1 420	1 320	2 600	17
18	100	295	590	785	1 670	2 840	145	440	980	1 960	1 470	3 230	5 390	260	785	1 770	3 430	980	1 860	1 770	3 380	18
19	100	295	590	880	1 770	3 140	160	490	1 080	2 060	1 670	3 430	5 880	290	880	1 960	3 920	980	1 960	1 860	3 530	19
20	100	345	685	880	1 960	3 530	175	540	1 180	2 150	1 860	3 920	6 370	325	980	2 150	4 410	1 030	2 010	1 910	3 680	20
21	100	345	685	980	2 150	3 920	195	590	1 270	2 350	2 060	4 310	7 060	360	1 080	2 350	4 900	1 180	2 250	2 150	3 770	21
22	145	390	785	1 080	2 380	4 410	210	635	1 470	2 550	2 250	4 900	7 840	385	1 180	2 450	5 290	1 320	2 600	2 450	4 760	22
24	145	490	980	1 180	2 650	4 900	225	685	1 670	2 840	2 450	5 390	8 820	420	1 270	2 840	5 490	1 420	2 800	2 550	5 100	24
26	195	590	1 180	1 370	3 140	5 390	245	735	1 770	3 140	2 750	5 880	9 310	485	1 470	3 140	5 880	1 770	3 380	3 230	6 230	26
28	195	635	1 270	1 470	3 430	5 880	260	785	1 960	3 920	2 940	6 370	9 800	520	1 570	3 430	6 370	2 010	3 920	3 720	7 210	28
30	245	735	1 470	1 770	3 920	6 860	275	835	2 150	4 410	3 330	6 860	10 300	585	1 770	3 720	6 860	2 500	4 850	4 660	8 920	30
32	245	785	1 570	2 150	4 410	7 840	290	880	2 350	4 900	3 630	7 350	10 800	645	1 960	4 120	7 840	2 500	4 850	4 660	8 920	32
34	345	880	1 810	2 450	4 900	8 820	325	980	2 450	5 390	3 920	7 840	11 800	645	2 150	4 410	8 330	3 090	6 030	5 730	11 100	34

[S : slight preload, L : light preload, M : medium preload, H : heavy preload] Unit : N

11-4-2 Amount of preload for thrust ball bearings

When a thrust ball bearing is rotated at high speed, balls slide on raceway due to centrifugal force and the gyro moment, which often causes the raceway to suffer from smearing or other defects.

To eliminate such sliding, it is necessary to mount the bearing without clearance, and apply an axial load (preload) larger than the minimum necessary axial load determined by the following equation.

When an axial load from the outside is lower than $0.0013 C_{0a}$, there is no adverse effect on the bearing, as long as lubrication is satisfactory.

Generally, deep groove and angular contact ball bearings are recommended for applications when a portion of rotation under axial load is present at high speed.

- Thrust ball bearing (contact angle : 90°)

$$F_{a \min} = 5.1 \left(\frac{n}{1000} \right)^2 \cdot \left(\frac{C_{0a}}{1000} \right)^2 \times 10^{-3} \dots\dots\dots (11-1)$$

- Spherical thrust roller bearing (the higher value determined by the two equations should be taken.)

$$F_{a \min} = \frac{C_{0a}}{2000} \dots\dots\dots (11-2)$$

$$F_{a \min} = 1.8F_r + 1.33 \left(\frac{n}{1000} \right)^2 \cdot \left(\frac{C_{0a}}{1000} \right)^2 \times 10^{-4} \dots\dots\dots (11-3)$$

where :

- $F_{a \min}$: minimum necessary axial load N
- n : rotational speed min^{-1}
- C_{0a} : static axial load rating N
- F_r : radial load N

11-4-3 Amount of preload for spherical thrust roller bearings

Spherical thrust roller bearings sometimes suffer from scuffing, smearing, or other defects due to sliding which occurs between the roller and raceway surface in operation.

To eliminate such sliding, it is necessary to mount the bearing without clearance, and apply an axial load (preload) larger than the minimum necessary axial load.

Of the two values determined by the two equations below, the higher should be defined as the minimum necessary axial load.

12. Bearing lubrication

12-1 Purpose and method of lubrication

Lubrication is one of the most important factors determining bearing performance. The suitability of the lubricant and lubrication method have a dominant influence on bearing life.

Functions of lubrication :

- To lubricate each part of the bearing, and to reduce friction and wear
- To carry away heat generated inside bearing due to friction and other causes
- To cover rolling contact surface with the proper oil film in order to prolong bearing fatigue life
- To prevent corrosion and contamination by dirt

Bearing lubrication is classified broadly into two categories: grease lubrication and oil lubrication. Table 12-1 makes a general comparison between the two.

Table 12-1 Comparison between grease and oil lubrication

Item	Grease	Oil
• Sealing device	Easy	Slightly complicated and special care required for maintenance
• Lubricating ability	Good	Excellent
• Rotation speed	Low/medium speed	Applicable at high speed as well
• Replacement of lubricant	Slightly troublesome	Easy
• Life of lubricant	Relatively short	Long
• Cooling effect	No cooling effect	Good (circulation is necessary)
• Filtration of dirt	Difficult	Easy

12-1-1 Grease lubrication

Grease lubrication is widely applied since there is no need for replenishment over a long period once grease is filled, and a relatively simple structure can suffice for the lubricant sealing device.

There are two methods of grease lubrication. One is the closed lubrication method, in which grease is filled in advance into shielded/sealed bearing; the other is the feeding method, in which the bearing and housing are filled with grease in proper quantities at first, and refilled at a regular interval via replenishment or replacement.

Devices with numerous grease inlets sometimes employ the centralized lubricating method, in which the inlets are connected via piping and supplied with grease collectively.

1) Amount of grease

In general, grease should fill approximately one-third to one-half the inside space, though this varies according to structure and inside space of housing.

It must be borne in mind that excessive grease will generate heat when churned, and will consequently alter, deteriorate, or soften.

When the bearing is operated at low speed, however, the inside space is sometimes filled with grease to two-thirds to full, in order to preclude infiltration of contaminants.

2) Replenishment/replacement of grease

The method of replenishing/replacing grease depends largely on the lubrication method. Whichever method may be utilized, care should be taken to use clean grease and to keep dirt or other foreign matter out of the housing.

In addition, it is desirable to refill with grease of the same brand as that filled at the start.

When grease is refilled, new grease must be injected inside bearing.

Fig. 12-1 gives one example of a feeding method.

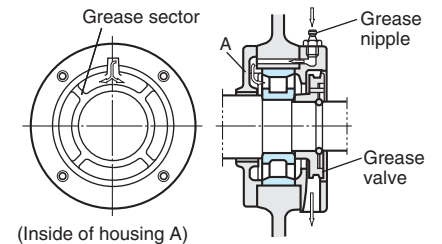

Fig. 12-1 Example of grease feeding method (using grease sector)

In the example, the inside of the housing is divided by grease sectors. Grease fills one sector, then flows into the bearing.

On the other hand, grease flowing back from the inside is forced out of the bearing by the centrifugal force of the grease valve.

When the grease valve is not used, it is necessary to enlarge the housing space on the discharge side to store old grease.

The housing is uncovered and the stored old grease is removed at regular intervals.

3) Grease feeding interval

In normal operation, grease life should be regarded roughly as shown in Fig. 12-2, and replenishment/replacement should be carried out accordingly.

4) Grease life in shielded/sealed ball bearing

Grease life can be estimated by the following equation when a single-row deep groove ball bearing is filled with grease and sealed with shields or seals.

$$\log L = 6.10 - 4.40 \times 10^{-6} d_m n - 3.125 \left(\frac{P_r}{C_r} - 0.04 \right) - (0.021 - 1.80 \times 10^{-6} d_m n) T \dots (12-1)$$

where :

L : grease life h

$d_m = \frac{D+d}{2}$ (D : outside diameter, d : bore diameter) mm

n : rotational speed min⁻¹

P_r : dynamic equivalent radial load N

C_r : basic dynamic radial load rating N

T : operating temperature of bearing °C

The conditions for applying equation (12-1) are as follows :

a) Operating temperature of bearing : T °C

Applicable when $T \leq 120$

(when $T < 50$,
 $T = 50$)

When $T > 120$, please contact with JTEKT.

c) Load condition : $\frac{P_r}{C_r}$

Applicable when $\frac{P_r}{C_r} \leq 0.16$

(when $\frac{P_r}{C_r} < 0.04$,
 $\frac{P_r}{C_r} = 0.04$)

b) Value of $d_m n$

Applicable when $d_m n \leq 500 \times 10^3$

(when $d_m n < 125 \times 10^3$,
 $d_m n = 125 \times 10^3$)

When $d_m n > 500 \times 10^3$, please contact with JTEKT.

When $\frac{P_r}{C_r} > 0.16$, please contact with JTEKT.

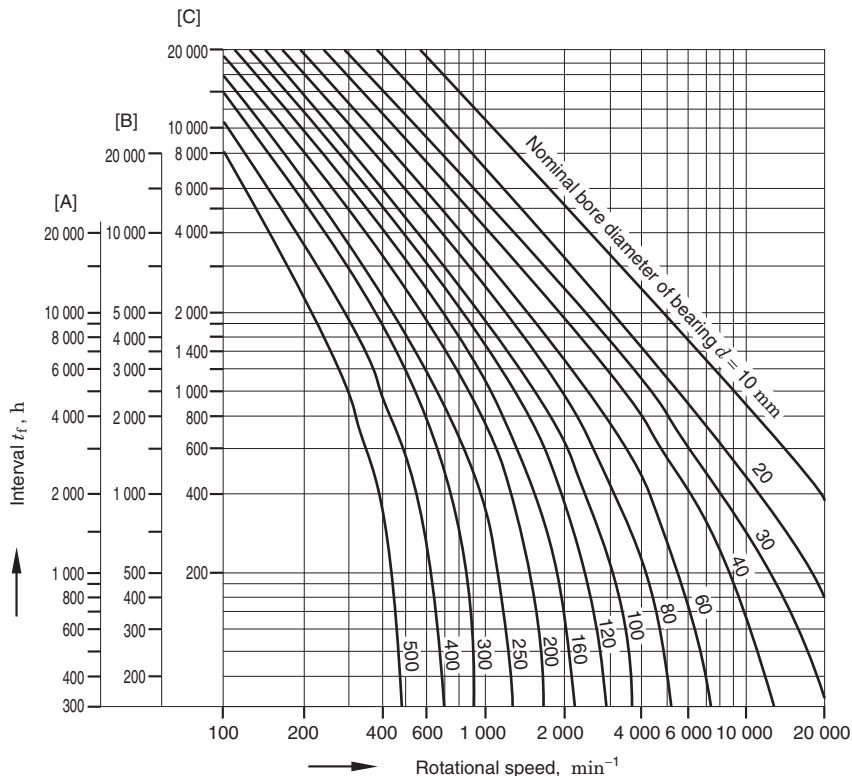

[Notes] 1) [A] : radial ball bearing

[B] : cylindrical roller bearing, needle roller bearing

[C] : tapered roller bearing, spherical roller bearing, thrust ball bearing

2) Temperature correction

When the bearing operating temperature exceeds 70°C, t_f' , obtained by multiplying t_f by correction coefficient a , found on the scale below, should be applied as the feeding interval.

$$t_f' = t_f \times a$$

Temperature correction coefficient a

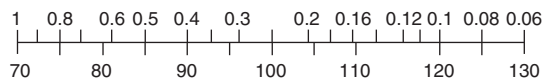

Bearing operating temperature T °C

Fig. 12-2 Grease feeding interval

12-1-2 Oil lubrication

Oil lubrication is usable even at high speed rotation and somewhat high temperature, and is effective in reducing bearing vibration and noise.

Thus oil lubrication is used in many cases where grease lubrication does not work.

Table 12-2 shows major types and methods of oil lubrication.

Table 12-2 Type and method of oil lubrication

<p>① Oil bath</p>	<ul style="list-style-type: none"> • Simplest method of bearing immersion in oil for operation. • Suitable for low/medium speed. • Oil level gauge should be furnished to adjust the amount of oil. (In the case of horizontal shaft) About 50 % of the lowest rolling element should be immersed. (In the case of vertical shaft) About 70 to 80 % of the bearing should be immersed. • It is better to use a magnetic plug to prevent wear iron particles from dispersing in oil. 	<p>a magnetic plug</p>
<p>② Oil drip</p>	<ul style="list-style-type: none"> • Oil is dripped with an oiling device, and the inside of the housing is filled with oil mist by the action of rotating parts. This method has a cooling effect. • Applicable at relatively high speed and up to medium load. • In general, 5 to 6 drops of oil are utilized per minute. (It is difficult to adjust the dripping in 1mL/h or smaller amounts.) • It is necessary to prevent too much oil from being accumulated at the bottom of housing. 	
<p>③ Oil splash</p>	<ul style="list-style-type: none"> • This type of lubrication method makes use of a gear or simple flinger attached to shaft in order to splash oil. This method can supply oil for bearings located away from the oil tank. • Usable up to relatively high speed. • It is necessary to keep oil level within a certain range. • It is better to use a magnetic plug to prevent wear iron particles from dispersing in oil. It is also advisable to set up a shield or baffle board to prevent contaminants from entering the bearing. 	

<p>④ Forced oil circulation</p>	<ul style="list-style-type: none"> • This method employs a circulation-type oil supply system. Supplied oil lubricates inside of the bearing, is cooled and sent back to the tank through an oil escape pipe. • Widely used at high speeds and high temperature conditions. • It is better to use an oil escape pipe approximately twice as thick as the oil supply pipe in order to prevent too much lubricant from gathering in housing. • Required amount of oil : see Remark 1. 	
<p>⑤ Oil jet lubrication</p>	<ul style="list-style-type: none"> • This method uses a nozzle to jet oil at a constant pressure (0.1 to 0.5MPa), and is highly effective in cooling. • Suitable for high speed and heavy load. • Generally, the nozzle (diameter 0.5 to 2 mm) is located 5 to 10 mm from the side of a bearing. When a large amount of heat is generated, 2 to 4 nozzles should be used. • Since a large amount of oil is supplied in the jet lubrication method, old should be discharged with an oil pump to prevent excessive residual oil. • Required amount of oil : see Remark 1. 	
<p>⑥ Oil mist lubrication (spray lubrication)</p>	<ul style="list-style-type: none"> • This method employs an oil mist generator to produce dry mist (air containing oil in the form of mist). The dry mist is continuously sent to the oil supplier, where the mist is turned into a wet mist (sticky oil drops) by a nozzle set up on the housing or bearing, and is then sprayed onto bearing. • Required amount of mist : see Remark 2. <p>(Example of grinding machine)</p>	<ul style="list-style-type: none"> • This method provides and sustains the smallest amount of oil film necessary for lubrication, and has the advantages of preventing oil contamination, simplifying bearing maintenance, prolonging bearing fatigue life, reducing oil consumption etc. <p>(Example of rolling mill)</p>

⑦
Oil/air
lubrication

- A proportioning pump sends forth a small quantity of oil, which is mixed with compressed air by a mixing valve. The admixture is supplied continuously and stably to the bearing.
- This method enables quantitative control of oil in extremely small amounts, always supplying new lubricating oil. It is thus suitable for machine tools and other applications requiring high speed.
- Compressed air and lubricating oil are supplied to the spindle, increasing the internal pressure and helping prevent dirt, cutting-liquid, etc. from entering. As well, this method allows the lubricating oil to flow through a feeding pipe, minimizing atmospheric pollution.
- JTEKT produces an oil/air lubricator and, air cleaner, as well as a spindle unit incorporating the oil/air lubrication system. Please refer to brochure "oil/air lubricator & air clean unit".

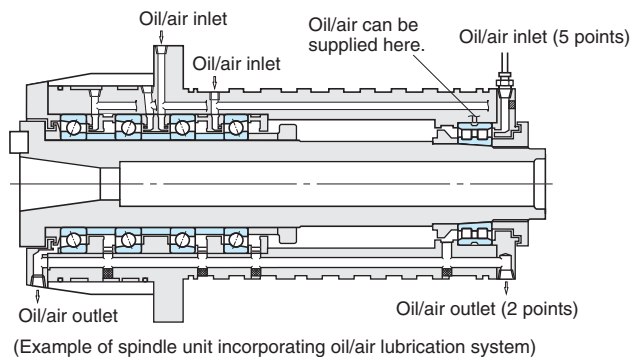

Remark 1 Required oil supply in forced oil circulation ; oil jet lubrication methods

$$G = \frac{1.88 \times 10^{-4} \mu \cdot d \cdot n \cdot P}{60 \cdot c \cdot r \cdot \Delta T}$$

- where :
- G : required oil supply L/min
 - μ : friction coefficient (see table at right)
 - d : nominal bore diameter mm
 - n : rotational speed min^{-1}
 - P : dynamic equivalent load of bearing N
 - c : specific heat of oil 1.88-2.09kJ/kg·K
 - r : density of oil g/cm^3
 - ΔT : temperature rise of oil K

Values of friction coefficient μ

Bearing type	μ
Deep groove ball bearing	0.001 0 – 0.001 5
Angular contact ball bearing	0.001 2 – 0.002 0
Cylindrical roller bearing	0.000 8 – 0.001 2
Tapered roller bearing	0.001 7 – 0.002 5
Spherical roller bearing	0.002 0 – 0.002 5

The values obtained by the above equation show quantities of oil required to carry away all the generated heat, with heat release not taken into consideration.

In reality, the oil supplied is generally half to two-thirds of the calculated value.

Heat release varies widely according to the application and operating conditions.

To determine the optimum oil supply, it is advised to start operating with two-thirds of the calculated value, and then reduce the oil gradually while measuring the operating temperature of bearing, as well as the supplied and discharged oil.

Remark 2 Notes on oil mist lubrication

- 1) Required amount of mist (mist pressure : 5 kPa)

$$Q = 0.11dR$$

(In the case of a bearing)

$$Q = 0.028d_1$$

(In the case of two oil seals combined)

- where :
- Q : required amount of mist L/min
 - d : nominal bore diameter mm
 - R : number of rolling element rows
 - d_1 : inside diameter of oil seal mm

In the case of high speed ($d_m n \geq 400 \times 10^3$), it is necessary to increase the amount of oil and heighten the mist pressure.

- 2) Piping diameter and design of lubrication hole/groove

When the flow rate of mist in piping exceeds 5 m/s, oil mist suddenly condenses into an oil liquid.

Consequently, the piping diameter and dimensions of the lubrication hole/groove in the housing should be designed to keep the flow rate of mist, obtained by the following equation, from exceeding 5 m/s.

$$V = \frac{0.167Q}{A} \leq 5$$

- where :
- V : flow rate of mist m/s
 - Q : amount of mist L/min
 - A : sectional area of piping or lubrication groove cm^2

- 3) Mist oil

Oil used in oil mist lubrication should meet the following requirements.

- ability to turn into mist
- has high extreme pressure resistance
- good heat/oxidation stability
- rust-resistant
- unlikely to generate sludge
- superior demulsifier

Oil mist lubrication has a number of advantages for high speed rotation bearings. Its performance, however, is largely affected by surrounding structures and bearing operating conditions.

If contemplating the use of this method, please contact with JTEKT for advice based on JTEKT long experience with oil mist lubrication.

12-2 Lubricant

12-2-1 Grease

Grease is made by mixing and dispersing a solid of high oil-affinity (called a thickener) with lubricant oil (as a base), and transforming it into a semi-solid state.

As well, a variety of additives can be added to improve specific performance.

(1) Base oil

Mineral oil is usually used as the base oil for grease. When low temperature fluidity, high temperature stability, or other special performance is required, diester oil, silicon oil, polyglycolic oil, fluorinated oil, or other synthetic oil is often used.

Generally, grease with a low viscosity base oil is suitable for applications at low temperature or high rotation speed; grease with high viscosity base oils are suitable for applications at high temperature or under heavy load.

(2) Thickener

Most greases use a metallic soap base such as lithium, sodium, or calcium as thickeners. For some applications, however, non-soap base thickeners (inorganic substances such as bentone, silica gel, and organic substances such as urea compounds, fluorine compounds) are also used.

In general, the mechanical stability, bearing operating temperature range, water resistance, and other characteristics of grease are determined by the thickener.

(Lithium soap base grease)

Superior in heat resistance, water resistance and mechanical stability.

(Calcium soap base grease)

Superior in water resistance; inferior in heat resistance.

(Sodium soap base grease)

Superior in heat resistance; inferior in water resistance.

(Non-soap base grease)

Superior in heat resistance.

(3) Additives

Various additives are selectively used to serve the respective purposes of grease applications.

• Extreme pressure agents

When bearings must tolerate heavy or impact loads.

• Oxidation inhibitors

When grease is not refilled for a long period.

Structure stabilizers, rust preventives, and corrosion inhibitors are also used.

(4) Consistency

Consistency, which indicates grease hardness, is expressed as a figure obtained, in accordance with ASTM (JIS), by multiplication by 10 the depth (in mm) to which the cone-shaped metallic plunger penetrates into the grease at 25°C by deadweight in 5 seconds. The softer the grease, the higher the figure.

Table 12-4 shows the relationships between the NLGI scales and ASTM (JIS) penetration indexes, service conditions of grease.

(NLGI : National Lubricating Grease Institute)

Table 12-4 Grease consistency

NLGI scale	ASTM (JIS) penetration index (25°C, 60 mixing operations)	Service conditions/ applications
0	355 – 385	For centralized lubricating
1	310 – 340	For centralized lubricating, at low temperature
2	265 – 295	For general use
3	220 – 250	For general use, at high temperature
4	175 – 205	For special applications

(5) Mixing of different greases

Since mixing of different greases changes their properties, greases of different brands should not be mixed.

If mixing cannot be avoided, greases containing the same thickener should be used. Even if the mixed greases contain the same thickener, however, mixing may still produce adverse effects, due to difference in additives or other factors.

Thus it is necessary to check the effects of a mixture in advance, through testing or other methods.

Table 12-3 Characteristics of respective greases

	Lithium grease			Calcium grease (cup grease)	Sodium grease (fiber grease)		Complex base grease		Non-soap base grease			
	Thickener	Lithium soap		Calcium soap	Sodium soap		Lithium complex soap	Calcium complex soap	Bentone	Urea compounds	Fluorine compounds	
Base oil	Mineral oil	Synthetic oil (diester oil)	Synthetic oil (silicon oil)	Mineral oil	Mineral oil		Mineral oil	Mineral oil	Mineral oil	Mineral/synthetic oil	Synthetic oil	Base oil
Dropping point (°C)	170 to 190	170 to 230	220 to 260	80 to 100	160 to 180		250 or higher	200 to 280	–	240 or higher	250 or higher	Dropping point (°C)
Operating temperature range (°C)	– 30 to + 120	– 50 to + 130	– 50 to + 180	– 10 to + 70	0 to + 110		– 30 to + 150	– 10 to + 130	– 10 to + 150	– 30 to + 150	– 40 to + 250	Operating temperature range (°C)
Rotation speed range	Medium to high	High	Low to medium	Low to medium	Low to high		Low to high	Low to medium	Medium to high	Low to high	Low to medium	Rotation speed range
Mechanical stability	Excellent	Good to excellent	Good	Fair to good	Good to excellent		Good to excellent	Good	Good	Good to excellent	Good	Mechanical stability
Water resistance	Good	Good	Good	Good	Bad		Good to excellent	Good	Good	Good to excellent	Good	Water resistance
Pressure resistance	Good	Fair	Bad to fair	Fair	Good to excellent		Good	Good	Good to excellent	Good to excellent	Good	Pressure resistance
Remarks	Most widely usable for various rolling bearings.	Superior low temperature and friction characteristics. Suitable for bearings for measuring instruments and extra-small ball bearings for small electric motors.	Superior high and low temperature characteristics.	Suitable for applications at low rotation speed and under light load. Not applicable at high temperature.	Liable to emulsify in the presence of water. Used at relatively high temperature.		Superior mechanical stability and heat resistance. Used at relatively high temperature.	Superior pressure resistance when extreme pressure agent is added. Used in bearings for rolling mills.	Suitable for applications at high temperature and under relatively heavy load.	Superior water resistance, oxidation stability, and heat stability. Suitable for applications at high temperature and high speed.	Superior chemical resistance and solvent resistance. Usable at up to 250 °C.	Remarks

Table 12-5 Typical examples of standard grease for JTEKT bearings

Grease name	Thickener	Base oil	Appearance	Consistency 60W		NLGI scale	Operating temperature range (°C)	Application examples	
				Unworked	Worked				
Alvania 2	Lithium	Mineral oil	Grayish brown	276	275	2	-10 - 100	Automobile	Steering column
Raremax AF-I	Urea	Mineral oil	Pale yellow, viscous	-	300	1 - 2 ²⁾	0 - 150		Wheel (hub unit)
FS841	Fluororesin	Fluorosilicone oil	White	-	290	2	-40 - 220		Fan coupling
Sunlight 2	Lithium	Mineral oil	Yellowish brown	-	280	2	-10 - 100		Universal joint (shell type), steering joint
Unirex N3	Lithium complex	Mineral oil	Green	-	235	3	-10 - 130		Clutch release
W191	Urea	PAO ¹⁾ , mineral oil	Pale yellow	247	275	2	-30 - 130		Water pump bearing
Darina 2	Microgel	Mineral oil	Amber	-	280	2	0 - 150	Steel production	Conveyor
Emalube L	Urea	Mineral oil	Light brown, viscous	-	350	0 - 1 ²⁾	-10 - 200		Continuous casting machine
Palmax RBG	Special lithium complex	Mineral oil	Yellow, viscous	-	300	1 - 2 ²⁾	-10 - 150		Rolling mill roll neck
4B grease	Carbon black	Ethyl oil	Black	-	260	2 - 3 ²⁾	-30 - 250	Extra-small/miniature ball bearings	Photocopier (high temperature/conductive), printer (high temperature/conductive)
KRYTOX GPL 226	Fluororesin	Fluorinated oil		-	280	2	0 - 250		Photocopier (high temperature), printer (high temperature)
Multemp PSNo.2	Lithium	Mineral oil, ester oil	Pinkish white, viscous	-	275	2	-40 - 100		Motor (for low temperatures)
KVC grease	Urea	PAO ¹⁾ , ester oil	Milkish pink	-	244	3	-30 - 150		Motor (for high temperatures), rotary encoder, fan motor (for high temperatures)
SR grease	Lithium	Ester oil	Light brown, viscous	-	250	3	-40 - 130	Extra-small/miniature ball bearings, automobile	Motor, stepping motor, fan motor Center bearing (for propeller shafts), steering column
KDL grease	Fluororesin (PTFE)	Fluorinated oil	White	-	260	2 - 3 ²⁾	-30 - 200	Semiconductor manufacturing equipment	For high temperatures, for clean environment, for vacuum environment
KHD	Lithium	PAO ¹⁾	White	-	199	4	-30 - 120		For room temperature, for atmosphere
Nerita 2858	Lithium	Mineral oil (XHVI)	Yellowish brown	-	279	2	-30 - 100	Railway rolling stock	Axle journal (ABU)
Arapen RB 320	Lithium, calcium	Mineral oil	Yellowish brown	-	315	1	-30 - 90		Axle journal (general)
Isoflex NBU 15	Barium complex	Ester oil	Beige	270	280	2	-40 - 100	Machine tool spindle	Universal joint, king pin thrust bearing
Shell Cassida grease RLS2	Aluminum complex	PAO ¹⁾	Transparent	-	280	2	-20 - 100	For food machinery	
Alvania EP2	Lithium	Mineral oil	Brown	282	276	2	-10 - 80	Slewing rim, automobile	
Alvania 3	Lithium	Mineral oil	Brown	240	225	3	-10 - 100	Agricultural machinery	

[Notes] 1) PAO: Polyalphaolefin oil

2) The value is within the range specified by the consistency numbers.

12-2-2 Lubricating oil

For lubrication, bearings usually employ highly refined mineral oils, which have superior oxidation stability, rust-preventive effect, and high film strength.

With bearing diversification, however, various synthetic oils have been put into use.

These synthetic oils contain various additives (oxidation inhibitors, rust preventives, antifoaming agents, etc.) to improve specific properties. Table 12-6 shows the characteristics of lubricating oils.

Mineral lubricating oils are classified by applications in JIS and MIL.

Table 12-6 Characteristics of lubricating oils

Type of lubricating oil	Highly refined mineral oil	Major synthetic oils				
		Diester oil	Silicon oil	Polyglycolic oil	Polyphenyl ether oil	Fluorinated oil
Operating temperature range (°C)	-40 to +220	-55 to +150	-70 to +350	-30 to +150	0 to +330	-20 to +300
Lubricity	Excellent	Excellent	Fair	Good	Good	Excellent
Oxidation stability	Good	Good	Fair	Fair	Excellent	Excellent
Radioactivity resistance	Bad	Bad	Bad to fair	Bad	Excellent	-

[Selection of lubricating oil]

The most important criterion in selecting a lubricating oil is whether the oil provides proper viscosity at the bearing operating temperature.

Standard values of proper kinematic viscosity can be obtained through selection by bearing type according to Table 12-7 first, then through selection by bearing operating conditions according to Table 12-8.

When lubricating oil viscosity is too low, the oil film will be insufficient. On the other hand, when the viscosity is too high, heat will be generated due to viscous resistance.

In general, the heavier the load and the higher the operating temperature, the higher the lubricating oil viscosity should be ; whereas, the higher the rotation speed, the lower the viscosity should be.

Fig. 12-3 illustrates the relationship between lubricating oil viscosity and temperature.

Table 12-7 Proper kinematic viscosity by bearing type

Bearing type	Proper kinematic viscosity at operating temperature
Ball bearing Cylindrical roller bearing	13mm ² /s or higher
Tapered roller bearing Spherical roller bearing	20mm ² /s or higher
Spherical thrust roller bearing	32mm ² /s or higher

Table 12-8 Proper kinematic viscosities by bearing operating conditions

Operating temperature	d _m n value	Proper kinematic viscosity (expressed in the ISO viscosity grade or the SAE No.)	
		Light/normal load	Heavy/impact load
-30 to 0°C	All rotation speeds	ISO VG 15, 22, 46 (Refrigerating machine oil)	---
0 to 60°C	300 000 or lower	ISO VG 46 (Bearing oil Turbine oil)	ISO VG 68 SAE 30 (Bearing oil Turbine oil)
	300 000 to 600 000	ISO VG 32 (Bearing oil Turbine oil)	ISO VG 68 (Bearing oil Turbine oil)
	600 000 or higher	ISO VG 7, 10, 22 (Bearing oil)	---
60 to 100°C	300 000 or lower	ISO VG 68 (Bearing oil)	ISO VG 68, 100 SAE 30 (Bearing oil)
	300 000 to 600 000	ISO VG 32, 46 (Bearing oil Turbine oil)	ISO VG 68 (Bearing oil Turbine oil)
	600 000 or higher	ISO VG 22, 32, 46 (Bearing oil Turbine oil Machine oil)	---
100 to 150°C	300 000 or lower	ISO VG 68, 100 SAE 30, 40 (Bearing oil)	ISO VG 100 to 460 (Bearing oil Gear oil)
	300 000 to 600 000	ISO VG 68 SAE 30 (Bearing oil Turbine oil)	ISO VG 68, 100 SAE 30, 40 (Bearing oil)

[Remarks] 1. $d_m n = \frac{D+d}{2} \times n$... { D : nominal outside diameter (mm), d : nominal bore diameter (mm), n : rotational speed (min⁻¹) }

2. Refer to refrigerating machine oil (JIS K 2211), turbine oil (JIS K 2213), gear oil (JIS K 2219), machine oil (JIS K 2238) and bearing oil (JIS K 2239).

3. Please contact with JTEKT if the bearing operating temperature is under -30°C or over 150°C .

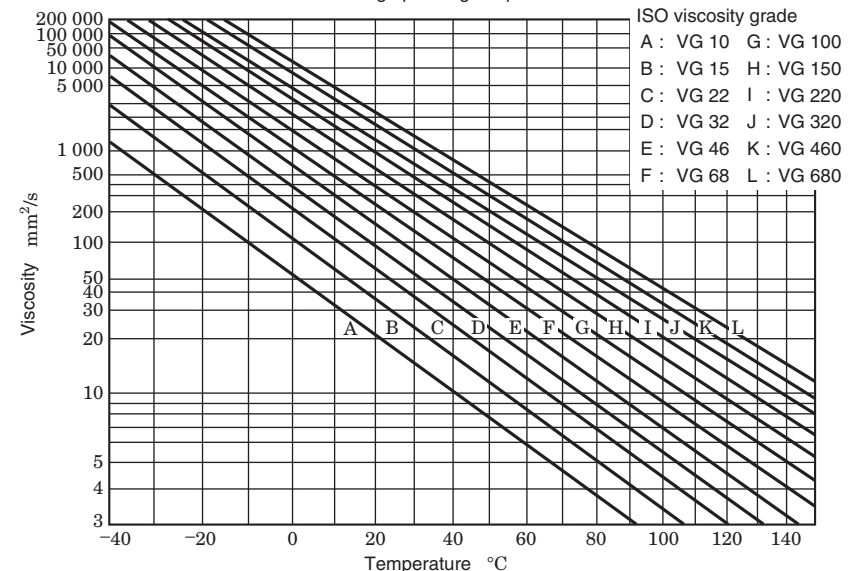

Fig. 12-3 Relationship between lubricating oil viscosity and temperature (viscosity index :100)

13. Bearing materials

Bearing materials include steel for bearing rings and rolling elements, as well as steel sheet, steel, copper alloy and synthetic resins for cages.

These bearing materials should possess the following characteristics :

- | | |
|--|--|
| 1) High elasticity, durable under high partial contact stress. | } Bearing rings |
| 2) High strength against rolling contact fatigue due to large repetitive contact load. | |
| 3) Strong hardness | } Rolling elements |
| 4) High abrasion resistance | |
| 5) High toughness against impact load | } Bearing rings
Rolling elements
Cages |
| 6) Excellent dimensional stability | |

13-1 Bearing rings and rolling elements materials

1) High carbon chromium bearing steel

High carbon chromium bearing steel specified in JIS is used as a general material in bearing rings (inner rings, outer rings) and rolling elements (balls, rollers).

Their chemical composition classified by steel type is given in Table 13-1.

Among these steel types, SUJ 2 is generally used. SUJ 3, which contains additional Mn and Si, possesses high hardenability and is commonly used for thick section bearings.

SUJ 5 has increased hardenability, because it was developed by adding Mo to SUJ 3.

For small and medium size bearings, SUJ 2 and SUJ 3 are used, and for large size and extra-large size bearings with thick sections, SUJ 5 is widely used.

Generally, these materials are processed into the specified shape and then undergo hardening and annealing treatment until they attain a hardness of 57 to 64 HRC.

Table 13-1 Chemical composition of high carbon chromium bearing steel

Standard	Code	Chemical composition (%)						
		C	Si	Mn	P	S	Cr	Mo
JIS G 4805	SUJ 2	0.95 – 1.10	0.15 – 0.35	Not more than 0.50	Not more than 0.025	Not more than 0.025	1.30 – 1.60	Not more than 0.08
	SUJ 3	0.95 – 1.10	0.40 – 0.70	0.90 – 1.15			0.90 – 1.20	Not more than 0.08
	SUJ 5	0.95 – 1.10	0.40 – 0.70	0.90 – 1.15			0.90 – 1.20	0.10 – 0.25
SAE J 404	52100	0.98 – 1.10	0.15 – 0.35	0.25 – 0.45	Not more than 0.025	Not more than 0.025	1.30 – 1.60	Not more than 0.06

[Remark] As for bearings which are induction hardened, carbon steel with a high carbon content of 0.55 to 0.65 % is used in addition to those listed in this table.

2) Case carburizing bearing steel (case hardened steel)

When a bearing receives heavy impact loads, the surface of the bearing should be hard and the inside soft.

Such materials should possess a proper amount of carbon, dense structure, and carburizing case depth on their surface, while having proper hardness and fine structure internally.

For this purpose, chromium steel and nickel-chromium-molybdenum steel are used as materials.

Typical steel materials are shown in Table 13-2.

3) Steel for Standard JTEKT Specification Bearings

In general terms, it is known that the non-metallic inclusions contained in materials are harmful to the rolling contact fatigue life.

At JTEKT, to reduce the amount of non-metallic inclusions, which are harmful to the fatigue life, we set the chemical compounds of the bearing steel in a proprietary manner. As a result, JTEKT standard bearings have a life that is approximately twice as long as the general bearings that are targeted by JIS B 1518 (and ISO 281).

Therefore, the basic dynamic load ratings of JTEKT standard bearings are 1.25 times the dynamic load ratings established in JIS B 1518 (and ISO 281).

This steel for standard JTEKT specification bearings is not applied to the special application bearings in this general catalog. If you require special application bearings with long lives, contact JTEKT.

4) Other

For special applications, the special heat treatment shown below can be used according to various usage conditions.

[Extremely high reliability]

· SH bearings ¹⁾

..... By using the heat treatment technology developed by JTEKT to perform special heat treatment on high carbon chromium bearing steel, we have improved the surface hardness of these products and provided them with compressive residual stress, which has led to high reliability especially in terms of resistance to foreign matter.

· KE bearings ²⁾

..... By using the heat treatment technology developed by JTEKT to perform special heat treatment on carburized bearing steel, we have improved the surface hardness of these products and adjusted their amount of residual austenite, which has led to high reliability especially in terms of resistance to foreign matter.

1) Acronym of Special Heat treatment

2) Acronym of Koyo EXTRA-LIFE Bearing

Table 13-2 Chemical composition of case carburizing bearing steel

Standard	Code	Chemical composition (%)							
		C	Si	Mn	P	S	Ni	Cr	Mo
JIS G 4053	SCr 415	0.13 – 0.18	0.15 – 0.35	0.60 – 0.85	Not more than 0.030	Not more than 0.030	–	0.90 – 1.20	–
	SCr 420	0.18 – 0.23	0.15 – 0.35	0.60 – 0.85			–	0.90 – 1.20	–
	SCM 420	0.18 – 0.23	0.15 – 0.35	0.60 – 0.85	Not more than 0.030	Not more than 0.030	–	0.90 – 1.20	0.15 – 0.30
	SNCM 220	0.17 – 0.23	0.15 – 0.35	0.60 – 0.90			0.40 – 0.70	0.40 – 0.65	0.15 – 0.30
	SNCM 420	0.17 – 0.23	0.15 – 0.35	0.40 – 0.70	Not more than 0.030	Not more than 0.030	1.60 – 2.00	0.40 – 0.65	0.15 – 0.30
	SNCM 815	0.12 – 0.18	0.15 – 0.35	0.30 – 0.60			4.00 – 4.50	0.70 – 1.00	0.15 – 0.30
SAE J 404	5120	0.17 – 0.22	0.15 – 0.35	0.70 – 0.90	Not more than 0.035	Not more than 0.040	–	0.70 – 0.90	–
	8620	0.18 – 0.23	0.15 – 0.35	0.70 – 0.90	Not more than 0.035	Not more than 0.040	0.40 – 0.70	0.40 – 0.60	0.15 – 0.25
	4320	0.17 – 0.22	0.15 – 0.30	0.45 – 0.65	Not more than 0.025	Not more than 0.025	1.65 – 2.00	0.40 – 0.60	0.20 – 0.30

13-2 Materials used for cages

Since the characteristics of materials used for cages greatly influence the performance and reliability of rolling bearings, the choice of materials is of great importance.

It is necessary to select cage materials in accordance with required shape, ease of lubrication, strength, and abrasion resistance.

Typical materials used for metallic cages are shown in Tables 13-3 and 13-4.

In addition, phenolic resin machined cages and other synthetic resin molded cages are often used.

Materials typically used for molded cages are polyacetal, polyamide (Nylon 6.6, Nylon 4.6), and polymer containing fluorine, which are strengthened with glass and carbon fibers.

Table 13-3 Chemical compositions of pressed cage steel sheet (A) and machined cage carbon steel (B)

	Standard	Code	Chemical composition (%)						
			C	Si	Mn	P	S	Ni	Cr
(A)	JIS G 3141	SPCC	Not more than 0.12	-	Not more than 0.50	Not more than 0.040	Not more than 0.045	-	-
	JIS G 3131	SPHC	Not more than 0.15	-	Not more than 0.60	Not more than 0.050	Not more than 0.050	-	-
	BAS 361	SPB 2	0.13 - 0.20	Not more than 0.04	0.25 - 0.60	Not more than 0.030	Not more than 0.030	-	-
	JIS G 4305	SUS 304	Not more than 0.08	Not more than 1.00	Not more than 2.00	Not more than 0.045	Not more than 0.030	8.00 - 10.50	18.00 - 20.00
(B)	JIS G 4051	S 25 C	0.22 - 0.28	0.15 - 0.35	0.30 - 0.60	Not more than 0.030	Not more than 0.035	-	-

Table 13-4 Chemical composition of high-tensile brass casting of machined cages (%)

Standard	Code	Cu	Zn	Mn	Fe	Al	Sn	Ni	Impurity	
									Pb	Si
JIS H 5120	CAC 301 (HBsC*)	55 - 60	33 - 42	0.1 - 1.5	0.5 - 1.5	0.5 - 1.5	Not more than 1.0	Not more than 1.0	Not more than 0.4	Not more than 0.1

* : Material with HBsC is used.

14. Shaft and housing design

In designing the shaft and housing, the following should be taken into consideration.

- 1) Shafts should be thick and short. (in order to reduce distortion including bending)
 - 2) Housings should possess sufficient rigidity. (in order to reduce distortion caused by load)
- [Note] · For light alloy housings, rigidity may be provided by inserting a steel bushing.

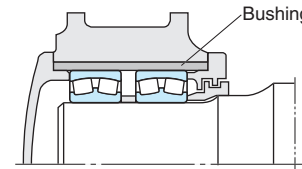

Fig. 14-1 Example of light alloy housing

- 3) The fitting surface of the shaft and housing should be finished in order to acquire the required accuracy and roughness. The shoulder end-face should be finished in order to be perpendicular to the shaft center or housing bore surface. (refer to Table 14-1)
 - 4) The fillet radius (r_a) should be smaller than chamfer dimension of the bearing. (refer to Tables 14-2, 14-3)
- [Notes] · Generally it should be finished so as to form a simple circular arc. (refer to Fig. 14-2)
- When the shaft is given a ground finish, a recess may be provided. (Fig. 14-3)

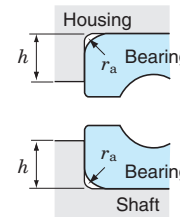

Fig. 14-2 Fillet radius

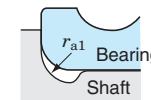

Fig. 14-3 Grinding undercut

- 5) The shoulder height (h) should be smaller than the outside diameter of inner ring and larger than bore diameter of outer ring so that the bearing is easily dismounted. (refer to Fig. 14-2 and Table 14-2)
- 6) If the fillet radius must be larger than the bearing chamfer, or if the shaft/housing shoulder must be low/high, insert a spacer between the inner ring and shaft shoulder as shown in Fig. 14-4, or between the outer ring and the housing shoulder.

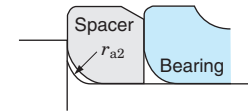

Fig. 14-4 Example of shaft with spacer

- 7) Screw threads and lock nuts should be completely perpendicular to shaft axis. It is desirable that the tightening direction of threads and lock nuts be opposite to the shaft rotating direction.
- 8) When split housings are used, the surfaces where the housings meet should be finished smoothly and provided with a recess at the inner ends of the surfaces that meet.

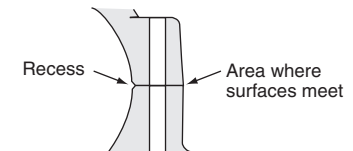

Fig. 14-5 Recesses on meeting surfaces

14-1 Accuracy and roughness of shafts and housings

The fitting surface of the shaft and housing may be finished by turning or fine boring when the bearing is used under general operating conditions. However, if the conditions require minimum vibration and noise, or if the bearing is used under severe operating conditions, a ground finish is required.

Recommended accuracy and roughness of shafts and housings under general conditions are given in Table 14-1.

Table 14-1 Recommended accuracy and roughness of shafts and housings

Item	Bearing class	Shaft	Housing bore
Roundness tolerance	classes 0, 6	IT 3 – IT 4	IT 4 – IT 5
	classes 5, 4	IT 2 – IT 3	IT 2 – IT 3
Cylindrical form tolerance	classes 0, 6	IT 3 – IT 4	IT 4 – IT 5
	classes 5, 4	IT 2 – IT 3	IT 2 – IT 3
Shoulder runout tolerance	classes 0, 6	IT 3	IT 3 – IT 4
	classes 5, 4	IT 3	IT 3
Roughness of fitting surfaces Ra	Small size bearings	0.8 a	1.6 a
	Large size bearings	1.6 a	3.2 a

[Remark] Refer to the figures listed in the attached table when the basic tolerance IT is required.

Table 14-2 Shaft/housing fillet radius and shoulder height of radial bearings

Unit : mm

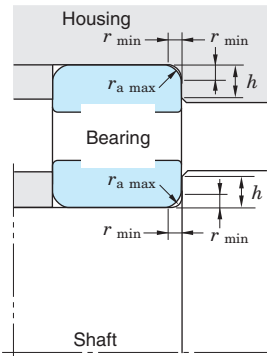

Chamfer dimension of inner ring or outer ring r_{min}	Shaft and housing		
	Fillet radius $r_{a\ max}$	Shoulder height h_{min}	
		General cases ¹⁾	Special cases ²⁾
0.05	0.05	0.3	0.3
0.08	0.08	0.3	0.3
0.1	0.1	0.4	0.4
0.15	0.15	0.6	0.6
0.2	0.2	0.8	0.8
0.3	0.3	1.25	1
0.5	0.5	1.75	1.5
0.6	0.6	2.25	2
0.8	0.8	2.75	2.5
1	1	2.75	2.5
1.1	1	3.5	3.25
1.5	1.5	4.25	4
2	2	5	4.5
2.1	2	6	5.5
2.5	2	6	5.5
3	2.5	7	6.5
4	3	9	8
5	4	11	10
6	5	14	12
7.5	6	18	16
9.5	8	22	20
12	10	27	24
15	12	32	29
19	15	42	38

[Notes]

- Shoulder heights greater than those specified in the Table are required to accommodate heavy axial loads.
- Used when an axial load is small. These values are not recommended for tapered roller bearings, angular contact ball bearings, or spherical roller bearings.

[Remark]

Fillet radius can be applied to thrust bearings.

14-2 Mounting dimensions

Mounting dimensions mean the necessary dimensions to mount bearings on shafts or housings, which include the fillet radius or shoulder diameters.

Standard values are shown in Table 14-2. (The mounting related dimensions of each bearing are given in the bearing specification table.)

The grinding undercut dimensions for ground shafts are given in Table 14-3.

For thrust bearings, the mounting dimensions should be carefully determined such that bearing race will be perpendicular to the support and the supporting area will be wide enough.

For thrust ball bearings, the shaft shoulder diameter d_a should be larger than pitch diameter of ball set, while the shoulder diameter of housing D_a should be smaller than the pitch diameter of ball set. (Fig. 14-6)

For thrust roller bearings, the housing/shaft diameter D_a/d_a should cover the lengths of both rollers. (Fig. 14-7)

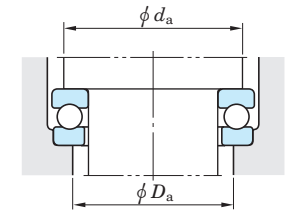

Fig. 14-6 Thrust ball bearings

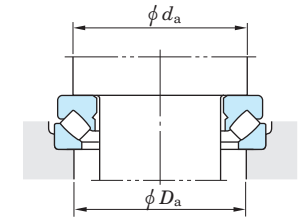
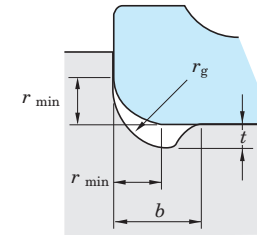

Fig. 14-7 Spherical thrust roller bearings

Table 14-3 Grinding undercut dimensions for ground shafts



Unit : mm

Chamfer dimension of inner ring r_{min}	Grinding undercut dimensions		
	t	r_g	b
1	0.2	1.3	2
1.1	0.3	1.5	2.4
1.5	0.4	2	3.2
2	0.5	2.5	4
2.1	0.5	2.5	4
3	0.5	3	4.7
4	0.5	4	5.9
5	0.6	5	7.4
6	0.6	6	8.6
7.5	0.6	7	10

14-3 Shaft design

When bearings are mounted on shafts, locating method should be carefully determined. Shaft design examples for cylindrical bore bearings are given in Table 14-4, and those for bearings with a tapered bore in Table 14-5.

Table 14-4 Mounting designs for cylindrical bore bearings

(a) Shaft locknut	(b) End plate	(c) Locating snap ring
		
<p>Lockwashers are used to prevent loosening of locknuts. When tapered roller bearings or angular contact ball bearings are transition-fitted to shafts, plain washers several mm thick as shown above (at right) should be added and tightened with nut.</p>	<p>End of shaft should have bolt holes.</p>	<p>Used when the housing inside is limited, or to simplify shaft machining.</p>

Table 14-5 Mounting designs for bearings with tapered bore

(d) Adapter assembly	(e) Withdrawal sleeve	(f) Shaft locknut	(g) Split ring
			
<p>The simplest method for axial positioning is just to attach an adapter sleeve to the shaft and tighten the locknuts. To prevent locknut loosening, lock-washer (not more than 180 mm in shaft diameter) or lock plate (not less than 200 mm in shaft diameter) are used.</p>	<p>The locknut (above) or end plate (below) fixes the bearing with a withdrawal sleeve, which makes it easy to dismount the bearing.</p>	<p>The shaft is threaded in the same way as shown in Fig. (a). The bearing is located by tightening locknut.</p>	<p>A split ring with threaded outside diameter is inserted into groove on the tapered shaft. A key is often used to prevent the locknut and split ring from loosening.</p>

14-4 Sealing devices

Sealing devices not only prevent foreign matter (dirt, water, metal powder) from entering, but prevent lubricant inside from leaking. If the sealing device fails to function satisfactorily, foreign matter or leakage will cause bearing damage as a result of malfunction or seizure.

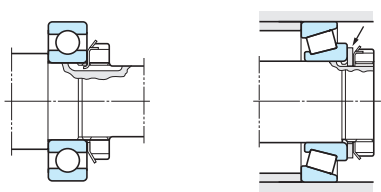
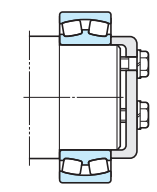
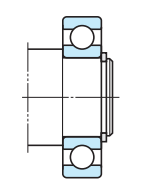
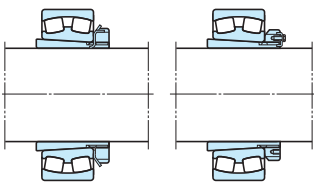
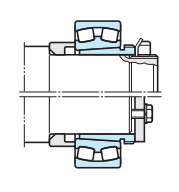
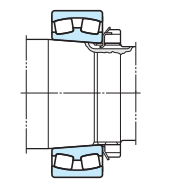
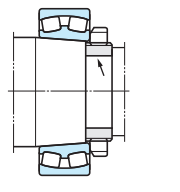
Therefore, it is necessary to design or choose the most suitable sealing devices as well as to choose the proper lubricating measures according to operating conditions.

Sealing devices may be divided into non-contact and contact types according to their structure.

They should satisfy the following conditions :

- Free from excessive friction (heat generation)
- Easy maintenance (especially ease of mounting and dismounting)
- As low cost as possible

14-4-1 Non-contact type sealing devices

A non-contact type sealing device, which includes oil groove, flinger (slinger), and labyrinth, eliminates friction because it does not have a contact point with the shaft.

These devices utilize narrow clearance and centrifugal force and are especially suitable for operation at high rotation speed and high temperature.

Table 14-6 (1) Non-contact type sealing devices

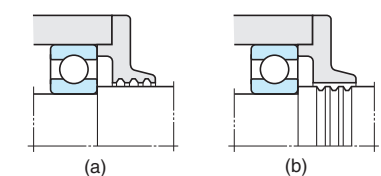
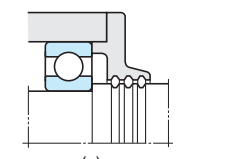
(1) Oil groove



■ This kind of seal having more than three grooves at the narrow clearance between the shaft and housing cover, is usually accompanied by other sealing devices except when it is used with grease lubrication at low rotation speed.

■ Preventing entrance of contaminants can be improved by filling the groove with calcium grease (cup grease) having a consistency of 150 to 200.

■ The clearance between the shaft and housing cover should be as narrow as possible. Recommended clearances are as follows.

- Shaft diameter of less than 50mm 0.25 – 0.4mm
- Shaft diameter of over 50mm 0.5 – 1 mm

■ Recommended dimensions for the oil groove are as follows.

- Width 2 – 5mm
- Depth 4 – 5mm

Table 14-6 (2) Non-contact type sealing devices

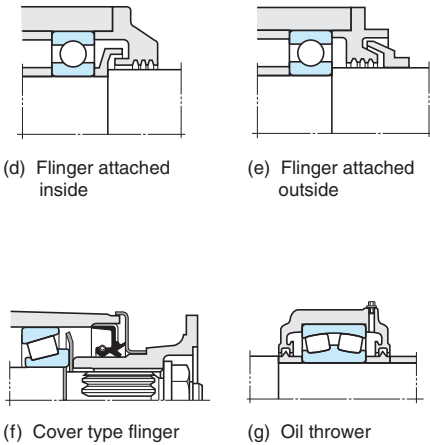
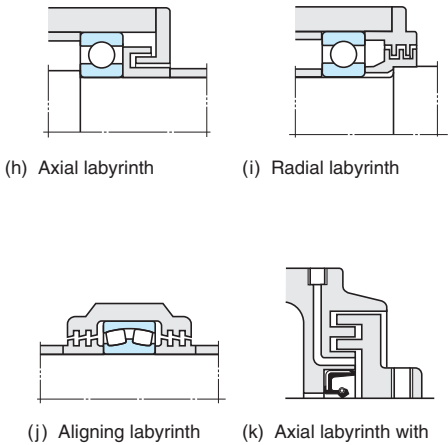
(2) Flinger (slinger)	(3) Labyrinth									
 <p>(d) Flinger attached inside (e) Flinger attached outside</p> <p>(f) Cover type flinger (g) Oil thrower</p>	 <p>(h) Axial labyrinth (i) Radial labyrinth</p> <p>(j) Aligning labyrinth (k) Axial labyrinth with greasing feature</p>									
<ul style="list-style-type: none"> ■ A flinger utilizes centrifugal force to splash away the oil and dirt. It produces an air stream which prevents oil leakage and dirt by a pumping action. In many cases, this device is used together with other sealing devices. ■ A flinger installed inside the housing (Fig. d) provides an inward pumping action, preventing lubricant leakage; and, when installed outside (Fig. e), the outward pumping action prevents lubricant contamination. ■ A cover type flinger (Fig. f) splashes away dirt and dust by centrifugal force. ■ The oil thrower, shown in (Fig. g), is a kind of flinger. An annular ridge on the shaft or a ring fitted onto the shaft utilizes centrifugal force to prevent the lubricant from flowing out. 	<ul style="list-style-type: none"> ■ A labyrinth provides clearance in the shape of engagements between the shaft and housing. It is the most suitable for prevention of lubricant leakage at high rotation speed. ■ Though an axial labyrinth, shown in (Fig. h), is popular because of its ease of mounting, the sealing effect is better in a radial labyrinth, shown in (Fig. i). ■ An aligning labyrinth (Fig. j) is used with self-aligning type bearings. ■ In the cases of (Fig. i) and (Fig. j), the housing or the housing cover should be split. ■ Recommended labyrinth clearances are given in the following table. <table border="1" style="width: 100%; border-collapse: collapse;"> <thead> <tr> <th style="text-align: left;">Shaft diameter</th> <th style="text-align: left;">Radial clearance</th> <th style="text-align: left;">Axial clearance</th> </tr> </thead> <tbody> <tr> <td>50mm or less</td> <td>0.25 – 0.4mm</td> <td>1 – 2mm</td> </tr> <tr> <td>Over 50mm</td> <td>0.5 – 1 mm</td> <td>3 – 5mm</td> </tr> </tbody> </table> <ul style="list-style-type: none"> ■ To improve sealing effect, fill the labyrinth clearance with grease, shown in (Fig. k). 	Shaft diameter	Radial clearance	Axial clearance	50mm or less	0.25 – 0.4mm	1 – 2mm	Over 50mm	0.5 – 1 mm	3 – 5mm
Shaft diameter	Radial clearance	Axial clearance								
50mm or less	0.25 – 0.4mm	1 – 2mm								
Over 50mm	0.5 – 1 mm	3 – 5mm								

14-4-2 Contact type sealing devices

This type provides a sealing effect by means of the contact of its end with the shaft and are manufactured from synthetic rubber, synthetic resin, or felt.

The synthetic rubber oil seal is most popular.

1) Oil seals

Many types and sizes of oil seals, as a finished part, have been standardized.

JTEKT produces various oil seals.

The names and functions of each oil seal part are shown in Fig. 14-8 and Table 14-7. Table 14-8 provides a representative example.

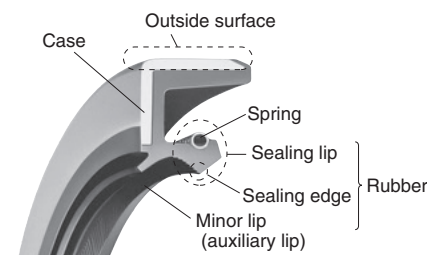







Fig. 14-8 Names of oil seal parts

Table 14-7 Complete list of oil seal part functions

Names	Functions
Sealing edge	Prevents fluid leakage by making contact with rotating shaft. <div style="border: 1px solid black; padding: 2px; margin-top: 5px;">The contact surface of the sealing edge with the shaft should always be filled with lubricant, so as to maintain an oil film therein.</div>
Sealing lip and spring	Provides proper pressure on the sealing edge to maintain stable contact. Spring provides proper pressure on the lip and maintains such pressure for a long time.
Outside surface	Fixes the oil seal to the housing and prevents fluid leakage through the fitting surface. <div style="border: 1px solid black; padding: 2px; margin-top: 5px;">Comes encased in metal cased type or rubber covered type.</div>
Case	Strengthens seal.
Minor lip (auxiliary lip)	Prevents entry of contaminants. <div style="border: 1px solid black; padding: 2px; margin-top: 5px;">In many cases, the space between the sealing lip and minor lip is filled with grease.</div>

Table 14-8 Typical oil seal types

With case		With inner case	Without case
Without spring	With spring		With spring
 HM (JIS GM) MH (JIS G)	 HMS (JIS SM) MHS (JIS S) CRS		 HMSH (JIS SA) MS
 HMA MHA	 HMSA (JIS DM) MHA (JIS D) CRSA		 HMSAH (JIS DA)

- The oil seals shown in the lower row contain the minor lip (auxiliary lip).
- Special types of seals such as the mud resistance seal, pressure resistance seal and outer seal for rotating housings can be provided to serve under various operating conditions.

- By providing a slit on the oil seals, it is possible to attach them from other points than the shaft ends.

Oil seals without minor lips are mounted in different directions according to their operating conditions (shown in Fig. 14-9).

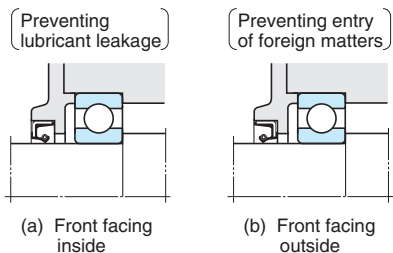

Fig. 14-9 Direction of sealing lips and their purpose

When the seal is used in a dirty operating environment, or penetration of water is expected, it is advisable to have two oil seals combined or to have the space between the two sealing lips be filled with grease.

(shown in Fig. 14-10)

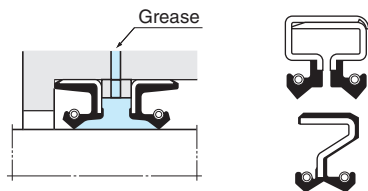

Fig. 14-10 Seals used in a dirty operating environment

Respective seal materials possess different properties. Accordingly, as shown in Table 14-9, allowable lip speed and operating temperature differ depending on the materials. Therefore, by selecting proper materials, oil seals can be used for sealing not only lubricants but also chemicals including alcohol, acids, alkali, etc.

Table 14-9 Allowable lip speed and operating temperature range of oil seals

Seal material	Allowable lip speed (m/s)	Operating temperature range (°C)
NBR	15	- 40 to + 120
Acrylic rubber	25	- 30 to + 150
Silicone rubber	32	- 50 to + 170
Fuoro rubber	32	- 20 to + 180

To ensure the maximum sealing effect of the oil seal, the shaft materials, surface roughness and hardness should be carefully chosen.

Table 14-10 shows the recommended shaft conditions.

Table 14-10 Recommended shaft conditions

Material	Machine structure steel, low alloy steel and stainless steel
Surface hardness	For low speed : harder than 30 HRC For high speed : harder than 50 HRC
Surface roughness (Ra)	0.2 – 0.6a A surface which is excessively rough may cause oil leakage or abrasion ; whereas an excessively fine surface may cause sealing lip seizure, preventing the oil film from forming. Surface must also be free of spiral grinding marks.

2) Felt seals and others

Although felt seals have been used conventionally, it is recommended to replace them with rubber oil seals because the use of felt seals are limited to the following conditions.

- Light dust protection
- Allowable lip speed : not higher than 5m/s

Contact type sealing devices include mechanical seals, O-rings and packings other than those described herein.

JTEKT manufactures various oil seals ranging from those illustrated in Table 14-8 to special seals for automobiles, large seals for rolling mills, mud resistance seals, pressure resistance seals, outer seals for rotating housings and O-rings.
For details, refer to JTEKT separate catalog "Oil seals & O-rings" (CAT. NO. R2001E).

15. Handling of bearings

15-1 General instructions

Since rolling bearings are more precisely made than other machine parts, careful handling is absolutely necessary.

- 1) Keep bearings and the operating environment clean.
- 2) Handle carefully.
Bearings can be cracked and brinelled easily by strong impact if handled roughly.
- 3) Handle using the proper tools.
- 4) Keep bearings well protected from rust. Do not handle bearings in high humidity. Operators should wear gloves in order not to soil bearings with perspiration from their hands.
- 5) Bearings should be handled by experienced or well trained operators.
- 6) Set bearing operation standards and follow them.
 - Storage of bearings
 - Cleaning of bearings and their adjoining parts.
 - Inspection of dimensions of adjoining parts and finish conditions
 - Mounting
 - Inspection after mounting
 - Dismounting
 - Maintenance and inspection (periodical inspection)
 - Replenishment of lubricants

Since the anti-corrosion oil covering bearings is a highly capable lubricant, the oil should not be cleaned off if the bearings are pre-lubricated, or when the bearings are used for normal operation. However, if the bearings are used in measuring instruments or at high rotation speed, the anti-corrosion oil should be removed using a clean detergent oil. After removal of the anti-corrosion oil, bearings should not be left for a long time because they rust easily.

2) Inspection of shafts and housings

Clean up the shaft and housing to check whether it has flaws or burrs as a result of machining.

Be very careful to completely remove lapping agents (SiC, Al₂O₃, etc.), casting sands, and chips from inside the housing.

Next, check that the dimensions, forms, and finish conditions of the shaft and the housing are accurate to those specified on the drawing.

The shaft diameter and housing bore diameter should be measured at the several points as shown in Figs. 15-1 and 15-2.

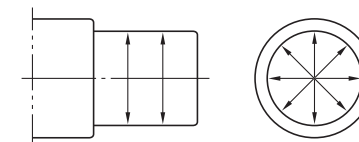

Fig. 15-1 Measuring points on shaft diameter

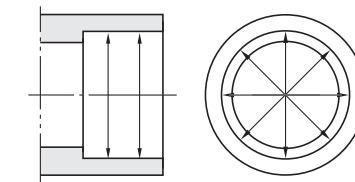

Fig. 15-2 Measuring points on housing bore diameter

15-2 Storage of bearings

In shipping bearings, since they are covered with proper anti-corrosion oil and are wrapped in antitarnish paper, the quality of the bearings is guaranteed as long as the wrapping paper is not damaged.

If bearings are to be stored for a long time, it is advisable that the bearings be stored on shelves set higher than 30 cm from the floor, at a humidity less than 65 %, and at a temperature around 20°C.

Avoid storage in places exposed directly to the sun's rays or placing boxes of bearings against cold walls.

15-3 Bearing mounting

15-3-1 Recommended preparation prior to mounting

1) Preparation of bearings

Wait until just before mounting before removing the bearings from their packaging to prevent contamination and rust.

Furthermore, fillet radius of shaft and housing, and the squareness of shoulders should be checked.

When using shaft and housing which have passed inspection, it is advisable to apply machine oil to each fitting surface just before mounting.

15-3-2 Bearing mounting

Mounting procedures depend on the type and fitting conditions of bearings.

For general bearings in which the shaft rotates, an interference fit is applied to inner rings, while a clearance fit is applied to outer rings.

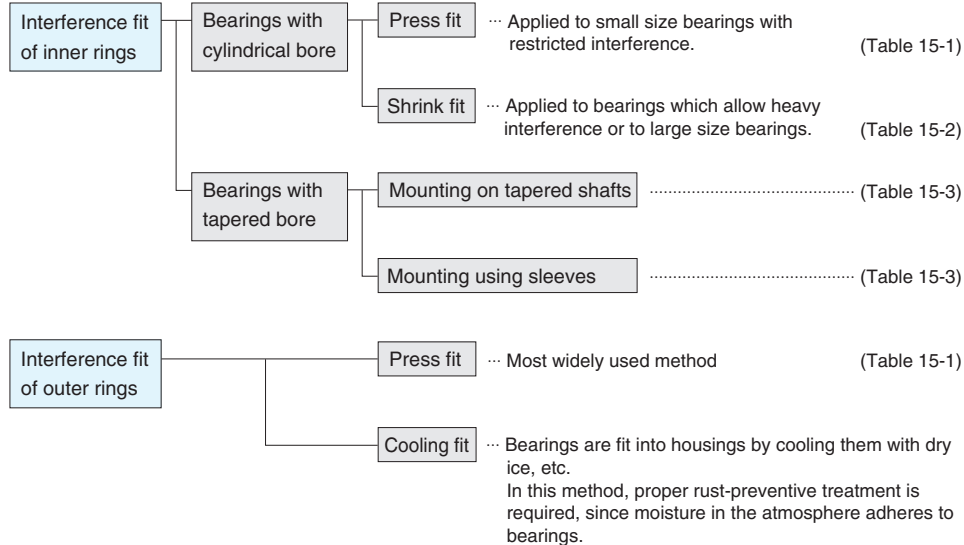

For bearings in which the outer rings rotate, an interference fit is applied to the outer rings.

Interference fitting is roughly classified as shown here. The detailed mounting processes are described in Tables 15-1 to 15-3.

Table 15-1 Press fit of bearings with cylindrical bores

Mounting methods	Descriptions
<p>(a) Using press fit (the most widely used method)</p>	<p>■ As shown in the Fig., a bearing should be mounted slowly with care, by using a fixture to apply force evenly to the bearing. When mounting the inner ring, apply pressure to the inner ring only. Similarly, in mounting the outer ring, press only the outer ring.</p> <p>(Inner ring press fit) (Outer ring press fit) (Inner ring press fit)</p> <p>■ If interference is required on both the inner and outer ring of non-separable bearings, use two kinds of fixtures as shown in the Fig. and apply force carefully, as rolling elements are easily damaged. Be sure never to use a hammer in such cases.</p> <p>Simultaneous press fit of inner ring and outer ring</p>
<p>(b) Using bolts and nuts</p> <p>(screw hole should be provided at the shaft end)</p>	
<p>(c) Using hammers</p> <p>(only when there is no alternative measure)</p>	

Reference Force is necessary to press fit or remove bearings.

The force necessary to press fit or remove inner rings of bearings differs depending on the finish of shafts and how much interference the bearings allow.

The standard values can be obtained by using the following equations.

(Solid shafts) $K_a = 9.8 f_k \cdot \Delta_{def} \cdot B \left(1 - \frac{d^2}{D_i^2} \right) \times 10^3$ (15-1)

(Hollow shafts) $K_a = 9.8 f_k \cdot \Delta_{def} \cdot B \frac{\left(1 - \frac{d^2}{D_i^2} \right) \left(1 - \frac{d_0^2}{d^2} \right)}{\left(1 - \frac{d_0^2}{D_i^2} \right)} \times 10^3$ (15-2)



In equations (15-1) and (15-2),

- K_a : force necessary for press fit or removal N
- Δ_{def} : effective interference mm
- f_k : resistance coefficient
- [Coefficient taking into consideration friction between shafts and inner rings ... refer to the table on the right]
- B : nominal inner ring width mm
- d : nominal inner ring bore diameter mm
- D_i : average outside diameter of inner ring mm
- d_0 : hollow shaft bore diameter mm

Value of resistance coefficient f_k

Conditions	f_k
· Press fitting bearings on to cylindrical shafts	4
· Removing bearings from cylindrical shafts	6
· Press fitting bearings on to tapered shafts or tapered sleeves	5.5
· Removing bearings from tapered shafts or tapered sleeves	4.5
· Press fitting tapered sleeves between shafts and bearings	10
· Removing tapered sleeves from the space between shafts and bearings	11

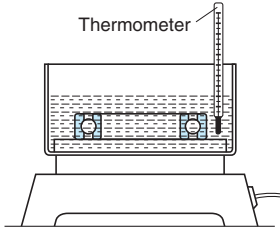
Table 15-2 Shrink fit of cylindrical bore bearings

Shrink fit	Descriptions
 <p>(a) Heating in an oil bath</p>	<ul style="list-style-type: none"> ■ This method, which expands bearings by heating them in oil, has the advantage of not applying too much force to bearings and taking only a short time. <p>[Notes]</p> <ul style="list-style-type: none"> ● Oil temperature should not be higher than 100 °C, because bearings heated at higher than 120 °C lose hardness. ● Heating temperature can be determined from the bore diameter of a bearing and the interference by referring to Fig. 15-3. ● Use nets or a lifting device to prevent the bearing from resting directly on the bottom of the oil container. ● Since bearings shrink in the radial direction as well as the axial direction while cooling down, fix the inner ring and shaft shoulder tightly with the shaft nut before shrinking, so that no space is left between them. <p>■ Shrink fit proves to be clean and effective since, by this method, the ring can be provided with even heat in a short time using neither fire nor oil.</p> <p>(When electricity is being conducted, the bearing itself generates heat by its electrical resistance, aided by the built-in exciting coil.)</p>
 <p>(b) Induction heater</p>	

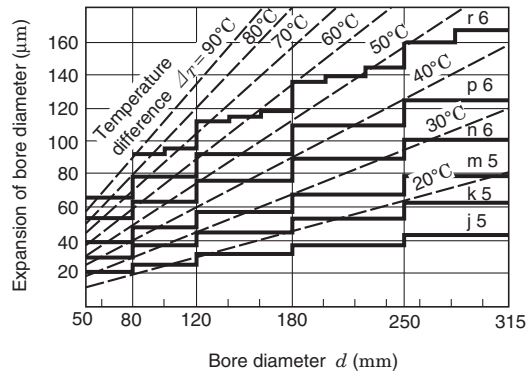

Fig. 15-3 Heating temperature and expansion of inner rings

[Remarks]

1. Thick solid lines show the maximum interference value between bearings (class 0) and shafts (r 6, p 6, n 6, m 5, k 5, j 5) at normal temperature.
 2. Therefore, the heating temperature should be selected to gain a larger "expansion of the bore diameter" than the maximum interference values.
- (When fitting class 0 bearings having a 90 mm bore diameter to m 5 shafts, this figure shows that heating temperature should be 40 °C higher than room temperature to produce expansion larger than the maximum interference value of 48 µm.
- However, taking cooling during mounting into consideration, the temperature should be set 20 to 30 °C higher than the temperature initially required.

Table 15-3 Mounting bearings with tapered bores

Mounting methods	Descriptions
 <p>① Locknut</p>  <p>② Hydraulic nut</p> <p>(a) Mounting on tapered shafts</p>	<ul style="list-style-type: none"> ■ When mounting bearings directly on tapered shafts, provide oil holes and grooves on the shaft and inject high pressure oil into the space between the fitting surfaces (oil injection). Such oil injection can reduce tightening torque of locknut by lessening friction between the fitting surfaces. ■ When exact positioning is required in mounting a bearing on a shaft with no shoulder, use a clamp to help determine the position of the bearing.  <p>Locating bearing by use of a clamp</p> <ul style="list-style-type: none"> ■ When mounting bearings on shafts, locknuts are generally used. Special spanners are used to tighten them. Bearings can also be mounted using hydraulic nuts.  <p>special spanner</p> <ul style="list-style-type: none"> ■ When mounting tapered bore spherical roller bearings, the reduction in the radial internal clearance which gradually occurs during operation should be taken into consideration as well as the push-in depth described in Table 15-4. <p>Clearance reduction can be measured by a thickness gage. First, stabilize the roller in the proper position and then insert the gage into the space between the rollers and the outer ring. Be careful that the clearance between both roller rows and the outer rings is roughly the same ($e \approx e'$). Since the clearance may differ at different measuring points, take measurements at several positions.</p> <ul style="list-style-type: none"> ■ When mounting self-aligning ball bearings, leave enough clearance to allow easy aligning of the outer ring.
 <p>① Locknut</p>  <p>② Hydraulic nut</p> <p>(b) Mounting by use of an adapter sleeve</p>	
 <p>① Locknut</p>  <p>② Hydraulic nut</p> <p>(c) Mounting by use of a withdrawal sleeve</p>	
 <p>(d) Measuring clearances</p>	

Table 15-4 Mounting tapered bore spherical roller bearings

Nominal bore diameter d mm		Reduction of radial internal clearance μm		Axial displacement, mm				Minimum required residual clearance, μm		
				1/12 taper		1/30 taper		C N clearance	C 3 clearance	C 4 clearance
over	up to	min.	max.	min.	max.	min.	max.			
24	30	15	20	0.27	0.35	—	—	10	20	35
30	40	20	25	0.32	0.4	—	—	15	25	40
40	50	25	35	0.4	0.5	—	—	20	30	45
50	65	30	40	0.45	0.6	—	—	25	35	55
65	80	35	50	0.55	0.75	—	—	35	40	70
80	100	40	55	0.65	0.85	—	—	40	50	85
100	120	55	70	0.85	1.05	2.15	2.65	45	65	100
120	140	65	90	1.0	1.2	2.5	3.0	55	80	110
140	160	75	100	1.1	1.35	2.75	3.4	55	90	130
160	180	80	110	1.2	1.5	3.0	3.8	60	100	150
180	200	90	120	1.4	1.7	3.5	4.3	70	110	170
200	225	100	130	1.55	1.85	3.85	4.6	80	120	190
225	250	110	140	1.7	2.05	4.25	5.1	90	130	210
250	280	120	160	1.8	2.3	4.5	5.75	100	140	230
280	315	130	180	2.0	2.5	5.0	6.25	110	150	250
315	355	150	200	2.3	2.8	5.75	7.0	120	170	270
355	400	170	220	2.5	3.1	6.25	7.75	130	190	300
400	450	190	240	2.8	3.4	7.0	8.5	140	210	330
450	500	210	270	3.1	3.8	7.75	9.5	160	230	360
500	560	240	310	3.5	4.3	8.75	10.8	170	260	370
560	630	260	350	3.9	4.8	9.75	12.0	200	300	410
630	710	300	390	4.3	5.3	10.8	13.3	210	320	460
710	800	340	430	4.8	6.0	12.0	15.0	230	370	530
800	900	370	500	5.3	6.7	13.3	16.8	270	410	570
900	1000	410	550	5.9	7.4	14.8	18.5	300	450	640

[Remark] The values for reduction of radial internal clearance listed above are values obtained when mounting bearings with CN clearance on solid shafts. In mounting bearings with C 3 clearance, the maximum value listed above should be taken as the standard.

15-4 Test run

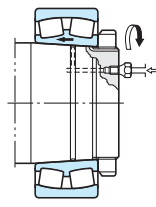
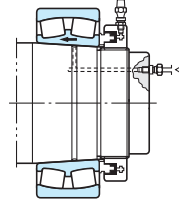
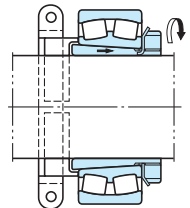
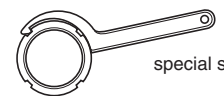
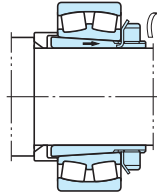
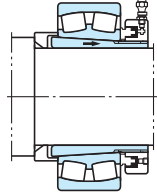
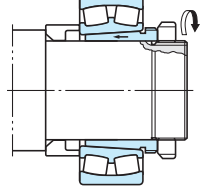
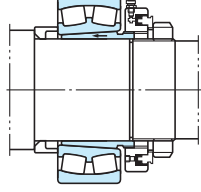
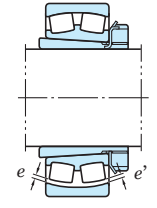
A trial operation is conducted to insure that the bearings are properly mounted.

In the case of compact machines, rotation may be checked by manual operation at first.

If no abnormalities, such as those described below, are observed, then further trial operation proceeds using a power source.

- Knocking ... due to flaws or insertion of foreign matter on rolling contact surfaces.
- Excessive torque (heavy) ... due to friction on sealing devices, too small clearances, and mounting errors.

- Uneven running torque ... due to improper mounting and mounting errors.

For machines too large to allow manual operation, idle running is performed by turning off the power source immediately after turning it on. Before starting power operation, it must be confirmed that bearings rotate smoothly without any abnormal vibration and noise.

Power operation should be started under no load and at low speed, then the speed is gradually increased until the designed speed is reached.

During power operation, check the noise, increase in temperature and vibration.

If any of the abnormalities listed in Tables 15-5 and 15-6 are found, operation must be

stopped, and inspection for defects immediately conducted.

The bearings should be dismantled if necessary.

Table 15-5 Bearing noises, causes, and countermeasures

Noise types		Causes	Countermeasures
Cyclic	Flaw noise (similar to noise when punching a rivet) Rust noise Brinelling noise (Unclear siren-like noise)	Flaw on raceway Rust on raceway Brinelling on raceway	Improve mounting procedure, cleaning method and rust preventive method. Replace bearing.
	Flaking noise (similar to a large hammering noise)	Flaking on raceway	Replace bearing.
Not cyclic	Dirt noise (an irregular sandy noise.)	Insertion of foreign matter	Improve cleaning method, sealing device. Use clean lubricant. Replace bearing.
	Fitting noise (drumming or hammering noise)	Improper fitting or excessive bearing clearance	Review fitting and clearance conditions. Provide preload. Improve mounting accuracy.
	Flaw noise, rust noise, flaking noise	Flaws, rust and flaking on rolling elements	Replace bearing.
	Squeak noise (often heard in cylindrical roller bearings with grease lubrication, especially in winter or at low temperatures)	If noise is caused by improper lubrication, a proper lubricant should be selected. In general, however, serious damage will not be caused by an improper lubricant if used continuously.	
Others	Abnormally large metallic sound	Abnormal load Incorrect mounting Insufficient amount of or improper lubricant	Review fitting, clearance. Adjust preload. Improve accuracy in processing and mounting shafts and housings. Improve sealing device. Refill lubricant. Select proper lubricant.

Table 15-6 Causes and countermeasures for abnormal temperature rise

Causes	Countermeasures
Too much lubricant	Reduce lubricant amount. Use grease of lower consistency.
Insufficient lubricant	Refill lubricant.
Improper lubricant	Select proper lubricant.
Abnormal load	Review fitting and clearance conditions and adjust preload.
Improper mounting (excessive friction)	Improve accuracy in processing and mounting shaft and housing. Review fitting. Improve sealing device.

Normally, listening rods are employed for bearing noise inspections.

The instrument detecting abnormalities through sound vibration and the Diagnosis System utilizing acoustic emission for abnormality detection are also applicable.

In general, bearing temperature can be estimated from housing temperature, but the most accurate method is to measure the temperature of outer rings directly via lubrication holes.

Normally, bearing temperature begins to rise gradually when operation is just starting; and, unless the bearing has some abnormality, the temperature stabilizes within one or two hours.

Therefore, a rapid rise in temperature or unusually high temperature indicates some abnormality.

15-5 Bearing dismantling

After dismantling bearings, handling of the bearings and the various methods available for this should be considered.

If the bearing is to be disposed of, any simple method such as torch cutting can be employed. If the bearing is to be reused or checked for the causes of its failure, the same amount of care as in mounting should be taken in dismantling so as not to damage the bearing and other parts.

Since bearings with interference fits are easily damaged during dismantling, measures to prevent damage during dismantling must be incorporated into the design.

It is recommended that dismantling devices be designed and manufactured, if necessary.

It is useful for discovering the causes of failures when the conditions of bearings, including mounting direction and location, are recorded prior to dismantling.

Dismantling method

Tables 15-7 to 15-9 describe dismantling methods for interference fit bearings intended for reuse or for failure analysis.

The force necessary to remove bearings can be calculated using the equations given on page A 142.

Table 15-7 Dismantling of cylindrical bore bearings

Inner ring dismantling methods	Descriptions
 <p>(a) Dismounting by use of a press</p>	<ul style="list-style-type: none"> • Non-separable bearings should be treated carefully during dismantling so as to minimize external force, which affects their rolling elements. • The easiest way to remove bearings is by using a press as shown in Fig. (a). It is recommended that the fixture be prepared so that the inner ring can receive the removal force. • Figs. (b) and (c) show a dismantling method in which special tools are employed. In both cases, the jaws of the tool should firmly hold the side of the inner ring. • Fig. (d) shows an example of removal by use of an induction heater : this method can be adapted to both mounting and dismantling of the inner rings of NU and NJ type cylindrical roller bearings. The heater can be used for heating and expanding inner rings in a short time.
 <p>(b) Dismounting by use of special tools</p>	
 <p>(c) Dismounting by use of special tools</p>	
 <p>(d) Dismounting using induction heater</p>	

Table 15-8 Dismounting tapered bore bearings

Inner ring dismantling methods	Descriptions
 <p>(a) Dismounting by use of a wedge</p>	<ul style="list-style-type: none"> • Fig. (a) shows the dismantling of an inner ring by means of driving wedges into notches at the back of the labyrinth. Fig. (b) shows dismantling by means of feeding high pressure oil to the fitting surfaces. In both cases, it is recommended that a stopper (ex. shaft nuts) be provided to prevent bearings from suddenly dropping out. • For bearings with an adapter sleeve, the following two methods are suitable. As shown in Fig. (c), fix bearings with clamps, loosen locknuts, then hammer off the adapter sleeve. This method is mainly used for small size bearings. Fig. (d) shows the method using hydraulic nuts. • Small size bearings with withdrawal sleeves can be removed by tightening locknuts as shown in Fig. (e). For large size bearings, provide several bolt holes on locknuts as shown in Fig. (f), and tighten bolts. The bearings can then be removed as easily as small size bearings. • Fig. (g) shows the method using hydraulic nuts.
 <p>(b) Dismounting by use of oil pressure</p>	
 <p>(c) Dismounting by use of clamps</p>	
 <p>(d) Dismounting by use of hydraulic nuts</p>	
 <p>(e) Dismounting by use of locknuts</p>	
 <p>(f) Dismounting by use of bolts</p>	
 <p>(g) Dismounting by use of hydraulic nuts</p>	

Table 15-9 Dismounting of outer rings

Outer ring dismantling methods	Description
 <p>(a) Notches for dismantling</p>	<ul style="list-style-type: none"> • To dismantle outer rings with interference fits, it is recommended that notches or bolt holes be provided on the shoulder of the housings.
 <p>(b) Bolt holes and bolts for dismantling</p>	

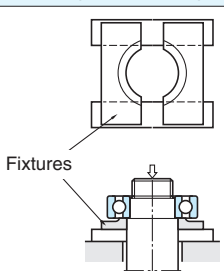
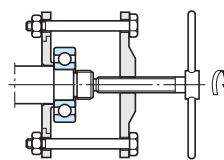
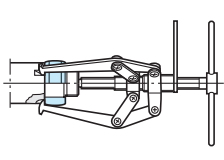
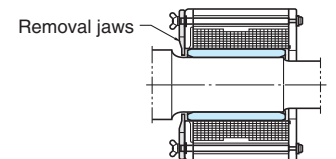
15-6 Maintenance and inspection of bearings

Periodic and thorough maintenance and inspection are indispensable to drawing full performance from bearings and lengthening their useful life.

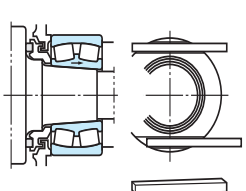
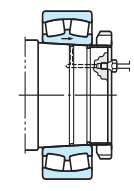
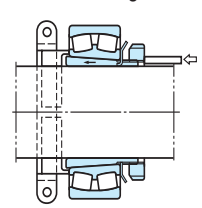
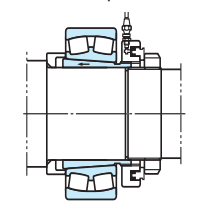
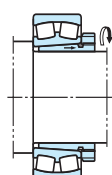
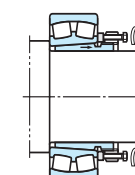
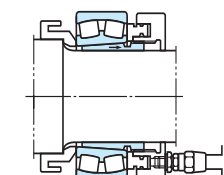
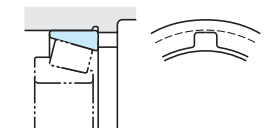
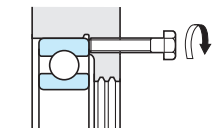
Besides, prevention of accidents and down time by early detection of failures through maintenance and inspection greatly contributes to the enhancement of productivity and profitability.

15-6-1 Cleaning

Before dismantling a bearing for inspection, record the physical condition of the bearing, including taking photographs.

Cleaning should be done after checking the amount of remaining lubricant and collecting lubricant as a sample for examination.

- A dirty bearing should be cleaned using two cleaning processes, such as rough cleaning and finish cleaning.
It is recommended that a net be set on the bottom of cleaning containers.
- In rough cleaning, use brushes to remove grease and dirt. Bearings should be handled carefully. Note that raceway surfaces may be damaged by foreign matter, if bearings are rotated in cleaning oil.
- During finish cleaning, clean bearings carefully by rotating them slowly in cleaning oil.

In general, neutral water-free light oil or kerosene is used to clean bearings, a warm alkali solution can also be used if necessary. In any case, it is essential to keep oil clean by filtering it prior to cleaning.

Apply anti-corrosion oil or rust preventive grease on bearings immediately after cleaning.

15-6-2 Inspection and analysis

Before determining that dismantled bearings will be reused, the accuracy of their dimensions and running, internal clearance, fitting surfaces, raceways, rolling contact surfaces, cages and seals must be carefully examined, so as to confirm that no abnormality is present.

It is desirable for skilled persons who have sufficient knowledge of bearings to make decisions on the reuse of bearings.

Criteria for reuse differs according to the performance and importance of machines and inspection frequency.

If the following defects are found, replace the bearing with a new one.

- Cracks and chips in bearing components
- Flaking on the raceway surfaces and the rolling contact surfaces
- Other failures of a serious degree described in the following section "16. Examples of bearing failures."

15-7 Methods of analyzing bearing failures

It is important for enhancing productivity and profitability, as well as for accident prevention that abnormalities in bearings are detected during operation.

Representative detection methods are described in the following section.

1) Noise checking

Since the detection of abnormalities in bearings from noises requires ample experience, sufficient training must be given to inspectors. Given this, it is recommended that specific persons be assigned to this work in order to gain this experience.

Attaching hearing aids or listening rods on housings is effective for detecting bearing noise.

2) Checking of operating temperature

Since this method utilizes change in operating temperature, its application is limited to relatively stable operations.

For detection, operating temperatures must be continuously recorded.

If abnormalities occur in bearings, operating temperature not only increase but also change irregularly.

It is recommended that this method be employed together with noise checking.

3) Lubricant checking

This method detects abnormalities from the foreign matter, including dirt and metallic powder, in lubricants collected as samples.

This method is recommended for inspection of bearings which cannot be checked by close visual inspection, and large size bearings.

16. Examples of bearing failures

Table 16-1 (1) Bearing failures, causes and countermeasures





Failures	Characteristics		Damages	Causes	Countermeasures
1 Flaking	 (A-6961)  (A-6476) <p>Flaking is a phenomenon when material is removed in flakes from a surface layer of the bearing raceways or rolling elements due to rolling fatigue.</p> <p>This phenomenon is generally attributed to the approaching end of bearing service life. However, if flaking occurs at early stages of bearing service life, it is necessary to determine causes and adopt countermeasures.</p> <p>[Reference] Pitting Pitting is another type of failure caused by rolling fatigue, in which minute holes of approx. 0.1 mm in depth are generated on the raceway surface.</p>		Flaking occurring at an incipient stage	<ul style="list-style-type: none"> Too small internal clearance Improper or insufficient lubricant Too much load Rust 	<ul style="list-style-type: none"> Provide proper internal clearance. Select proper lubricating method or lubricant.
		Flaking on one side of radial bearing raceway	<ul style="list-style-type: none"> Extraordinarily large axial load 	<ul style="list-style-type: none"> Fitting between outer ring on the free side and housing should be changed to clearance fit. 	
		Symmetrical flaking along circumference of raceway	<ul style="list-style-type: none"> Inaccurate housing roundness 	<ul style="list-style-type: none"> Correct processing accuracy of housing bore. (Especially for split housings, care should be taken to ensure processing accuracy.) 	
		Slanted flaking on the radial ball bearing raceway	<ul style="list-style-type: none"> Improper mounting Shaft deflection Inaccuracy of the shaft and housing 	<ul style="list-style-type: none"> Correct centering. Widen bearing internal clearance. Correct squareness of shaft or housing shoulder. 	
		Flaking occurring near the edge of the raceway or rolling contact surface of roller bearings			
Flaking on the raceway surface at the same interval as rolling element spacing		<ul style="list-style-type: none"> Heavy impact load during mounting A flaw of cylindrical roller bearings or tapered roller bearings caused when they are mounted. Rust gathered while out of operation 	<ul style="list-style-type: none"> Improve mounting procedure. Provide rust prevention treatment before long cessation of operation. 		
2 Cracking, chipping	 (A-6395)		Cracking in outer ring or inner ring	<ul style="list-style-type: none"> Excessive interference Excessive fillet on shaft or housing Heavy impact load Advanced flaking or seizure 	<ul style="list-style-type: none"> Select proper fit. Adjust fillet on the shaft or in the housing to smaller than that of the bearing chamfer dimension. Re-examine load conditions.
			Cracking on rolling elements	<ul style="list-style-type: none"> Heavy impact load Advanced flaking 	<ul style="list-style-type: none"> Improve mounting and handling procedure. Re-examine load conditions.
			Cracking on the rib	<ul style="list-style-type: none"> Impact on rib during mounting Excessive axial impact load 	<ul style="list-style-type: none"> Improve mounting procedure. Re-examine load conditions.
3 Brinelling, nicks	 (A-6617) <p>(Brinelling)</p> <ul style="list-style-type: none"> Brinelling is a small surface indentation generated either on the raceway through plastic deformation at the contact point between the raceway and rolling elements, or on the rolling surfaces from insertion of foreign matter, when heavy load is applied while the bearing is stationary or rotating at a low rotation speed. Nicks are those indentations produced directly by rough handling such as hammering. 		Brinelling on the raceway or rolling contact surface	<ul style="list-style-type: none"> Entry of foreign matter 	<ul style="list-style-type: none"> Clean bearing and its peripheral parts. Improve sealing devices.
			Brinelling on the raceway surface at the same interval as the rolling element spacing	<ul style="list-style-type: none"> Impact load during mounting Excessive load applied while bearing is stationary 	<ul style="list-style-type: none"> Improve mounting procedure. Improve machine handling.
			Nicks on the raceway or rolling contact surface	<ul style="list-style-type: none"> Careless handling 	<ul style="list-style-type: none"> Improve mounting and handling procedure.

Table 16-1 (2) Bearing failures, causes and countermeasures









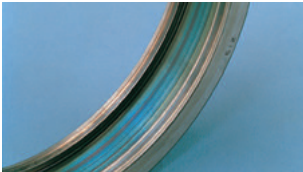

Failures	Characteristics		Damages	Causes	Countermeasures
④ Pear skin, discoloration  (A-6720) (Discoloration)	<ul style="list-style-type: none"> • Pear skin is a phenomenon in which minute brinell marks cover the entire rolling surface, caused by the insertion of foreign matter. This is characterized by loss of luster and a rolling surface that is rough in appearance. • In extreme cases, this is accompanied by discoloration due to heat generation. • Discoloration is a phenomenon in which the surface color changes because of staining or heat generation during rotation. • Color change caused by rust and corrosion is generally separate from this phenomenon. 		Indentation similar to pear skin on the raceway and rolling contact surface.	<ul style="list-style-type: none"> • Entry of minute foreign matter 	<ul style="list-style-type: none"> • Clean the bearing and its peripheral parts. • Improve sealing device.
			Discoloration of the raceway, surface rolling contact surface, rib face, and cage riding land.	<ul style="list-style-type: none"> • Too small bearing internal clearance • Improper or insufficient lubricant • Quality deterioration of lubricant due to aging, etc. 	<ul style="list-style-type: none"> • Provide proper internal clearance. • Select proper lubricating method or lubricant.
⑤ Scratches, scuffing  (A-6459) (Scuffing)	<ul style="list-style-type: none"> • Scratches are relatively shallow marks generated by sliding contact, in the same direction as the sliding. This is not accompanied by apparent melting of material. • Scuffing refers to marks, the surface of which are partially melted due to higher contact pressure and therefore a greater heat effect. • Generally, scuffing may be regarded as a serious case of scratches. 		Scratches on raceway or rolling contact surface	<ul style="list-style-type: none"> • Insufficient lubricant at initial operation • Careless handling 	<ul style="list-style-type: none"> • Apply lubricant to the raceway and rolling contact surface when mounting. • Improve mounting procedure.
			Scuffing on rib face and roller end face	<ul style="list-style-type: none"> • Improper or insufficient lubricant • Improper mounting • Excessive axial load 	<ul style="list-style-type: none"> • Select proper lubricating method or lubricant. • Correct centering of axial direction.
⑥ Smearing  (A-6640)	Smearing is a phenomenon in which a cluster of minute seizures cover the rolling contact surface. Since smearing is caused by high temperature due to friction, the surface of the material usually melts partially; and, the smeared surfaces appear very rough in many cases.		Smearing on raceway or rolling contact surface	<ul style="list-style-type: none"> • Improper or insufficient lubricant • Slipping of the rolling elements <p style="border: 1px solid black; padding: 5px; margin: 5px 0;"> This occurs due to the breakdown of lubricant film when an abnormal self rotation causes slip of the rolling elements on the raceway. </p>	<ul style="list-style-type: none"> • Select proper lubricating method or lubricant. • Provide proper preload.
⑦ Rust, corrosion  (A-7130)	<ul style="list-style-type: none"> • Rust is a film of oxides, or hydroxides, or carbonates formed on a metal surface due to chemical reaction. • Corrosion is a phenomenon in which a metal surface is eroded by acid or alkali solutions through chemical reaction (electrochemical reaction such as chemical combination and battery formation); resulting in oxidation or dissolution. It often occurs when sulfur or chloride contained in the lubricant additives is dissolved at high temperature. 		Rust partially or completely covering the bearing surface.	<ul style="list-style-type: none"> • Improper storage condition • Dew formation in atmosphere 	<ul style="list-style-type: none"> • Improve bearing storage conditions. • Improve sealing devices. • Provide rust preventive treatment before long cessation of operation.
			Rust and corrosion at the same interval as rolling element spacing	<ul style="list-style-type: none"> • Contamination by water or corrosive matter 	<ul style="list-style-type: none"> • Improve sealing devices.
⑧ Electric pitting  (A-6652)	When an electric current passes through a bearing while in operation, it can generate sparks between the raceway and rolling elements through a very thin oil film, resulting in melting of the surface metal in this area. This phenomenon appears to be pitting at first sight. (The resultant flaw is referred to as a pit.) When the pit is magnified, it appears as a hole like a crater, indicating that the material melted when it was sparking. In some cases, the rolling surface becomes corrugated by pitting.		Pitting or a corrugated surface failure on raceway and rolling contact surface	<ul style="list-style-type: none"> • Sparks generated when electric current passes through bearings <p style="border: 1px solid black; padding: 5px; margin: 5px 0;"> The bearings must be replaced, if the corrugated texture is found by scratching the surface with a fingernail or if pitting can be observed by visual inspection. </p>	<ul style="list-style-type: none"> • Providing a bypass which prevents current from passing through bearings. • Insulation of bearings.

Table 16-1 (3) Bearing failures, causes and countermeasures

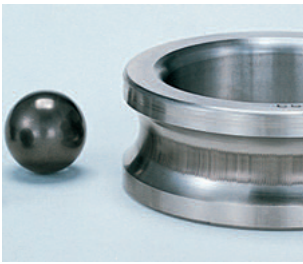
Failures	Characteristics		Damages	Causes	Countermeasures
9 Wear	 <p>(A-4719)</p> <p>Normally, wear of bearing is observed on sliding contact surfaces such as roller end faces and rib faces, cage pockets, the guide surface of cages and cage riding lands. Wear is not directly related to material fatigue. Wear caused by foreign matter and corrosion can affect not only sliding surfaces but rolling surfaces.</p>		<p>Wear on the contact surfaces (roller end faces, rib faces, cage pockets)</p> <p>Wear on raceways and rolling contact surfaces</p>	<p>Improper or insufficient lubricant</p> <p>· Entry of foreign matter · Improper or insufficient lubricant</p>	<p>· Select proper lubricating method or lubricant. · Improve sealing device. · Clean the bearing and its peripheral parts.</p>
10 Fretting	 <p>(A-6649)</p> <p>Fretting occurs to bearings which are subject to vibration while in stationary condition or which are exposed to minute vibration. It is characterized by rust-colored wear particles. Since fretting on the raceways often appears similar to brinelling, it is sometimes called "falsebrinelling".</p>		<p>Rust-colored wear particles generated on the fitting surface (fretting corrosion)</p> <p>Brinelling on the raceway surface at the same interval as rolling element spacing (false brinelling)</p>	<p>· Insufficient interference</p> <p>· Vibration and oscillation when bearings are stationary.</p>	<p>· Provide greater interference · Apply lubricant to the fitting surface</p> <p>· Improve fixing method of the shaft and housing. · Provide preload to bearing.</p>
11 Creeping	 <p>(A-6647)</p> <p>Creeping is a phenomenon in which bearing rings move relative to the shaft or housing during operation.</p>		<p>Wear, discoloration and scuffing, caused by slipping on the fitting surfaces</p>	<p>· Insufficient interference · Insufficient tightening of sleeve</p>	<p>· Provide greater interference. · Proper tightening of sleeve.</p>
12 Damage to cages	 <p>(A-6455)</p> <p>Since cages are made of low hardness materials, external pressure and contact with other parts can easily produce flaws and distortion. In some cases, these are aggravated and become chipping and cracks. Large chipping and cracks are often accompanied by deformation, which may reduce the accuracy of the cage itself and may hinder the smooth movement of rolling elements.</p>		<p>Flaws, distortion, chipping, cracking and excessive wear in cages. Loose or damaged rivets.</p>	<p>· Extraordinary vibration, impact, moment · Improper or insufficient lubricant · Improper mounting (misalignment) · Dents made during mounting</p>	<p>· Re-examine load conditions. · Select proper lubricating method or lubricant. · Minimize mounting deviation. · Re-examine cage types. · Improve mounting.</p>
13 Seizure	 <p>(A-6679)</p> <p>A phenomenon caused by abnormal heating in bearings.</p>		<p>Discoloration, distortion and melting together</p>	<p>· Too small internal clearance · Improper or insufficient lubricant · Excessive load · Aggravated by other bearing flaws</p>	<p>· Provide proper internal clearance. · Select proper lubricating method or lubricant. · Re-examine bearing type. · Earlier discovery of bearing flaws.</p>

Bearing specification tables

Contents

Standard bearings

Deep groove ball bearings B 4

- Single-row
 - Open type..... B 8
 - Shielded/sealed type B 20
 - Snap ring groove/
locating snap ring type B 32
- Extra-small, miniature ball bearings
 - Open/shielded/sealed type..... B 40
 - Flanged type (open/shielded type)... B 46
- Double-row B 52

Angular contact ball bearings B 54

- Single-row B 62
- Matched pair B 90
- Double-row B 118

Self-aligning ball bearings B 124

- Open type B 126
- Sealed type B 132
- Extended inner ring type B 134
- Adapter assemblies for self-aligning ball bearings ... B 136

Cylindrical roller bearings B 138

- Single-row B 142
- Thrust collars B 168
- Double-row B 178

Tapered roller bearings B 184

- Single-row
 - Metric series B 194
 - Inch series B 224
- Double-row
 - TDO type B 268
 - TDI type..... B 284

Spherical roller bearings B 290

- Spherical roller bearings B 294
- Adapter assemblies
for spherical roller bearings B 318
- Withdrawal sleeves
for spherical roller bearings B 326

Thrust ball bearings B 336

- Single direction B 338
- Double direction B 348

Spherical thrust roller bearings B 354

Needle roller bearings B 362

- Needle roller and cage assemblies... B 380
- Drawn cup type B 414
- Heavy-duty type B 432
- Thrust B 444
- Combined B 460
- Inner ring B 466
- (Miniature one-way clutches) B 482

[Introduction]

Ball bearing units B 486

Special purpose bearings

K-series super thin section ball bearings C 1

- Deep groove type } C 9
- Angular contact type } C 9
- Four-point contact type } C 9
- Sealed type C 19

Bearings for railway rolling stock axle journals C 21

- Cylindrical roller bearings C 25
- Sealed type cylindrical roller bearings C 27
- Sealed type tapered roller bearings
(ABU bearing) C 29

Linear ball bearings C 31

- Linear ball bearings C 35
- Flanged type C 41

Accessories C 45

- Locknuts C 47
- Lockwashers C 53
- Lock plates C 55

[Introduction]

EXSEV & Ceramic bearing series C 57

Bearings for machine tool spindles (for support of axial loading) C 59

Precision ball screw support bearings and bearing units C 61

Full complement type cylindrical roller bearings for crane sheaves C 63

Rolling mill roll neck bearings ... C 65

Deep groove ball bearings

Deep groove ball bearings are available in a variety of sizes, and are the most popular of all rolling bearings. This type of bearing supports radial load and a certain degree of axial load in both directions simultaneously.

- Shielded / sealed type
 - Simplifies sealing structure of applications.
 - Greasing is not necessary because bearings are pre-lubricated.
 - Table 1 on the next page lists major shielded and sealed bearing types and compares their performance.
- With locating snap ring
 - Bearings with a locating snap ring can be fit to the housing easily, as the locating snap ring facilitates axial positioning.
- Extra-small ball bearings and miniature ball bearings
 - The open type is widely used. Also available are the shielded/sealed type and the flanged type; the latter is easily positioned in the axial direction.



Single-row deep groove ball bearings



Open type

Bore diameter **10 – 500 mm**



Shielded/sealed type

Bore diameter **10 – 220 mm**



With snap ring groove With locating snap ring

Bore diameter **10 – 130 mm**

Extra-small ball bearings and miniature ball bearings



Bore diameter **1 – 9 mm**



Flanged type

Bore diameter **1 – 9 mm**

Double-row deep groove ball bearings



(with filling slot)

Bore diameter **10 – 75 mm**

Table 1 Comparison of shielded and sealed bearing performance

Type	Shielded		Sealed				
	Non-contact type		Non-contact type	Contact type		Extremely light contact type	
	ZZ type		2RU type	2RS type	2RK type	2RD type	
Characteristics							
	(a) ¹⁾	(b)	(c)	(d) ²⁾	(e)	(f)	(g)
Friction torque	Small		Small	Large		Large	Small
High speed performance	Good		Good	Limited because of contact			Good
Grease sealing property	Good		Better than ZZ type	Better than 2RU type for low-speed applications	Excellent		Excellent
Dirt resistance	Good		Better than ZZ type	Better than 2RU type	Excellent		Excellent
Water resistance	Economical		Better than ZZ type but inferior to 2RS, 2RK and 2RD types	Good	Excellent		Better than ZZ and 2RU types
Operating temperature ³⁾	- 30 to +110°C			- 30 to +100°C		- 30 to +110°C	

- [Notes] 1) Illustration (a) of the ZZ type shows the relatively small size bearing.
 2) Illustration (d) of the 2RS type shows the relatively small size bearing.
 3) The operating temperature range listed is for the standard type. It can be widened by using a different type of grease or sealing material. Consult with JTEKT for details.

■ Handling instructions

- The shielded/sealed type deep groove ball bearing and the deep groove ball bearing with a locating snap ring are designed for use with the inner ring rotating. Consult with JTEKT on use with the outer ring rotating.
- When the axial load is large, make the shaft shoulder and housing shoulder larger than usual. (Referring to the specification table, make the mounting dimension d_a larger and make D_a smaller.)

Boundary dimensions	The dimensions of standard series are as specified in JIS B 1512. For extra-small and miniature ball bearings, special series (ML) are specified together with those described above.																																																																									
Tolerances	As specified in JIS B 1514-1. (refer to Table 7-3 on pp. A 60 – A 63.)																																																																									
Radial internal clearance	<ul style="list-style-type: none"> Deep groove ball bearings (except extra-small ball bearings and miniature ball bearings) as specified in JIS B 1520 (refer to Table 10-2 on p. A 102.) Extra-small ball bearings and miniature ball bearings (refer to Table 10-3 on p. A 102.) Deep groove ball bearings for motors (refer to Table 10-6 on p. A 105.) 																																																																									
Recommended fits	<ul style="list-style-type: none"> Bearings of classes 0 and 6 (refer to Table 9-4 on pp. A 91, 92.) Precision extra-small ball bearings and miniature ball bearings (refer to Table 9-5 on p. A 93.) 																																																																									
Standard cages	<ul style="list-style-type: none"> Synthetic resin molded cage (supplementary code : FG, MG) Pressed cage (supplementary code : //) Copper alloy machined cage (supplementary code : FY) <p>[Remark] For certain applications, stainless steel sheet pressed cages (YS) may also be used.</p>																																																																									
	<table border="1" style="width: 100%; text-align: center;"> <thead> <tr> <th colspan="4">Application of standard cages</th> </tr> <tr> <th>Bearing series</th> <th>Molded cage</th> <th>Pressed cage</th> <th>Machined cage</th> </tr> </thead> <tbody> <tr> <td>68</td> <td>683 – 689</td> <td>-</td> <td>-</td> </tr> <tr> <td>69</td> <td>693 – 699</td> <td>-</td> <td>-</td> </tr> <tr> <td>60</td> <td>603 – 609</td> <td>-</td> <td>-</td> </tr> <tr> <td>62</td> <td>623 – 629</td> <td>-</td> <td>-</td> </tr> <tr> <td>63</td> <td>633 – 639</td> <td>-</td> <td>-</td> </tr> <tr> <td>67</td> <td>-</td> <td>6700 – 6706</td> <td>-</td> </tr> <tr> <td>68</td> <td>-</td> <td>6800 – 6838</td> <td>6840 – 68/600</td> </tr> <tr> <td>69</td> <td>-</td> <td>6900 – 6918</td> <td>6920 – 6980</td> </tr> <tr> <td>160</td> <td>-</td> <td>16001 – 16028</td> <td>16030 – 16072</td> </tr> <tr> <td>60</td> <td>6000 – 6009</td> <td>6010 – 6034</td> <td>6036 – 6084</td> </tr> <tr> <td>62</td> <td>6200 – 6208</td> <td>6209 – 6230</td> <td>6232 – 6248</td> </tr> <tr> <td>63</td> <td>6300 – 6306</td> <td>6307 – 6328</td> <td>6330 – 6340</td> </tr> <tr> <td>64</td> <td>-</td> <td>6403 – 6418</td> <td>-</td> </tr> <tr> <td>42</td> <td>-</td> <td>4200 – 4215</td> <td>-</td> </tr> <tr> <td>43</td> <td>-</td> <td>4302 – 4315</td> <td>-</td> </tr> </tbody> </table>				Application of standard cages				Bearing series	Molded cage	Pressed cage	Machined cage	68	683 – 689	-	-	69	693 – 699	-	-	60	603 – 609	-	-	62	623 – 629	-	-	63	633 – 639	-	-	67	-	6700 – 6706	-	68	-	6800 – 6838	6840 – 68/600	69	-	6900 – 6918	6920 – 6980	160	-	16001 – 16028	16030 – 16072	60	6000 – 6009	6010 – 6034	6036 – 6084	62	6200 – 6208	6209 – 6230	6232 – 6248	63	6300 – 6306	6307 – 6328	6330 – 6340	64	-	6403 – 6418	-	42	-	4200 – 4215	-	43	-	4302 – 4315	-		
Application of standard cages																																																																										
Bearing series	Molded cage	Pressed cage	Machined cage																																																																							
68	683 – 689	-	-																																																																							
69	693 – 699	-	-																																																																							
60	603 – 609	-	-																																																																							
62	623 – 629	-	-																																																																							
63	633 – 639	-	-																																																																							
67	-	6700 – 6706	-																																																																							
68	-	6800 – 6838	6840 – 68/600																																																																							
69	-	6900 – 6918	6920 – 6980																																																																							
160	-	16001 – 16028	16030 – 16072																																																																							
60	6000 – 6009	6010 – 6034	6036 – 6084																																																																							
62	6200 – 6208	6209 – 6230	6232 – 6248																																																																							
63	6300 – 6306	6307 – 6328	6330 – 6340																																																																							
64	-	6403 – 6418	-																																																																							
42	-	4200 – 4215	-																																																																							
43	-	4302 – 4315	-																																																																							
Allowable misalignment	0.002 3 – 0.003 4 rad (8' – 12')																																																																									
Equivalent radial load (Single/double-row)	<p>Dynamic equivalent radial load</p> $P_r = X F_r + Y F_a$ <p>(refer to the table on the right for values X and Y.)</p> <p>Static equivalent radial load</p> $P_{0r} = 0.6 F_r + 0.5 F_a$ <p>(when the value of $P_{0r} < F_r$, $P_{0r} = F_r$)</p> <table border="1" style="width: 100%; text-align: center;"> <thead> <tr> <th rowspan="2">$i f_0 F_a$</th> <th rowspan="2">e</th> <th colspan="2">$\frac{F_a}{F_r} \leq e$</th> <th colspan="2">$\frac{F_a}{F_r} > e$</th> </tr> <tr> <th>X</th> <th>Y</th> <th>X</th> <th>Y</th> </tr> </thead> <tbody> <tr> <td>C_{0r}</td> <td></td> <td></td> <td></td> <td></td> <td></td> </tr> <tr> <td>0.172</td> <td>0.19</td> <td></td> <td></td> <td></td> <td>2.30</td> </tr> <tr> <td>0.345</td> <td>0.22</td> <td></td> <td></td> <td></td> <td>1.99</td> </tr> <tr> <td>0.689</td> <td>0.26</td> <td></td> <td></td> <td></td> <td>1.71</td> </tr> <tr> <td>1.03</td> <td>0.28</td> <td>1</td> <td>0</td> <td>0.56</td> <td>1.55</td> </tr> <tr> <td>1.38</td> <td>0.30</td> <td></td> <td></td> <td></td> <td>1.45</td> </tr> <tr> <td>2.07</td> <td>0.34</td> <td></td> <td></td> <td></td> <td>1.31</td> </tr> <tr> <td>3.45</td> <td>0.38</td> <td></td> <td></td> <td></td> <td>1.15</td> </tr> <tr> <td>5.17</td> <td>0.42</td> <td></td> <td></td> <td></td> <td>1.04</td> </tr> <tr> <td>6.89</td> <td>0.44</td> <td></td> <td></td> <td></td> <td>1.00</td> </tr> </tbody> </table> <p>Factor f_0 is shown in the bearing dimension table.</p>				$i f_0 F_a$	e	$\frac{F_a}{F_r} \leq e$		$\frac{F_a}{F_r} > e$		X	Y	X	Y	C_{0r}						0.172	0.19				2.30	0.345	0.22				1.99	0.689	0.26				1.71	1.03	0.28	1	0	0.56	1.55	1.38	0.30				1.45	2.07	0.34				1.31	3.45	0.38				1.15	5.17	0.42				1.04	6.89	0.44				1.00
$i f_0 F_a$	e	$\frac{F_a}{F_r} \leq e$		$\frac{F_a}{F_r} > e$																																																																						
		X	Y	X	Y																																																																					
C_{0r}																																																																										
0.172	0.19				2.30																																																																					
0.345	0.22				1.99																																																																					
0.689	0.26				1.71																																																																					
1.03	0.28	1	0	0.56	1.55																																																																					
1.38	0.30				1.45																																																																					
2.07	0.34				1.31																																																																					
3.45	0.38				1.15																																																																					
5.17	0.42				1.04																																																																					
6.89	0.44				1.00																																																																					

Single-row deep groove ball bearings
open type

d 10 ~ (17) mm

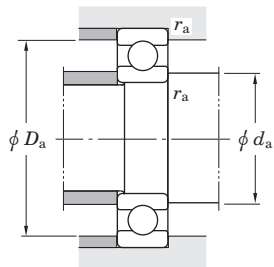
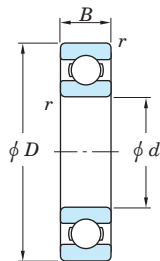

d (17) ~ 28 mm

Boundary dimensions (mm)	Basic load ratings (kN)			Factor	Limiting speeds (min ⁻¹)		Mounting dimensions (mm)	(Refer.) Mass (kg)						
	d	D	B		C _r	C _{0r}			C _u	f ₀	Grease lub.	Oil lub.	Bearing No.	d _a min.
10	15	3	0.1	1.05	0.430	0.020	15.7	39 000	47 000	6700	10.8	14.2	0.1	0.002
	19	5	0.3	2.15	0.840	0.030	14.8	37 000	43 000	6800	12	17	0.3	0.005
	22	6	0.3	3.35	1.25	0.070	14.0	34 000	41 000	6900	12	20	0.3	0.010
	26	8	0.3	5.70	1.95	0.100	12.3	31 000	36 000	6000	12	24	0.3	0.019
	30	9	0.6	6.40	2.40	0.120	13.2	24 000	29 000	6200	14	26	0.6	0.032
	35	11	0.6	10.1	3.45	0.270	11.2	22 000	27 000	6300	14	31	0.6	0.053
12	18	4	0.2	1.15	0.530	0.023	16.2	34 000	41 000	6701	13.6	16.4	0.2	0.003
	21	5	0.3	2.40	1.05	0.040	15.3	33 000	39 000	6801	14	19	0.3	0.006
	24	6	0.3	3.60	1.45	0.080	14.5	31 000	36 000	6901	14	22	0.3	0.011
	28	7	0.3	6.40	2.40	0.120	13.2	27 000	32 000	16001	14	26	0.3	0.024
	28	8	0.3	6.40	2.40	0.120	13.2	27 000	32 000	6001	14	26	0.3	0.022
	32	10	0.6	8.50	3.05	0.240	12.3	22 000	27 000	6201	16	28	0.6	0.037
	37	12	1	12.1	4.20	0.420	11.1	20 000	25 000	6301	17	32	1	0.060
	15	21	4	0.2	1.15	0.580	0.024	16.7	29 000	35 000	6702	16.6	19.4	0.2
24		5	0.3	2.60	1.25	0.050	15.8	28 000	33 000	6802	17	22	0.3	0.007
28		7	0.3	5.40	2.25	0.120	14.3	26 000	30 000	6902	17	26	0.3	0.017
32		8	0.3	7.00	2.85	0.150	13.9	23 000	28 000	16002	17	30	0.3	0.025
32		9	0.3	7.00	2.85	0.150	13.9	23 000	27 000	6002	17	30	0.3	0.030
35		11	0.6	9.55	3.75	0.290	13.2	20 000	24 000	6202	19	31	0.6	0.045
42		13	1	14.3	5.45	0.460	12.3	17 000	20 000	6302	20	37	1	0.082
17		23	4	0.2	1.25	0.660	0.027	16.9	27 000	32 000	6703	18.6	21.4	0.2
	26	5	0.3	3.30	1.55	0.060	15.7	26 000	30 000	6803	19	24	0.3	0.008
	30	7	0.3	5.75	2.55	0.130	14.7	23 000	28 000	6903	19	28	0.3	0.018
	35	8	0.3	7.50	3.25	0.170	14.4	21 000	25 000	16003	19	33	0.3	0.032
	35	10	0.3	7.50	3.25	0.170	14.4	21 000	25 000	6003	19	33	0.3	0.039
	40	12	0.6	12.0	4.80	0.370	13.2	17 000	21 000	6203	21	36	0.6	0.065
	47	14	1	17.0	6.65	0.550	12.4	15 000	18 000	6303	22	42	1	0.115
	47	14	1	19.6	7.60	0.680	12.0	15 000	18 000	6303R	22	42	1	0.121

Boundary dimensions (mm)	Basic load ratings (kN)			Factor	Limiting speeds (min ⁻¹)		Mounting dimensions (mm)	(Refer.) Mass (kg)						
	d	D	B		C _r	C _{0r}			C _u	f ₀	Grease lub.	Oil lub.	Bearing No.	d _a min.
17	62	17	1.1	25.9	9.85	0.920	11.6	13 000	15 000	6403	23.5	55.5	1	0.270
	20	27	4	0.2	1.30	0.730	0.030	16.1	23 000	27 000	6704	21.6	25.4	0.2
32		7	0.3	5.00	2.45	0.100	15.5	21 000	25 000	6804	22	30	0.3	0.018
37		9	0.3	7.95	3.70	0.190	14.7	19 000	23 000	6904	22	35	0.3	0.036
42		8	0.3	9.90	4.50	0.290	14.4	17 000	21 000	16004	22	40	0.3	0.050
42		12	0.6	11.7	5.05	0.350	13.9	17 000	21 000	6004	24	38	0.6	0.069
42		12	0.6	14.4	5.85	0.460	13.0	18 000	21 000	6004R	24	38	0.6	0.073
47		14	1	16.0	6.65	0.510	13.2	15 000	17 000	6204	25	42	1	0.106
47		14	1	19.6	7.60	0.680	12.0	15 000	18 000	6204R	25	42	1	0.114
52		15	1.1	19.9	7.85	0.660	12.3	14 000	17 000	6304	26.5	45.5	1	0.144
52		15	1.1	22.6	8.95	0.790	12.0	14 000	16 000	6304R	26.5	45.5	1	0.151
22	72	19	1.1	38.7	15.2	1.50	11.1	11 000	13 000	6404	26.5	65.5	1	0.400
	44	12	0.6	11.7	5.15	0.350	14.1	17 000	20 000	60/22	26	40	0.6	0.073
	50	14	1	16.0	6.65	0.510	13.2	15 000	17 000	62/22	27	45	1	0.118
25	56	16	1.1	23.1	9.40	0.770	12.6	13 000	15 000	63/22	28.5	49.5	1	0.201
	32	4	0.2	1.35	0.840	0.035	15.8	19 000	22 000	6705	26.6	30.4	0.2	0.006
	37	7	0.3	5.40	2.95	0.120	16.0	18 000	21 000	6805	27	35	0.3	0.022
	42	9	0.3	8.75	4.55	0.230	15.4	16 000	19 000	6905	27	40	0.3	0.041
	47	8	0.3	11.1	5.60	0.340	15.1	15 000	18 000	16005	27	45	0.3	0.060
	47	12	0.6	12.6	5.85	0.380	14.5	15 000	18 000	6005	29	43	0.6	0.080
	52	15	1	17.5	7.85	0.550	13.9	13 000	15 000	6205	30	47	1	0.128
	52	15	1	22.1	9.30	0.740	12.8	13 000	16 000	6205R	30	47	1	0.138
	62	17	1.1	25.7	11.3	0.860	13.2	11 000	13 000	6305	31.5	55.5	1	0.232
	62	17	1.1	32.7	13.4	1.20	11.9	11 000	14 000	6305R	31.5	55.5	1	0.255
28	80	21	1.5	45.2	19.4	1.65	12.2	9 100	11 000	6405	33	72	1.5	0.530
	52	12	0.6	15.6	7.40	0.480	14.5	14 000	16 000	60/28	32	48	0.6	0.097
	58	16	1	22.4	9.75	0.720	13.4	12 000	14 000	62/28	33	53	1	0.173
	68	18	1.1	29.4	13.1	0.990	13.3	10 000	12 000	63/28	34.5	61.5	1	0.328

[Remark] Standard cage types used for the above bearings are described earlier in this section.

Single-row deep groove ball bearings
open type

d 30 ~ (40) mm

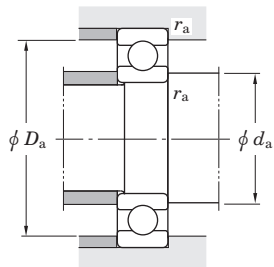
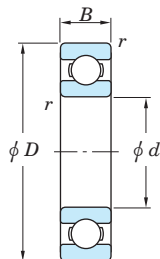

d (40) ~ (60) mm

Boundary dimensions (mm)	Basic load ratings (kN)		Fatigue load limit (kN) C_u	Factor f_0	Limiting speeds (min^{-1})		Bearing No.	Mounting dimensions (mm)			(Refer.) Mass (kg)			
	d	D			B	$r_{\text{min.}}$		C_r	C_{0r}	Grease lub.		Oil lub.	d_a min.	D_a max.
30	37	4	0.2	1.45	0.950	0.040	15.7	16 000	19 000	6706	31.6	35.4	0.2	0.008
	42	7	0.3	5.65	3.40	0.140	16.4	15 000	18 000	6806	32	40	0.3	0.026
	47	9	0.3	9.05	5.00	0.260	15.8	14 000	17 000	6906	32	45	0.3	0.045
	55	9	0.3	14.1	7.35	0.440	15.2	13 000	15 000	16006	32	53	0.3	0.085
	55	13	1	16.5	8.25	0.530	14.7	13 000	15 000	6006	35	50	1	0.116
	62	16	1	24.3	11.3	0.800	13.9	11 000	13 000	6206	35	57	1	0.199
	62	16	1	29.2	12.8	1.00	13.0	11 000	13 000	6206R	35	57	1	0.212
	72	19	1.1	33.3	15.0	1.15	13.3	9 600	12 000	6306	36.5	65.5	1	0.346
	72	19	1.1	41.7	17.7	1.55	12.0	9 800	12 000	6306R	36.5	65.5	1	0.379
	90	23	1.5	54.2	23.9	2.05	12.3	8 100	9 700	6406	38	82	1.5	0.735
32	58	13	1	18.8	9.15	0.600	14.5	12 000	14 000	60/32	37	53	1	0.127
	65	17	1	29.4	13.1	0.990	13.3	10 000	12 000	62/32	37	60	1	0.228
	75	20	1.1	37.6	16.2	1.30	12.7	9 300	11 000	63/32	38.5	68.5	1	0.437
35	47	7	0.3	5.95	3.85	0.160	16.5	13 000	16 000	6807	37	45	0.3	0.030
	55	10	0.6	13.6	7.75	0.440	15.7	12 000	14 000	6907	39	51	0.6	0.073
	62	9	0.3	15.3	8.85	0.500	15.7	11 000	13 000	16007	37	60	0.3	0.110
	62	14	1	19.9	10.3	0.640	14.9	11 000	13 000	6007	40	58	1	0.155
	72	17	1.1	32.1	15.4	1.10	13.9	9 200	11 000	6207	41.5	65.5	1	0.288
	72	17	1.1	38.7	17.5	1.40	12.9	9 300	11 000	6207R	41.5	65.5	1	0.309
	80	21	1.5	41.7	19.3	1.45	13.2	8 500	10 000	6307	43	72	1.5	0.457
	80	21	1.5	50.0	21.7	1.90	12.1	8 700	10 000	6307R	43	72	1.5	0.494
	100	25	1.5	68.8	31.0	2.65	12.2	7 200	8 600	6407	43	92	1.5	0.952
	40	52	7	0.3	6.15	4.20	0.180	16.3	12 000	14 000	6808	42	50	0.3
62		12	0.6	17.1	9.95	0.570	15.6	11 000	13 000	6908	44	58	0.6	0.112
68		9	0.3	15.8	9.65	0.530	16.0	9 800	12 000	16008	42	66	0.3	0.125
68		15	1	20.9	11.5	0.690	15.2	10 000	12 000	6008	45	63	1	0.192
80		18	1.1	36.4	17.8	1.25	14.0	8 300	10 000	6208	46.5	73.5	1	0.366
90		23	1.5	50.9	24.0	1.85	13.2	7 700	9 200	6308	48	82	1.5	0.633

[Remark] Standard cage types used for the above bearings are described earlier in this section.

Boundary dimensions (mm)	Basic load ratings (kN)		Fatigue load limit (kN) C_u	Factor f_0	Limiting speeds (min^{-1})		Bearing No.	Mounting dimensions (mm)			(Refer.) Mass (kg)				
	d	D			B	$r_{\text{min.}}$		C_r	C_{0r}	Grease lub.		Oil lub.	d_a min.	D_a max.	r_a max.
40	110	27	2	79.6	36.6	3.15	12.3	6 600	7 900	6408	49	101	2	1.23	
	45	58	7	0.3	7.75	5.40	0.230	16.3	11 000	13 000	6809	47	56	0.3	0.040
68		12	0.6	17.7	10.9	0.600	15.9	9 700	11 000	6909	49	64	0.6	0.132	
75		10	0.6	19.4	12.3	0.670	16.0	8 900	10 000	16009	49	71	0.6	0.170	
75		16	1	26.2	15.1	0.900	15.3	9 200	11 000	6009	50	70	1	0.245	
85		19	1.1	40.9	20.3	1.40	14.0	7 700	9 200	6209	51.5	78.5	1	0.407	
100		25	1.5	61.1	29.5	2.25	13.3	6 800	8 100	6309	53	92	1.5	0.833	
120		29	2	96.5	45.1	3.90	12.2	6 000	7 200	6409	54	111	2	1.53	
50		65	7	0.3	8.20	6.10	0.260	16.1	9 600	11 000	6810	52	63	0.3	0.052
	72	12	0.6	18.2	11.7	0.640	16.1	9 000	11 000	6910	54	68	0.6	0.133	
	80	10	0.6	20.0	13.3	0.710	16.2	8 200	9 700	16010	54	76	0.6	0.180	
	80	16	1	27.3	16.6	0.960	15.6	8 400	9 900	6010	55	75	1	0.261	
	90	20	1.1	43.9	23.3	1.55	14.4	7 100	8 500	6210	56.5	83.5	1	0.463	
	90	20	1.1	50.5	25.5	1.80	13.9	7 100	8 600	6210R	56.5	83.5	1	0.487	
	110	27	2	77.5	38.3	2.90	13.2	6 100	7 300	6310	59	101	2	1.07	
	130	31	2.1	104	49.5	4.10	12.5	5 500	6 600	6410	61	119	2	1.88	
	55	72	9	0.3	11.0	8.10	0.420	16.2	8 700	10 000	6811	57	70	0.3	0.083
		80	13	1	20.8	14.1	0.760	16.2	8 100	9 600	6911	60	75	1	0.185
90		11	0.6	24.2	16.3	0.880	16.2	7 400	8 800	16011	59	86	0.6	0.260	
90		18	1.1	35.3	21.2	1.25	15.3	7 600	8 900	6011	61.5	83.5	1	0.385	
100		21	1.5	54.2	29.4	1.95	14.4	6 300	7 600	6211	63	92	1.5	0.607	
120		29	2	89.5	45.0	3.45	13.2	5 600	6 700	6311	64	111	2	1.37	
140		33	2.1	126	62.3	5.35	12.2	5 000	6 000	6411	66	129	2	2.29	
60		78	10	0.3	14.3	10.6	0.550	16.3	8 000	9 400	6812	62	76	0.3	0.104
	85	13	1	25.2	17.3	0.940	16.2	7 500	8 900	6912	65	80	1	0.192	
	95	11	0.6	24.8	17.6	0.930	16.4	6 900	8 100	16012	64	91	0.6	0.280	
	95	18	1.1	36.8	23.2	1.35	15.6	7 100	8 400	6012	66.5	88.5	1	0.415	

Single-row deep groove ball bearings
open type

d (60) ~ (80) mm

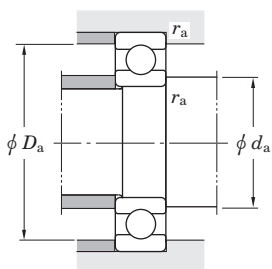
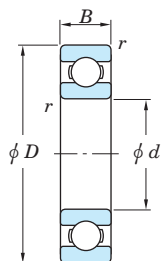

d (80) ~ (100) mm

Boundary dimensions (mm)	Basic load ratings (kN)		Fatigue load limit (kN) <i>C</i> _u	Factor <i>f</i> ₀	Limiting speeds (min ⁻¹)		Bearing No.	Mounting dimensions (mm)			(Refer.) Mass (kg)			
	<i>d</i>	<i>D</i>			<i>B</i>	<i>r</i> _{min.}		<i>C</i> _r	<i>C</i> _{0r}	Grease lub.		Oil lub.	<i>d</i> _a min.	<i>D</i> _a max.
60	110	22	1.5	65.6	36.2	2.40	14.4	5 700	6 900	6212	68	102	1.5	0.783
	130	31	2.1	102	52.2	3.95	13.2	5 200	6 200	6312	71	119	2	1.70
	150	35	2.1	137	70.8	5.75	12.4	4 600	5 500	6412	71	139	2	2.77
65	85	10	0.6	14.9	11.5	0.590	16.2	7 300	8 600	6813	69	81	0.6	0.126
	90	13	1	21.7	16.1	0.830	16.6	7 100	8 400	6913	70	85	1	0.211
	100	11	0.6	21.4	16.0	0.830	16.5	6 600	7 800	16013	69	96	0.6	0.300
	100	18	1.1	38.1	25.2	1.40	15.8	6 600	7 800	6013	71.5	93.5	1	0.435
	120	23	1.5	71.5	40.1	2.65	14.4	5 400	6 400	6213	73	112	1.5	0.990
	140	33	2.1	116	59.9	4.50	13.2	4 800	5 800	6313	76	129	2	2.08
	160	37	2.1	148	79.2	6.20	12.4	4 300	5 200	6413	76	149	2	3.30
70	90	10	0.6	15.1	11.9	0.620	16.1	6 800	8 100	6814	74	86	0.6	0.134
	100	16	1	29.7	21.2	1.10	16.3	6 400	7 600	6914	75	95	1	0.342
	110	13	0.6	37.6	25.6	1.40	16.0	6 100	7 200	16014	74	106	0.6	0.433
	110	20	1.1	47.6	30.9	1.80	15.6	6 100	7 200	6014	76.5	103.5	1	0.602
	125	24	1.5	77.8	44.1	2.90	14.5	5 100	6 100	6214	78	117	1.5	1.07
	150	35	2.1	130	68.2	4.95	13.2	4 500	5 400	6314	81	139	2	2.52
	180	42	3	181	104	10.2	12.2	3 900	4 600	6414	83	167	2.5	4.83
75	95	10	0.6	15.7	12.9	0.660	16.0	6 400	7 600	6815	79	91	0.6	0.142
	105	16	1	30.5	22.6	1.20	16.5	6 100	7 200	6915	80	100	1	0.363
	115	13	0.6	34.4	25.3	1.35	16.4	5 700	6 700	16015	79	111	0.6	0.457
	115	20	1.1	49.4	33.5	1.90	15.8	5 700	6 800	6015	81.5	108.5	1	0.638
	130	25	1.5	84.3	48.3	3.10	14.5	4 800	5 800	6215	83	122	1.5	1.18
	160	37	2.1	142	77.2	5.40	13.2	4 200	5 000	6315	86	149	2	3.02
	190	45	3	192	115	10.9	12.3	3 600	4 400	6415	88	177	2.5	5.87
80	100	10	0.6	15.9	13.3	0.690	16.0	6 100	7 200	6816	84	96	0.6	0.150
	110	16	1	31.2	24.0	1.25	16.6	5 700	6 800	6916	85	105	1	0.382
	125	14	0.6	39.7	29.7	1.50	16.4	5 200	6 100	16016	84	121	0.6	0.597

[Remark] Standard cage types used for the above bearings are described earlier in this section.

Boundary dimensions (mm)	Basic load ratings (kN)		Fatigue load limit (kN) <i>C</i> _u	Factor <i>f</i> ₀	Limiting speeds (min ⁻¹)		Bearing No.	Mounting dimensions (mm)			(Refer.) Mass (kg)			
	<i>d</i>	<i>D</i>			<i>B</i>	<i>r</i> _{min.}		<i>C</i> _r	<i>C</i> _{0r}	Grease lub.		Oil lub.	<i>d</i> _a min.	<i>D</i> _a max.
80	125	22	1.1	59.5	39.8	2.25	15.6	5 300	6 300	6016	86.5	118.5	1	0.850
	140	26	2	90.9	53.0	3.25	14.6	4 500	5 400	6216	89	131	2	1.40
	170	39	2.1	154	86.7	5.85	13.3	3 900	4 700	6316	91	159	2	3.59
	200	48	3	205	125	11.5	12.3	3 400	4 100	6416	93	187	2.5	6.84
85	110	13	1	23.4	19.0	0.980	16.2	5 600	6 600	6817	90	105	1	0.266
	120	18	1.1	39.9	29.6	1.55	16.4	5 300	6 300	6917	91.5	113.5	1	0.535
	130	14	0.6	40.8	31.7	1.55	16.5	4 900	5 800	16017	89	126	0.6	0.626
	130	22	1.1	61.8	43.1	2.35	15.8	5 000	5 900	6017	91.5	123.5	1	0.890
	150	28	2	105	61.9	3.70	14.5	4 200	5 000	6217	94	141	2	1.79
	180	41	3	166	96.8	6.35	13.3	3 700	4 400	6317	98	167	2.5	4.23
	210	52	4	217	136	12.2	12.3	3 300	3 900	6417	101	194	3	8.07
90	115	13	1	23.8	19.7	1.00	16.1	5 300	6 300	6818	95	110	1	0.279
	125	18	1.1	41.0	31.6	1.60	16.5	5 100	6 000	6918	96.5	118.5	1	0.565
	140	16	1	49.9	37.0	1.85	16.3	4 700	5 600	16018	95	135	1	0.848
	140	24	1.5	72.8	49.7	2.65	15.6	4 700	5 600	6018	98	132	1.5	1.16
	160	30	2	120	71.5	4.20	14.5	3 900	4 700	6218	99	151	2	2.15
	190	43	3	178	107	8.80	13.3	3 500	4 200	6318	103	177	2.5	4.91
	225	54	4	230	149	12.7	12.5	3 100	3 700	6418	106	209	3	9.78
95	130	18	1.1	42.1	33.5	1.65	16.6	4 800	5 700	6919	101.5	123.5	1	0.705
	145	16	1	51.5	39.6	1.90	16.4	4 500	5 300	16019	100	140	1	0.885
	145	24	1.5	75.5	53.9	2.75	15.8	4 400	5 200	6019	103	137	1.5	1.21
	170	32	2.1	136	81.9	4.65	14.4	3 700	4 400	6219	106	159	2	2.62
	200	45	3	191	119	9.45	13.3	3 300	4 000	6319	108	187	2.5	5.67
100	125	13	1	24.5	21.2	1.05	16.0	4 800	5 700	6820	105	120	1	0.309
	140	20	1.1	56.2	41.9	2.05	16.2	4 500	5 300	6920	106.5	133.5	1	0.960
	150	16	1	53.0	42.1	1.95	16.5	4 300	5 100	16020	105	145	1	0.910
	150	24	1.5	75.2	54.2	2.70	15.9	4 300	5 100	6020	108	142	1.5	1.25

Single-row deep groove ball bearings
open type

d (100) ~ (140) mm

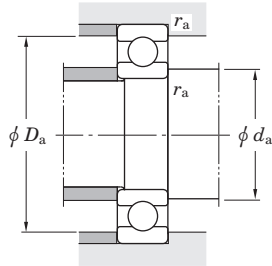
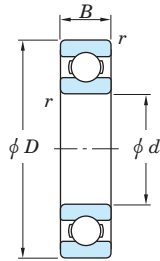

d (140) ~ (190) mm

Boundary dimensions (mm)	Basic load ratings (kN)		Fatigue load limit (kN) C_u	Factor f_0	Limiting speeds (min^{-1})		Bearing No.	Mounting dimensions (mm)			(Refer.) Mass (kg)			
					Grease lub.	Oil lub.		d_a min.	D_a max.	r_a max.				
d	D	B	$r_{\text{min.}}$	C_r	C_{0r}									
100	180	34	2.1	153	93.1	5.15	14.4	3 500	4 200	6220	111	169	2	3.14
	215	47	3	216	141	10.9	13.2	3 000	3 600	6320	113	202	2.5	7.00
105	145	20	1.1	58.1	44.8	2.10	16.4	4 300	5 100	6921	111.5	138.5	1	1.00
	160	18	1	52.3	42.2	1.90	16.5	4 100	4 800	16021	110	155	1	1.20
	160	26	2	90.4	65.8	3.20	15.8	4 000	4 700	6021	114	151	2	1.59
	190	36	2.1	166	105	5.70	14.4	3 300	3 900	6221	116	179	2	3.70
	225	49	3	230	153	11.7	13.2	2 900	3 500	6321	118	212	2.5	8.05
110	140	16	1	35.1	30.7	1.40	16.1	4 300	5 100	6822	115	135	1	0.606
	150	20	1.1	59.9	47.8	2.20	16.4	4 100	4 900	6922	116.5	143.5	1	1.04
	170	19	1	71.8	56.7	2.55	16.3	3 800	4 500	16022	115	165	1	1.46
	170	28	2	103	73.0	3.55	15.6	3 800	4 500	6022	119	161	2	1.96
	200	38	2.1	180	117	6.20	14.4	3 100	3 700	6222	121	189	2	4.36
240	50	3	257	180	13.3	13.2	2 700	3 200	6322	123	227	2.5	9.54	
120	150	16	1	36.2	33.0	1.45	16.0	4 000	4 700	6824	125	145	1	0.655
	165	22	1.1	71.6	56.9	2.50	16.4	3 800	4 400	6924	126.5	158.5	1	1.41
	180	19	1	79.0	63.3	2.75	16.4	3 600	4 200	16024	125	175	1	1.80
	180	28	2	106	79.3	3.60	15.9	3 600	4 200	6024	129	171	2	2.07
	215	40	2.1	194	131	6.65	14.4	2 900	3 400	6224	131	204	2	5.15
	260	55	3	258	185	12.6	13.5	2 500	3 000	6324	133	247	2.5	12.5
130	165	18	1.1	46.1	41.2	1.75	16.1	3 600	4 300	6826	136.5	158.5	1	0.939
	180	24	1.5	86.9	67.4	3.00	16.3	3 400	4 100	6926	138	172	1.5	1.86
	200	22	1.1	89.1	74.8	3.05	11.2	3 000	3 600	16026	136.5	193.5	1	2.69
	200	33	2	133	101	4.45	15.8	3 200	3 800	6026	139	191	2	3.16
	230	40	3	209	146	9.15	14.5	2 700	3 200	6226	143	217	2.5	5.82
	280	58	4	287	214	14.1	13.6	2 300	2 700	6326	146	264	3	15.1
140	175	18	1.1	47.8	44.4	1.85	16.0	3 400	4 000	6828	146.5	168.5	1	1.00
	190	24	1.5	89.1	74.8	3.05	16.5	3 200	3 800	6928	148	182	1.5	1.98
	210	22	1.1	82.2	71.1	2.80	16.5	2 900	3 400	16028	146.5	203.5	1	2.86

[Remark] Standard cage types used for the above bearings are described earlier in this section.

Boundary dimensions (mm)	Basic load ratings (kN)		Fatigue load limit (kN) C_u	Factor f_0	Limiting speeds (min^{-1})		Bearing No.	Mounting dimensions (mm)			(Refer.) Mass (kg)			
					Grease lub.	Oil lub.		d_a min.	D_a max.	r_a max.				
d	D	B	$r_{\text{min.}}$	C_r	C_{0r}									
140	210	33	2	137	109	4.55	15.9	3 000	3 600	6028	149	201	2	3.55
	250	42	3	208	150	8.65	14.8	2 400	2 900	6228	153	237	2.5	7.45
	300	62	4	316	246	15.6	13.6	2 100	2 500	6328	156	284	3	19.4
150	190	20	1.1	59.7	54.9	2.20	16.1	3 100	3 700	6830	156.5	183.5	1	1.40
	210	28	2	117	94.3	3.75	16.2	2 900	3 400	6930	159	201	2	3.05
	225	24	1.1	114	99.3	3.70	16.6	2 700	3 100	16030	156.5	218.5	1	3.58
	225	35	2.1	157	126	5.10	16.0	2 800	3 300	6030	161	214	2	4.22
	270	45	3	220	168	9.05	15.1	2 200	2 700	6230	163	257	2.5	9.41
320	65	4	343	284	16.6	13.9	1 900	2 300	6330	166	304	3	26.2	
160	200	20	1.1	60.5	56.9	2.20	16.1	2 900	3 400	6832	166.5	193.5	1	1.45
	220	28	2	120	101	3.85	16.4	2 700	3 200	6932	169	211	2	3.20
	240	25	1.5	124	108	3.95	16.5	2 600	3 100	16032	168	232	1.5	4.25
	240	38	2.1	171	135	5.30	15.9	2 600	3 000	6032	171	229	2	5.22
	290	48	3	231	186	9.45	15.4	2 100	2 500	6232	173	277	2.5	14.3
	340	68	4	347	286	16.4	13.9	1 800	2 200	6332	176	324	3	29.0
170	215	22	1.1	74.8	70.5	2.60	16.1	2 700	3 200	6834	176.5	208.5	1	1.90
	230	28	2	124	108	3.95	16.5	2 600	3 100	6934	179	221	2	3.35
	260	28	1.5	142	127	4.45	16.5	2 300	2 700	16034	178	252	1.5	5.75
	260	42	2.1	201	161	6.20	15.8	2 400	2 800	6034	181	249	2	6.80
	310	52	4	265	223	11.1	15.3	1 900	2 300	6234	186	294	3	17.5
	360	72	4	408	355	20.5	13.6	1 700	2 000	6334	186	344	3	38.6
180	225	22	1.1	75.8	73.1	2.65	16.1	2 600	3 000	6836	186.5	218.5	1	2.00
	250	33	2	153	129	4.70	16.3	2 400	2 800	6936	189	241	2	4.90
	280	31	2	169	148	5.15	16.4	2 100	2 500	16036	189	271	2	7.55
	280	46	2.1	227	194	7.15	15.8	2 200	2 600	6036	191	269	2	10.3
	320	52	4	284	241	12.0	15.1	1 800	2 200	6236	196	304	3	18.3
	380	75	4	443	407	22.1	13.9	1 600	1 900	6336	196	364	3	44.7
190	240	24	1.5	91.4	88.1	3.10	16.1	2 400	2 800	6838	198	232	1.5	2.60

Single-row deep groove ball bearings
open type

d (190) ~ (260) mm

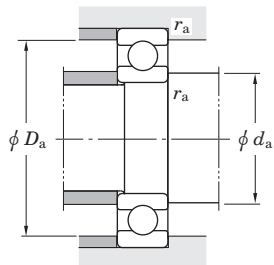
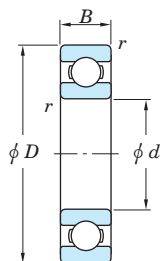

d (260) ~ (360) mm

Boundary dimensions (mm)	Basic load ratings (kN)		Fatigue load limit (kN) C _u	Factor f ₀	Limiting speeds (min ⁻¹)		Bearing No.	Mounting dimensions (mm)			(Refer.) Mass (kg)			
	d	D			B	r _{min.}		C _r	C _{0r}	Grease lub.		Oil lub.	d _a min.	D _a max.
190	260	33	2	158	138	4.85	16.4	2 300	2 700	6938	199	251	2	5.20
	290	31	2	173	158	5.20	16.6	2 000	2 400	16038	199	281	2	7.85
	290	46	2.1	235	201	7.35	15.8	2 100	2 500	6038	201	279	2	10.8
	340	55	4	319	281	13.7	15.0	1 700	2 000	6238	206	324	3	23.0
	400	78	5	443	415	21.3	14.1	1 500	1 800	6338	210	380	4	51.5
200	250	24	1.5	97.6	93.6	3.20	16.1	2 300	2 700	6840	208	242	1.5	2.70
	280	38	2.1	196	168	5.80	16.2	2 100	2 500	6940	211	269	2	7.30
	310	34	2	201	180	5.95	16.4	1 900	2 300	16040	209	301	2	10.1
	310	51	2.1	272	243	11.3	15.6	1 900	2 300	6040	211	299	2	14.0
	360	58	4	336	311	14.4	15.2	1 600	1 900	6240	216	344	3	28.2
	420	80	5	513	506	25.5	14.0	1 300	1 600	6340	220	400	4	58.0
220	270	24	1.5	101	101	3.35	16.0	2 000	2 400	6844	228	262	1.5	3.00
	300	38	2.1	201	180	5.85	16.4	1 900	2 200	6944	231	289	2	7.90
	340	37	2.1	225	217	6.65	16.5	1 700	2 000	16044	231	329	2	13.2
	340	56	3	294	271	12.0	15.6	1 700	2 000	6044	233	327	2.5	18.3
	400	65	4	389	376	16.8	15.1	1 400	1 700	6244	236	384	3	37.0
	460	88	5	542	539	26.7	13.8	1 200	1 500	6344	240	440	4	71.6
240	300	28	2	135	135	4.25	16.1	1 800	2 100	6848	249	291	2	4.50
	320	38	2.1	205	192	5.95	16.5	1 700	2 000	6948	251	309	2	8.50
	360	37	2.1	230	228	6.75	16.5	1 600	1 800	16048	251	349	2	14.1
	360	56	3	305	296	12.3	15.9	1 600	1 900	6048	253	347	2.5	19.7
	440	72	4	424	431	18.2	15.2	1 200	1 500	6248	256	424	3	51.0
	500	95	5	587	624	28.2	14.2	1 100	1 300	6348	260	480	4	93.3
260	320	28	2	141	146	4.40	16.0	1 700	2 000	6852	269	311	2	4.80
	360	46	2.1	266	263	10.2	16.3	1 500	1 800	6952	271	349	2	14.4
	400	44	3	295	310	11.5	16.4	1 400	1 600	16052	273	387	2.5	21.6
	400	65	4	364	377	15.0	15.8	1 400	1 700	6052	276	384	3	29.3
	480	80	5	502	541	22.2	15.1	1 100	1 300	6252	280	460	4	68.2

[Remark] Standard cage types used for the above bearings are described earlier in this section.

Boundary dimensions (mm)	Basic load ratings (kN)		Fatigue load limit (kN) C _u	Factor f ₀	Limiting speeds (min ⁻¹)		Bearing No.	Mounting dimensions (mm)			(Refer.) Mass (kg)			
	d	D			B	r _{min.}		C _r	C _{0r}	Grease lub.		Oil lub.	d _a min.	D _a max.
260	540	102	6	663	741	32.4	14.2	990	1 200	6352	284	516	5	116
	280	350	33	2	179	183	5.35	16.1	1 500	1 800	6856	289	341	2
380		46	2.1	273	283	10.5	16.5	1 400	1 700	6956	291	369	2	15.1
420		44	3	302	331	11.7	14.7	1 300	1 500	16056	293	407	2.5	22.9
420		65	4	377	408	15.5	16.0	1 300	1 500	6056	296	404	3	31.0
500		80	5	529	599	23.2	15.3	1 000	1 200	6256	300	480	4	71.8
580		108	6	711	845	33.9	14.5	880	1 100	6356	304	556	5	145
300	380	38	2.1	224	230	6.45	16.2	1 400	1 600	6860	311	369	2	10.5
	420	56	3	345	377	13.7	16.2	1 300	1 500	6960	313	407	2.5	24.1
	460	50	4	355	405	14.0	16.4	1 100	1 400	16060	316	447	3	32.2
	460	74	4	444	482	18.4	15.6	1 200	1 400	6060	316	444	3	44.0
	540	85	5	551	663	23.5	15.6	880	1 100	6260	320	520	4	89.5
	620	109	7.5	741	886	35.0	14.4	810	970	6360	332	588	6	169
320	400	38	2.1	227	239	6.50	16.1	1 300	1 500	6864	331	389	2	11.0
	440	56	3	356	404	14.1	16.4	1 200	1 400	6964	333	427	2.5	25.5
	480	50	4	364	432	14.3	16.5	1 100	1 300	16064	336	467	3	33.9
	480	74	4	441	487	17.8	15.7	1 100	1 300	6064	336	464	3	46.0
	580	92	5	612	745	26.7	15.4	840	1 000	6264	340	560	4	113
	670	112	7.5	793	1 010	36.9	14.8	720	870	6364	352	638	6	207
340	420	38	2.1	231	249	6.60	16.1	1 200	1 400	6868	351	409	2	11.5
	460	56	3	352	407	13.7	16.5	1 100	1 300	6968	353	447	2.5	26.8
	520	57	4	419	512	16.8	16.4	980	1 200	16068	356	507	3	46.8
	520	82	5	552	661	23.7	15.6	980	1 200	6068	360	500	4	61.8
	620	92	6	639	817	27.7	15.6	760	910	6268	364	596	5	131
	710	118	7.5	880	1 160	41.7	14.7	660	790	6368	372	678	6	238
360	440	38	2.1	240	268	6.95	16.0	1 100	1 300	6872	371	429	2	12.0
	480	56	3	362	432	14.0	16.5	1 000	1 200	6972	373	467	2.5	28.2
	540	57	4	431	546	17.2	16.5	900	1 100	16072	376	527	3	49.0

Single-row deep groove ball bearings
open type

d (360) ~ (500) mm

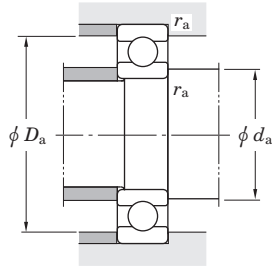
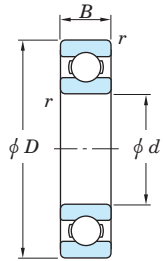

d (500) mm

Boundary dimensions (mm)	Basic load ratings (kN)		Fatigue load limit (kN) C_u	Factor f_0	Limiting speeds (min^{-1})		Bearing No.	Mounting dimensions (mm)			(Refer.) Mass (kg)			
	d	D			B	r_{min}		C_r	C_{0r}	Grease lub.		Oil lub.	d_a min.	D_a max.
360	540	82	5	548	668	23.0	15.7	920	1 100	6072	380	520	4	64.7
	650	95	6	696	904	30.4	15.4	700	840		6272	384	626	5
380	480	46	2.1	305	359	8.95	16.2	980	1 200	6876	391	469	2	20.0
	520	65	4	440	552	17.6	16.4	920	1 100	6976	396	504	3	40.8
	560	82	5	572	725	24.1	15.9	860	1 000	6076	400	540	4	67.6
	680	95	6	730	990	31.9	15.6	650	780	6276	404	656	5	162
400	500	46	2.1	311	374	9.10	16.1	920	1 100	6880	411	489	2	20.5
	540	65	4	453	588	18.1	16.5	860	1 000	6980	416	524	3	42.7
	600	63	5	447	587	17.5	16.5	780	920	16080	420	580	4	65.0
	600	90	5	635	824	27.0	15.7	780	920	6080	420	580	4	87.7
	720	103	6	785	1 080	34.2	15.5	590	710	6280	424	696	5	197
420	520	46	2.1	316	389	9.25	16.1	860	1 000	6884	431	509	2	21.5
	560	65	4	449	588	17.7	16.5	810	950	6984	436	544	3	43.5
	620	63	5	459	617	18.0	16.4	740	870	16084	440	600	4	69.9
	620	90	5	663	894	28.3	15.8	740	870	6084	440	600	4	91.2
440	540	46	2.1	321	404	9.40	16.0	810	950	6888	451	529	2	22.5
	600	74	4	529	676	21.4	16.4	740	870	6988	456	584	3	61.3
	650	67	5	508	710	20.2	16.5	680	810	16088	460	630	4	81.7
460	580	56	3	393	517	11.7	16.2	740	870	6892	473	567	2.5	35.0
	620	74	4	509	711	20.3	16.5	690	820	6992	476	604	3	61.7
	680	71	5	539	767	21.4	16.5	630	750	16092	480	660	4	91.2
480	600	56	3	401	539	12.0	16.1	690	820	6896	493	587	2.5	36.5
	650	78	5	540	768	21.5	16.5	640	760	6996	500	630	4	72.5
	700	71	5	554	807	22.1	16.5	600	710	16096	500	680	4	98.5
500	620	56	3	409	561	12.2	16.1	650	770	68/500	513	607	2.5	37.5
	670	78	5	556	807	22.2	16.5	610	720	69/500	520	650	4	75.2

[Remark] Standard cage types used for the above bearings are described earlier in this section.

Boundary dimensions (mm)	Basic load ratings (kN)		Fatigue load limit (kN) C_u	Factor f_0	Limiting speeds (min^{-1})		Bearing No.	Mounting dimensions (mm)			(Refer.) Mass (kg)			
	d	D			B	r_{min}		C_r	C_{0r}	Grease lub.		Oil lub.	d_a min.	D_a max.
500	720	71	5	568	846	22.7	16.4	560	660	160/500 60/500	520	700	4	102
	720	100	6	749	1 100	31.3	16.0	570	670		524	696	5	128

Single-row deep groove ball bearings
shielded type
sealed type
d 10 ~ (20) mm



Boundary dimensions (mm)				Basic load ratings (kN)		Fatigue load limit (kN) <i>C_u</i>	Factor <i>f₀</i>	Limiting speeds (min ⁻¹)				Bearing No.	Mounting dimensions (mm)				(Refer.) Mass Open type (kg)			
<i>d</i>	<i>D</i>	<i>B</i>	<i>r</i> _{min.}	<i>C_r</i>	<i>C_{0r}</i>			Grease lub.		Oil lub.			Shielded	Non-contact sealed	Extremely light contact sealed	Contact sealed		<i>d_a</i> min.	<i>d_a</i> max.	<i>D_a</i> max.
10	19	5	0.3	2.15	0.840	0.030	14.8	37 000	—	22 000	43 000	6800 ZZ	6800 2RU	—	6800 2RS	12	12	17	0.3	0.005
	22	6	0.3	3.35	1.25	0.070	14.0	34 000	—	21 000	41 000	6900 ZZ	6900 2RU	—	6900 2RS	12	12.5	20	0.3	0.010
	26	8	0.3	5.70	1.95	0.100	12.3	31 000	28 000	19 000	36 000	6000 ZZ	6000 2RU	6000 2RD	6000 2RS	12	13	24	0.3	0.019
	30	9	0.6	6.40	2.40	0.120	13.2	24 000	22 000	16 000	29 000	6200 ZZ	6200 2RU	6200 2RD	6200 2RS	14	15	26	0.6	0.032
	35	11	0.6	10.1	3.45	0.270	11.2	22 000	20 000	16 000	27 000	6300 ZZ	6300 2RU	6300 2RD	6300 2RS	14	16	31	0.6	0.053
12	18	4	0.2	1.15	0.530	0.023	16.2	34 000	—	20 000	41 000	6701 ZZX	6701 2RU	—	6701 2RS	13.6	—	16.4	0.2	0.003
	21	5	0.3	2.40	1.05	0.040	15.3	33 000	30 000	20 000	39 000	6801 ZZ	6801 2RU	6801 2RD	6801 2RS	14	14	19	0.3	0.006
	24	6	0.3	3.60	1.45	0.080	14.5	31 000	28 000	18 000	36 000	6901 ZZ	6901 2RU	6901 2RD	6901 2RS	14	14	22	0.3	0.011
	28	8	0.3	6.40	2.40	0.120	13.2	27 000	24 000	17 000	32 000	6001 ZZ	6001 2RU	6001 2RD	6001 2RS	14	15	26	0.3	0.022
	32	10	0.6	8.50	3.05	0.240	12.3	22 000	20 000	15 000	27 000	6201 ZZ	6201 2RU	6201 2RD	6201 2RS	16	16.5	28	0.6	0.037
	37	12	1	12.1	4.20	0.420	11.1	20 000	18 000	15 000	25 000	6301 ZZ	6301 2RU	6301 2RD	6301 2RS	17	17.5	32	1	0.060
15	21	4	0.2	1.15	0.580	0.024	16.7	29 000	—	16 000	35 000	6702 ZZX	6702 2RU	—	6702 2RS	16.6	—	19.4	0.2	0.004
	24	5	0.3	2.60	1.25	0.050	15.8	28 000	—	16 000	33 000	6802 ZZ	6802 2RU	—	6802 2RS	17	17	22	0.3	0.007
	28	7	0.3	5.40	2.25	0.120	14.3	26 000	23 000	15 000	30 000	6902 ZZ	6902 2RU	6902 2RD	6902 2RS	17	18	26	0.3	0.017
	32	9	0.3	7.00	2.85	0.150	13.9	23 000	21 000	14 000	27 000	6002 ZZ	6002 2RU	6002 2RD	6002 2RS	17	18.5	30	0.3	0.030
	35	11	0.6	9.55	3.75	0.290	13.2	20 000	18 000	13 000	24 000	6202 ZZ	6202 2RU	6202 2RD	6202 2RS	19	19.5	31	0.6	0.045
	42	13	1	14.3	5.45	0.460	12.3	17 000	15 000	12 000	20 000	6302 ZZ	6302 2RU	6302 2RD	6302 2RS	20	21.5	37	1	0.082
17	23	4	0.2	1.25	0.660	0.027	16.9	27 000	—	15 000	32 000	6703 ZZ	6703 2RU	—	6703 2RS	18.6	—	21.4	0.2	0.005
	26	5	0.3	3.30	1.55	0.060	15.7	26 000	—	14 000	30 000	6803 ZZ	6803 2RU	—	6803 2RS	19	19	24	0.3	0.008
	30	7	0.3	5.75	2.55	0.130	14.7	23 000	21 000	13 000	28 000	6903 ZZ	6903 2RU	6903 2RD	6903 2RS	19	19.5	28	0.3	0.018
	35	10	0.3	7.50	3.25	0.170	14.4	21 000	19 000	12 000	25 000	6003 ZZ	6003 2RU	6003 2RD	6003 2RS	19	21	33	0.3	0.039
	40	12	0.6	12.0	4.80	0.370	13.2	17 000	15 000	12 000	21 000	6203 ZZ	6203 2RU	6203 2RD	6203 2RS	21	22	36	0.6	0.065
	47	14	1	17.0	6.65	0.550	12.4	15 000	14 000	10 000	18 000	6303 ZZ	6303 2RU	6303 2RD	6303 2RS	22	24.3	42	1	0.115
20	27	4	0.2	1.30	0.730	0.030	16.1	23 000	—	12 000	27 000	6704 ZZ	6704 2RU	—	6704 2RS	21.6	—	25.4	0.2	0.006
	32	7	0.3	5.00	2.45	0.100	15.5	21 000	—	12 000	25 000	6804 ZZ	6804 2RU	—	6804 2RS	22	22.5	30	0.3	0.018
	37	9	0.3	7.95	3.70	0.190	14.7	19 000	17 000	11 000	23 000	6904 ZZ	6904 2RU	6904 2RD	6904 2RS	22	23.5	35	0.3	0.036
	42	12	0.6	11.7	5.05	0.350	13.9	17 000	15 000	10 000	21 000	6004 ZZ	6004 2RU	6004 2RD	6004 2RS	24	25	38	0.6	0.069
	47	14	1	16.0	6.65	0.510	13.2	15 000	14 000	9 700	17 000	6204 ZZ	6204 2RU	6204 2RD	6204 2RS	25	26.5	42	1	0.106

[Remark] Standard cage types used for the above bearings are described earlier in this section.

Single-row deep groove ball bearings
shielded type
sealed type

d (20) ~ 35 mm



Boundary dimensions (mm)				Basic load ratings (kN)		Fatigue load limit (kN) C_u	Factor f_0	Limiting speeds (min^{-1})			Oil lub. (Z)	Bearing No.				Mounting dimensions (mm)				(Refer.) Mass Open type (kg)
d	D	B	r_{min}	C_r	C_{0r}			Grease lub.				Shielded	Non-contact sealed	Extremely light contact sealed	Contact sealed	d_a min.	d_a max.	D_a max.	r_a max.	
								[Z, ZZ] [RU, 2RU]	(RD, 2RD)	(RS, 2RS)										
20	52	15	1.1	19.9	7.85	0.660	12.3	14 000	13 000	9 500	17 000	6304 ZZ	6304 2RU	6304 2RD	6304 2RS	26.5	27	45.5	1	0.144
22	44	12	0.6	11.7	5.15	0.350	14.1	17 000	15 000	9 900	20 000	60/22 ZZ	60/22 2RU	60/22 2RD	60/22 2RS	26	26.5	40	0.6	0.073
	50	14	1	16.0	6.65	0.510	13.2	15 000	14 000	9 700	17 000	62/22 ZZ	62/22 2RU	62/22 2RD	62/22 2RS	27	27	45	1	0.118
	56	16	1.1	23.1	9.40	0.770	12.6	13 000	12 000	8 600	15 000	63/22 ZZ	63/22 2RU	63/22 2RD	63/22 2RS	28.5	29	49.5	1	0.201
25	32	4	0.2	1.35	0.840	0.035	15.8	19 000	—	10 000	22 000	6705 ZZ	6705 2RU	—	6705 2RS	26.6	—	30.4	0.2	0.006
	37	7	0.3	5.40	2.95	0.120	16.0	18 000	—	10 000	21 000	6805 ZZ	6805 2RU	—	6805 2RS	27	27.5	35	0.3	0.022
	42	9	0.3	8.75	4.55	0.230	15.4	16 000	14 000	9 300	19 000	6905 ZZ	6905 2RU	6905 2RD	6905 2RS	27	29	40	0.3	0.041
	47	12	0.6	12.6	5.85	0.380	14.5	15 000	14 000	9 000	18 000	6005 ZZ	6005 2RU	6005 2RD	6005 2RS	29	29.5	43	0.6	0.080
	52	15	1	17.5	7.85	0.550	13.9	13 000	12 000	8 400	15 000	6205 ZZ	6205 2RU	6205 2RD	6205 2RS	30	31.5	47	1	0.128
	62	17	1.1	25.7	11.3	0.860	13.2	11 000	9 900	7 500	13 000	6305 ZZ	6305 2RU	6305 2RD	6305 2RS	31.5	34	55.5	1	0.232
28	52	12	0.6	15.6	7.40	0.480	14.5	14 000	13 000	8 100	16 000	60/28 ZZ	60/28 2RU	60/28 2RD	60/28 2RS1	32	33	48	0.6	0.097
	58	16	1	22.4	9.75	0.720	13.4	12 000	11 000	7 600	14 000	62/28 ZZ	62/28 2RU	62/28 2RD	62/28 2RS	33	35	53	1	0.173
	68	18	1.1	29.4	13.1	0.990	13.3	10 000	9 000	6 900	12 000	63/28 ZZ	63/28 2RU	63/28 2RD	63/28 2RS	34.5	37.5	61.5	1	0.328
30	37	4	0.2	1.45	0.950	0.040	15.7	16 000	—	8 800	19 000	6706 ZZ	6706 2RU	—	6706 2RS	31.6	—	35.4	0.2	0.008
	42	7	0.3	5.65	3.40	0.140	16.4	15 000	—	8 600	18 000	6806 ZZ	6806 2RU	—	6806 2RS	32	32.5	40	0.3	0.026
	47	9	0.3	9.05	5.00	0.260	15.8	14 000	13 000	8 200	17 000	6906 ZZ	6906 2RU	6906 2RD	6906 2RS	32	33	45	0.3	0.045
	55	13	1	16.5	8.25	0.530	14.7	13 000	12 000	7 500	15 000	6006 ZZ	6006 2RU	6006 2RD	6006 2RS	35	36	50	1	0.116
	62	16	1	24.3	11.3	0.800	13.9	11 000	9 900	7 000	13 000	6206 ZZ	6206 2RU	6206 2RD	6206 2RS	35	37.5	57	1	0.199
	72	19	1.1	33.3	15.0	1.15	13.3	9 600	8 600	6 400	12 000	6306 ZZ	6306 2RU	6306 2RD	6306 2RS	36.5	40	65.5	1	0.346
32	58	13	1	18.8	9.15	0.600	14.5	12 000	11 000	7 200	14 000	60/32 ZZ	60/32 2RU	60/32 2RD	60/32 2RS	37	38	53	1	0.127
	65	17	1	29.4	13.1	0.990	13.3	10 000	9 000	6 900	12 000	62/32 ZZ	62/32 2RU	62/32 2RD	62/32 2RS	37	38.5	60	1	0.228
	75	20	1.1	37.6	16.2	1.30	12.7	9 300	8 400	6 400	11 000	63/32 ZZ	63/32 2RU	63/32 2RD	63/32 2RS	38.5	41	68.5	1	0.437
35	47	7	0.3	5.95	3.85	0.160	16.5	13 000	—	7 400	16 000	6807 ZZ	6807 2RU	—	6807 2RS	37	37.5	45	0.3	0.030
	55	10	0.6	13.6	7.75	0.440	15.7	12 000	11 000	6 800	14 000	6907 ZZ	6907 2RU	6907 2RD	6907 2RS	39	40	51	0.6	0.073
	62	14	1	19.9	10.3	0.640	14.9	11 000	9 900	6 500	13 000	6007 ZZ	6007 2RU	6007 2RD	6007 2RS	40	42	58	1	0.155
	72	17	1.1	32.1	15.4	1.10	13.9	9 200	8 300	6 000	11 000	6207 ZZ	6207 2RU	6207 2RD	6207 2RS	41.5	43.5	65.5	1	0.288
	80	21	1.5	41.7	19.3	1.45	13.2	8 500	7 700	5 700	10 000	6307 ZZ	6307 2RU	6307 2RD	6307 2RS	43	46	72	1.5	0.457

[Remark] Standard cage types used for the above bearings are described earlier in this section.

Single-row deep groove ball bearings
shielded type
sealed type

d 40 ~ (65) mm



Boundary dimensions (mm)				Basic load ratings (kN)		Fatigue load limit (kN) C_u	Factor f_0	Limiting speeds (min^{-1})				Bearing No.	Mounting dimensions (mm)				(Refer.) Mass Open type (kg)			
d	D	B	r_{min}	C_r	C_{0r}			Grease lub.		Oil lub.			Shielded	Non-contact sealed	Extremely light contact sealed	Contact sealed		d_a		D_a max.
						[Z, ZZ] [RU, 2RU]	(RD, 2RD)	(RS, 2RS)	(Z)	min.	max.									
40	52	7	0.3	6.15	4.20	0.180	16.3	12 000	11 000	6 700	14 000	6808 ZZ	6808 2RU	6808 2RD	6808 2RS	42	42	50	0.3	0.033
	62	12	0.6	17.1	9.95	0.570	15.6	11 000	9 900	6 100	13 000	6908 ZZ	6908 2RU	6908 2RD	6908 2RS	44	44.5	58	0.6	0.112
	68	15	1	20.9	11.5	0.690	15.2	10 000	9 000	5 800	12 000	6008 ZZ	6008 2RU	6008 2RD	6008 2RS	45	46.5	63	1	0.192
	80	18	1.1	36.4	17.8	1.25	14.0	8 300	7 500	5 400	10 000	6208 ZZ	6208 2RU	6208 2RD	6208 2RS	46.5	49	73.5	1	0.366
	90	23	1.5	50.9	24.0	1.85	13.2	7 700	6 900	5 100	9 200	6308 ZZ	6308 2RU	6308 2RD	6308 2RS	48	51.5	82	1.5	0.633
45	58	7	0.3	7.75	5.40	0.230	16.3	11 000	9 900	5 900	13 000	6809 ZZ	6809 2RU	6809 2RD	6809 2RS	47	47	56	0.3	0.040
	68	12	0.6	17.7	10.9	0.600	15.9	9 700	8 700	5 500	11 000	6909 ZZ	6909 2RU	6909 2RD	6909 2RS	49	50	64	0.6	0.132
	75	16	1	26.2	15.1	0.900	15.3	9 200	8 300	5 300	11 000	6009 ZZ	6009 2RU	6009 2RD	6009 2RS	50	51.5	70	1	0.245
	85	19	1.1	40.9	20.3	1.40	14.0	7 700	6 900	5 100	9 200	6209 ZZ	6209 2RU	6209 2RD	6209 2RS	51.5	53.5	78.5	1	0.407
	100	25	1.5	61.1	29.5	2.25	13.3	6 800	6 100	4 500	8 100	6309 ZZ	6309 2RU	6309 2RD	6309 2RS	53	59.5	92	1.5	0.833
50	65	7	0.3	8.20	6.10	0.260	16.1	9 600	8 600	5 200	11 000	6810 ZZ	6810 2RU	6810 2RD	6810 2RS	52	53	63	0.3	0.052
	72	12	0.6	18.2	11.7	0.640	16.1	9 000	—	5 000	11 000	6910 ZZ	6910 2RU	—	—	54	55.5	68	0.6	0.133
	80	16	1	27.3	16.6	0.960	15.6	8 400	7 600	4 800	9 900	6010 ZZ	6010 2RU	6010 2RD	6010 2RS	55	57	75	1	0.261
	90	20	1.1	43.9	23.3	1.55	14.4	7 100	6 400	4 600	8 500	6210 ZZ	6210 2RU	6210 2RD	6210 2RS	56.5	59	83.5	1	0.463
	110	27	2	77.5	38.3	2.90	13.2	6 100	5 500	4 100	7 300	6310 ZZ	6310 2RU	6310 2RD	6310 2RS	59	66.5	101	2	1.07
55	72	9	0.3	11.0	8.10	0.420	16.2	8 700	7 800	—	10 000	6811 ZZ	6811 2RU	6811 2RD	—	57	58.5	70	0.3	0.083
	80	13	1	20.8	14.1	0.760	16.2	8 100	7 300	4 500	9 600	6911 ZZ	6911 2RU	6911 2RD	6911 2RS	60	60.5	75	1	0.185
	90	18	1.1	35.3	21.2	1.25	15.3	7 600	6 800	4 300	8 900	6011 ZZ	6011 2RU	6011 2RD	6011 2RS	61.5	62	83.5	1	0.385
	100	21	1.5	54.2	29.4	1.95	14.4	6 300	5 700	4 100	7 600	6211 ZZ	6211 2RU	6211 2RD	6211 2RS	63	66	92	1.5	0.607
	120	29	2	89.5	45.0	3.45	13.2	5 600	—	3 700	6 700	6311 ZZ	6311 2RU	—	6311 2RS	64	74.5	111	2	1.37
60	78	10	0.3	14.3	10.6	0.550	16.3	8 000	7 200	—	9 400	6812 ZZ	6812 2RU	6812 2RD	—	62	63	76	0.3	0.104
	85	13	1	25.2	17.3	0.940	16.2	7 500	—	—	8 900	6912 ZZ	6912 2RU	—	—	65	66	80	1	0.192
	95	18	1.1	36.8	23.2	1.35	15.6	7 100	—	4 000	8 400	6012 ZZ	6012 2RU	—	6012 2RS	66.5	68.5	88.5	1	0.415
	110	22	1.5	65.6	36.2	2.40	14.4	5 700	5 100	3 700	6 900	6212 ZZ	6212 2RU	6212 2RD	6212 2RS	68	72.5	102	1.5	0.783
	130	31	2.1	102	52.2	3.95	13.2	5 200	—	3 500	6 200	6312 ZZ	6312 2RU	—	6312 2RS	71	80	119	2	1.70
65	85	10	0.6	14.9	11.5	0.590	16.2	7 300	6 600	—	8 600	6813 ZZ	6813 2RU	6813 2RD	—	69	69	81	0.6	0.126
	90	13	1	21.7	16.1	0.830	16.6	7 100	6 400	3 900	8 400	6913 ZZ	6913 2RU	6913 2RD	6913 2RS	70	71	85	1	0.211

[Remark] Standard cage types used for the above bearings are described earlier in this section.

Single-row deep groove ball bearings
shielded type
sealed type

d (65) ~ (90) mm



Shielded

Non-contact sealed

Extremely light contact sealed

Contact sealed

Boundary dimensions (mm)				Basic load ratings (kN)		Fatigue load limit (kN) C_u	Factor f_0	Limiting speeds (min^{-1})			Bearing No.	Mounting dimensions (mm)			(Refer.) Mass Open type (kg)					
d	D	B	$r_{\text{min.}}$	C_r	C_{0r}			Grease lub.		Oil lub.		Shielded	Non-contact sealed	Extremely light contact sealed		Contact sealed	d_a min.	d_a max.	D_a max.	r_a max.
								[Z, ZZ] [RU, 2RU]	(RD, 2RD)	(RS, 2RS)	(Z)									
65	100	18	1.1	38.1	25.2	1.40	15.8	6 600	—	3 700	7 800	6013 ZZ	6013 2RU	—	6013 2RS	71.5	74.5	93.5	1	0.435
	120	23	1.5	71.5	40.1	2.65	14.4	5 400	—	3 500	6 400	6213 ZZ	6213 2RU	—	6213 2RS	73	79	112	1.5	0.990
	140	33	2.1	116	59.9	4.50	13.2	4 800	—	3 200	5 800	6313 ZZ	6313 2RU	—	6313 2RS	76	86	129	2	2.08
70	90	10	0.6	15.1	11.9	0.620	16.1	6 800	6 100	—	8 100	6814 ZZ	6814 2RU	6814 2RD	—	74	74	86	0.6	0.134
	100	16	1	29.7	21.2	1.10	16.3	6 400	5 800	3 600	7 600	6914 ZZ	6914 2RU	6914 2RD	6914 2RS	75	76.5	95	1	0.342
	110	20	1.1	47.6	30.9	1.80	15.6	6 100	—	3 500	7 200	6014 ZZ	6014 2RU	—	6014 2RS	76.5	79.5	103.5	1	0.602
	125	24	1.5	77.8	44.1	2.90	14.5	5 100	—	3 300	6 100	6214 ZZ	6214 2RU	—	6214 2RS	78	84	117	1.5	1.07
	150	35	2.1	130	68.2	4.95	13.2	4 500	—	3 000	5 400	6314 ZZ	6314 2RU	—	6314 2RS	81	92	139	2	2.52
75	95	10	0.6	15.7	12.9	0.660	16.0	6 400	5 800	—	7 600	6815 ZZ	6815 2RU	6815 2RD	—	79	79	91	0.6	0.142
	105	16	1	30.5	22.6	1.20	16.5	6 100	—	—	7 200	6915 ZZ	6915 2RU	—	—	80	82.5	100	1	0.363
	115	20	1.1	49.4	33.5	1.90	15.8	5 700	—	3 300	6 800	6015 ZZ	6015 2RU	—	6015 2RS	81.5	84.5	108.5	1	0.638
	130	25	1.5	84.3	48.3	3.10	14.5	4 800	—	3 100	5 800	6215 ZZ	6215 2RU	—	6215 2RS	83	88.5	122	1.5	1.18
	160	37	2.1	142	77.2	5.40	13.2	4 200	—	2 800	5 000	6315 ZZ	6315 2RU	—	6315 2RS	86	97.5	149	2	3.02
80	100	10	0.6	15.9	13.3	0.690	16.0	6 100	5 500	—	7 200	6816 ZZ	6816 2RU	6816 2RD	—	84	84	96	0.6	0.150
	110	16	1	31.2	24.0	1.25	16.6	5 700	5 100	3 200	6 800	6916 ZZ	6916 2RU	6916 2RD	6916 2RS	85	86.5	105	1	0.382
	125	22	1.1	59.5	39.8	2.25	15.6	5 300	—	3 100	6 300	6016 ZZ	6016 2RU	—	6016 2RS	86.5	90	118.5	1	0.850
	140	26	2	90.9	53.0	3.25	14.6	4 500	—	2 900	5 400	6216 ZZ	6216 2RU	—	6216 2RS	89	93	131	2	1.40
	170	39	2.1	154	86.7	5.85	13.3	3 900	—	2 700	4 700	6316 ZZ	6316 2RU	—	6316 2RS	91	105	159	2	3.59
85	110	13	1	23.4	19.0	0.980	16.2	5 600	5 000	—	6 600	6817 ZZ	6817 2RU	6817 2RD	—	90	90.5	105	1	0.266
	120	18	1.1	39.9	29.6	1.55	16.4	5 300	4 800	3 000	6 300	6917 ZZ	6917 2RU	6917 2RD	6917 2RS	91.5	92.5	113.5	1	0.535
	130	22	1.1	61.8	43.1	2.35	15.8	5 000	—	2 900	5 900	6017 ZZ	6017 2RU	—	6017 2RS	91.5	96.5	123.5	1	0.890
	150	28	2	105	61.9	3.70	14.5	4 200	—	2 700	5 000	6217 ZZ	6217 2RU	—	6217 2RS	94	102	141	2	1.79
	180	41	3	166	96.8	6.35	13.3	3 700	—	2 500	4 400	6317 ZZ	6317 2RU	—	6317 2RS	98	111	167	2.5	4.23
90	115	13	1	23.8	19.7	1.00	16.1	5 300	4 800	—	6 300	6818 ZZ	6818 2RU	6818 2RD	—	95	95.5	110	1	0.279
	125	18	1.1	41.0	31.6	1.60	16.5	5 100	4 600	2 800	6 000	6918 ZZ	6918 2RU	6918 2RD	6918 2RS	96.5	97.5	118.5	1	0.565
	140	24	1.5	72.8	49.7	2.65	15.6	4 700	—	2 700	5 600	6018 ZZ	6018 2RU	—	6018 2RS	98	100.5	132	1.5	1.16
	160	30	2	120	71.5	4.20	14.5	3 900	—	2 600	4 700	6218 ZZ	6218 2RU	—	6218 2RS	99	108.5	151	2	2.15

[Remark] Standard cage types used for the above bearings are described earlier in this section.

Single-row deep groove ball bearings
shielded type
sealed type

d (90) ~ (130) mm



Boundary dimensions (mm)				Basic load ratings (kN)		Fatigue load limit (kN) C_u	Factor f_0	Limiting speeds (min^{-1})			Bearing No.	Mounting dimensions (mm)				(Refer.) Mass Open type (kg)				
d	D	B	$r_{\text{min.}}$	C_r	C_{0r}			Grease lub.		Oil lub.		Shielded	Non-contact sealed	Extremely light contact sealed	Contact sealed		d_a min.	d_a max.	D_a max.	r_a max.
								[Z, ZZ] [RU, 2RU]	(RD, 2RD)	(RS, 2RS)	(Z)									
90	190	43	3	178	107	8.80	13.3	3 500	—	2 400	4 200	6318 ZZX	6318 2RU	—	6318 2RS	103	117	177	2.5	4.91
95	130	18	1.1	42.1	33.5	1.65	16.6	4 800	4 300	2 700	5 700	6919 ZZ	6919 2RU	6919 2RD	6919 2RS	101.5	102	123.5	1	0.705
	145	24	1.5	75.5	53.9	2.75	15.8	4 400	—	2 500	5 200	6019 ZZX	6019 2RU	—	6019 2RS	103	107.5	137	1.5	1.21
	170	32	2.1	136	81.9	4.65	14.4	3 700	—	2 400	4 400	6219 ZZX	6219 2RU	—	6219 2RS	106	113	159	2	2.62
	200	45	3	191	119	9.45	13.3	3 300	—	2 200	4 000	6319 ZZX	6319 2RU	—	6319 2RS	108	122	187	2.5	5.67
100	125	13	1	24.5	21.2	1.05	16.0	4 800	4 300	—	5 700	6820 ZZ	6820 2RU	6820 2RD	—	105	105.5	120	1	0.309
	140	20	1.1	51.5	39.6	1.90	16.2	4 500	—	—	5 300	6920-1 ZZ	6920-1 2RU	—	—	106.5	110.5	133.5	1	0.960
	150	24	1.5	75.2	54.2	2.70	15.9	4 300	—	2 500	5 100	6020 ZZ	6020 2RU	—	6020 2RS	108	112	142	1.5	1.25
	180	34	2.1	153	93.1	5.15	14.4	3 500	—	2 300	4 200	6220 ZZX	6220 2RU	—	6220 2RS	111	122	169	2	3.14
	215	47	3	216	141	10.9	13.2	3 000	—	2 100	3 600	6320 ZZX	6320 2RU	—	6320 2RS	113	131	202	2.5	7.00
105	145	20	1.1	53.0	42.1	1.95	16.4	4 300	—	2 400	5 100	6921-1 ZZ	6921-1 2RU	—	6921-1 2RS	111.5	115	138.5	1	1.00
	160	26	2	90.4	65.8	3.20	15.8	4 000	—	2 300	4 700	6021 ZZX	6021 2RU	—	6021 2RS	114	119	151	2	1.59
	190	36	2.1	166	105	5.70	14.4	3 300	—	2 200	3 900	6221 ZZX	6221 2RU	—	6221 2RS	116	127	179	2	3.70
	225	49	3	230	153	11.7	13.2	2 900	—	2 000	3 500	6321 ZZX	6321 2RU	—	6321 2RS	118	136	212	2.5	8.05
110	140	16	1	35.1	30.7	1.40	16.1	4 300	3 900	—	5 100	6822 ZZ	6822 2RU	6822 2RD	—	115	116.5	135	1	0.606
	150	20	1.1	59.9	47.8	2.20	16.4	4 100	—	—	4 900	6922 ZZ	6922 2RU	—	—	116.5	119.5	143.5	1	1.04
	170	28	2	103	73.0	3.55	15.6	3 800	—	2 200	4 500	6022 ZZX	6022 2RU	—	6022 2RS	119	123	161	2	1.96
	200	38	2.1	180	117	6.20	14.4	3 100	—	2 000	3 700	6222 ZZX	6222 2RU	—	6222 2RS	121	136.5	189	2	4.36
	240	50	3	257	180	13.3	13.2	2 700	—	1 900	3 200	6322 ZZX	6322 2RU	—	6322 2RS	123	146.5	227	2.5	9.54
120	150	16	1	36.2	33.0	1.45	16.0	4 000	—	—	4 700	6824 ZZ	6824 2RU	—	—	125	128.5	145	1	0.655
	165	22	1.1	71.6	56.9	2.50	16.4	3 800	—	—	4 400	6924 ZZ	6924 2RU	—	—	126.5	131.5	158.5	1	1.41
	180	28	2	106	79.3	3.60	15.9	3 600	—	2 100	4 200	6024 ZZX	6024 2RU	—	6024 2RS	129	136	171	2	2.07
	215	40	2.1	194	131	6.65	14.4	2 900	—	1 900	3 400	6224 ZZX	6224 2RU	—	6224 2RS	131	144	204	2	5.15
	260	55	3	258	185	12.6	13.5	2 500	—	—	3 000	6324 ZZX	—	—	—	133	158	247	2.5	12.5
130	165	18	1.1	46.1	41.2	1.75	16.1	3 600	—	—	4 300	6826 ZZ	6826 2RU	—	—	136.5	139.5	158.5	1	0.939
	180	24	1.5	81.5	67.4	2.85	16.3	3 400	—	—	4 100	6926-1 ZZ	6926-1 2RU	—	—	138	144	172	1.5	1.86

[Remark] Standard cage types used for the above bearings are described earlier in this section.

Single-row deep groove ball bearings shielded type sealed type

d (130) ~ 220 mm



Boundary dimensions (mm)				Basic load ratings (kN)		Fatigue load limit (kN) C_u	Factor f_0	Limiting speeds (min^{-1})				Bearing No.				Mounting dimensions (mm)				(Refer.) Mass Open type (kg)	
d	D	B	$r_{\text{min.}}$	C_r	C_{0r}			Grease lub.		Oil lub.		Shielded	Non-contact sealed	Extremely light contact sealed	Contact sealed	d_a min.	d_a max.	D_a max.	r_a max.		
								[Z, ZZ] [RU, 2RU]	(RD, 2RD)	(RS, 2RS)	(Z)										
130	200	33	2	133	101	4.45	15.8	3 200	—	1 900	3 800		6026 ZZ	6026 2RU	—	6026 2RS	139	146.5	191	2	3.16
	230	40	3	209	146	9.15	14.5	2 700	—	1 800	3 200		6226 ZZ	6226 2RU	—	6226 2RS	143	157	217	2.5	5.82
	280	58	4	287	214	14.1	13.6	2 300	—	—	2 700		6326 ZZ	—	—	—	146	171	264	3	15.1
140	175	18	1.1	47.8	44.4	1.85	16.0	3 400	3 100	—	4 000		6828 ZZ	—	6828 2RD	—	146.5	148	168.5	1	1.00
	190	24	1.5	83.3	71.6	2.90	16.5	3 200	—	—	3 800		6928-1 ZZ	6928-1 2RU	—	—	148	153	182	1.5	1.98
	210	33	2	137	109	4.55	15.9	3 000	—	1 800	3 600		6028 ZZ	6028 2RU	—	6028 2RS	149	158.5	201	2	3.55
	250	42	3	208	150	8.65	14.8	2 400	—	1 600	2 900		6228 ZZ	6228 2RU	—	6228 2RS	153	169	237	2.5	7.45
	300	62	4	316	246	15.6	13.6	2 100	—	—	2 500		6328 ZZ	—	—	—	156	184	284	3	19.4
150	210	28	2	117	94.3	3.75	16.2	2 900	—	1 700	3 400		6930 ZZ	6930 2RU	—	6930 2RS	159	165.5	201	2	3.05
	225	35	2.1	157	126	5.10	16.0	2 800	—	1 600	3 300		6030 ZZ	6030 2RU	—	6030 2RS	161	168.5	214	2	4.22
	270	45	3	220	168	9.05	15.1	2 200	—	—	2 700		6230 ZZ	—	—	—	163	183.5	257	2.5	9.41
160	200	20	1.1	60.5	56.9	2.20	16.1	2 900	2 600	—	3 400		6832 ZZ	—	6832 2RD	—	166.5	168.5	193.5	1	1.45
	240	38	2.1	171	135	5.30	15.9	2 600	—	1 500	3 000		6032 ZZ	6032 2RU	—	6032 2RS	171	178.5	229	2	5.22
	290	48	3	231	186	9.45	15.4	2 100	—	—	2 500		6232 ZZ	—	—	—	173	198	277	2.5	14.3
170	215	22	1.1	74.8	70.5	2.60	16.1	2 700	—	—	3 200		6834 ZZ	—	—	—	176.5	182.5	208.5	1	1.90
	260	42	2.1	201	161	6.20	15.8	2 400	—	—	2 800		6034 ZZ	6034 2RU	—	—	181	194	249	2	6.80
	310	52	4	265	223	11.1	15.3	1 900	—	—	2 300		6234 ZZ	—	—	—	186	210.5	294	3	17.5
180	225	22	1.1	75.8	73.1	2.65	16.1	2 600	2 300	—	3 000		6836 ZZ	—	6836 2RD	—	186.5	189.5	218.5	1	2.00
	280	46	2.1	227	194	7.15	15.8	2 200	—	—	2 600		6036 ZZ	6036 2RU	—	—	191	209.5	269	2	10.3
	320	52	4	264	226	10.8	15.1	1 800	—	—	2 200		6236-1 ZZ	—	—	—	196	220.5	304	3	18.3
190	240	24	1.5	91.4	88.1	3.10	16.1	2 400	—	—	2 800		6838 ZZ	—	—	—	198	202	232	1.5	2.60
	290	46	2.1	235	201	7.35	15.8	2 100	—	—	2 500		6038 ZZ	—	—	—	201	215	279	2	10.8
200	310	51	2.1	272	243	11.3	15.6	1 900	—	—	2 300		6040 ZZ	—	—	—	211	228	299	2	14.0
	360	58	4	314	293	13.1	15.2	1 600	—	—	1 900		6240-1 ZZ	—	—	—	216	250	344	3	28.2
220	340	56	3	294	271	12.0	15.6	1 700	—	—	2 000		6044 ZZ	—	—	—	233	251	327	2.5	18.3

[Remark] Standard cage types used for the above bearings are described earlier in this section.

Single-row deep groove ball bearings
snap ring groove type
locating snap ring type

d 10 ~ (28) mm

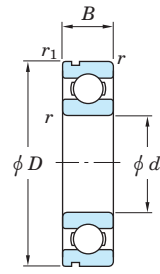

N
With snap ring groove

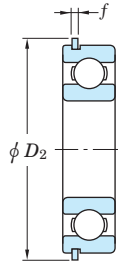

NR
With locating snap ring

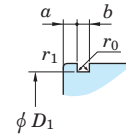

Snap ring groove details

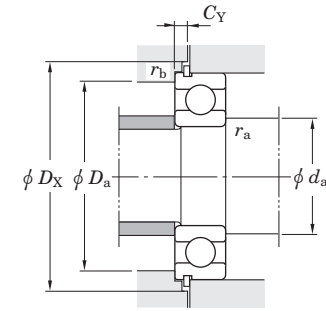

With locating snap ring and one shield

Boundary dimensions (mm)					Basic load ratings (kN)		Fatigue load limit	Factor	Limiting speeds (min ⁻¹)		Bearing No.		Dimensions of snap ring groove (mm)				Dimensions of locating snap ring (mm)		Mounting dimensions (mm)						(Refer.) Mass (kg)	(Refer.) Bearing No.
d	D	B	r min.	r1 min.	C _r	C _{0r}	C _u	f ₀	Grease lub.	Oil lub.	With snap ring groove	With locating snap ring	D ₁ max.	a max.	b ±0.15	r ₀ max.	D ₂ max.	f ±0.05	d _a min.	D _a max.	D _X min.	C _Y max.	r _a max.	r _b max.		
10	22	6	0.3	0.3	3.35	1.25	0.070	14.0	34 000	41 000	6900N	6900NR	20.8	1.05	0.925 ¹⁾	0.2	24.8	0.65	12	20	25.5	1.5	0.3	0.3	0.010	6900N
	30	9	0.6	0.3	6.40	2.40	0.120	13.2	24 000	29 000	6200N	6200NR	28.17	2.06	1.5	0.4	34.7	1.07	14	26	35.5	2.92	0.6	0.3	0.032	6200N
	35	11	0.6	0.5	10.1	3.45	0.270	11.2	22 000	27 000	6300N	6300NR	33.17	2.06	1.5	0.4	39.7	1.07	14	31	40.5	2.92	0.6	0.5	0.053	6300N
12	24	6	0.3	0.3	3.60	1.45	0.080	14.5	31 000	36 000	6901N	6901NR	22.8	1.05	0.925 ¹⁾	0.2	26.8	0.65	14	22	27.5	1.5	0.3	0.3	0.011	6901N
	32	10	0.6	0.3	8.50	3.05	0.240	12.3	22 000	27 000	6201N	6201NR	30.15	2.06	1.5	0.4	36.7	1.07	16	28	37.5	2.92	0.6	0.3	0.037	6201N
	37	12	1	0.5	12.1	4.20	0.420	11.1	20 000	25 000	6301N	6301NR	34.77	2.06	1.5	0.4	41.3	1.07	17	32	42	2.92	1	0.5	0.060	6301N
15	28	7	0.3	0.3	5.40	2.25	0.120	14.3	26 000	30 000	6902N	6902NR	26.7	1.3	1.075 ¹⁾	0.25	30.8	0.8	17	26	31.5	1.9	0.3	0.3	0.017	6902N
	35	11	0.6	0.5	9.55	3.75	0.290	13.2	20 000	24 000	6202N	6202NR	33.17	2.06	1.5	0.4	39.7	1.07	19	31	40.5	2.92	0.6	0.5	0.045	6202N
	42	13	1	0.5	14.3	5.45	0.460	12.3	17 000	20 000	6302N	6302NR	39.75	2.06	1.5	0.4	46.3	1.07	20	37	47	2.92	1	0.5	0.082	6302N
17	30	7	0.3	0.3	5.75	2.55	0.130	14.7	23 000	28 000	6903N	6903NR	28.7	1.3	1.075 ¹⁾	0.25	32.8	0.8	19	28	33.5	1.9	0.3	0.3	0.018	6903N
	40	12	0.6	0.5	12.0	4.80	0.370	13.2	17 000	21 000	6203N	6203NR	38.1	2.06	1.5	0.4	44.6	1.07	21	36	45.5	2.92	0.6	0.5	0.065	6203N
	47	14	1	0.5	17.0	6.65	0.550	12.4	15 000	18 000	6303N	6303NR	44.6	2.46	1.5	0.4	52.7	1.07	22	42	53.5	3.33	1	0.5	0.115	6303N
20	32	7	0.3	0.3	5.00	2.45	0.100	15.5	21 000	25 000	6804N	6804NR	30.7	1.3	1.075 ¹⁾	0.25	34.8	0.8	22	30	35.5	1.9	0.3	0.3	0.018	6804N
	37	9	0.3	0.3	7.95	3.70	0.190	14.7	19 000	23 000	6904N	6904NR	35.7	1.7	1.075 ¹⁾	0.25	39.8	0.8	22	35	40.5	2.3	0.3	0.3	0.036	6904N
	42	12	0.6	0.5	11.7	5.05	0.350	13.9	17 000	21 000	6004N	6004NR	39.75	2.06	1.5	0.4	46.3	1.07	24	38	47	2.92	0.6	0.5	0.069	6004N
	47	14	1	0.5	16.0	6.65	0.510	13.2	15 000	17 000	6204N	6204NR	44.6	2.46	1.5	0.4	52.7	1.07	25	42	53.5	3.33	1	0.5	0.106	6204N
22	52	15	1.1	0.5	19.9	7.85	0.660	12.3	14 000	17 000	6304N	6304NR	49.73	2.46	1.5	0.4	57.9	1.07	26.5	45.5	58.5	3.33	1	0.5	0.144	6304N
	44	12	0.6	0.5	11.7	5.15	0.350	14.1	17 000	20 000	60/22N	60/22NR	41.75	2.06	1.5	0.4	48.3	1.07	26	40	49	2.92	0.6	0.5	0.073	60/22N
	50	14	1	0.5	16.0	6.65	0.510	13.2	15 000	17 000	62/22N	62/22NR	47.6	2.46	1.5	0.4	55.7	1.07	27	45	56.5	3.33	1	0.5	0.118	62/22N
25	56	16	1.1	0.5	23.1	9.40	0.770	12.6	13 000	15 000	63/22N	63/22NR	53.6	2.46	1.5	0.4	61.7	1.07	28.5	49.5	62.5	3.33	1	0.5	0.201	63/22N
	37	7	0.3	0.3	5.40	2.95	0.120	16.0	18 000	21 000	6805N	6805NR	35.7	1.3	1.075 ¹⁾	0.25	39.8	0.8	27	35	40.5	1.9	0.3	0.3	0.022	6805N
	42	9	0.3	0.3	8.75	4.55	0.230	15.4	16 000	19 000	6905N	6905NR	40.7	1.7	1.075 ¹⁾	0.25	44.8	0.8	27	40	45.5	2.3	0.3	0.3	0.041	6905N
	47	12	0.6	0.5	12.6	5.85	0.380	14.5	15 000	18 000	6005N	6005NR	44.6	2.06	1.5	0.4	52.7	1.07	29	43	53.5	2.92	0.6	0.5	0.080	6005N
	52	15	1	0.5	17.5	7.85	0.550	13.9	13 000	15 000	6205N	6205NR	49.73	2.46	1.5	0.4	57.9	1.07	30	47	58.5	3.33	1	0.5	0.128	6205N
28	62	17	1.1	0.5	25.7	11.3	0.860	13.2	11 000	13 000	6305N	6305NR	59.61	3.28	2.05	0.6	67.7	1.65	31.5	55.5	68.5	4.67	1	0.5	0.232	6305N
	52	12	0.6	0.5	15.6	7.40	0.480	14.5	14 000	16 000	60/28N	60/28NR	49.73	2.06	1.5	0.4	57.9	1.07	32	48	58.5	2.92	0.6	0.5	0.097	60/28N
28	58	16	1	0.5	22.4	9.75	0.720	13.4	12 000	14 000	62/28N	62/28NR	55.6	2.46	1.5	0.4	63.7	1.07	33	53	64.5	3.33	1	0.5	0.173	62/28N

[Note] 1) The tolerance of the ring groove width is ±0.125.

[Remark] Standard cage types used for the above bearings are described earlier in this section.

Single-row deep groove ball bearings
snap ring groove type
locating snap ring type

d (28) ~ (50) mm

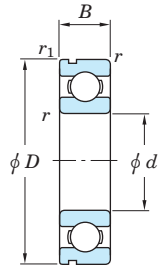

N
With snap ring groove

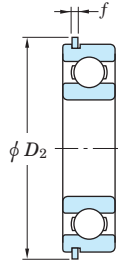

NR
With locating snap ring

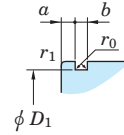

Snap ring groove details

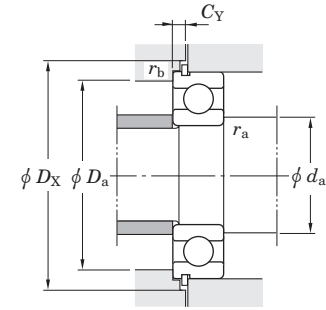

With locating snap ring and one shield

Boundary dimensions (mm)					Basic load ratings (kN)		Fatigue load limit	Factor	Limiting speeds (min ⁻¹)		Bearing No.		Dimensions of snap ring groove (mm)				Dimensions of locating snap ring (mm)		Mounting dimensions (mm)						(Refer.) Mass (kg)	(Refer.) Bearing No.
d	D	B	r min.	r1 min.	Cr	C0r	(kN) Cu	f0	Grease lub.	Oil lub.	With snap ring groove	With locating snap ring	D1 max.	a max.	b ±0.15	r0 max.	D2 max.	f ±0.05	da min.	Da max.	DX min.	CY max.	ra max.	rb max.		
28	68	18	1.1	0.5	29.4	13.1	0.990	13.3	10 000	12 000	63/28N	63/28NR	64.82	3.28	2.05	0.6	74.6	1.65	34.5	61.5	76	4.67	1	0.5	0.328	63/28N
30	42	7	0.3	0.3	5.65	3.40	0.140	16.4	15 000	18 000	6806N	6806NR	40.7	1.3	1.075 ¹⁾	0.25	44.8	0.8	32	40	45.5	1.9	0.3	0.3	0.026	6806N
	47	9	0.3	0.3	9.05	5.00	0.260	15.8	14 000	17 000	6906N	6906NR	45.7	1.7	1.075 ¹⁾	0.25	49.8	0.8	32	45	50.5	2.3	0.3	0.3	0.045	6906N
	55	13	1	0.5	16.5	8.25	0.530	14.7	13 000	15 000	6006N	6006NR	52.6	2.08	1.5	0.4	60.7	1.07	35	50	61.5	2.9	1	0.5	0.116	6006N
	62	16	1	0.5	24.3	11.3	0.800	13.9	11 000	13 000	6206N	6206NR	59.61	3.28	2.05	0.6	67.7	1.65	35	57	68.5	4.67	1	0.5	0.199	6206N
72	19	1.1	0.5	33.3	15.0	1.15	13.3	9 600	12 000	6306N	6306NR	68.81	3.28	2.05	0.6	78.6	1.65	36.5	65.5	80	4.67	1	0.5	0.346	6306N	
32	58	13	1	0.5	18.8	9.15	0.600	14.5	12 000	14 000	60/32N	60/32NR	55.6	2.08	1.5	0.4	63.7	1.07	37	53	64.5	2.9	1	0.5	0.127	60/32N
	65	17	1	0.5	29.4	13.1	0.990	13.3	10 000	12 000	62/32N	62/32NR	62.6	3.28	2.05	0.6	70.7	1.65	37	60	71.5	4.67	1	0.5	0.228	62/32N
	75	20	1.1	0.5	37.6	16.2	1.30	12.7	9 300	11 000	63/32N	63/32NR	71.83	3.28	2.05	0.6	81.6	1.65	38.5	68.5	83	4.67	1	0.5	0.437	63/32N
35	47	7	0.3	0.3	5.95	3.85	0.160	16.5	13 000	16 000	6807N	6807NR	45.7	1.3	1.075 ¹⁾	0.25	49.8	0.8	37	45	50.5	1.9	0.3	0.3	0.030	6807N
	55	10	0.6	0.6	13.6	7.75	0.440	15.7	12 000	14 000	6907N	6907NR	53.7	1.7	1.075 ¹⁾	0.25	57.8	0.8	39	51	58.5	2.3	0.6	0.6	0.073	6907N
	62	14	1	0.5	19.9	10.3	0.640	14.9	11 000	13 000	6007N	6007NR	59.61	2.08	2.05	0.6	67.7	1.65	40	58	68.5	3.48	1	0.5	0.155	6007N
	72	17	1.1	0.5	32.1	15.4	1.10	13.9	9 200	11 000	6207N	6207NR	68.81	3.28	2.05	0.6	78.6	1.65	41.5	65.5	80	4.67	1	0.5	0.288	6207N
	80	21	1.5	0.5	41.7	19.3	1.45	13.2	8 500	10 000	6307N	6307NR	76.81	3.28	2.05	0.6	86.6	1.65	43	72	88	4.67	1.5	0.5	0.457	6307N
40	52	7	0.3	0.3	6.15	4.20	0.180	16.3	12 000	14 000	6808N	6808NR	50.7	1.3	1.075 ¹⁾	0.25	54.8	0.8	42	50	55.5	1.9	0.3	0.3	0.033	6808N
	62	12	0.6	0.6	17.1	9.95	0.570	15.6	11 000	13 000	6908N	6908NR	60.7	1.7	1.075 ¹⁾	0.25	64.8	0.8	44	58	65.5	2.3	0.6	0.6	0.112	6908N
	68	15	1	0.5	20.9	11.5	0.690	15.2	10 000	12 000	6008N	6008NR	64.82	2.49	2.05	0.6	74.6	1.65	45	63	76	3.89	1	0.5	0.192	6008N
	80	18	1.1	0.5	36.4	17.8	1.25	14.0	8 300	10 000	6208N	6208NR	76.81	3.28	2.05	0.6	86.6	1.65	46.5	73.5	88	4.67	1	0.5	0.366	6208N
	90	23	1.5	0.5	50.9	24.0	1.85	13.2	7 700	9 200	6308N	6308NR	86.79	3.28	2.85	0.6	96.5	2.41	48	82	98	5.43	1.5	0.5	0.633	6308N
45	58	7	0.3	0.3	7.75	5.40	0.230	16.3	11 000	13 000	6809N	6809NR	56.7	1.3	1.075 ¹⁾	0.25	60.8	0.8	47	56	61.5	1.9	0.3	0.3	0.040	6809N
	68	12	0.6	0.6	17.7	10.9	0.600	15.9	9 700	11 000	6909N	6909NR	66.7	1.7	1.075 ¹⁾	0.25	70.8	0.8	49	64	72	2.3	0.6	0.6	0.132	6909N
	75	16	1	0.5	26.2	15.1	0.900	15.3	9 200	11 000	6009N	6009NR	71.83	2.49	2.05	0.6	81.6	1.65	50	70	83	3.89	1	0.5	0.245	6009N
	85	19	1.1	0.5	40.9	20.3	1.40	14.0	7 700	9 200	6209N	6209NR	81.81	3.28	2.05	0.6	91.6	1.65	51.5	78.5	93	4.67	1	0.5	0.407	6209N
	100	25	1.5	0.5	61.1	29.5	2.25	13.3	6 800	8 100	6309N	6309NR	96.8	3.28	2.85	0.6	106.5	2.41	53	92	108	5.43	1.5	0.5	0.833	6309N
50	65	7	0.3	0.3	8.20	6.10	0.260	16.1	9 600	11 000	6810N	6810NR	63.7	1.3	1.075 ¹⁾	0.25	67.8	0.8	52	63	68.5	1.9	0.3	0.3	0.052	6810N
	72	12	0.6	0.6	18.2	11.7	0.640	16.1	9 000	11 000	6910N	6910NR	70.7	1.7	1.075 ¹⁾	0.25	74.8	0.8	54	68	76	2.3	0.6	0.6	0.133	6910N
	80	16	1	0.5	27.3	16.6	0.960	15.6	8 400	9 900	6010N	6010NR	76.81	2.49	2.05	0.6	86.6	1.65	55	75	88	3.89	1	0.5	0.261	6010N

[Note] 1) The tolerance of the ring groove width is ±0.125.

[Remark] Standard cage types used for the above bearings are described earlier in this section.

Single-row deep groove ball bearings
snap ring groove type
locating snap ring type

d (50) ~ 90 mm

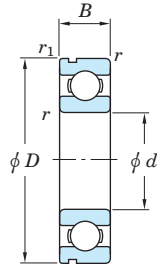

N
With snap ring groove

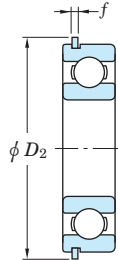

NR
With locating snap ring

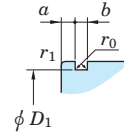

Snap ring groove details

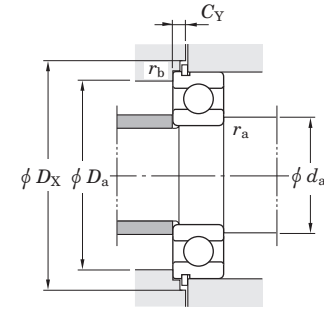

With locating snap ring and one shield

Boundary dimensions (mm)					Basic load ratings (kN)		Fatigue load limit	Factor	Limiting speeds (min ⁻¹)		Bearing No.		Dimensions of snap ring groove (mm)				Dimensions of locating snap ring (mm)		Mounting dimensions (mm)						(Refer.) Mass (kg)	(Refer.) Bearing No.
d	D	B	r min.	r1 min.	Cr	C0r	(kN) Cu	f0	Grease lub.	Oil lub.	With snap ring groove	With locating snap ring	D1 max.	a max.	b ±0.15	r0 max.	D2 max.	f ±0.05	da min.	Da max.	DX min.	CY max.	ra max.	rb max.		
50	90	20	1.1	0.5	43.9	23.3	1.55	14.4	7 100	8 500	6210N	6210NR	86.79	3.28	2.85	0.6	96.5	2.41	56.5	83.5	98	5.43	1	0.5	0.463	6210N
	110	27	2	0.5	77.5	38.3	2.90	13.2	6 100	7 300	6310N	6310NR	106.81	3.28	2.85	0.6	116.6	2.41	59	101	118	5.43	2	0.5	1.07	6310N
55	90	18	1.1	0.5	35.3	21.2	1.25	15.3	7 600	8 900	6011N	6011NR	86.79	2.87	2.85	0.6	96.5	2.41	61.5	83.5	98	5.03	1	0.5	0.385	6011N
	100	21	1.5	0.5	54.2	29.4	1.95	14.4	6 300	7 600	6211N	6211NR	96.8	3.28	2.85	0.6	106.5	2.41	63	92	108	5.43	1.5	0.5	0.607	6211N
	120	29	2	0.5	89.5	45.0	3.45	13.2	5 600	6 700	6311N	6311NR	115.21	4.06	3.25	0.6	129.7	2.77	64	111	131.5	6.58	2	0.5	1.37	6311N
60	95	18	1.1	0.5	36.8	23.2	1.35	15.6	7 100	8 400	6012N	6012NR	91.82	2.87	2.85	0.6	101.6	2.41	66.5	88.5	103	5.03	1	0.5	0.415	6012N
	110	22	1.5	0.5	65.6	36.2	2.40	14.4	5 700	6 900	6212N	6212NR	106.81	3.28	2.85	0.6	116.6	2.41	68	102	118	5.43	1.5	0.5	0.783	6212N
	130	31	2.1	0.5	102	52.2	3.95	13.2	5 200	6 200	6312N	6312NR	125.22	4.06	3.25	0.6	139.7	2.77	71	119	141.5	6.58	2	0.5	1.70	6312N
65	100	18	1.1	0.5	38.1	25.2	1.40	15.8	6 600	7 800	6013N	6013NR	96.8	2.87	2.85	0.6	106.5	2.41	71.5	93.5	108	5.03	1	0.5	0.435	6013N
	120	23	1.5	0.5	71.5	40.1	2.65	14.4	5 400	6 400	6213N	6213NR	115.21	4.06	3.25	0.6	129.7	2.77	73	112	131.5	6.58	1.5	0.5	0.990	6213N
	140	33	2.1	0.5	116	59.9	4.50	13.2	4 800	5 800	6313N	6313NR	135.23	4.9	3.25	0.6	149.7	2.77	76	129	152	7.37	2	0.5	2.08	6313N
70	110	20	1.1	0.5	47.6	30.9	1.80	15.6	6 100	7 200	6014N	6014NR	106.81	2.87	2.85	0.6	116.6	2.41	76.5	103.5	118	5.03	1	0.5	0.602	6014N
	125	24	1.5	0.5	77.8	44.1	2.90	14.5	5 100	6 100	6214N	6214NR	120.22	4.06	3.25	0.6	134.7	2.77	78	117	136.5	6.58	1.5	0.5	1.07	6214N
	150	35	2.1	0.5	130	68.2	4.95	13.2	4 500	5 400	6314N	6314NR	145.24	4.9	3.25	0.6	159.7	2.77	81	139	162	7.37	2	0.5	2.52	6314N
75	115	20	1.1	0.5	49.4	33.5	1.90	15.8	5 700	6 800	6015N	6015NR	111.81	2.87	2.85	0.6	121.6	2.41	81.5	108.5	123	5.03	1	0.5	0.638	6015N
	130	25	1.5	0.5	84.3	48.3	3.10	14.5	4 800	5 800	6215N	6215NR	125.22	4.06	3.25	0.6	139.7	2.77	83	122	141.5	6.58	1.5	0.5	1.18	6215N
	160	37	2.1	0.5	142	77.2	5.40	13.2	4 200	5 000	6315N	6315NR	155.22	4.9	3.25	0.6	169.7	2.77	86	149	172	7.37	2	0.5	3.02	6315N
80	125	22	1.1	0.5	59.5	39.8	2.25	15.6	5 300	6 300	6016N	6016NR	120.22	2.87	3.25	0.6	134.7	2.77	86.5	118.5	136.5	5.39	1	0.5	0.850	6016N
	140	26	2	0.5	90.9	53.0	3.25	14.6	4 500	5 400	6216N	6216NR	135.23	4.9	3.25	0.6	149.7	2.77	89	131	152	7.37	2	0.5	1.40	6216N
	170	39	2.1	0.5	154	86.7	5.85	13.3	3 900	4 700	6316N	6316NR	163.65	5.69	3.65	0.6	182.9	3.05	91	159	185	8.44	2	0.5	3.59	6316N
85	130	22	1.1	0.5	61.8	43.1	2.35	15.8	5 000	5 900	6017N	6017NR	125.22	2.87	3.25	0.6	139.7	2.77	91.5	123.5	141.5	5.39	1	0.5	0.890	6017N
	150	28	2	0.5	105	61.9	3.70	14.5	4 200	5 000	6217N	6217NR	145.24	4.9	3.25	0.6	159.7	2.77	94	141	162	7.37	2	0.5	1.79	6217N
	180	41	3	0.5	166	96.8	6.35	13.3	3 700	4 400	6317N	6317NR	173.66	5.69	3.65	0.6	192.9	3.05	98	167	195	8.44	2.5	0.5	4.23	6317N
90	140	24	1.5	0.5	72.8	49.7	2.65	15.6	4 700	5 600	6018N	6018NR	135.23	3.71	3.25	0.6	149.7	2.77	98	132	152	6.17	1.5	0.5	1.16	6018N
	160	30	2	0.5	120	71.5	4.20	14.5	3 900	4 700	6218N	6218NR	155.22	4.9	3.25	0.6	169.7	2.77	99	151	172	7.37	2	0.5	2.15	6218N
	190	43	3	0.5	178	107	8.80	13.3	3 500	4 200	6318N	6318NR	183.64	5.69	3.65	0.6	202.9	3.05	103	177	205	8.44	2.5	0.5	4.91	6318N

[Remark] Standard cage types used for the above bearings are described earlier in this section.

Single-row deep groove ball bearings
snap ring groove type
locating snap ring type

d 95 ~ 130 mm

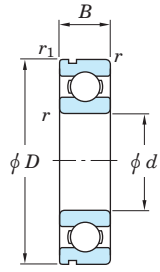

N
With snap ring groove

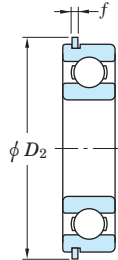

NR
With locating snap ring

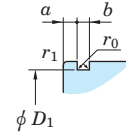

Snap ring groove details

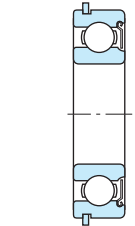
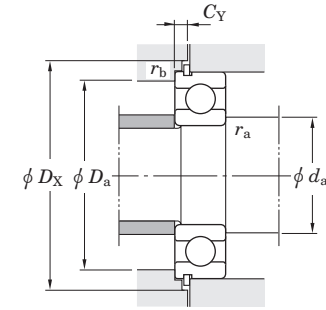

With locating snap ring and one shield

Boundary dimensions (mm)					Basic load ratings (kN)		Fatigue load limit	Factor	Limiting speeds (min ⁻¹)		Bearing No.		Dimensions of snap ring groove (mm)				Dimensions of locating snap ring (mm)		Mounting dimensions (mm)					(Refer.) Mass (kg)	(Refer.) Bearing No.	
d	D	B	r min.	r1 min.	Cr	C0r	(kN) Cu	f0	Grease lub.	Oil lub.	With snap ring groove	With locating snap ring	D1 max.	a max.	b ±0.15	r0 max.	D2 max.	f ±0.05	da min.	Da max.	DX min.	CY max.	ra max.	rb max.		
95	145	24	1.5	0.5	75.5	53.9	2.75	15.8	4 400	5 200	6019N	6019NR	140.23	3.71	3.25	0.6	154.7	2.77	103	137	157	6.17	1.5	0.5	1.21	6019N
	170	32	2.1	0.5	136	81.9	4.65	14.4	3 700	4 400	6219N	6219NR	163.65	5.69	3.65	0.6	182.9	3.05	106	159	185	8.44	2	0.5	2.62	6219N
	200	45	3	0.5	191	119	9.45	13.3	3 300	4 000	6319N	6319NR	193.65	5.69	3.65	0.6	212.9	3.05	108	187	215	8.44	2.5	0.5	5.67	6319N
100	150	24	1.5	0.5	75.2	54.2	2.70	15.9	4 300	5 100	6020N	6020NR	145.24	3.71	3.25	0.6	159.7	2.77	108	142	162	6.17	1.5	0.5	1.25	6020N
	180	34	2.1	0.5	153	93.1	5.15	14.4	3 500	4 200	6220N	6220NR	173.66	5.69	3.65	0.6	192.9	3.05	111	169	195	8.44	2	0.5	3.14	6220N
105	160	26	2	0.5	90.4	65.8	3.20	15.8	4 000	4 700	6021N	6021NR	155.22	3.71	3.25	0.6	169.7	2.77	114	151	172	6.17	2	0.5	1.59	6021N
	190	36	2.1	0.5	166	105	5.70	14.4	3 300	3 900	6221N	6221NR	183.64	5.69	3.65	0.6	202.9	3.05	116	179	205	8.44	2	0.5	3.70	6221N
110	170	28	2	0.5	103	73.0	3.55	15.6	3 800	4 500	6022N	6022NR	163.65	3.71	3.65	0.6	182.9	3.05	119	161	185	6.45	2	0.5	1.96	6022N
	200	38	2.1	0.5	180	117	6.20	14.4	3 100	3 700	6222N	6222NR	193.65	5.69	3.65	0.6	212.9	3.05	121	189	215	8.44	2	0.5	4.36	6222N
120	180	28	2	0.5	106	79.3	3.60	15.9	3 600	4 200	6024N	6024NR	173.66	3.71	3.65	0.6	192.9	3.05	129	171	195	6.45	2	0.5	2.07	6024N
130	200	33	2	0.5	133	101	4.45	15.8	3 200	3 800	6026N	6026NR	193.65	5.69	3.65	0.6	212.9	3.05	139	191	215	8.44	2	0.5	3.16	6026N

[Remark] Standard cage types used for the above bearings are described earlier in this section.

Extra-small ball bearings, miniature ball bearings

d 1 ~ (4) mm

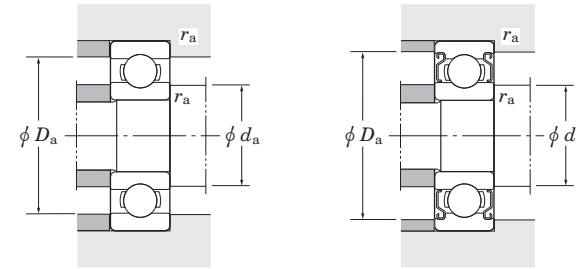
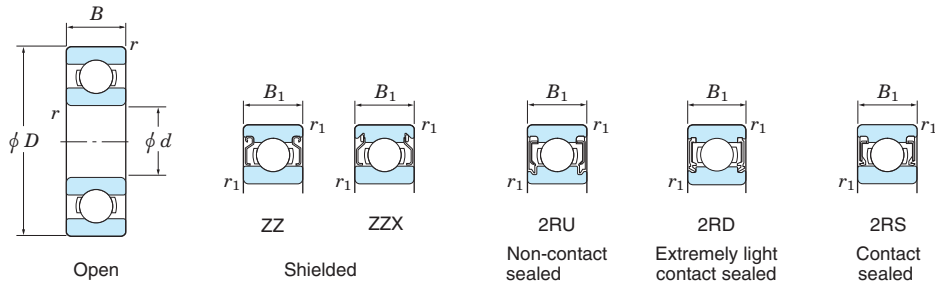

d	Boundary dimensions (mm)					Basic load ratings (kN)		Fatigue load limit (kN) C _u	Factor f ₀	Limiting speeds (min ⁻¹)				Bearing No.					Mounting dimensions (mm)			(Refer.) Mass (g)
	D	B	B ₁	r ¹⁾ _{min.}	r ¹⁾ _{min.}	C _r	C _{0r}			Grease lub.	Oil lub.	Open [ZZ, 2RU]	(2RD)	(2RS)	Open [Z]	Open	Shielded	Non-contact sealed	Extremely light shielded	Contact sealed	d _a min.	
1	3	1	—	0.07	—	0.120	0.03	0.0007	11.6	130 000	—	—	150 000	681	—	—	—	—	1.6	2.4	0.05	0.03
	3	1.5	—	0.08	—	0.100	0.02	0.0006	12.8	130 000	—	—	150 000	ML1003	—	—	—	—	1.6	2.4	0.07	0.05
	4	1.6	—	0.1	—	0.170	0.04	0.001	11.4	120 000	—	—	140 000	691	—	—	—	—	1.8	3.2	0.1	0.1
1.2	4	1.8	—	0.08	—	0.140	0.03	0.0009	11.4	120 000	—	—	140 000	ML1204	—	—	—	—	1.8	3.4	0.07	0.1
1.5	4	1.2	2	0.1	0.1	0.140	0.03	0.0009	13.2	120 000	—	—	140 000	68/1.5	W68/1.5 ZZ	—	—	—	2.3	3.2	0.1	0.1
	5	2	2.6	0.15	0.15	0.300	0.07	0.002	13.3	110 000	—	—	130 000	69/1.5	W69/1.5 ZZX	—	—	—	2.7	3.8	0.15	0.1
	6	2.5	3	0.1	0.1	0.410	0.10	0.003	11.4	86 000	—	—	100 000	ML1506	WML1506 ZZX	—	—	—	2.3	5.2	0.1	0.3
2	5	1.5	2.3	0.1	0.1	0.210	0.05	0.001	13.3	98 000	—	—	110 000	682	W682 ZZX	—	—	—	2.8	4.4	0.1	0.1
	5	2	2.5	0.1	0.08	0.210	0.05	0.001	13.3	98 000	—	—	110 000	ML2005	WML2005 ZZ	—	—	—	2.6	4.2	0.07	0.1
	6	2.3	3	0.15	0.1	0.410	0.10	0.003	11.4	86 000	—	—	100 000	692	W692 ZZ	—	—	—	3.2	4.8	0.1	0.2
	6	2.5	3	0.1	0.1	0.410	0.10	0.003	11.4	86 000	—	—	100 000	ML2006	WML2006 ZZX	—	—	—	2.8	5.2	0.1	0.3
	7	2.5	3	0.15	0.15	0.480	0.13	0.003	12.6	67 000	—	—	79 000	ML2007	WML2007 ZZX	—	—	—	3.2	5.8	0.15	0.4
	7	2.8	3.5	0.15	0.15	0.480	0.13	0.003	12.6	67 000	—	—	79 000	602	W602 ZZX	—	—	—	3.2	5.8	0.15	0.5
2.5	6	1.8	2.6	0.1	0.1	0.240	0.06	0.002	14.3	75 000	—	—	89 000	68/2.5	W68/2.5 ZZ	—	—	—	3.3	5.2	0.1	0.2
	7	2.5	3.5	0.15	0.15	0.390	0.11	0.003	13.7	66 000	—	—	79 000	69/2.5	W69/2.5 ZZ	—	—	—	3.7	5.8	0.15	0.4
	8	2.5	—	0.1	—	0.540	0.15	0.004	13.4	63 000	—	—	75 000	ML2508/1B	—	—	—	3.3	7.2	0.1	0.6	
	8	2.8	4	0.15	0.1	0.680	0.17	0.005	11.5	64 000	—	—	76 000	ML2508	WML2508 ZZX	—	—	—	3.7	6.8	0.1	0.6
3	6	2	2.5	0.08	0.05	0.240	0.06	0.002	14.3	75 000	—	—	89 000	ML3006	WML3006 ZZ	—	—	—	3.6	5.4	0.05	0.2
	7	2	3	(0.15)	(0.15)	0.390	0.11	0.003	13.7	66 000	—	—	79 000	683	W683 ZZ	—	—	—	4.2	5.8	0.1	0.3
	8	2.5	—	0.1	—	0.490	0.14	0.004	13.4	63 000	—	—	75 000	ML3008	—	—	—	3.8	7.2	0.1	0.5	
	8	3	4	0.15	0.15	0.680	0.17	0.005	11.5	64 000	—	—	76 000	693	W693 ZZ	—	—	—	4.2	6.8	0.15	0.6
	9	3	5	0.15	0.15	0.540	0.16	0.004	14.0	60 000	—	—	72 000	603	W603 ZZX	—	—	—	4.2	7.8	0.15	0.9
	10	4	4	0.15	0.15	0.800	0.22	0.006	12.8	52 000	—	44 000	63 000	623	623 ZZ	—	—	623 2RS	4.2	8.8	0.15	1.6
	13	5	5	0.2	0.2	1.65	0.49	0.01	12.3	44 000	—	—	54 000	633	633 ZZ	—	—	—	4.6	11.4	0.2	3.0
4	7	2	2.5	0.08	0.05	0.320	0.11	0.003	15.1	64 000	—	—	76 000	ML4007	WML4007 ZZ	—	—	—	4.6	6.4	0.05	0.2
	8	2	3	0.1	0.08	0.490	0.14	0.004	14.6	61 000	—	—	73 000	ML4008	WML4008 ZZ	—	—	—	4.8	7.2	0.08	0.4
	9	2.5	4	(0.15)	(0.15)	0.800	0.23	0.006	12.8	59 000	—	—	70 000	684	W684 ZZ	—	—	—	5.2	7.8	0.1	0.6

[Note] 1) Numerical values in () do not conform to JIS B 1521.

Extra-small ball bearings, miniature ball bearings

d (4) ~ (7) mm

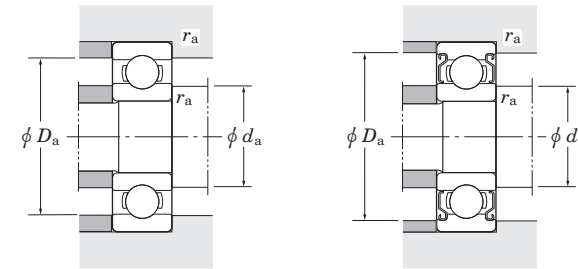
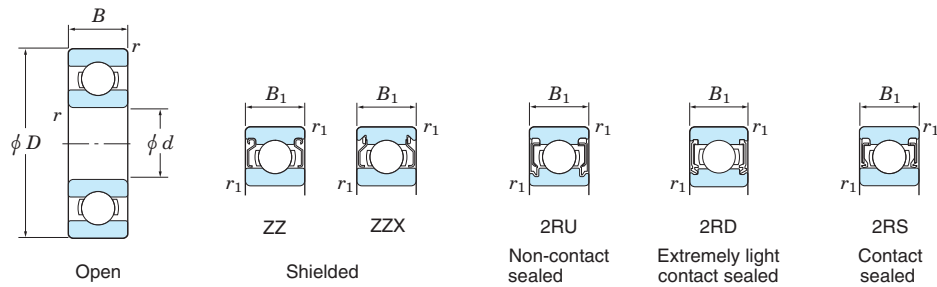

Boundary dimensions (mm)					Basic load ratings (kN)		Fatigue load limit (kN) C _u	Factor f ₀	Limiting speeds (min ⁻¹)				Bearing No.					Mounting dimensions (mm)			(Refer.) Mass (g)	
d	D	B	B ₁	r _{min.}	r _{1 min.}	C _r			C _{0r}	Grease lub.		Oil lub.		Open	Shielded	Non-contact sealed	Extremely light shielded	Contact sealed	d _{a min.}	D _{a max.}		r _{a max.}
								[Open ZZ, 2RU]	(2RD)	(2RS)	[Open Z]											
4	10	3	4	0.15	0.1	0.810	0.23	0.006	13.3	56 000	—	—	67 000	ML4010	WML4010 ZZ	—	—	—	5.2	8.8	0.1	1.0
	11	4	4	0.15	0.15	1.20	0.35	0.009	12.4	54 000	—	44 000	65 000	694	694 ZZ	694 2RU	—	694 2RS	5.2	9.8	0.15	1.8
	12	4	4	0.2	0.2	1.20	0.35	0.009	12.4	53 000	—	—	63 000	604	604 ZZ	—	—	—	5.6	10.4	0.2	2.1
	13	5	5	0.2	0.2	1.65	0.48	0.010	12.3	44 000	—	39 000	54 000	624	624 ZZ	624 2RU	—	624 2RS	5.6	11.4	0.2	2.9
	16	5	5	0.3	0.3	1.70	0.52	0.010	12.4	40 000	—	—	49 000	634	634 ZZ	—	—	—	6	14	0.3	5.3
5	8	2	2.5	0.08	0.05	0.270	0.09	0.002	15.7	59 000	—	—	70 000	ML5008	WML5008 ZZ	—	—	—	5.6	7.4	0.05	0.3
	9	2.5	3	0.1	0.08	0.540	0.17	0.004	15.3	56 000	—	—	67 000	ML5009	WML5009 ZZ	—	—	—	5.8	8.2	0.08	0.5
	10	3	4	0.1	0.1	0.540	0.17	0.005	14.8	55 000	—	—	65 000	ML5010	WML5010 ZZ	—	—	—	5.8	9	0.1	0.9
	11	3	5	0.15	0.15	0.890	0.28	0.007	12.8	53 000	—	—	63 000	685	W685 ZZ	—	—	—	6.2	9.8	0.15	1.0
	13	4	4	0.2	0.2	1.35	0.43	0.010	12.3	50 000	45 000	42 000	60 000	695	695 ZZ	695 2RU	695 2RD	695 2RS	6.6	11.4	0.2	2.2
	14	5	5	0.2	0.2	1.65	0.49	0.010	12.3	50 000	—	—	60 000	605	605 ZZ	—	—	—	6.6	12.4	0.2	3.5
	16	5	5	0.3	0.3	2.15	0.67	0.030	12.4	40 000	36 000	33 000	49 000	625	625 ZZ	625 2RU	—	625 2RS	7	14	0.3	5.0
	19	6	6	0.3	0.3	2.90	0.89	0.040	12.3	35 000	32 000	27 000	43 000	635	635 ZZ	635 2RU	—	635 2RS	7	17	0.3	8.5
6	10	2.5	3	0.1	0.08	0.620	0.22	0.006	15.7	53 000	—	—	63 000	ML6010	WML6010 ZZ	—	—	—	6.8	9.2	0.08	0.6
	12	3	4	0.15	0.1	0.890	0.29	0.008	14.5	49 000	—	37 000	59 000	ML6012	WML6012 ZZ	—	—	WML6012 2RS	7.2	10.8	0.1	1.3
	13	3.5	5	0.15	0.15	1.35	0.44	0.010	13.7	48 000	43 000	36 000	57 000	686	W686 ZZ	—	—	W686 2RS	7.2	11.8	0.15	1.8
	15	5	5	0.2	0.2	1.70	0.52	0.010	12.4	45 000	41 000	32 000	54 000	696	696 ZZ	696 2RU	696 2RD	696 2RS	7.6	13.4	0.2	3.9
	17	6	6	0.3	0.3	2.45	0.74	0.030	12.2	43 000	39 000	—	51 000	606	606 ZZ	606 2RU	606 2RD	—	8	15	0.3	5.8
	19	6	6	0.3	0.3	2.90	0.89	0.040	12.3	35 000	32 000	27 000	43 000	626	626 ZZ	626 2RU	626 2RD	626 2RS	8	17	0.3	8.1
	19	8	8	0.3	0.3	3.25	1.05	0.04	12.3	40 000	—	—	47 000	ML6019	ML6019 ZZ	—	—	—	7	18	0.3	9.0
	22	7	7	0.3	0.3	4.10	1.35	0.060	12.4	31 000	—	23 000	37 000	636	636 ZZ	—	—	636 2RS	8	20	0.3	13
7	11	2.5	3	0.1	0.08	0.540	0.23	0.006	16.1	49 000	—	—	59 000	ML7011	WML7011 ZZ	—	—	—	7.8	10.2	0.08	0.7
	13	3	4	0.15	0.15	0.680	0.28	0.007	14.9	47 000	—	—	55 000	ML7013	WML7013 ZZ	—	—	—	8.2	11.8	0.15	1.4
	14	3.5	5	0.15	0.15	1.45	0.51	0.010	14.2	45 000	—	—	54 000	687	W687 ZZ	—	—	—	8.2	12.8	0.15	2.0
	17	5	5	0.3	0.3	2.00	0.71	0.02	14.0	42 000	—	28 000	50 000	697	697 ZZ	—	—	697 2RS	9	15	0.3	5.3
	19	6	6	0.3	0.3	2.95	0.89	0.040	12.3	40 000	36 000	27 000	47 000	607	607 ZZ	607 2RU	607 2RD	607 2RS	9	17	0.3	7.6
	22	7	7	0.3	0.3	4.10	1.35	0.060	12.4	31 000	28 000	23 000	37 000	627	627 ZZ	627 2RU	627 2RD	627 2RS	9	20	0.3	13
	22	8	8	0.3	0.3	4.10	1.35	0.06	12.4	34 000	—	—	41 000	ML7022	ML7022 ZZ	—	—	—	9	20	0.3	14

Extra-small ball bearings, miniature ball bearings

d (7) ~ 9 mm

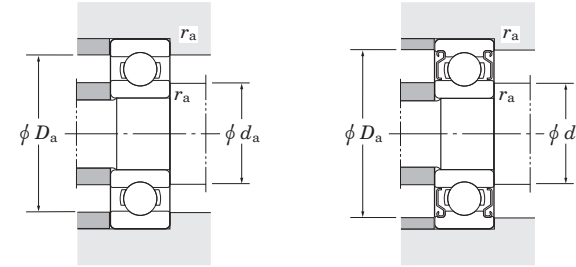
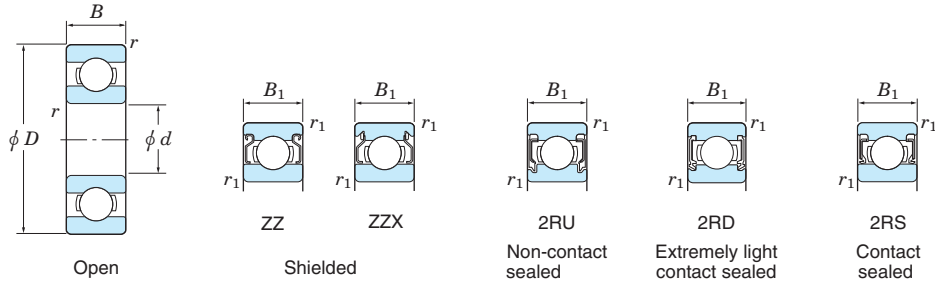

d	Boundary dimensions (mm)					Basic load ratings (kN)		Fatigue load limit (kN) C _u	Factor f ₀	Limiting speeds (min ⁻¹)				Bearing No.					Mounting dimensions (mm)			(Refer.) Mass (g)
	D	B	B ₁	r ⁽¹⁾ _{min.}	r ⁽¹⁾ _{min.}	C _r	C _{0r}			Grease lub.	(Open ZZ, 2RU)	(2RD)	(2RS)	Oil lub. (Open Z)	Open	Shielded	Non-contact sealed	Extremely light shielded	Contact sealed	d _a min.	D _a max.	
7	26	9	9	0.3	0.3	5.65	1.95	0.100	12.3	26 000	—	—	32 000	637	637 ZZ	—	—	—	9	24	0.3	24
8	12	2.5	3.5	0.1	0.08	0.680	0.27	0.007	16.4	47 000	—	—	55 000	ML8012	WML8012 ZZ	—	—	—	8.8	11.2	0.08	0.8
	14	3.5	4	0.15	0.15	1.00	0.39	0.010	15.3	44 000	—	—	52 000	ML8014	WML8014 ZZ	—	—	—	9.2	12.8	0.15	1.8
	16	4	5	0.2	0.2	1.55	0.59	0.020	14.0	42 000	38 000	28 000	50 000	688	W688 ZZ	W688 2RU	W688 2RD	W688 2RS	9.6	14.4	0.2	3.2
	19	6	6	0.3	0.3	2.80	0.91	0.040	12.9	39 000	35 000	27 000	46 000	698	698 ZZ	—	698 2RD	698 2RS	10	17	0.3	7.2
	22	7	7	0.3	0.3	4.10	1.35	0.060	12.4	34 000	31 000	23 000	41 000	608	608 ZZ	608 2RU	608 2RD	608 2RS	10	20	0.3	12
	24	8	8	0.3	0.3	4.15	1.40	0.060	12.8	28 000	—	22 000	35 000	628	628 ZZ	628 2RU	—	628 2RS	10	22	0.3	18
9	28	9	9	0.3	0.3	5.65	1.95	0.100	12.3	26 000	23 000	—	32 000	638	638 ZZ	—	638 2RD	—	10	26	0.3	29
	17	4	5	0.2	0.2	1.65	0.66	0.020	14.9	39 000	35 000	—	46 000	689	W689 ZZ	W689 2RU	W689 2RD	—	10.6	15.4	0.2	3.5
	20	6	6	0.3	0.3	3.10	1.05	0.040	13.3	35 000	32 000	25 000	42 000	699	699 ZZ	—	699 2RD	699 2RS	11	18	0.3	7.5
	24	7	7	0.3	0.3	4.15	1.40	0.060	12.8	33 000	30 000	22 000	40 000	609	609 ZZ	609 2RU	609 2RD	609 2RS	11	22	0.3	15
	26	8	8	(0.6)	(0.6)	5.70	1.95	0.100	12.4	27 000	24 000	19 000	33 000	629	629 ZZ	629 2RU	629 2RD	629 2RS	12.1	22	0.3	20
30	10	10	0.6	0.6	7.50	2.65	0.210	12.3	24 000	—	—	29 000	639	639 ZZ	—	—	—	13	26	0.6	35	

[Note] 1) Numerical values in () do not conform to JIS B 1521.

Extra-small ball bearings, miniature ball bearings
flanged type

d 1 ~ (4) mm

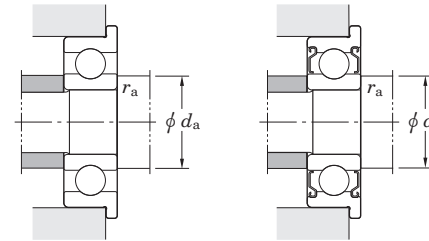
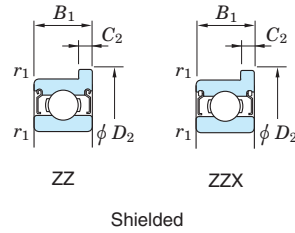
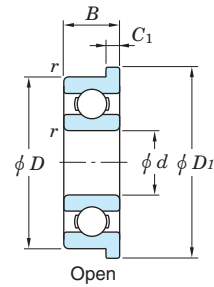

d	Boundary dimensions (mm)					Basic load ratings (kN)		Fatigue load limit	Factor	Limiting speeds (min^{-1})		Bearing No.	Dimensions of flange (mm)				Mounting dimensions (mm)		(Refer.) Mass (g)	
	D	B	B_1	$r_1^{(1)}$ min.	$r_1^{(1)}$ min.	C_r	C_{0r}	(kN) C_u	f_0	Grease lub.	Oil lub.		Open	Shielded	D_1	D_2	C_1	C_2		d_a min.
1	3	1	—	0.07	—	0.120	0.03	0.0007	11.6	130 000	150 000	F681	—	3.8	—	0.3	—	1.6	0.05	0.03
	4	1.6	—	0.1	—	0.170	0.04	0.001	11.4	120 000	140 000	F691	—	5	—	0.5	—	1.8	0.1	0.1
1.5	4	1.2	2	0.1	0.1	0.140	0.03	0.0009	13.2	120 000	140 000	F68/1.5	WF68/1.5 ZZ	5	5	0.4	0.6	2.3	0.1	0.1
	5	2	2.6	0.15	0.15	0.300	0.07	0.002	12.9	110 000	120 000	F69/1.5	WF69/1.5 ZZ	6.5	6.5	0.6	0.8	2.7	0.15	0.2
	6	2.5	3	0.1	0.1	0.410	0.10	0.003	11.4	86 000	100 000	MLF1506	WMLF1506 ZZ	7.5	7.5	0.6	0.8	2.3	0.1	0.4
2	5	1.5	2.3	0.1	0.1	0.210	0.05	0.001	13.3	99 000	120 000	F682	WF682 ZZ	6.1	6.1	0.5	0.6	2.8	0.1	0.1
	5	2	2.5	0.1	0.08	0.210	0.05	0.001	12.9	99 000	120 000	MLF2005	WMLF2005 ZZ	6.2	6.2	0.6	0.6	2.8	0.07	0.2
	6	2.3	3	0.15	0.1	0.410	0.10	0.003	11.4	86 000	100 000	F692	WF692 ZZ	7.5	7.5	0.6	0.8	3.2	0.1	0.3
	6	2.5	3	0.1	0.1	0.410	0.10	0.003	11.4	86 000	100 000	MLF2006	WMLF2006 ZZ	7.2	7.2	0.6	0.6	2.8	0.1	0.4
	7	2.5	3	0.15	0.15	0.480	0.13	0.003	12.6	67 000	79 000	MLF2007	WMLF2007 ZZ	8.2	8.2	0.6	0.6	3.2	0.15	0.5
	7	2.8	3.5	0.15	0.15	0.480	0.13	0.003	12.6	67 000	79 000	F602	WF602 ZZ	8.5	8.5	0.7	0.9	3.2	0.15	0.6
2.5	6	1.8	2.6	0.1	0.1	0.260	0.07	0.002	14.3	69 000	82 000	F68/2.5	WF68/2.5 ZZ	7.1	7.1	0.5	0.8	3.3	0.1	0.2
	7	2.5	3.5	0.15	0.15	0.480	0.13	0.003	12.7	66 000	79 000	F69/2.5	WF69/2.5 ZZ	8.5	8.5	0.7	0.9	3.7	0.15	0.5
	8	2.5	—	0.1	—	0.680	0.17	0.005	11.7	63 000	75 000	MLF2508/1B	—	9.2	—	0.6	—	3.5	0.1	0.7
	8	2.8	4	0.15	0.1	0.680	0.17	0.005	11.5	63 000	75 000	MLF2508	WMLF2508 ZZ	9.5	9.5	0.7	0.9	3.7	0.1	0.7
3	6	2	2.5	0.08	0.05	0.260	0.07	0.002	14.3	69 000	82 000	MLF3006	WMLF3006 ZZ	7.2	7.2	0.6	0.6	3.6	0.05	0.2
	7	2	3	(0.15)	(0.15)	0.390	0.11	0.003	14.0	65 000	78 000	F683	WF683 ZZ	8.1	8.1	0.5	0.8	4.2	0.1	0.4
	8	2.5	—	0.1	—	0.490	0.14	0.004	13.4	61 000	72 000	MLF3008	—	9.2	—	0.6	—	4.0	0.1	0.6
	8	3	4	0.15	0.15	0.690	0.18	0.005	11.9	63 000	75 000	F693	WF693 ZZ	9.5	9.5	0.7	0.9	4.2	0.15	0.7
	9	3	5	0.15	0.15	0.710	0.19	0.005	12.4	60 000	72 000	F603	WF603 ZZ	10.5	10.5	0.7	1	4.2	0.15	1.0
	10	4	4	0.15	0.15	0.800	0.22	0.006	12.4	61 000	72 000	F623	F623 ZZ	11.5	11.5	1	1	4.2	0.15	1.8
4	7	2	2.5	0.08	0.05	0.320	0.11	0.003	15.1	63 000	75 000	MLF4007	WMLF4007 ZZ	8.2	8.2	0.6	0.6	4.6	0.05	0.3
	8	2	3	0.1	0.08	0.490	0.14	0.004	13.9	61 000	72 000	MLF4008	WMLF4008 ZZ	9.2	9.2	0.6	0.6	4.8	0.08	0.5
	9	2.5	4	(0.15)	(0.15)	0.800	0.23	0.006	12.8	59 000	70 000	F684	WF684 ZZ	10.3	10.3	0.6	1	5.2	0.1	0.7
	10	3	4	0.15	0.1	0.880	0.27	0.007	13.5	56 000	66 000	MLF4010	WMLF4010 ZZ	11.2	11.6	0.6	0.8	5.2	0.1	1.1
	11	4	4	0.15	0.15	1.20	0.35	0.009	12.4	54 000	65 000	F694	F694 ZZ	12.5	12.5	1	1	5.2	0.15	2.0
	12	4	4	0.2	0.2	1.20	0.35	0.009	12.4	54 000	65 000	F604	F604 ZZ	13.5	13.5	1	1	5.6	0.2	2.3

[Note] 1) Numerical values in () do not conform to JIS B 1521.

Extra-small ball bearings, miniature ball bearings
flanged type

d (4) ~ 8 mm

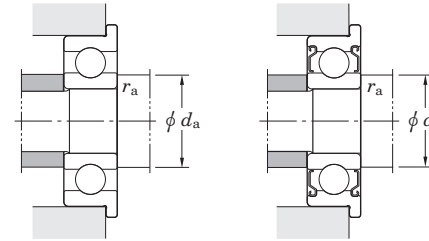
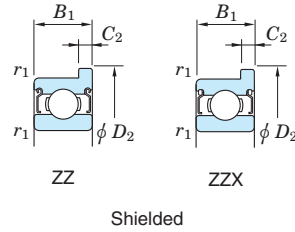
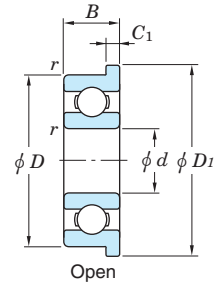

d	Boundary dimensions (mm)					Basic load ratings (kN)		Fatigue load limit (kN) C_u	Factor f_0	Limiting speeds (min^{-1})		Bearing No.	Dimensions of flange (mm)				Mounting dimensions (mm)		(Refer.) Mass (g)	
	D	B	B_1	r_{min}	r_1	C_r	C_{0r}			Grease lub.	Oil lub.		D_1	D_2	C_1	C_2	d_a min.	r_a max.		
4	13	5	5	0.2	0.2	0.010	0.48	1.65	12.2	50 000	60 000	F624 F634	F624 ZZ F634 ZZ	15	15	1	1	5.6	0.2	3.3
	16	5	5	0.3	0.3	0.010	0.52	1.70	13.0	47 000	55 000			18	18	1	1	6	0.3	5.7
5	8	2	2.5	0.08	0.05	0.270	0.09	0.002	15.8	59 000	70 000	MLF5008 MLF5009 MLF5010	WMLF5008 ZZ WMLF5009 ZZ WMLF5010 ZZ	9.2	9.2	0.6	0.6	5.6	0.05	0.4
	9	2.5	3	0.1	0.08	0.540	0.17	0.004	14.6	57 000	67 000			10.2	10.2	0.6	0.6	5.8	0.08	0.6
	10	3	4	0.1	0.1	0.540	0.17	0.005	14.8	57 000	67 000			11.2	11.6	0.6	0.8	5.8	0.1	1.0
	11	3	5	0.15	0.15	0.890	0.28	0.007	14.0	53 000	63 000	F685 F695 F605	WF685 ZZ F695 ZZ F605 ZZ	12.5	12.5	0.8	1	6.2	0.15	1.1
	13	4	4	0.2	0.2	1.35	0.43	0.010	13.4	49 000	59 000			15	15	1	1	6.6	0.2	2.5
	14	5	5	0.2	0.2	1.65	0.51	0.01	12.3	48 000	57 000	F625 F635	F625 ZZ F635 ZZ	16	16	1	1	6.6	0.2	3.9
	16	5	5	0.3	0.3	2.15	0.67	0.03	12.4	45 000	54 000			18	18	1	1	7	0.3	5.4
19	6	6	0.3	0.3	2.90	0.89	0.04	12.3	40 000	47 000	22	22	1.5	1.5	7	0.3	9.7			
6	10	2.5	3	0.1	0.08	0.620	0.22	0.006	15.2	53 000	63 000	MLF6010 MLF6012	WMLF6010 ZZ WMLF6012 ZZ	11.2	11.2	0.6	0.6	6.8	0.08	0.7
	12	3	4	0.15	0.1	0.890	0.29	0.008	14.5	49 000	59 000			13.2	13.6	0.6	0.8	7.2	0.1	1.4
	13	3.5	5	0.15	0.15	1.35	0.44	0.010	13.7	48 000	57 000	F686 F696 F606 F626 F636	WF686 ZZ F696 ZZ F606 ZZ F626 ZZ F636 ZZ	15	15	1	1.1	7.2	0.15	2.1
	15	5	5	0.2	0.2	1.70	0.52	0.01	13.0	47 000	55 000			17	17	1.2	1.2	7.6	0.2	4.3
	17	6	6	0.3	0.3	2.85	0.84	0.03	11.4	43 000	52 000	F606 F626	F606 ZZ F626 ZZ	19	19	1.2	1.2	8	0.3	6.3
	19	6	6	0.3	0.3	2.90	0.89	0.04	12.3	40 000	47 000			22	22	1.5	1.5	8	0.3	9.2
	22	7	7	0.3	0.3	4.10	1.35	0.06	12.4	34 000	41 000	25	25	1.5	1.5	8	0.3	14		
7	11	2.5	3	0.1	0.08	0.570	0.20	0.005	15.6	49 000	59 000	MLF7011 MLF7013	WMLF7011 ZZ WMLF7013 ZZ	12.2	12.2	0.6	0.6	7.8	0.08	0.8
	13	3	4	0.15	0.15	0.680	0.28	0.007	16.0	46 000	55 000			14.2	14.6	0.6	0.8	8.2	0.15	1.5
	14	3.5	5	0.15	0.15	1.45	0.51	0.010	14.2	45 000	54 000	F687 F697 F607 F627	WF687 ZZ F697 ZZ F607 ZZ F627 ZZ	16	16	1	1.1	8.2	0.15	2.4
	17	5	5	0.3	0.3	2.00	0.71	0.02	14.0	42 000	50 000			19	19	1.2	1.2	9	0.3	5.8
	19	6	6	0.3	0.3	2.95	0.89	0.04	12.1	40 000	47 000	F607 F627	F607 ZZ F627 ZZ	22	22	1.5	1.5	9	0.3	8.7
	22	7	7	0.3	0.3	4.10	1.35	0.06	12.4	34 000	41 000			25	25	1.5	1.5	9	0.3	14
8	12	2.5	3.5	0.1	0.08	0.680	0.27	0.007	15.9	47 000	55 000	MLF8012 MLF8014	WMLF8012 ZZ WMLF8014 ZZ	13.2	13.6	0.6	0.8	8.8	0.08	0.9
	14	3.5	4	0.15	0.15	1.00	0.42	0.01	15.3	44 000	52 000			15.6	15.6	0.8	0.8	9.2	0.15	2.0
	16	4	5	0.2	0.2	1.55	0.59	0.020	14.8	42 000	50 000	F688 F698 F608	WF688 ZZ F698 ZZ F608 ZZ	18	18	1	1.1	9.6	0.2	3.6
	19	6	6	0.3	0.3	2.80	0.91	0.040	12.9	39 000	46 000			22	22	1.5	1.5	10	0.3	8.3
	22	7	7	0.3	0.3	4.10	1.35	0.060	12.4	34 000	41 000	25	25	1.5	1.5	10	0.3	13		

Extra-small ball bearings, miniature ball bearings
flanged type

d 9 mm

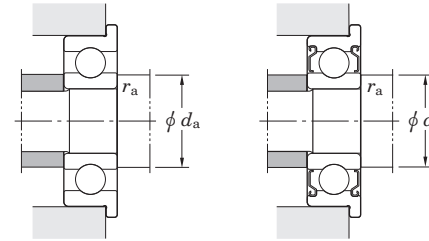
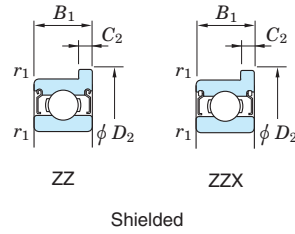
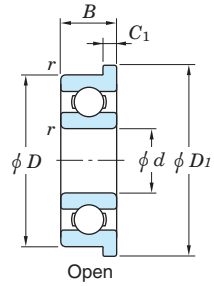

d	Boundary dimensions (mm)					Basic load ratings (kN)		Fatigue load limit (kN) C_u	Factor f_0	Limiting speeds (min^{-1})		Bearing No.		Dimensions of flange (mm)				Mounting dimensions (mm)		(Refer.) Mass (g)
	D	B	B_1	$r_{\text{min.}}$	$r_{1\text{min.}}$	C_r	C_{0r}			Grease lub.	Oil lub.	Open (ZZ, ZZX)	Open (Z, ZX)	Open	Shielded	D_1	D_2	C_1	C_2	
9	17	4	5	0.2	0.2	1.65	0.66	0.020	15.1	39 000	46 000	F689	WF689 ZZ	19	19	1	1.1	10.6	0.2	3.9
	20	6	6	0.3	0.3	3.10	1.05	0.04	13.3	37 000	44 000	F699	F699 ZZ	23	23	1.5	1.5	11	0.3	8.7
	24	7	7	0.3	0.3	4.15	1.45	0.06	12.8	32 000	38 000	F609	F609 ZZ	27	27	1.5	1.5	11	0.3	16

Double-row deep groove ball bearings

d 10 ~ (60) mm

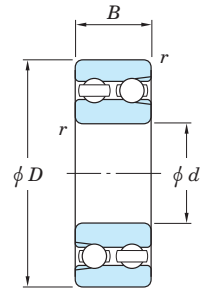

d (60) ~ 75 mm

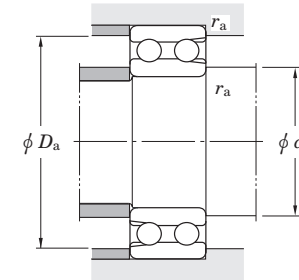

Boundary dimensions (mm)				Basic load ratings (kN)		Fatigue load limit (kN) C_u	Factor f_0	Limiting speeds (min^{-1})		Bearing No.	Mounting dimensions (mm)			(Refer.) Mass (kg)
d	D	B	$r_{\text{min.}}$	C_r	C_{0r}			Grease lub.	Oil lub.		d_a min.	D_a max.	r_a max.	
10	30	14	0.6	9.61	5.90	0.300	13.0	15 000	20 000	4200	14	26	0.6	0.057
12	32	14	0.6	9.71	6.15	0.320	13.6	14 000	18 000	4201	16	28	0.6	0.062
15	35	14	0.6	12.2	9.00	0.460	14.2	12 000	16 000	4202	19	31	0.6	0.071
	42	17	1	16.4	11.7	0.830	13.7	11 000	14 000	4302	20	37	1	0.123
17	40	16	0.6	14.6	10.4	0.710	14.1	11 000	14 000	4203	21	36	0.6	0.106
	47	19	1	20.6	15.0	1.05	13.7	9 400	13 000	4303	22	42	1	0.171
20	47	18	1	20.5	16.0	1.10	14.2	9 000	12 000	4204	25	42	1	0.165
	52	21	1.1	24.3	17.0	1.25	13.5	8 300	11 000	4304	26.5	45.5	1	0.227
25	52	18	1	20.4	16.9	1.05	15.0	7 500	9 900	4205	30	47	1	0.189
	62	24	1.1	32.9	25.7	1.75	14.1	6 700	9 000	4305	31.5	55.5	1	0.365
30	62	20	1	27.4	24.7	1.50	15.1	6 400	8 500	4206	35	57	1	0.298
	72	27	1.1	44.4	35.9	2.45	14.0	5 700	7 600	4306	36.5	65.5	1	0.542
35	72	23	1.1	33.0	30.7	1.85	15.2	5 600	7 400	4207	41.5	65.5	1	0.460
	80	31	1.5	50.7	41.8	2.85	14.1	5 200	7 000	4307	43	72	1.5	0.752
40	80	23	1.1	42.2	42.4	2.50	15.5	4 700	6 300	4208	46.5	73.5	1	0.558
	90	33	1.5	57.5	48.8	3.25	14.7	4 600	6 100	4308	48	82	1.5	1.01
45	85	23	1.1	39.8	43.9	2.45	15.8	4 600	6 100	4209	51.5	78.5	1	0.605
	100	36	1.5	72.0	62.4	4.20	14.3	4 100	5 500	4309	53	92	1.5	1.35
50	90	23	1.1	39.2	44.6	2.45	16.1	4 200	5 600	4210	56.5	83.5	1	0.651
	110	40	2	88.0	77.7	5.25	14.2	3 700	5 000	4310	59	101	2	1.80
55	100	25	1.5	46.5	54.1	2.95	16.1	3 800	5 000	4211	63	92	1.5	0.882
	120	43	2	105	94.4	6.40	14.2	3 400	4 600	4311	64	111	2	2.29
60	110	28	1.5	59.9	67.6	3.80	15.9	3 500	4 700	4212	68	102	1.5	1.20

Boundary dimensions (mm)				Basic load ratings (kN)		Fatigue load limit (kN) C_u	Factor f_0	Limiting speeds (min^{-1})		Bearing No.	Mounting dimensions (mm)			(Refer.) Mass (kg)
d	D	B	$r_{\text{min.}}$	C_r	C_{0r}			Grease lub.	Oil lub.		d_a min.	D_a max.	r_a max.	
60	130	46	2.1	124	113	7.70	14.1	3 100	4 200	4312	71	119	2	2.87
65	120	31	1.5	68.3	78.5	4.35	15.9	3 200	4 300	4213	73	112	1.5	1.59
	140	48	2.1	134	124	8.20	14.3	2 900	3 900	4313	76	129	2	3.46
70	125	31	1.5	77.7	89.8	5.05	15.8	3 100	4 100	4214	78	117	1.5	1.68
	150	51	2.1	144	136	8.55	14.4	2 700	3 600	4314	81	139	2	4.21
75	130	31	1.5	77.0	90.7	4.95	16.0	2 900	3 900	4215	83	122	1.5	1.77
	160	55	2.1	166	158	9.70	14.4	2 500	3 400	4315	86	149	2	5.15

Angular contact ball bearings

Angular contact ball bearings are suitable for applications which require high accuracy and good high-speed performance. This type of bearing is designed to carry a combined load.

- Single-row angular contact ball bearings and matched pair angular contact ball bearings

- The standard contact angles are 15°, 30° and 40°. They are identified, respectively, by the supplementary codes "C", "A" (omitted) and "B". Bearings with a smaller contact angle are more suitable for applications involving high-speed rotation. Those with a larger contact angle feature superior axial load resistance.

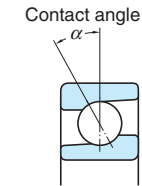

- Angular contact ball bearings are often preloaded to enhance their rigidity and rotating performance. (refer to p. A 112.)

For high-precision matched pair angular contact ball bearings of class 5 or higher, which are used in machine tools and other precision equipment, the standard preload is specified in three levels: slight (S), light (L), medium (M) and heavy (H). (refer to Table 11-2 on p. A 114.)

- When this type of bearing is loaded radially, an axial component of force is produced. In this case, two bearings are used together facing one another, or two or more bearings are matched and used. (refer to p. A 38.)
- Tables 1 and 2 list the different types of single-row and matched pair/stack angular contact ball bearings and describe their characteristics.

- Double-row angular contact ball bearings
Consist of two single-row angular contact ball bearings matched back-to-back, with inner and outer rings integrated.
Table 3 shows major types and their characteristics.

- Four-point contact ball bearings
 - Have a contact angle of 35° and an inner ring divided into two annular pieces. They are suitable for applications that involve either axial loading or combined loading, where the axial load makes up the major part of the load.
 - Able to support both axial load and a certain degree of radial load. Each rolling element is in contact with each of the inner and outer rings at a single point, and both contact points lie on the contact angle line. The line runs to either the right or left depending on the direction of the axial load.

Single-row angular contact ball bearings



Bore diameter 10 – 380 mm

Matched pair angular contact ball bearings

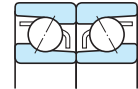

Bore diameter 10 – 380 mm

Double-row angular contact ball bearings

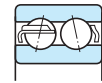

Bore diameter 10 – 110 mm

Four-point contact ball bearings



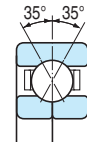

Bore diameter 20 – 110 mm



- Consult with JTEKT when using the four-point contact ball bearing because application conditions such as load magnitude should be examined carefully.



Table 1 Single-row angular contact ball bearings

<p>Standard type</p>  <p>(with pressed cage)</p>  <p>(with machined cage)</p>	<ul style="list-style-type: none"> Single-row angular contact ball bearings accommodate radial load and axial load in one direction. Bearings with a machined cage are suitable for high-speed applications.
---	--

Reference G-type bearing

"G-type" bearings have a stand-out between the inner ring and outer ring on both sides that are equal in size. This arrangement is called "flush ground processing." These bearings can be matched in a variety of ways.

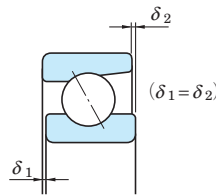
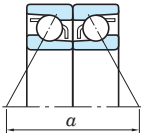
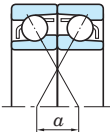
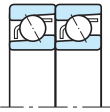

Table 2 Matched pair and stack angular contact ball bearings

<p>Back-to-back arrangement (DB)</p> 	<ul style="list-style-type: none"> Carries radial load and axial load in both directions. Suitable for applications involving moment loading because the distance between the load centers (α) is long. As for the preloaded type, the clearance is pre-adjusted so that bearings will be preloaded the proper amount when the inner ring is fixed with a nut.
<p>Face-to-face arrangement (DF)</p> 	<ul style="list-style-type: none"> Carries radial load and axial load in both directions. Has a smaller moment load accommodating capacity than the back-to-back arrangement, because the distance between the load centers (α) is shorter. As for the preloaded type, the clearance is pre-adjusted so that bearings will be preloaded the proper amount when the outer rings are pressed together.
<p>Tandem arrangement (DT)</p> 	<ul style="list-style-type: none"> Carries radial load and axial load in one direction. Suitable for applications which involve a high degree of axial loading.

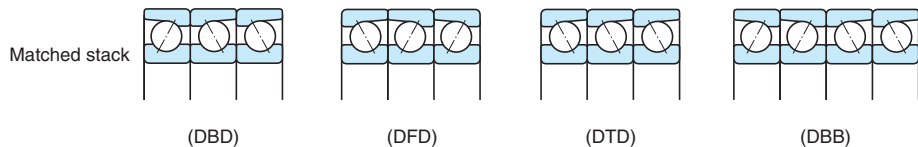
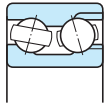
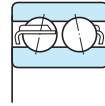
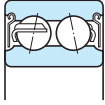
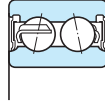

Table 3 Double-row angular contact ball bearings

 <p>(with filling slot) 32, 33</p>  <p>(without filling slot) 52, 53</p>  <p>Shielded 52...ZZ, 53...ZZ</p>  <p>Sealed 52...2RS, 53...2RS</p>	<ul style="list-style-type: none"> Accommodates radial load and axial load in both directions. Also able to accommodate moment load. When installing bearings with filling slot (32 and 33 series), the raceway side without filling slot must accommodate main load. The 32 and 33 series are provided with a filling slot, while the 52 and 53 series are not. 32 and 33 series : contact angle 32° 52 and 53 series : contact angle 24° Inferior to single-row and matched pair angular contact ball bearings in terms of high-speed and high accuracy performance. Shielded or sealed 52 and 53 series bearings are also available.
--	--

<p>Boundary dimensions</p>	The dimensions of standard series are as specified in JIS B 1512.					
<p>Tolerances</p>	<p>· As specified in JIS B 1514-1. (refer to Table 7-3 on pp. A 60 – A 63.)</p> <p>· JTEKT has established "special tolerances" for bore diameter and outside diameter, as listed in the table to the right, to make it easy to produce high-precision matched stack bearings. Bearings which are produced based on these tolerances are identified by the supplementary code "K5."</p>					
<p>Special tolerances (K5) Unit : μm</p>						
<p>Nominal bore diameter d (mm)</p>		<p>Single plane mean bore diameter (Δd_{mp}) or single plane mean outside diameter deviation (ΔD_{mp})</p>				
		<p>class 5</p>		<p>class 4</p>		
over	up to	upper	lower	upper	lower	
–	50	– 1	– 4	– 1	– 3	
50	80	– 1	– 5	– 1	– 4	
80	120	– 1	– 5	– 1	– 4	
<p>Internal clearance</p>	<ul style="list-style-type: none"> Matched pair bearing axial internal clearance.....(refer to Table 10-4 on p. A 103.) Double-row bearing radial internal clearance.....(refer to Table 10-5 on p. A 104.) 					
<p>Recommended fits</p>	<ul style="list-style-type: none"> Classes 0 and 6 bearings.....(refer to Table 9-4 on pp. A 91, 92.) Classes 5 and 4 bearings.....as listed in the table below. 					
<p>Fit</p>		<p>class 5</p>		<p>class 4</p>		
		<p>Tolerance class</p>				
<p>With shaft</p>	Inner ring rotation	js 5	js 4			
	Outer ring rotation	h 5	h 4			
<p>With housing</p>	Fixed side	JS 6	JS 5			
	Free side	H 6	H 5			
	Outer ring rotation	M 5	M 4			
<ul style="list-style-type: none"> Refer to Table 11-3 on page A 115 for the recommended fits of high-precision matched pair bearings (class 5 and class 4), which are used with light preload (L) or middle preload (M). 						

Standard cages	<ul style="list-style-type: none"> Pressed cage (supplementary code : //) Copper alloy machined cage (supplementary code : FY) 	Application of standard cages		
		Bearing series	Pressed cage	Machined cage
	<p>[Note] Machine tools are generally equipped with bearings that have a phenolic resin machined cage (FT). Bearings with a polyamide molded cage can also be used depending on the applications. Four-point contact ball bearings usually use a copper alloy machined cage.</p>	79C	—	7900C – 7932C
		79CPA	—	7900CPA – 7932CPA
		70	—	7000 – 7040
		70B	—	7000B – 7040B
		70C	—	7000C – 7040C
		70CPA	—	7000CPA – 7034CPA
		72	7200 – 7220	7200 – 7240
		72B	7200B – 7220B	7200B – 7240B
		72C	7200C – 7220C	7200C – 7240C
		72CPA	—	7200CPA – 7230CPA
		73	7300 – 7320	7300 – 7340
		73B	7303B – 7320B	7303B – 7340B
		73C	7303C – 7320C	7303C – 7334C
		74	7405 – 7409	7404 – 7418
		74B	7405B – 7409B	7404B – 7418B
	32	3200 – 3215	3216 – 3222	
	33	3302 – 3313	3314 – 3322	
	52	5203 – 5214	—	
	53	5304 – 5315	—	

Allowable misalignment Single-row.....0.000 6 rad (2') : Matched pair, double-row.....misalignment not allowed

Equivalent radial load	<p>Dynamic equivalent radial load</p> $P_r = XF_r + YF_a$	Contact angle	$i f_0 F_a^*$	C_{Or}	e	Single-row and tandem arrangement				Back-to-back and face-to-face arrangement			
						$F_a/F_r \leq e$		$F_a/F_r > e$		$F_a/F_r \leq e$		$F_a/F_r > e$	
						X	Y	X	Y	X	Y	X	Y
		15°	0.178	0.38				1.47		1.65		2.39	
			0.357	0.40				1.40		1.57		2.28	
			0.714	0.43				1.30		1.46		2.11	
			1.07	0.46				1.23		1.38		2.00	
			1.43	0.47	1	0	0.44	1.19	1	1.34	0.72	1.93	
			2.14	0.50				1.12		1.26		1.82	
			3.57	0.55				1.02		1.14		1.66	
		5.35	0.56				1.00		1.12		1.63		
		7.14	0.56				1.00		1.12		1.63		
		30°	—	0.80	1	0	0.39	0.76	1	0.78	0.63	1.24	
		40°	—	1.14	1	0	0.35	0.57	1	0.55	0.57	0.93	

[Note] When two single-row angular contact ball bearings are used facing one another, an axial component of force is produced under radial load. In this case, refer to page A 38 for calculation of the dynamic equivalent radial load.

* For i , use 2 for DB&DF and 1 for single&DT. Factor f_0 is shown in the bearing dimension table.

Static equivalent radial load	$P_{0r} = X_0 F_r + Y_0 F_a$	Contact angle	Single-row and tandem arrangement		Back-to-back and face-to-face arrangement	
			X_0	Y_0	X_0	Y_0
		15°	0.5	0.46	1	0.92
		30°	0.5	0.33	1	0.66
		40°	0.5	0.26	1	0.52

In reference to single-row and tandem arrangement bearings, when $P_{0r} < F_r$, $P_{0r} = F_r$

Equivalent radial load	<p>Dynamic equivalent radial load</p> $P_r = XF_r + YF_a$	Contact angle	e	$F_a/F_r \leq e$		$F_a/F_r > e$		(reference)
				X	Y	X	Y	
		24°	0.66	1	0.95	0.68	1.45	52, 53 series
		32°	0.86	1	0.73	0.62	1.17	32, 33 series

Static equivalent radial load	$P_{0r} = X_0 F_r + Y_0 F_a$	Contact angle	X_0	Y_0	(reference)
		24°	1	0.78	52, 53 series
		32°	1	0.63	32, 33 series

[Note] In angular contact ball bearings, slippage occurs between the balls and raceways under too small a load, causing smearing to develop. Matched pair bearings may develop smearing when the ratio of the axial load to the radial load exceeds the value of e ($F_a / F_r > e$), as listed in the specification table. Consult with JTEKT when these bearings are used under the above conditions.

[Reference] Relationship between axial load and axial displacement

Diagrams (1) to (9) illustrate the relationship between axial load and axial displacement.

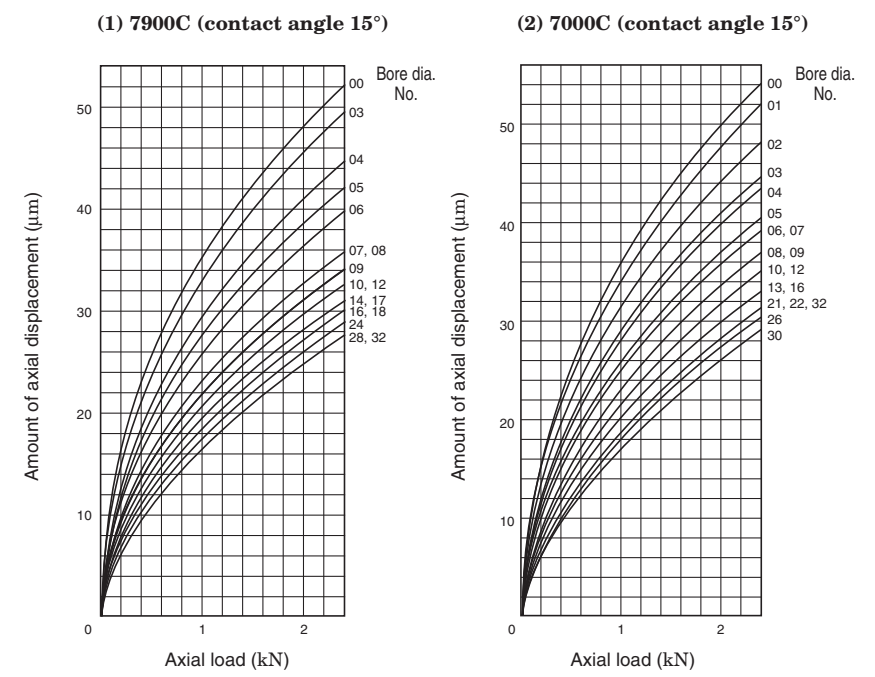

(3) 7200C (contact angle 15°)

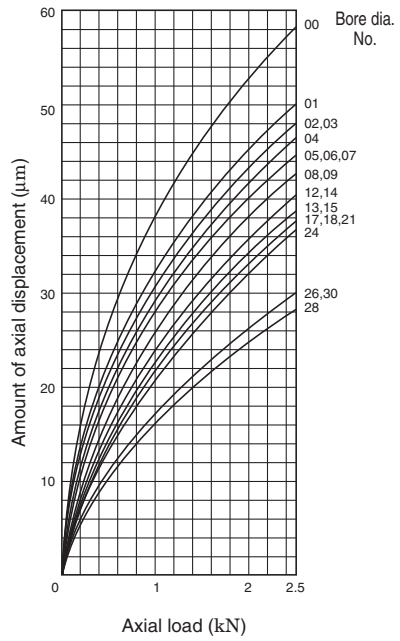

(6) 7000B (contact angle 40°)

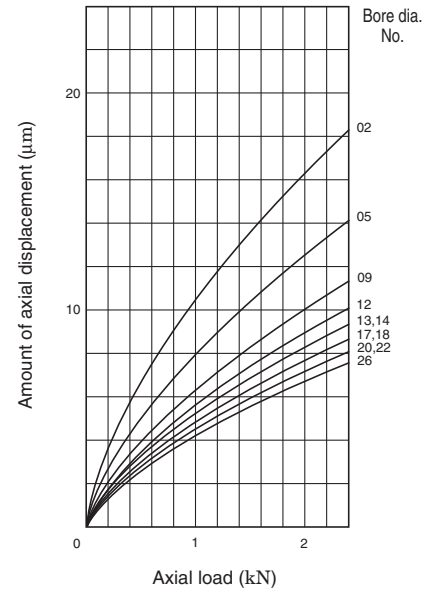

(7) 7200B (contact angle 40°)

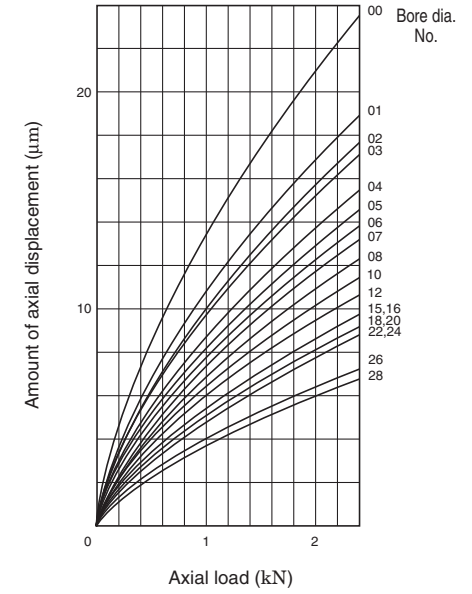

(4) 7000 (contact angle 30°)

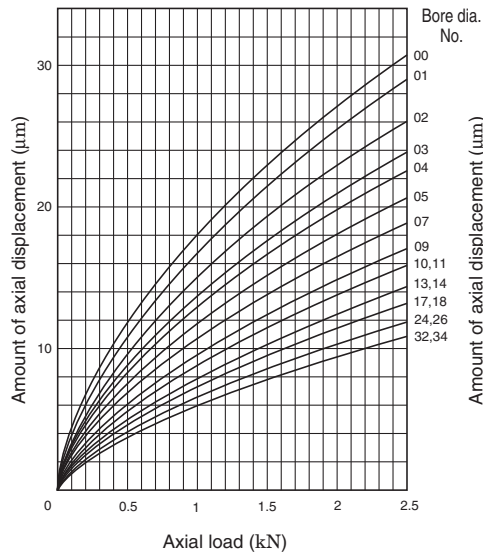

(5) 7200 (contact angle 30°)

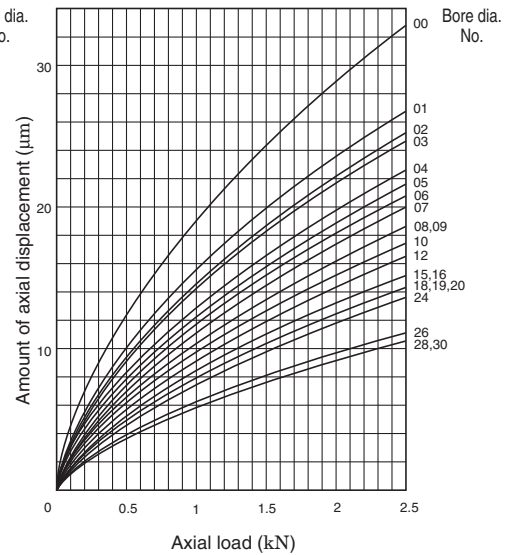

Single-row angular contact ball bearings

d 10 ~ (17) mm

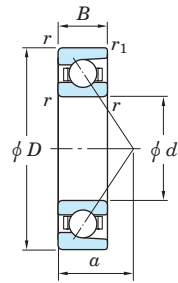

With machined cage

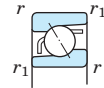

With pressed cage

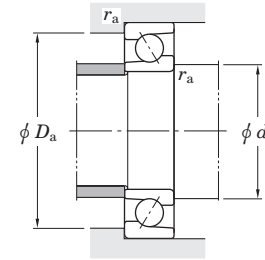

Boundary dimensions (mm)					Basic load ratings (kN)				Fatigue load limits (kN)		Factor	Limiting speeds ¹⁾ (min ⁻¹)		Bearing No. ²⁾	Load center (mm) a	Mounting dimensions (mm)			(Refer.) Mass (kg)
d	D	B	r min.	r1 min.	With machined cage		With pressed cage		C _u			Grease lub.	Oil lub.			d _a min.	D _a max.	r _a max.	
10	22	6	0.3	0.15	3.75	1.50	—	—	0.060	—	14.2	52 000	69 000	7900C	5.1	12.5	19.5	0.3	0.008
	26	8	0.3	0.15	6.25	2.35	—	—	0.120	—	—	34 000	42 000	7000	9.1	12.5	23.5	0.3	0.021
	26	8	0.3	0.15	5.80	2.15	—	—	0.110	—	—	25 000	33 000	7000B	11.6	12.5	23.5	0.3	0.021
	26	8	0.3	0.15	6.60	2.45	—	—	0.130	—	12.5	47 000	62 000	7000C	6.4	12.5	23.5	0.3	0.021
	30	9	0.6	0.3	5.85	2.20	6.75	2.75	0.110	0.140	—	29 000	37 000	7200	10.4	14.5	25.5	0.6	0.031
	30	9	0.6	0.3	5.35	2.00	6.20	2.50	0.100	0.130	—	22 000	29 000	7200B	13.1	14.5	25.5	0.6	0.031
	30	9	0.6	0.3	6.25	2.35	7.25	2.95	0.120	0.150	13.4	40 000	54 000	7200C	7.2	14.5	25.5	0.6	0.031
	35	11	0.6	0.3	10.6	3.75	11.6	4.30	0.300	0.340	—	27 000	33 000	7300	12.0	14.5	30.5	0.6	0.054
12	24	6	0.3	0.15	4.00	1.70	—	—	0.070	—	14.7	48 000	62 000	7901C	5.4	14.5	21.5	0.3	0.010
	28	8	0.3	0.15	6.75	2.75	—	—	0.140	—	—	29 000	37 000	7001	9.9	14.5	25.5	0.3	0.024
	28	8	0.3	0.15	6.20	2.50	—	—	0.130	—	—	22 000	29 000	7001B	12.6	14.5	25.5	0.3	0.024
	28	8	0.3	0.15	7.25	2.95	—	—	0.150	—	13.4	40 000	54 000	7001C	6.7	14.5	25.5	0.3	0.024
	32	10	0.6	0.3	9.30	3.65	10.0	4.05	0.280	0.310	—	27 000	34 000	7201	11.4	16.5	27.5	0.6	0.038
	32	10	0.6	0.3	8.65	3.40	9.30	3.75	0.240	0.270	—	20 000	27 000	7201B	14.2	16.5	27.5	0.6	0.038
	32	10	0.6	0.3	9.90	3.85	10.6	4.30	0.300	0.330	12.5	38 000	50 000	7201C	7.9	16.5	27.5	0.6	0.038
	37	12	1	0.6	12.8	4.60	14.0	5.25	0.360	0.410	—	24 000	31 000	7301	13.1	17.5	31.5	1	0.065
15	28	7	0.3	0.15	5.95	2.65	—	—	0.110	—	14.5	39 000	52 000	7902C	6.4	17.5	25.5	0.3	0.015
	32	9	0.3	0.15	7.65	3.45	—	—	0.180	—	—	26 000	32 000	7002	11.3	17.5	29.5	0.3	0.035
	32	9	0.3	0.15	6.95	3.15	—	—	0.160	—	—	19 000	25 000	7002B	14.6	17.5	29.5	0.3	0.035
	32	9	0.3	0.15	8.25	3.70	—	—	0.190	—	14.1	35 000	47 000	7002C	7.6	17.5	29.5	0.3	0.035
	35	11	0.6	0.3	10.1	4.25	10.1	4.25	0.300	0.300	—	24 000	29 000	7202	12.9	19.5	30.5	0.6	0.048
	35	11	0.6	0.3	9.30	3.95	9.30	3.95	0.260	0.260	—	18 000	24 000	7202B	16.2	19.5	30.5	0.6	0.048
	35	11	0.6	0.3	10.8	4.55	10.8	4.55	0.340	0.340	13.3	33 000	43 000	7202C	8.9	19.5	30.5	0.6	0.048
	42	13	1	0.6	15.7	6.45	16.8	7.20	0.490	0.550	—	20 000	25 000	7302	15.0	20.5	36.5	1	0.088
17	30	7	0.3	0.15	6.25	2.95	—	—	0.120	—	14.9	36 000	47 000	7903C	6.7	19.5	27.5	0.3	0.016
	35	10	0.3	0.15	8.40	4.15	—	—	0.210	—	—	23 000	28 000	7003	12.7	19.5	32.5	0.3	0.045

[Notes] 1) Limiting speeds shown above are applicable to machined cage bearings. Limiting speeds of pressed cage bearings should be kept to under 80% of this value. For bearings with 15° contact angle, this figure is applied to the high precision bearings ranked higher than class 5, used with machined cage or molded cage.

2) B, C or no indication after the bearing number indicates nominal contact angle of 40°, 15° and 30° respectively. [Remark] Standard cage types used for the above bearings are described earlier in this section.

Single-row angular contact ball bearings

d (17) ~ (25) mm

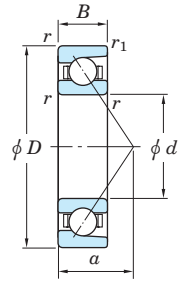

With machined cage

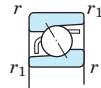

With pressed cage

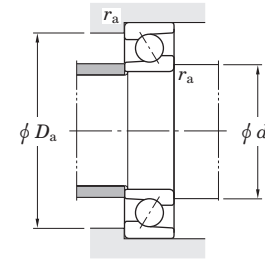

Boundary dimensions (mm)					Basic load ratings (kN)				Fatigue load limits (kN)		Factor	Limiting speeds ¹⁾ (min ⁻¹)		Bearing No. ²⁾	Load center (mm) a	Mounting dimensions (mm)			(Refer.) Mass (kg)
d	D	B	r min.	r1 min.	With machined cage		With pressed cage		Cu			Grease lub.	Oil lub.			da min.	Da max.	ra max.	
17	35	10	0.3	0.15	7.60	3.75	—	—	0.190	—	—	17 000	23 000	7003B	16.1	19.5	32.5	0.3	0.045
	35	10	0.3	0.15	9.15	4.45	—	—	0.230	—	14.6	31 000	41 000	7003C	8.6	19.5	32.5	0.3	0.045
	40	12	0.6	0.3	12.7	5.50	12.7	5.50	0.380	0.380	—	21 000	26 000	7203	14.4	21.5	35.5	0.6	0.070
	40	12	0.6	0.3	11.7	5.05	11.7	5.05	0.330	0.330	—	16 000	21 000	7203B	18.2	21.5	35.5	0.6	0.070
	40	12	0.6	0.3	13.6	5.90	13.6	5.90	0.440	0.440	13.4	29 000	38 000	7203C	9.9	21.5	35.5	0.6	0.070
	47	14	1	0.6	18.7	7.90	20.0	8.75	0.590	0.660	—	18 000	23 000	7303	16.5	22.5	41.5	1	0.120
	47	14	1	0.6	17.3	7.30	18.5	8.10	0.510	0.570	—	14 000	18 000	7303B	20.8	22.5	41.5	1	0.120
	47	14	1	0.6	19.8	8.40	19.8	8.40	0.650	0.650	12.6	25 000	33 000	7303C	11.4	22.5	41.5	1	0.120
20	37	9	0.3	0.15	9.10	4.55	—	—	0.240	—	14.9	30 000	39 000	7904C	8.3	22.5	34.5	0.3	0.035
	42	12	0.6	0.3	12.9	6.10	—	—	0.390	—	—	19 000	24 000	7004	15.1	24.5	37.5	0.6	0.079
	42	12	0.6	0.3	11.7	5.55	—	—	0.340	—	—	14 000	19 000	7004B	19.2	24.5	37.5	0.6	0.079
	42	12	0.6	0.3	13.9	6.60	—	—	0.450	—	14.1	26 000	35 000	7004C	10.2	24.5	37.5	0.6	0.079
	47	14	1	0.6	18.1	8.40	19.2	9.15	0.580	0.640	—	17 000	22 000	7204	17.0	25.5	41.5	1	0.112
	47	14	1	0.6	16.6	7.70	17.6	8.40	0.500	0.550	—	13 000	17 000	7204B	21.5	25.5	41.5	1	0.112
	47	14	1	0.6	19.4	9.00	20.6	9.80	0.670	0.730	13.4	24 000	32 000	7204C	11.6	25.5	41.5	1	0.112
	52	15	1.1	0.6	21.8	9.40	23.4	10.4	0.710	0.790	—	17 000	21 000	7304	17.9	27	45	1	0.150
	52	15	1.1	0.6	20.2	8.70	21.7	9.65	0.610	0.680	—	13 000	17 000	7304B	22.6	27	45	1	0.150
	52	15	1.1	0.6	23.1	9.95	24.8	11.1	0.780	0.860	12.6	23 000	31 000	7304C	12.3	27	45	1	0.150
	72	19	1.1	0.6	44.5	19.1	—	—	1.50	—	—	9 600	13 000	7404	23.1	27	65	1	0.395
	72	19	1.1	0.6	41.9	17.9	—	—	1.40	—	—	8 500	12 000	7404B	29.2	27	65	1	0.395
25	42	9	0.3	0.15	10.2	5.45	—	—	0.300	—	15.5	25 000	33 000	7905C	9.1	27.5	39.5	0.3	0.041
	47	12	0.6	0.3	14.1	7.40	—	—	0.450	—	—	17 000	21 000	7005	16.4	29.5	42.5	0.6	0.091
	47	12	0.6	0.3	12.8	6.70	—	—	0.390	—	—	12 000	17 000	7005B	21.1	29.5	42.5	0.6	0.091
	47	12	0.6	0.3	15.4	8.00	—	—	0.510	—	14.7	23 000	30 000	7005C	10.8	29.5	42.5	0.6	0.091
	52	15	1	0.6	19.2	9.50	20.2	10.3	0.620	0.670	—	15 000	19 000	7205	18.8	30.5	46.5	1	0.135
	52	15	1	0.6	17.5	8.70	18.4	9.40	0.530	0.580	—	12 000	15 000	7205B	23.9	30.5	46.5	1	0.135

[Notes] 1) Limiting speeds shown above are applicable to machined cage bearings. Limiting speeds of pressed cage bearings should be kept to under 80% of this value. For bearings with 15° contact angle, this figure is applied to the high precision bearings ranked higher than class 5, used with machined cage or molded cage.

2) B, C or no indication after the bearing number indicates nominal contact angle of 40°, 15° and 30° respectively.

[Remark] Standard cage types used for the above bearings are described earlier in this section.

Single-row angular contact ball bearings

d (25) ~ (35) mm

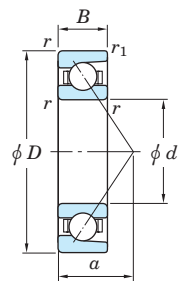

With machined cage

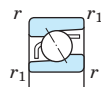

With pressed cage

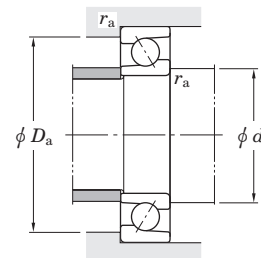

Boundary dimensions (mm)				Basic load ratings (kN)				Fatigue load limits (kN)		Factor	Limiting speeds ¹⁾ (min ⁻¹)		Bearing No. ²⁾	Load center (mm) a	Mounting dimensions (mm)			(Refer.) Mass (kg)	
d	D	B	r min.	r1 min.	Cr	C0r	Cr	C0r	Cr		C0r	Grease lub.			Oil lub.	da min.	Da max.		ra max.
25	52	15	1	0.6	20.7	10.2	21.9	11.1	0.710	0.770	14.0	21 000	28 000	7205C	12.7	30.5	46.5	1	0.135
	62	17	1.1	0.6	31.0	14.4	33.0	15.8	1.05	1.15	—	14 000	17 000	7305	21.1	32	55	1	0.243
	62	17	1.1	0.6	28.6	13.3	30.5	14.6	0.910	1.00	—	10 000	14 000	7305B	26.8	32	55	1	0.243
	62	17	1.1	0.6	33.0	15.3	35.1	16.8	1.20	1.30	12.8	19 000	25 000	7305C	14.3	32	55	1	0.243
	80	21	1.5	1	49.7	23.2	53.3	25.7	1.80	2.00	—	8 200	11 000	7405	26.4	33.5	71.5	1.5	0.527
	80	21	1.5	1	46.1	21.5	49.5	23.9	1.55	1.70	—	7 300	10 000	7405B	33.6	33.5	71.5	1.5	0.527
30	47	9	0.3	0.15	10.4	6.25	—	—	0.320	—	15.9	22 000	29 000	7906C	9.7	32.5	44.5	0.3	0.046
	55	13	1	0.6	18.2	10.1	—	—	0.610	—	—	14 000	18 000	7006	18.8	35.5	49.5	1	0.133
	55	13	1	0.6	16.4	9.20	—	—	0.530	—	—	11 000	14 000	7006B	24.3	35.5	49.5	1	0.133
	55	13	1	0.6	19.8	11.0	—	—	0.690	—	14.9	20 000	26 000	7006C	12.2	35.5	49.5	1	0.133
	62	16	1	0.6	26.7	13.7	28.1	14.8	0.890	0.970	—	13 000	16 000	7206	21.5	35.5	56.5	1	0.208
	62	16	1	0.6	24.3	12.5	25.6	13.6	0.770	0.840	—	9 600	13 000	7206B	27.6	35.5	56.5	1	0.208
	62	16	1	0.6	28.8	14.7	30.4	16.0	1.00	1.10	14.0	18 000	24 000	7206C	14.3	35.5	56.5	1	0.208
	72	19	1.1	0.6	37.6	18.9	39.9	20.6	1.30	1.45	—	12 000	14 000	7306	24.5	37	65	1	0.362
	72	19	1.1	0.6	34.5	17.4	36.6	19.0	1.15	1.25	—	8 700	12 000	7306B	31.3	37	65	1	0.362
	72	19	1.1	0.6	40.4	20.3	42.8	22.1	1.50	1.65	13.4	16 000	21 000	7306C	16.5	37	65	1	0.362
	90	23	1.5	1	59.5	28.4	63.9	31.6	2.20	2.45	—	7 300	9 700	7406	29.3	38.5	81.5	1.5	0.686
	90	23	1.5	1	55.2	26.4	59.3	29.3	1.90	2.10	—	6 500	8 900	7406B	37.3	38.5	81.5	1.5	0.686
35	55	10	0.6	0.3	15.7	9.70	—	—	0.550	—	15.7	19 000	25 000	7907C	11.0	39.5	50.5	0.6	0.074
	62	14	1	0.6	21.9	12.6	—	—	0.740	—	—	12 000	15 000	7007	21.2	40.5	56.5	1	0.170
	62	14	1	0.6	19.7	11.4	—	—	0.640	—	—	9 200	12 000	7007B	27.6	40.5	56.5	1	0.170
	62	14	1	0.6	23.9	13.7	—	—	0.840	—	15.0	17 000	22 000	7007C	13.5	40.5	56.5	1	0.170
	72	17	1.1	0.6	35.2	18.6	37.1	20.2	1.20	1.30	—	11 000	14 000	7207	24.2	42	65	1	0.295
	72	17	1.1	0.6	32.0	17.0	33.8	18.5	1.05	1.15	—	8 300	11 000	7207B	31.4	42	65	1	0.295
	72	17	1.1	0.6	38.0	20.1	40.1	21.7	1.40	1.50	14.0	15 000	20 000	7207C	15.8	42	65	1	0.295
	80	21	1.5	1	44.2	22.0	49.9	26.4	1.55	1.85	—	10 000	13 000	7307	27.4	43.5	71.5	1.5	0.475
	80	21	1.5	1	40.6	20.2	45.8	24.3	1.30	1.60	—	7 700	10 000	7307B	35.0	43.5	71.5	1.5	0.475

[Notes] 1) Limiting speeds shown above are applicable to machined cage bearings. Limiting speeds of pressed cage bearings should be kept to under 80% of this value. For bearings with 15° contact angle, this figure is applied to the high precision bearings ranked higher than class 5, used with machined cage or molded cage.

2) B, C or no indication after the bearing number indicates nominal contact angle of 40°, 15° and 30° respectively. [Remark] Standard cage types used for the above bearings are described earlier in this section.

Single-row angular contact ball bearings

d (35) ~ 45 mm

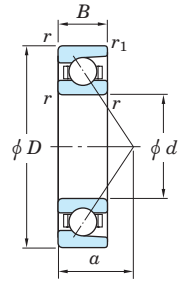

With machined cage

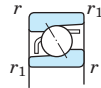

With pressed cage

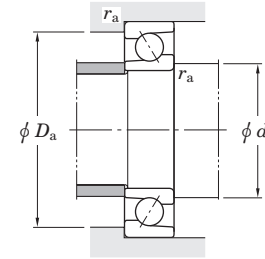

Boundary dimensions (mm)					Basic load ratings (kN)				Fatigue load limits (kN)		Factor	Limiting speeds ¹⁾ (min ⁻¹)		Bearing No. ²⁾	Load center (mm) a	Mounting dimensions (mm)			(Refer.) Mass (kg)
d	D	B	r min.	r1 min.	With machined cage		With pressed cage		Cu			Grease lub.	Oil lub.			da min.	Da max.	ra max.	
					Cr	C0r	Cr	C0r	[With machined cage]	[With pressed cage]	f0								
35	80	21	1.5	1	47.4	23.6	53.5	28.3	1.75	2.10	13.4	14 000	19 000	7307C	18.3	43.5	71.5	1.5	0.475
	100	25	1.5	1	75.6	37.0	81.1	41.1	2.85	3.20	—	6 500	8 600	7407	32.6	43.5	91.5	1.5	0.950
	100	25	1.5	1	70.2	34.3	75.3	38.1	2.45	2.75	—	5 700	7 900	7407B	41.7	43.5	91.5	1.5	0.950
40	62	12	0.6	0.3	19.7	12.4	—	—	0.710	—	15.7	17 000	22 000	7908C	12.8	44.5	57.5	0.6	0.107
	68	15	1	0.6	23.4	14.6	—	—	0.830	—	—	11 000	14 000	7008	23.2	45.5	62.5	1	0.210
	68	15	1	0.6	21.1	13.2	—	—	0.720	—	—	8 300	11 000	7008B	30.2	45.5	62.5	1	0.210
	68	15	1	0.6	25.7	15.9	—	—	0.940	—	15.4	15 000	20 000	7008C	14.8	45.5	62.5	1	0.210
	80	18	1.1	0.6	42.0	23.3	44.1	25.1	1.50	1.60	—	10 000	12 000	7208	26.3	47	73	1	0.382
	80	18	1.1	0.6	38.2	21.3	40.2	23.0	1.30	1.40	—	7 500	10 000	7208B	34.2	47	73	1	0.382
	80	18	1.1	0.6	45.4	25.2	47.7	27.1	1.70	1.85	14.2	14 000	18 000	7208C	17.0	47	73	1	0.382
	90	23	1.5	1	54.0	27.4	61.0	32.9	1.90	2.30	—	9 200	12 000	7308	30.3	48.5	81.5	1.5	0.657
	90	23	1.5	1	49.6	25.2	56.0	30.3	1.65	2.00	—	6 900	9 200	7308B	38.8	48.5	81.5	1.5	0.657
	90	23	1.5	1	57.9	29.4	65.4	35.3	2.20	2.65	13.4	13 000	17 000	7308C	20.2	48.5	81.5	1.5	0.657
	110	27	2	1	87.4	43.5	93.8	48.4	3.35	3.70	—	5 900	7 900	7408	35.5	50	100	2	1.23
	110	27	2	1	81.1	40.4	87.0	44.9	2.90	3.20	—	5 200	7 200	7408B	45.4	50	100	2	1.23
45	68	12	0.6	0.3	20.8	14.1	—	—	0.770	—	16.0	15 000	20 000	7909C	13.6	49.5	63.5	0.6	0.127
	75	16	1	0.6	27.8	17.7	—	—	1.00	—	—	10 000	12 000	7009	25.3	50.5	69.5	1	0.260
	75	16	1	0.6	25.0	16.0	—	—	0.870	—	—	7 500	10 000	7009B	33.2	50.5	69.5	1	0.260
	75	16	1	0.6	30.5	19.3	—	—	1.15	—	15.4	14 000	18 000	7009C	16.0	50.5	69.5	1	0.260
	85	19	1.1	0.6	47.2	26.6	49.6	28.6	1.70	1.85	—	9 400	12 000	7209	28.0	52	78	1	0.430
	85	19	1.1	0.6	42.9	24.3	45.1	26.1	1.50	1.60	—	7 000	9 400	7209B	36.4	52	78	1	0.430
	85	19	1.1	0.6	51.0	28.7	53.6	30.9	1.95	2.10	14.2	13 000	17 000	7209C	18.1	52	78	1	0.430
	100	25	1.5	1	68.9	37.1	73.1	40.4	2.55	2.80	—	8 200	10 000	7309	33.6	53.5	91.5	1.5	0.875
	100	25	1.5	1	63.2	34.1	67.0	37.2	2.20	2.40	—	6 200	8 200	7309B	43.1	53.5	91.5	1.5	0.875
	100	25	1.5	1	74.0	39.7	78.4	43.4	2.95	3.20	13.5	11 000	15 000	7309C	22.3	53.5	91.5	1.5	0.875
	120	29	2	1	106	53.8	114	59.8	4.20	4.65	—	5 400	7 100	7409	38.6	55	110	2	1.55
	120	29	2	1	98.7	50.0	106	55.5	3.60	4.00	—	4 800	6 600	7409B	49.5	55	110	2	1.55

[Notes] 1) Limiting speeds shown above are applicable to machined cage bearings. Limiting speeds of pressed cage bearings should be kept to under 80% of this value. For bearings with 15° contact angle, this figure is applied to the high precision bearings ranked higher than class 5, used with machined cage or molded cage.

2) B, C or no indication after the bearing number indicates nominal contact angle of 40°, 15° and 30° respectively. [Remark] Standard cage types used for the above bearings are described earlier in this section.

Single-row angular contact ball bearings

d 50 ~ (60) mm

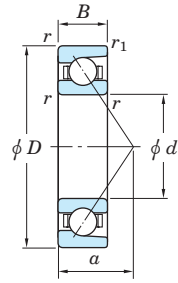

With machined cage

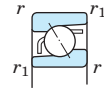

With pressed cage

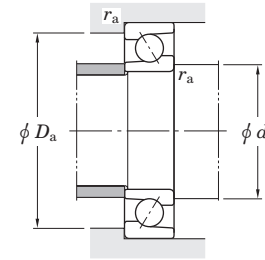

Boundary dimensions (mm)					Basic load ratings (kN)				Fatigue load limits (kN)		Factor	Limiting speeds ¹⁾ (min ⁻¹)		Bearing No. ²⁾	Load center (mm) a	Mounting dimensions (mm)			(Refer.) Mass (kg)
d	D	B	r min.	r1 min.	With machined cage		With pressed cage		Cu			Grease lub.	Oil lub.			da min.	Da max.	ra max.	
					Cr	C0r	Cr	C0r	[With machined cage]	[With pressed cage]	f0								
50	72	12	0.6	0.3	21.8	15.7	—	—	0.840	—	16.2	14 000	18 000	7910C	14.2	54.5	67.5	0.6	0.128
	80	16	1	0.6	29.5	20.1	—	—	1.10	—	—	9 200	11 000	7010	26.9	55.5	74.5	1	0.290
	80	16	1	0.6	26.5	18.1	—	—	0.960	—	—	6 900	9 200	7010B	35.3	55.5	74.5	1	0.290
	80	16	1	0.6	32.5	21.9	—	—	1.25	—	15.7	13 000	17 000	7010C	16.8	55.5	74.5	1	0.290
	90	20	1.1	0.6	49.2	29.4	51.6	31.5	1.80	1.95	—	8 500	11 000	7210	30.4	57	83	1	0.485
	90	20	1.1	0.6	44.6	26.7	46.7	28.6	1.55	1.70	—	6 400	8 500	7210B	39.6	57	83	1	0.485
	90	20	1.1	0.6	53.5	31.8	56.0	34.1	2.05	2.20	14.6	12 000	16 000	7210C	19.4	57	83	1	0.485
	110	27	2	1	87.6	48.1	92.9	52.5	3.35	3.65	—	7 300	9 100	7310	37.2	60	100	2	1.14
	110	27	2	1	80.5	44.3	85.3	48.3	2.90	3.15	—	5 500	7 300	7310B	47.9	60	100	2	1.14
	110	27	2	1	93.9	51.6	99.5	56.2	3.85	4.20	13.4	10 000	13 000	7310C	24.5	60	100	2	1.14
130	31	2.1	1.1	122	65.3	—	—	4.90	—	—	4 900	6 600	7410	41.6	62	118	2	1.92	
130	31	2.1	1.1	113	60.4	—	—	4.20	—	—	4 400	6 000	7410B	53.5	62	118	2	1.92	
55	80	13	1	0.6	24.6	18.5	—	—	0.980	—	16.3	13 000	17 000	7911C	15.5	60.5	74.5	1	0.178
	90	18	1.1	0.6	38.9	26.3	—	—	1.50	—	—	8 300	10 000	7011	29.9	62	83	1	0.420
	90	18	1.1	0.6	34.9	23.7	—	—	1.30	—	—	6 200	8 300	7011B	39.4	62	83	1	0.420
	90	18	1.1	0.6	42.6	28.6	—	—	1.65	—	15.5	11 000	15 000	7011C	18.7	62	83	1	0.420
	100	21	1.5	1	60.9	37.1	63.7	39.8	2.30	2.45	—	7 600	9 500	7211	33.3	63.5	91.5	1.5	0.635
	100	21	1.5	1	55.1	33.8	57.7	36.2	2.00	2.15	—	5 700	7 600	7211B	43.6	63.5	91.5	1.5	0.635
	100	21	1.5	1	66.1	40.2	69.2	43.1	2.60	2.80	14.6	11 000	14 000	7211C	21.1	63.5	91.5	1.5	0.635
	120	29	2	1	101	56.5	107	61.7	3.95	4.30	—	6 700	8 400	7311	40.2	65	110	2	1.45
	120	29	2	1	92.9	52.0	98.4	56.7	3.40	3.70	—	5 000	6 700	7311B	51.8	65	110	2	1.45
	120	29	2	1	108	60.6	115	66.1	4.50	4.90	13.4	9 300	12 000	7311C	26.4	65	110	2	1.45
140	33	2.1	1.1	148	82.4	—	—	6.40	—	—	4 500	6 000	7411	45.0	67	128	2	2.36	
140	33	2.1	1.1	138	76.5	—	—	5.50	—	—	4 000	5 500	7411B	57.8	67	128	2	2.36	
60	85	13	1	0.6	29.0	21.8	—	—	1.15	—	16.3	12 000	16 000	7912C	16.3	65.5	79.5	1	0.187
	95	18	1.1	0.6	39.9	28.1	—	—	1.55	—	—	7 700	9 700	7012	31.4	67	88	1	0.450
	95	18	1.1	0.6	35.7	25.3	—	—	1.35	—	—	5 800	7 700	7012B	41.5	67	88	1	0.450

[Notes] 1) Limiting speeds shown above are applicable to machined cage bearings. Limiting speeds of pressed cage bearings should be kept to under 80% of this value. For bearings with 15° contact angle, this figure is applied to the high precision bearings ranked higher than class 5, used with machined cage or molded cage.

2) B, C or no indication after the bearing number indicates nominal contact angle of 40°, 15° and 30° respectively. [Remark] Standard cage types used for the above bearings are described earlier in this section.

Single-row angular contact ball bearings

d (60) ~ (70) mm

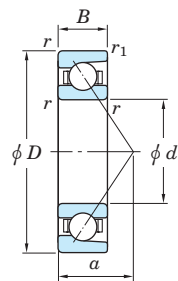

With machined cage

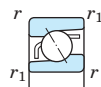

With pressed cage

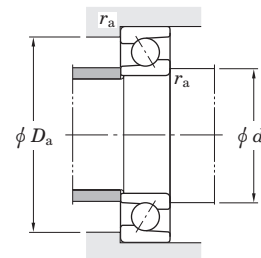

Boundary dimensions (mm)					Basic load ratings (kN)				Fatigue load limits (kN)		Factor	Limiting speeds ¹⁾ (min ⁻¹)		Bearing No. ²⁾	Load center (mm) a	Mounting dimensions (mm)			(Refer.) Mass (kg)
d	D	B	r min.	r ₁ min.	With machined cage		With pressed cage		C _u			Grease lub.	Oil lub.			d _a min.	D _a max.	r _a max.	
60	95	18	1.1	0.6	43.8	30.6	—	—	1.75	—	15.7	11 000	14 000	7012C	19.4	67	88	1	0.450
	110	22	1.5	1	73.7	45.7	77.1	49.0	2.85	3.05	—	6 900	8 600	7212	36.1	68.5	101.5	1.5	0.820
	110	22	1.5	1	66.8	41.6	69.9	44.6	2.45	2.60	—	5 100	6 900	7212B	47.5	68.5	101.5	1.5	0.820
	110	22	1.5	1	80.0	49.5	83.8	53.0	3.20	3.45	14.5	9 500	13 000	7212C	22.7	68.5	101.5	1.5	0.820
	130	31	2.1	1.1	116	65.6	123	71.6	4.55	5.00	—	6 200	7 700	7312	43.2	72	118	2	1.81
	130	31	2.1	1.1	106	60.3	113	65.8	3.95	4.30	—	4 600	6 200	7312B	55.8	72	118	2	1.81
	130	31	2.1	1.1	124	70.3	131	76.7	5.25	5.70	13.4	8 600	11 000	7312C	28.4	72	118	2	1.81
	150	35	2.1	1.1	161	93.6	—	—	6.85	—	—	4 100	5 500	7412	48.5	72	138	2	2.85
150	35	2.1	1.1	149	86.7	—	—	5.90	—	—	3 700	5 100	7412B	62.6	72	138	2	2.85	
65	90	13	1	0.6	25.9	21.2	—	—	1.10	—	16.5	11 000	15 000	7913C	16.9	70.5	84.5	1	0.205
	100	18	1.1	0.6	42.1	31.4	—	—	1.70	—	—	7 200	9 000	7013	33.0	72	93	1	0.470
	100	18	1.1	0.6	37.7	28.3	—	—	1.45	—	—	5 400	7 200	7013B	43.8	72	93	1	0.470
	100	18	1.1	0.6	46.3	34.3	—	—	1.90	—	15.9	10 000	13 000	7013C	20.1	72	93	1	0.470
	120	23	1.5	1	84.1	54.2	87.8	57.8	3.35	3.55	—	6 400	8 000	7213	38.2	73.5	111.5	1.5	1.02
	120	23	1.5	1	76.2	49.3	79.5	52.6	2.90	3.10	—	4 800	6 400	7213B	50.3	73.5	111.5	1.5	1.02
	120	23	1.5	1	91.4	58.7	95.4	62.6	3.80	4.05	14.6	8 900	12 000	7213C	23.9	73.5	111.5	1.5	1.02
	140	33	2.1	1.1	131	75.3	139	82.2	5.15	5.65	—	5 800	7 200	7313	46.3	77	128	2	2.22
	140	33	2.1	1.1	120	69.3	127	75.6	4.45	4.85	—	4 300	5 800	7313B	59.7	77	128	2	2.22
	140	33	2.1	1.1	140	80.7	149	88.1	5.90	6.45	13.4	8 000	11 000	7313C	30.3	77	128	2	2.22
	160	37	2.1	1.1	174	104	—	—	7.40	—	—	3 900	5 200	7413	51.4	77	148	2	3.41
	160	37	2.1	1.1	161	96.8	—	—	6.35	—	—	3 500	4 800	7413B	66.3	77	148	2	3.41
70	100	16	1	0.6	36.2	29.0	—	—	1.55	—	16.4	10 000	12 000	7914C	19.4	75.5	94.5	1	0.332
	110	20	1.1	0.6	53.3	39.4	—	—	2.15	—	—	6 600	8 300	7014	36.0	77	103	1	0.660
	110	20	1.1	0.6	47.8	35.5	—	—	1.90	—	—	5 000	6 600	7014B	47.8	77	103	1	0.660
	110	20	1.1	0.6	58.6	43.0	—	—	2.45	—	15.7	9 200	12 000	7014C	22.1	77	103	1	0.660
	125	24	1.5	1	87.3	55.6	95.4	63.5	3.40	3.90	—	6 100	7 600	7214	40.2	78.5	116.5	1.5	1.12
	125	24	1.5	1	79.0	50.6	86.4	57.8	2.95	3.40	—	4 600	6 100	7214B	52.9	78.5	116.5	1.5	1.12

[Notes] 1) Limiting speeds shown above are applicable to machined cage bearings. Limiting speeds of pressed cage bearings should be kept to under 80% of this value. For bearings with 15° contact angle, this figure is applied to the high precision bearings ranked higher than class 5, used with machined cage or molded cage.

2) B, C or no indication after the bearing number indicates nominal contact angle of 40°, 15° and 30° respectively. [Remark] Standard cage types used for the above bearings are described earlier in this section.

Single-row angular contact ball bearings

d (70) ~ (80) mm

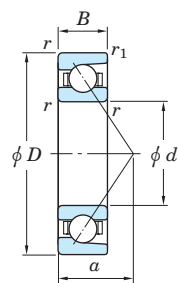

With machined cage

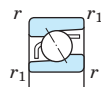

With pressed cage

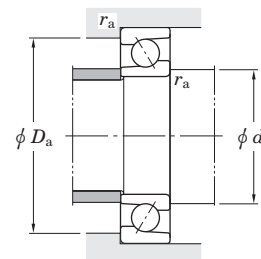

Boundary dimensions (mm)					Basic load ratings (kN)				Fatigue load limits (kN)		Factor	Limiting speeds ¹⁾ (min ⁻¹)		Bearing No. ²⁾	Load center (mm) a	Mounting dimensions (mm)			(Refer.) Mass (kg)
d	D	B	r min.	r1 min.	With machined cage		With pressed cage		Cu			Grease lub.	Oil lub.			da min.	Da max.	ra max.	
70	125	24	1.5	1	94.9	60.2	104	68.8	3.90	4.45	14.6	8 400	11 000	7214C	25.1	78.5	116.5	1.5	1.12
	150	35	2.1	1.1	147	85.8	156	93.6	5.70	6.20	—	5 400	6 700	7314	49.3	82	138	2	2.70
	150	35	2.1	1.1	135	78.9	143	86.0	4.90	5.35	—	4 000	5 400	7314B	63.7	82	138	2	2.70
	150	35	2.1	1.1	158	91.9	167	100	6.50	7.10	13.4	7 500	9 900	7314C	32.2	82	138	2	2.70
	180	42	3	1.1	187	115	—	—	5.30	—	—	3 500	4 600	7414	57.6	84	166	2.5	4.99
	180	42	3	1.1	185	119	—	—	5.45	—	—	3 100	4 300	7414B	74.2	84	166	2.5	4.99
75	105	16	1	0.6	36.7	30.5	—	—	1.60	—	16.5	9 300	12 000	7915C	20.1	80.5	99.5	1	0.350
	115	20	1.1	0.6	54.6	41.7	—	—	2.25	—	—	6 300	7 800	7015	37.4	82	108	1	0.690
	115	20	1.1	0.6	48.8	37.6	—	—	1.95	—	—	4 700	6 300	7015B	49.9	82	108	1	0.690
	115	20	1.1	0.6	60.1	45.6	—	—	2.55	—	15.9	8 700	11 000	7015C	22.7	82	108	1	0.690
	130	25	1.5	1	99.0	65.2	103	69.5	3.95	4.20	—	5 800	7 200	7215	42.1	83.5	121.5	1.5	1.23
	130	25	1.5	1	89.6	59.3	93.6	63.3	3.40	3.65	—	4 300	5 800	7215B	55.5	83.5	121.5	1.5	1.23
	130	25	1.5	1	108	70.6	112	75.3	4.50	4.80	14.6	8 000	11 000	7215C	26.2	83.5	121.5	1.5	1.23
	160	37	2.1	1.1	160	97.0	170	106	6.20	6.75	—	5 000	6 300	7315	52.4	87	148	2	3.15
	160	37	2.1	1.1	147	89.2	156	97.3	5.35	5.85	—	3 800	5 000	7315B	67.8	87	148	2	3.15
	160	37	2.1	1.1	172	104	182	113	7.10	7.75	13.4	7 000	9 200	7315C	34.2	87	148	2	3.15
	190	45	3	1.1	214	141	—	—	6.30	—	—	3 300	4 400	7415	61.3	89	176	2.5	5.90
	190	45	3	1.1	198	131	—	—	5.80	—	—	2 900	4 000	7415B	78.9	89	176	2.5	5.90
80	110	16	1	0.6	37.3	31.6	—	—	1.65	—	16.5	8 800	11 000	7916C	20.7	85.5	104.5	1	0.368
	125	22	1.1	0.6	66.7	50.6	—	—	2.75	—	—	5 800	7 200	7016	40.6	87	118	1	0.930
	125	22	1.1	0.6	59.8	45.7	—	—	2.40	—	—	4 300	5 800	7016B	54.0	87	118	1	0.930
	125	22	1.1	0.6	73.3	55.3	—	—	3.10	—	15.7	8 000	11 000	7016C	24.7	87	118	1	0.930
	140	26	2	1	107	71.5	111	76.2	4.10	4.40	—	5 400	6 700	7216	44.8	90	130	2	1.50
	140	26	2	1	96.4	65.0	101	69.3	3.55	3.80	—	4 000	5 400	7216B	59.2	90	130	2	1.50
	140	26	2	1	116	77.5	121	82.7	4.70	5.00	14.7	7 500	9 900	7216C	27.7	90	130	2	1.50
	170	39	2.1	1.1	174	109	184	119	6.75	7.35	—	4 700	5 900	7316	55.6	92	158	2	3.85
	170	39	2.1	1.1	159	100	169	109	5.80	6.35	—	3 500	4 700	7316B	71.9	92	158	2	3.85

[Notes] 1) Limiting speeds shown above are applicable to machined cage bearings. Limiting speeds of pressed cage bearings should be kept to under 80% of this value. For bearings with 15° contact angle, this figure is applied to the high precision bearings ranked higher than class 5, used with machined cage or molded cage.

2) B, C or no indication after the bearing number indicates nominal contact angle of 40°, 15° and 30° respectively. [Remark] Standard cage types used for the above bearings are described earlier in this section.

Single-row angular contact ball bearings

d (80) ~ 90 mm

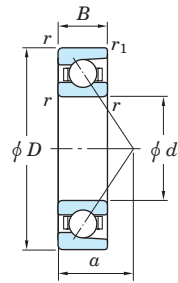

With machined cage

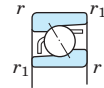

With pressed cage

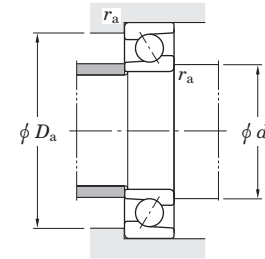

Boundary dimensions (mm)					Basic load ratings (kN)				Fatigue load limits (kN)		Factor	Limiting speeds ¹⁾ (min ⁻¹)		Bearing No. ²⁾	Load center (mm) a	Mounting dimensions (mm)			(Refer.) Mass (kg)
d	D	B	r min.	r_1 min.	With machined cage		With pressed cage		C_u			Grease lub.	Oil lub.			d_a min.	D_a max.	r_a max.	
					C_r	C_{0r}	C_r	C_{0r}	[With machined cage]	[With pressed cage]	f_0								
80	170	39	2.1	1.1	186	117	197	127	7.70	8.40	13.5	6 500	8 600	7316C	36.2	92	158	2	3.85
	200	48	3	1.1	241	166	—	—	7.20	—	—	3 100	4 100	7416	65.0	94	186	2.5	6.00
	200	48	3	1.1	223	154	—	—	6.65	—	—	2 700	3 800	7416B	83.6	94	186	2.5	6.00
85	120	18	1.1	0.6	48.6	40.6	—	—	2.10	—	16.5	8 100	11 000	7917C	22.7	92	113	1	0.523
	130	22	1.1	0.6	68.2	53.7	—	—	2.75	—	—	5 500	6 800	7017	42.3	92	123	1	0.970
	130	22	1.1	0.6	61.0	48.4	—	—	2.40	—	—	4 100	5 500	7017B	56.5	92	123	1	0.970
	130	22	1.1	0.6	75.1	58.7	—	—	3.15	—	15.9	7 600	10 000	7017C	25.5	92	123	1	0.970
	150	28	2	1	123	83.6	129	89.2	4.70	5.00	—	5 000	6 300	7217	47.9	95	140	2	1.87
	150	28	2	1	111	76.0	116	81.1	4.05	4.35	—	3 800	5 000	7217B	63.3	95	140	2	1.87
	150	28	2	1	134	90.6	140	96.6	5.35	5.70	14.7	7 000	9 200	7217C	29.7	95	140	2	1.87
	180	41	3	1.1	187	122	198	133	7.30	7.95	—	4 400	5 500	7317	58.8	99	166	2.5	4.53
	180	41	3	1.1	172	112	182	122	6.30	6.85	—	3 300	4 400	7317B	76.1	99	166	2.5	4.53
	180	41	3	1.1	201	130	213	142	8.35	9.10	13.5	6 100	8 100	7317C	38.3	99	166	2.5	4.53
	210	52	4	1.5	255	180	—	—	7.65	—	—	3 000	3 900	7417	68.7	103	192	3	8.54
210	52	4	1.5	236	167	—	—	7.10	—	—	2 600	3 600	7417B	88.1	103	192	3	8.54	
90	125	18	1.1	0.6	49.5	42.6	—	—	2.15	—	16.6	7 800	10 000	7918C	23.4	97	118	1	0.551
	140	24	1.5	1	81.5	63.3	—	—	3.25	—	—	5 100	6 400	7018	45.2	98.5	131.5	1.5	1.26
	140	24	1.5	1	73.0	57.1	—	—	2.80	—	—	3 900	5 100	7018B	60.2	98.5	131.5	1.5	1.26
	140	24	1.5	1	89.6	69.1	—	—	3.65	—	15.7	7 100	9 400	7018C	27.4	98.5	131.5	1.5	1.26
	160	30	2	1	141	96.7	147	103	5.30	5.65	—	4 700	5 900	7218	51.1	100	150	2	2.30
	160	30	2	1	128	88.0	133	93.8	4.60	4.90	—	3 500	4 700	7218B	67.4	100	150	2	2.30
	160	30	2	1	153	105	160	112	6.00	6.40	14.6	6 500	8 600	7218C	31.7	100	150	2	2.30
	190	43	3	1.1	201	135	213	147	5.90	6.40	—	4 200	5 200	7318	61.9	104	176	2.5	5.30
	190	43	3	1.1	184	124	195	135	5.40	5.90	—	3 100	4 200	7318B	80.2	104	176	2.5	5.30
	190	43	3	1.1	216	145	229	158	6.30	6.90	13.5	5 800	7 700	7318C	40.3	104	176	2.5	5.30
	225	54	4	1.5	270	196	—	—	8.10	—	—	2 800	3 700	7418	72.5	108	207	3	11.4
	225	54	4	1.5	250	182	—	—	7.50	—	—	2 500	3 400	7418B	93.1	108	207	3	11.4

[Notes] 1) Limiting speeds shown above are applicable to machined cage bearings. Limiting speeds of pressed cage bearings should be kept to under 80% of this value. For bearings with 15° contact angle, this figure is applied to the high precision bearings ranked higher than class 5, used with machined cage or molded cage.

2) B, C or no indication after the bearing number indicates nominal contact angle of 40°, 15° and 30° respectively. [Remark] Standard cage types used for the above bearings are described earlier in this section.

Single-row angular contact ball bearings

d 95 ~ (105) mm

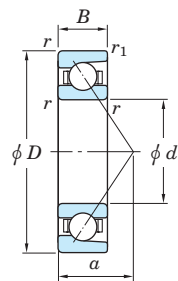

With machined cage

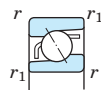

With pressed cage

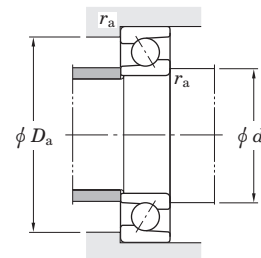

Boundary dimensions (mm)					Basic load ratings (kN)				Fatigue load limits (kN)		Factor	Limiting speeds ¹⁾ (min ⁻¹)		Bearing No. ²⁾	Load center (mm) a	Mounting dimensions (mm)			(Refer.) Mass (kg)
d	D	B	r min.	r1 min.	With machined cage		With pressed cage		Cu			Grease lub.	Oil lub.			da min.	Da max.	ra max.	
					Cr	C0r	Cr	C0r	[With machined cage]	[With pressed cage]	f0								
95	130	18	1.1	0.6	50.3	44.1	—	—	2.15	—	16.5	7 400	9 800	7919C	24.1	102	123	1	0.574
	145	24	1.5	1	83.3	67.1	—	—	3.25	—	—	4 800	6 000	7019	47.2	103.5	136.5	1.5	1.32
	145	24	1.5	1	74.5	60.5	—	—	2.85	—	—	3 600	4 800	7019B	63.2	103.5	136.5	1.5	1.32
	145	24	1.5	1	91.7	73.4	—	—	3.70	—	15.9	6 700	8 900	7019C	28.3	103.5	136.5	1.5	1.32
	170	32	2.1	1.1	153	103	160	111	5.50	5.90	—	4 400	5 500	7219	54.3	107	158	2	2.78
	170	32	2.1	1.1	138	94.0	145	101	4.80	5.10	—	3 300	4 400	7219B	71.6	107	158	2	2.78
	170	32	2.1	1.1	166	112	174	120	6.30	6.75	14.6	6 100	8 100	7219C	33.8	107	158	2	2.78
	200	45	3	1.1	215	149	228	162	6.35	6.90	—	4 000	4 900	7319	65.1	109	186	2.5	6.12
	200	45	3	1.1	197	137	209	149	5.80	6.35	—	3 000	4 000	7319B	84.4	109	186	2.5	6.12
200	45	3	1.1	231	160	245	174	6.80	7.40	13.5	5 500	7 300	7319C	42.3	109	186	2.5	6.12	
100	140	20	1.1	0.6	69.4	58.5	—	—	2.85	—	16.3	7 000	9 200	7920C	26.1	107	133	1	0.773
	150	24	1.5	1	85.5	70.6	—	—	3.35	—	—	4 700	5 900	7020	48.1	108.5	141.5	1.5	1.37
	150	24	1.5	1	76.5	63.6	—	—	2.95	—	—	3 500	4 700	7020B	64.4	108.5	141.5	1.5	1.37
	150	24	1.5	1	94.2	77.2	—	—	3.80	—	16.0	6 500	8 600	7020C	28.7	108.5	141.5	1.5	1.37
	180	34	2.1	1.1	171	117	180	126	6.10	6.50	—	4 100	5 200	7220	57.7	112	168	2	3.32
	180	34	2.1	1.1	155	107	163	115	5.25	5.65	—	3 100	4 200	7220B	76.2	112	168	2	3.32
	180	34	2.1	1.1	186	127	195	136	6.95	7.40	14.6	5 700	7 600	7220C	35.9	112	168	2	3.32
	215	47	3	1.1	229	161	259	194	6.60	7.95	—	3 600	4 600	7320	69.4	114	201	2.5	7.53
	215	47	3	1.1	210	148	238	178	6.10	7.30	—	2 700	3 600	7320B	90.2	114	201	2.5	7.53
215	47	3	1.1	246	173	278	208	7.10	8.50	13.4	5 000	6 700	7320C	44.8	114	201	2.5	7.53	
105	145	20	1.1	0.6	70.8	61.5	—	—	2.90	—	16.4	6 700	8 800	7921C	26.7	112	138	1	0.810
	160	26	2	1	99.7	81.9	—	—	3.80	—	—	4 400	5 500	7021	51.8	115	150	2	1.73
	160	26	2	1	89.2	73.8	—	—	3.30	—	—	3 300	4 400	7021B	68.6	115	150	2	1.73
	160	26	2	1	110	89.6	—	—	4.30	—	15.9	6 000	8 000	7021C	31.0	115	150	2	1.73
	190	36	2.1	1.1	187	132	—	—	6.70	—	—	3 900	4 900	7221	61.0	117	178	2	3.95
	190	36	2.1	1.1	169	121	—	—	5.80	—	—	2 900	3 900	7221B	80.5	117	178	2	3.95

[Notes] 1) Limiting speeds shown above are applicable to machined cage bearings. Limiting speeds of pressed cage bearings should be kept to under 80% of this value. For bearings with 15° contact angle, this figure is applied to the high precision bearings ranked higher than class 5, used with machined cage or molded cage.

2) B, C or no indication after the bearing number indicates nominal contact angle of 40°, 15° and 30° respectively.

[Remark] Standard cage types used for the above bearings are described earlier in this section.

Single-row angular contact ball bearings

d (105) ~ (130) mm

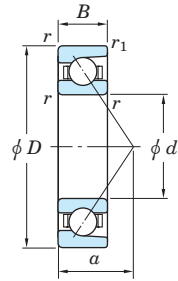

With machined cage

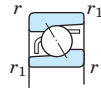

With pressed cage

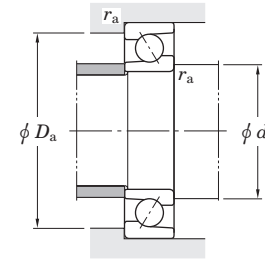

Boundary dimensions (mm)					Basic load ratings (kN)				Fatigue load limits (kN)		Factor	Limiting speeds ¹⁾ (min ⁻¹)		Bearing No. ²⁾	Load center (mm) a	Mounting dimensions (mm)			(Refer.) Mass (kg)
d	D	B	r min.	r1 min.	With machined cage		With pressed cage		Cu			Grease lub.	Oil lub.			da min.	Da max.	ra max.	
					Cr	C0r	Cr	C0r	[With machined cage]	[With pressed cage]	f0								
105	190	36	2.1	1.1	203	143	—	—	7.60	—	14.6	5 400	7 200	7221C	38.0	117	178	2	3.95
	225	49	3	1.1	260	193	—	—	7.75	—	—	3 500	4 400	7321	72.1	119	211	2.5	8.62
	225	49	3	1.1	238	177	—	—	7.15	—	—	2 600	3 500	7321B	93.7	119	211	2.5	8.62
	225	49	3	1.1	278	207	—	—	8.30	—	13.4	4 800	6 400	7321C	46.6	119	211	2.5	8.62
110	150	20	1.1	0.6	72.2	64.4	—	—	2.95	—	16.5	6 400	8 500	7922C	27.4	117	143	1	0.840
	170	28	2	1	115	92.8	—	—	4.30	—	—	4 200	5 200	7022	54.4	120	160	2	2.14
	170	28	2	1	103	83.7	—	—	3.75	—	—	3 100	4 200	7022B	72.7	120	160	2	2.14
	170	28	2	1	126	101	—	—	4.85	—	15.7	5 800	7 700	7022C	32.8	120	160	2	2.14
	200	38	2.1	1.1	202	148	—	—	7.30	—	—	3 700	4 600	7222	64.3	122	188	2	4.65
	200	38	2.1	1.1	183	135	—	—	6.35	—	—	2 800	3 700	7222B	84.9	122	188	2	4.65
	200	38	2.1	1.1	220	160	—	—	8.35	—	14.5	5 100	6 800	7222C	40.0	122	188	2	4.65
	240	50	3	1.1	290	226	—	—	8.75	—	—	3 200	4 000	7322	76.4	124	226	2.5	10.1
	240	50	3	1.1	266	208	—	—	8.05	—	—	2 400	3 200	7322B	99.6	124	226	2.5	10.1
	240	50	3	1.1	311	242	—	—	9.40	—	13.4	4 500	5 900	7322C	48.8	124	226	2.5	10.1
120	165	22	1.1	0.6	89.7	81.2	—	—	3.55	—	16.5	5 900	7 800	7924C	30.1	127	158	1	1.15
	180	28	2	1	121	103	—	—	4.50	—	—	3 900	4 900	7024	57.3	130	170	2	2.27
	180	28	2	1	108	93.0	—	—	3.95	—	—	2 900	3 900	7024B	76.9	130	170	2	2.27
	180	28	2	1	133	113	—	—	5.10	—	16.0	5 400	7 100	7024C	34.1	130	170	2	2.27
	215	40	2.1	1.1	218	166	—	—	7.85	—	—	3 400	4 300	7224	68.5	132	203	2	5.49
	215	40	2.1	1.1	197	151	—	—	6.80	—	—	2 600	3 400	7224B	90.3	132	203	2	5.49
	215	40	2.1	1.1	237	180	—	—	8.95	—	14.6	4 800	6 300	7224C	42.5	132	203	2	5.49
	260	55	3	1.1	308	252	—	—	9.45	—	—	3 000	3 700	7324	82.3	134	246	2.5	12.6
	260	55	3	1.1	282	231	—	—	8.65	—	—	2 200	3 000	7324B	107.2	134	246	2.5	12.6
	260	55	3	1.1	331	271	—	—	10.2	—	13.7	4 100	5 500	7324C	53.0	134	246	2.5	12.6
130	180	24	1.5	1	109	99.9	—	—	4.20	—	16.4	5 400	7 100	7926C	32.8	138.5	171.5	1.5	1.50
	200	33	2	1	147	125	—	—	5.25	—	—	3 500	4 400	7026	64.1	140	190	2	3.43

[Notes] 1) Limiting speeds shown above are applicable to machined cage bearings. Limiting speeds of pressed cage bearings should be kept to under 80% of this value. For bearings with 15° contact angle, this figure is applied to the high precision bearings ranked higher than class 5, used with machined cage or molded cage.

2) B, C or no indication after the bearing number indicates nominal contact angle of 40°, 15° and 30° respectively.

[Remark] Standard cage types used for the above bearings are described earlier in this section.

Single-row angular contact ball bearings

d (130) ~ (150) mm

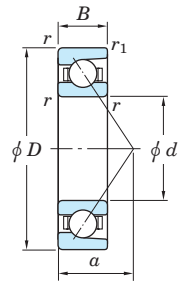

With machined cage

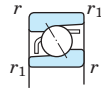

With pressed cage

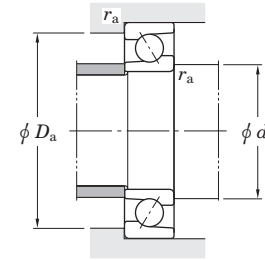

Boundary dimensions (mm)					Basic load ratings (kN)				Fatigue load limits (kN)		Factor	Limiting speeds ¹⁾ (min ⁻¹)		Bearing No. ²⁾	Load center (mm) a	Mounting dimensions (mm)			(Refer.) Mass (kg)
d	D	B	r min.	r1 min.	With machined cage		With pressed cage		Cu			Grease lub.	Oil lub.			da min.	Da max.	ra max.	
130	200	33	2	1	131	113	—	—	4.60	—	—	2 600	3 500	7026B	85.7	140	190	2	3.43
	200	33	2	1	161	137	—	—	5.95	—	15.9	4 800	6 400	7026C	38.6	140	190	2	3.43
	230	40	3	1.1	245	198	—	—	7.60	—	—	3 200	4 000	7226	72.0	144	216	2.5	6.21
	230	40	3	1.1	222	180	—	—	6.95	—	—	2 400	3 200	7226B	95.5	144	216	2.5	6.21
	230	40	3	1.1	266	214	—	—	8.25	—	14.7	4 400	5 800	7226C	44.1	144	216	2.5	6.21
	280	58	4	1.5	376	329	—	—	11.8	—	—	2 700	3 400	7326	88.8	148	262	3	15.4
	280	58	4	1.5	312	268	—	—	9.70	—	—	2 100	2 700	7326B	115.0	148	262	3	15.4
	280	58	4	1.5	368	314	—	—	11.3	—	13.7	3 800	5 000	7326C	56.5	148	262	3	15.4
140	190	24	1.5	1	110	105	—	—	4.20	—	16.6	5 100	6 700	7928C	34.1	148.5	181.5	1.5	1.59
	210	33	2	1	150	133	—	—	5.30	—	—	3 300	4 100	7028	67.0	150	200	2	3.64
	210	33	2	1	134	119	—	—	4.65	—	—	2 500	3 300	7028B	89.9	150	200	2	3.64
	210	33	2	1	165	145	—	—	6.00	—	16.0	4 500	6 000	7028C	39.9	150	200	2	3.64
	250	42	3	1.1	273	234	—	—	8.65	—	—	2 900	3 600	7228	77.3	154	236	2.5	7.76
	250	42	3	1.1	247	213	—	—	7.85	—	—	2 200	2 900	7228B	102.8	154	236	2.5	7.76
	250	42	3	1.1	297	254	—	—	9.40	—	14.8	4 000	5 300	7228C	47.1	154	236	2.5	7.76
	300	62	4	1.5	411	374	—	—	13.0	—	—	2 500	3 200	7328	94.5	158	282	3	18.8
	300	62	4	1.5	378	344	—	—	12.0	—	—	1 900	2 500	7328B	123.3	158	282	3	18.8
	300	62	4	1.5	441	401	—	—	14.0	—	13.4	3 500	4 600	7328C	60.5	158	282	3	18.8
150	210	28	2	1	148	132	—	—	5.45	—	16.3	4 700	6 200	7930C	38.1	160	200	2	2.47
	225	35	2.1	1.1	171	154	—	—	5.95	—	—	3 000	3 800	7030	72.1	162	213	2	4.43
	225	35	2.1	1.1	153	138	—	—	5.20	—	—	2 300	3 000	7030B	96.2	162	213	2	4.43
	225	35	2.1	1.1	188	169	—	—	6.70	—	16.1	4 200	5 500	7030C	42.8	162	213	2	4.43
	270	45	3	1.1	310	280	—	—	9.95	—	—	2 700	3 300	7230	83.1	164	256	2.5	9.75
	270	45	3	1.1	281	254	—	—	9.05	—	—	2 000	2 700	7230B	110.6	164	256	2.5	9.75
	270	45	3	1.1	338	303	—	—	10.8	—	14.7	3 700	4 900	7230C	50.6	164	256	2.5	9.75
	320	65	4	1.5	434	414	—	—	14.0	—	—	2 300	2 900	7330	100.3	168	302	3	22.4
	320	65	4	1.5	397	380	—	—	12.8	—	—	1 800	2 300	7330B	131.1	168	302	3	22.4

[Notes] 1) Limiting speeds shown above are applicable to machined cage bearings. Limiting speeds of pressed cage bearings should be kept to under 80% of this value. For bearings with 15° contact angle, this figure is applied to the high precision bearings ranked higher than class 5, used with machined cage or molded cage.

2) B, C or no indication after the bearing number indicates nominal contact angle of 40°, 15° and 30° respectively.

[Remark] Standard cage types used for the above bearings are described earlier in this section.

Single-row angular contact ball bearings

d (150) ~ (180) mm

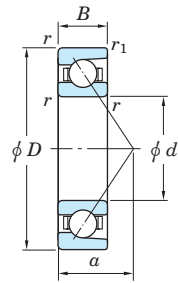

With machined cage

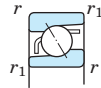

With pressed cage

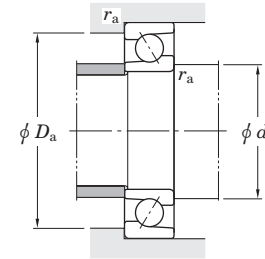

Boundary dimensions (mm)					Basic load ratings (kN)				Fatigue load limits (kN)		Factor	Limiting speeds ¹⁾ (min ⁻¹)		Bearing No. ²⁾	Load center (mm) a	Mounting dimensions (mm)			(Refer.) Mass (kg)
d	D	B	r min.	r1 min.	With machined cage		With pressed cage		C _u			Grease lub.	Oil lub.			d _a min.	D _a max.	r _a max.	
					C _r	C _{0r}	C _r	C _{0r}	[With machined cage]	[With pressed cage]	f ₀								
150	320	65	4	1.5	468	445	—	—	15.0	—	13.7	3 200	4 300	7330C	64.0	168	302	3	22.4
160	220	28	2	1	151	144	—	—	5.45	—	16.5	4 400	5 800	7932C	39.5	170	210	2	2.60
	240	38	2.1	1.1	194	176	—	—	6.65	—	—	2 800	3 500	7032	76.8	172	228	2	5.45
	240	38	2.1	1.1	173	158	—	—	5.80	—	—	2 100	2 800	7032B	102.9	172	228	2	5.45
	240	38	2.1	1.1	214	193	—	—	7.50	—	16.0	3 900	5 200	7032C	45.8	172	228	2	5.45
	290	48	3	1.1	288	263	—	—	9.05	—	—	2 500	3 100	7232	89.0	174	276	2.5	12.1
	290	48	3	1.1	297	279	—	—	9.60	—	—	1 800	2 500	7232B	118.4	174	276	2.5	12.1
	290	48	3	1.1	315	333	—	—	9.85	—	15.2	3 400	4 500	7232C	54.1	174	276	2.5	12.1
	340	68	4	1.5	456	455	—	—	14.9	—	—	2 200	2 700	7332	106.2	178	322	3	26.4
	340	68	4	1.5	415	416	—	—	13.6	—	—	1 600	2 200	7332B	138.9	178	322	3	26.4
	340	68	4	1.5	492	490	—	—	16.0	—	14.0	3 000	4 000	7332C	67.5	168.5	322	3	26.4
170	230	28	2	1	157	151	—	—	5.75	—	16.6	3 900	5 100	7934C	40.8	180	220	2	3.21
	260	42	2.1	1.1	232	214	—	—	7.90	—	—	2 600	3 200	7034	83.1	182	248	2	7.58
	260	42	2.1	1.1	208	193	—	—	6.90	—	—	1 900	2 600	7034B	111.2	182	248	2	7.77
	260	42	2.1	1.1	256	234	—	—	8.95	—	15.9	3 600	4 800	7034C	49.8	182	248	2	7.57
	310	52	4	1.5	340	331	—	—	11.0	—	—	2 300	2 800	7234	95.3	188	292	3	15.1
	310	52	4	1.5	306	300	—	—	10.0	—	—	1 700	2 300	7234B	126.7	188	292	3	15.1
	310	52	4	1.5	371	359	—	—	12.0	—	15.1	3 100	4 200	7234C	58.2	188	292	3	15.1
	360	72	4	1.5	486	485	—	—	15.4	—	—	2 000	2 500	7334	112.5	188	342	3	31.2
	360	72	4	1.5	444	444	—	—	14.1	—	—	1 500	2 000	7334B	147.2	188	342	3	31.2
	360	72	4	1.5	523	521	—	—	16.5	—	13.8	2 800	3 700	7334C	71.5	188	342	3	31.2
180	250	33	2	1	200	188	—	—	7.05	—	16.4	3 600	4 700	7936C	45.3	190	240	2	4.68
	280	46	2.1	1.1	265	253	—	—	9.15	—	—	2 400	3 000	7036	89.4	192	268	2	10.1
	280	46	2.1	1.1	237	228	—	—	7.95	—	—	1 800	2 400	7036B	119.5	192	268	2	10.2
	280	46	2.1	1.1	291	276	—	—	10.4	—	15.7	3 300	4 400	7036C	53.8	192	268	2	9.96
	320	52	4	1.5	367	362	—	—	11.8	—	—	2 200	2 700	7236	98.2	198	302	3	15.7

[Notes] 1) Limiting speeds shown above are applicable to machined cage bearings. Limiting speeds of pressed cage bearings should be kept to under 80% of this value. For bearings with 15° contact angle, this figure is applied to the high precision bearings ranked higher than class 5, used with machined cage or molded cage.

2) B, C or no indication after the bearing number indicates nominal contact angle of 40°, 15° and 30° respectively.

[Remark] Standard cage types used for the above bearings are described earlier in this section.

Single-row angular contact ball bearings

d (180) ~ (240) mm

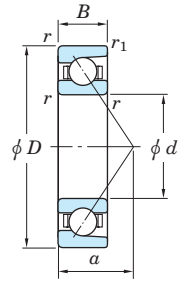

With machined cage

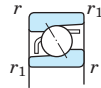

With pressed cage

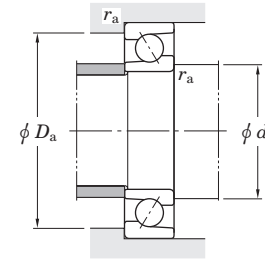

Boundary dimensions (mm)					Basic load ratings (kN)				Fatigue load limits (kN)		Factor	Limiting speeds ¹⁾ (min ⁻¹)		Bearing No. ²⁾	Load center (mm) a	Mounting dimensions (mm)			(Refer.) Mass (kg)
d	D	B	r min.	r1 min.	With machined cage		With pressed cage		C _u			Grease lub.	Oil lub.			d _a min.	D _a max.	r _a max.	
					C _r	C _{0r}	C _r	C _{0r}	[With machined cage]	[With pressed cage]	f ₀								
180	320	52	4	1.5	331	329	—	—	10.7	—	—	1 600	2 200	7236B	130.9	198	302	3	15.7
	320	52	4	1.5	400	393	—	—	12.8	—	14.9	3 000	4 000	7236C	59.5	198	302	3	15.7
	380	75	4	1.5	512	534	—	—	16.5	—	—	1 900	2 400	7336	118.3	198	362	3	40.0
	380	75	4	1.5	466	488	—	—	15.1	—	—	1 400	1 900	7336B	155.0	198	362	3	40.0
190	260	33	2	1	198	197	—	—	6.85	—	16.5	3 300	4 500	7938C	46.6	200	250	2	4.83
	290	46	2.1	1.1	271	268	—	—	9.35	—	—	2 300	2 800	7038	92.3	202	278	2	10.8
	290	46	2.1	1.1	243	241	—	—	8.15	—	—	1 700	2 300	7038B	123.7	202	278	2	10.8
	290	46	2.1	1.1	299	293	—	—	10.6	—	15.9	3 100	4 200	7038C	55.2	202	278	2	10.8
	340	55	4	1.5	379	390	—	—	12.4	—	—	2 000	2 500	7238	104.0	208	322	3	18.8
	340	55	4	1.5	341	353	—	—	11.2	—	—	1 500	2 000	7238B	138.7	208	322	3	18.8
	340	55	4	1.5	414	424	—	—	13.5	—	15.1	2 800	3 700	7238C	63.0	208	322	3	18.8
	400	78	5	2	563	598	—	—	18.0	—	—	1 800	2 200	7338	124.2	212	378	4	45.5
400	78	5	2	514	548	—	—	16.5	—	—	1 300	1 800	7338B	162.8	212	378	4	45.5	
200	280	38	2.1	1.1	256	255	—	—	8.70	—	16.3	3 100	4 100	7940C	51.2	212	268	2	6.85
	310	51	2.1	1.1	304	309	—	—	10.0	—	—	2 100	2 600	7040	99.1	212	298	2	12.7
	310	51	2.1	1.1	273	279	—	—	9.05	—	—	1 600	2 100	7040B	132.5	212	298	2	12.7
	310	51	2.1	1.1	335	338	—	—	10.9	—	15.7	2 900	3 900	7040C	59.7	212	298	2	12.7
	360	58	4	1.5	405	423	—	—	13.1	—	—	1 900	2 400	7240	109.8	218	342	3	22.4
	360	58	4	1.5	365	384	—	—	11.9	—	—	1 400	1 900	7240B	146.5	218	342	3	22.4
	360	58	4	1.5	442	460	—	—	14.2	—	15.1	2 600	3 500	7240C	66.5	218	342	3	22.4
	420	80	5	2	593	658	—	—	19.3	—	—	1 700	2 100	7340	129.5	222	398	4	52.0
420	80	5	2	541	602	—	—	17.7	—	—	1 200	1 700	7340B	170.1	222	398	4	52.0	
220	340	56	3	1.1	334	353	—	—	10.9	—	—	1 900	2 400	7044	108.9	234	326	2.5	18.5
	340	56	3	1.1	299	318	—	—	9.80	—	—	1 400	1 900	7044B	145.5	234	326	2.5	18.9
240	360	56	3	1.1	364	375	—	—	12.3	—	—	1 700	2 200	7048	114.6	254	346	2.5	19.7
	360	56	3	1.1	325	338	—	—	11.1	—	—	1 300	1 700	7048B	153.9	254	346	2.5	20.1

[Notes] 1) Limiting speeds shown above are applicable to machined cage bearings. Limiting speeds of pressed cage bearings should be kept to under 80% of this value. For bearings with 15° contact angle, this figure is applied to the high precision bearings ranked higher than class 5, used with machined cage or molded cage.

2) B, C or no indication after the bearing number indicates nominal contact angle of 40°, 15° and 30° respectively.

[Remark] Standard cage types used for the above bearings are described earlier in this section.

Single-row angular contact ball bearings

d (240) ~ 380 mm

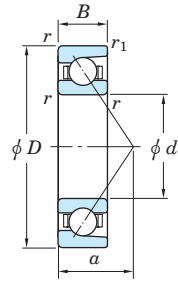

With machined cage

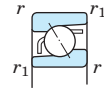

With pressed cage

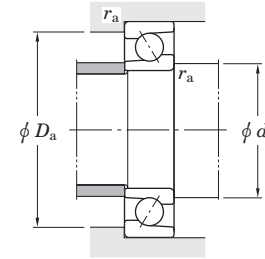

Boundary dimensions (mm)				Basic load ratings (kN)				Fatigue load limits (kN)		Factor	Limiting speeds ¹⁾ (min ⁻¹)		Bearing No. ²⁾	Load center (mm) a	Mounting dimensions (mm)			(Refer.) Mass (kg)
d	D	B	r min.	r_1 min.	With machined cage C_r	With pressed cage C_{0r}	With machined cage C_u	With pressed cage C_u	Grease lub.		Oil lub.	d_a min.			D_a max.	r_a max.		
240	440	72	4	1.5	504	595	16.7	—	—	1 500	1 800	7248	134.2	258	422	3	51.8	
	440	72	4	1.5	453	539	15.1	—	—	1 100	1 500	7248B	178.6	258	422	3	52.8	
260	400	65	4	1.5	407	478	13.6	—	—	1 500	1 900	7052	128.4	278	382	3	28.7	
	400	65	4	1.5	364	431	12.2	—	—	1 100	1 500	7052B	171.0	278	382	3	29.3	
280	420	65	4	1.5	415	507	14.0	—	—	1 400	1 800	7056	133.5	298	402	3	30.4	
	420	65	4	1.5	384	453	13.1	—	—	1 100	1 400	7056B	179.3	298	402	3	31.0	
300	460	74	4	1.5	533	680	18.0	—	—	1 300	1 600	7060	146.7	318	442	3	43.7	
	460	74	4	1.5	478	613	16.3	—	—	960	1 300	7060B	196.4	318	442	3	44.9	
320	480	74	4	1.5	546	722	18.6	—	—	1 200	1 500	7064	152.5	338	462	3	46.0	
	480	74	4	1.5	489	651	16.8	—	—	890	1 200	7064B	204.8	338	462	3	47.2	
340	520	82	5	2	628	861	21.4	—	—	1 100	1 300	7068	165.1	362	498	4	61.8	
	520	82	5	2	563	777	19.4	—	—	800	1 100	7068B	221.4	362	498	4	63.3	
360	540	82	5	2	644	913	22.2	—	—	1 000	1 300	7072	170.9	382	518	4	64.6	
	540	82	5	2	577	824	20.1	—	—	750	1 000	7072B	229.8	382	518	4	66.2	
380	560	82	5	2	660	966	23.0	—	—	940	1 200	7076	176.7	402	538	4	67.2	
	560	82	5	2	590	870	20.7	—	—	700	940	7076B	238.2	402	538	4	69.1	

[Notes] 1) Limiting speeds shown above are applicable to machined cage bearings. Limiting speeds of pressed cage bearings should be kept to under 80% of this value. For bearings with 15° contact angle, this figure is applied to the high precision bearings ranked higher than class 5, used with machined cage or molded cage.

2) B or no indication after the bearing number indicates nominal contact angle of 15° and 30° respectively.

[Remark] Standard cage types used for the above bearings are described earlier in this section.

Angular contact ball bearings (matched pair)

d 10 ~ (17) mm

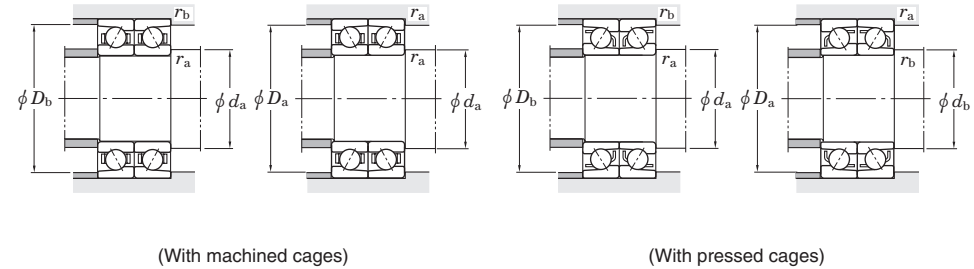
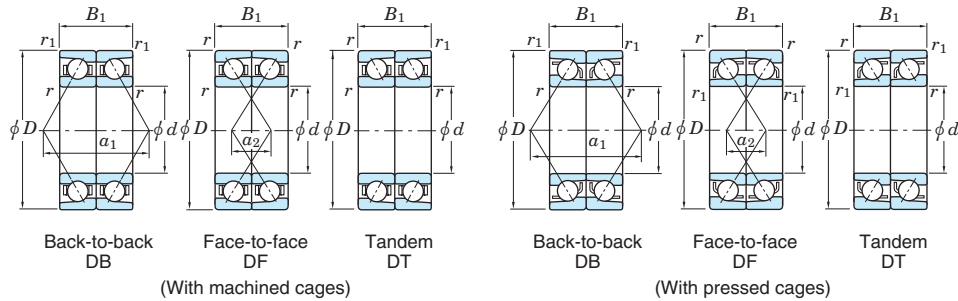

Boundary dimensions (mm)					Basic load ratings (kN)				Fatigue load limits (kN)		Factor	Limiting speeds ¹⁾ (min ⁻¹)		Bearing No. ²⁾			Load center spread (mm)		Mounting dimensions (mm)						(Refer.) Mass (kg)
d	D	B ₁	r _{min.}	r _{1 min.}	With machined cages		With pressed cages		C _u	f ₀	Grease lub.	Oil lub.	Back-to-back DB	Face-to-face DF	Tandem DT	a ₁	a ₂	d _{a min.}	d _{b min.}	D _{a max.}	D _{b max.}	r _{a max.}	r _{b max.}	Mass	
					C _r	C _{0r}	C _r	C _{0r}																	(With machined cages)
10	22	12	0.3	0.15	6.10	3.05	—	—	0.120	—	14.2	42 000	55 000	7900CDB	7900CDF	7900CDT	10.3	1.7	12.5	—	19.5	20.8	0.3	0.15	0.016
	26	16	0.3	0.15	10.1	4.65	—	—	0.240	—	—	27 000	34 000	7000DB	7000DF	7000DT	18.2	2.2	12.5	—	23.5	24.8	0.3	0.15	0.042
	26	16	0.3	0.15	9.40	4.35	—	—	0.220	—	—	20 000	27 000	7000BDB	7000BDF	7000BDT	23.1	7.1	12.5	—	23.5	24.8	0.3	0.15	0.042
	26	16	0.3	0.15	10.7	4.95	—	—	0.250	—	12.5	37 000	50 000	7000CDB	7000CDF	7000CDT	12.7	3.3	12.5	—	23.5	24.8	0.3	0.15	0.042
	30	18	0.6	0.3	9.50	4.40	11.0	5.45	0.230	0.280	—	23 000	29 000	7200DB	7200DF	7200DT	20.8	2.8	14.5	12.5	25.5	27.5	0.6	0.3	0.062
	30	18	0.6	0.3	8.70	4.05	10.1	5.05	0.210	0.260	—	18 000	23 000	7200BDB	7200BDF	7200BDT	26.2	8.2	14.5	12.5	25.5	27.5	0.6	0.3	0.062
	30	18	0.6	0.3	10.2	4.70	11.8	5.85	0.240	0.300	13.4	32 000	43 000	7200CDB	7200CDF	7200CDT	14.5	3.5	14.5	12.5	25.5	27.5	0.6	0.3	0.062
	35	22	0.6	0.3	17.3	7.55	18.9	8.60	0.590	0.680	—	21 000	27 000	7300DB	7300DF	7300DT	24.0	2.0	14.5	12.5	30.5	32.5	0.6	0.3	0.108
12	24	12	0.3	0.15	6.45	3.45	—	—	0.140	—	14.7	37 000	49 000	7901CDB	7901CDF	7901CDT	10.8	1.2	14.5	—	21.5	22.8	0.3	0.15	0.020
	28	16	0.3	0.15	11.0	5.45	—	—	0.280	—	—	23 000	29 000	7001DB	7001DF	7001DT	19.9	3.9	14.5	—	25.5	26.8	0.3	0.15	0.048
	28	16	0.3	0.15	10.1	5.05	—	—	0.260	—	—	18 000	23 000	7001BDB	7001BDF	7001BDT	25.2	9.2	14.5	—	25.5	26.8	0.3	0.15	0.048
	28	16	0.3	0.15	11.8	5.85	—	—	0.300	—	13.4	32 000	43 000	7001CDB	7001CDF	7001CDT	13.5	2.5	14.5	—	25.5	26.8	0.3	0.15	0.048
	32	20	0.6	0.3	15.1	7.25	16.2	8.05	0.560	0.620	—	22 000	27 000	7201DB	7201DF	7201DT	22.7	2.7	16.5	14.5	27.5	29.5	0.6	0.3	0.076
	32	20	0.6	0.3	14.0	6.80	15.1	7.50	0.480	0.530	—	16 000	22 000	7201BDB	7201BDF	7201BDT	28.5	8.5	16.5	14.5	27.5	29.5	0.6	0.3	0.076
	32	20	0.6	0.3	16.0	7.70	17.2	8.55	0.600	0.670	12.5	30 000	40 000	7201CDB	7201CDF	7201CDT	15.9	4.1	16.5	14.5	27.5	29.5	0.6	0.3	0.076
	37	24	1	0.6	20.7	9.20	22.7	10.5	0.720	0.820	—	20 000	24 000	7301DB	7301DF	7301DT	26.2	2.2	17.5	16.5	31.5	32.5	1	0.6	0.130
15	28	14	0.3	0.15	9.65	5.30	—	—	0.210	—	14.5	31 000	41 000	7902CDB	7902CDF	7902CDT	12.8	1.2	17.5	—	25.5	26.8	0.3	0.15	0.030
	32	18	0.3	0.15	12.4	6.85	—	—	0.350	—	—	20 000	26 000	7002DB	7002DF	7002DT	22.6	4.6	17.5	—	29.5	30.8	0.3	0.15	0.070
	32	18	0.3	0.15	11.3	6.30	—	—	0.320	—	—	15 000	20 000	7002BDB	7002BDF	7002BDT	29.1	11.1	17.5	—	29.5	30.8	0.3	0.15	0.070
	32	18	0.3	0.15	13.4	7.40	—	—	0.380	—	14.1	28 000	37 000	7002CDB	7002CDF	7002CDT	15.3	2.7	17.5	—	29.5	30.8	0.3	0.15	0.070
	35	22	0.6	0.3	16.4	8.55	16.4	8.55	0.600	0.600	—	19 000	24 000	7202DB	7202DF	7202DT	25.7	3.7	19.5	17.5	30.5	32.5	0.6	0.3	0.096
	35	22	0.6	0.3	15.1	7.85	15.1	7.85	0.520	0.520	—	14 000	19 000	7202BDB	7202BDF	7202BDT	32.4	10.4	19.5	17.5	30.5	32.5	0.6	0.3	0.096
	35	22	0.6	0.3	17.6	9.15	17.6	9.15	0.680	0.680	13.3	26 000	35 000	7202CDB	7202CDF	7202CDT	17.8	4.2	19.5	17.5	30.5	32.5	0.6	0.3	0.096
	42	26	1	0.6	25.4	12.9	27.3	14.4	0.990	1.10	—	16 000	20 000	7302DB	7302DF	7302DT	30.0	4.0	20.5	19.5	36.5	37.5	1	0.6	0.176
17	30	14	0.3	0.15	10.1	5.90	—	—	0.240	—	14.9	28 000	38 000	7903CDB	7903CDF	7903CDT	13.4	0.6	19.5	—	27.5	28.8	0.3	0.15	0.032
	35	20	0.3	0.15	13.7	8.25	—	—	0.430	—	—	18 000	23 000	7003DB	7003DF	7003DT	25.3	5.3	19.5	—	32.5	33.8	0.3	0.15	0.090
	35	20	0.3	0.15	12.4	7.50	—	—	0.390	—	—	14 000	18 000	7003BDB	7003BDF	7003BDT	32.2	12.2	19.5	—	32.5	33.8	0.3	0.15	0.090

[Notes] 1) Limiting speeds shown above are applicable to machined cage bearings. Limiting speeds of pressed cage bearings should be kept to under 80% of this value. For bearings with 15° contact angle, this figure is applied to the high precision bearings ranked higher than class 5, used with machined cages or molded cages.

2) B, C or no indication after the bearing number indicates nominal contact angle of 40°, 15° and 30° respectively. [Remark] Standard cage types used for the above bearings are described earlier in this section.

Angular contact ball bearings (matched pair)

d (17) ~ (25) mm

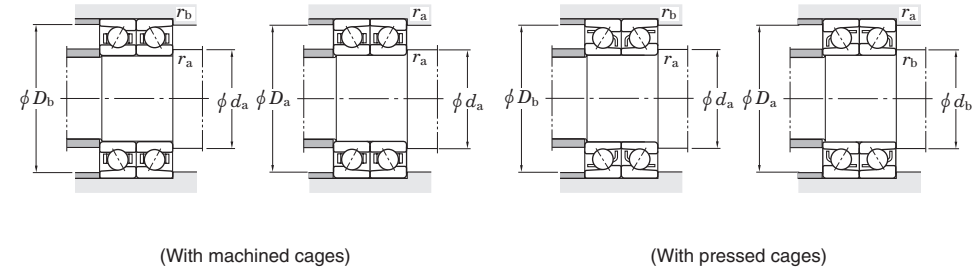
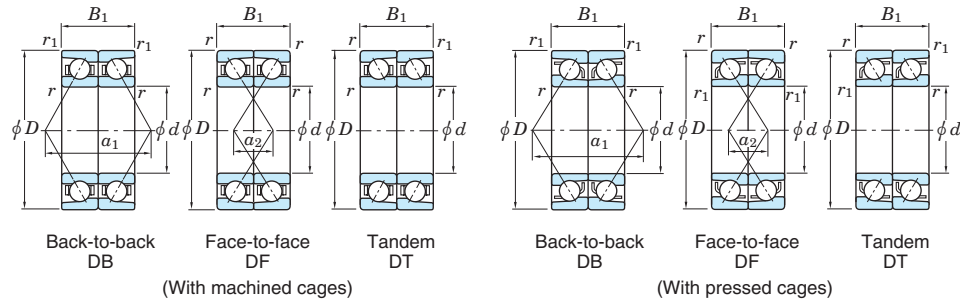

Boundary dimensions (mm)					Basic load ratings (kN)				Fatigue load limits (kN)		Factor	Limiting speeds ¹⁾ (min ⁻¹)		Bearing No. ²⁾			Load center spread (mm)		Mounting dimensions (mm)						(Refer.) Mass (kg)
d	D	B ₁	r _{min.}	r _{1 min.}	With machined cages		With pressed cages		C _u	f ₀	Grease lub.	Oil lub.	Back-to-back DB	Face-to-face DF	Tandem DT	a ₁	a ₂	d _{a min.}	d _{b min.}	D _{a max.}	D _{b max.}	r _{a max.}	r _{b max.}		
					C _r	C _{0r}	C _r	C _{0r}																	(With machined cages)
17	35	20	0.3	0.15	14.8	8.95	—	—	0.460	—	14.6	25 000	33 000	7003CDB	7003CDF	7003CDT	17.1	2.9	19.5	—	32.5	33.8	0.3	0.15	0.090
	40	24	0.6	0.3	20.6	11.0	20.6	11.0	0.770	0.770	—	17 000	21 000	7203DB	7203DF	7203DT	28.8	4.8	21.5	19.5	35.5	37.5	0.6	0.3	0.140
	40	24	0.6	0.3	19.0	10.1	19.0	10.1	0.660	0.660	—	12 000	17 000	7203BDB	7203BDF	7203BDT	36.3	12.3	21.5	19.5	35.5	37.5	0.6	0.3	0.140
	40	24	0.6	0.3	22.1	11.8	22.1	11.8	0.880	0.880	13.4	23 000	30 000	7203CDB	7203CDF	7203CDT	19.8	4.2	21.5	19.5	35.5	37.5	0.6	0.3	0.140
	47	28	1	0.6	30.3	15.8	32.5	17.5	1.20	1.30	—	15 000	18 000	7303DB	7303DF	7303DT	33.1	5.1	22.5	21.5	41.5	42.5	1	0.6	0.240
	47	28	1	0.6	28.1	14.6	30.1	16.2	1.00	1.15	—	11 000	15 000	7303BDB	7303BDF	7303BDT	41.7	13.7	22.5	21.5	41.5	42.5	1	0.6	0.240
	47	28	1	0.6	32.2	16.8	32.2	16.8	1.30	1.30	12.6	20 000	27 000	7303CDB	7303CDF	7303CDT	22.8	5.2	22.5	21.5	41.5	42.5	1	0.6	0.240
20	37	18	0.3	0.15	14.8	9.15	—	—	0.470	—	14.9	24 000	31 000	7904CDB	7904CDF	7904CDT	16.6	1.4	22.5	—	34.5	35.8	0.3	0.15	0.070
	42	24	0.6	0.3	20.9	12.2	—	—	0.790	—	—	15 000	19 000	7004DB	7004DF	7004DT	30.2	6.2	24.5	—	37.5	39.5	0.6	0.3	0.158
	42	24	0.6	0.3	19.0	11.1	—	—	0.680	—	—	11 000	15 000	7004BDB	7004BDF	7004BDT	38.4	14.4	24.5	—	37.5	39.5	0.6	0.3	0.158
	42	24	0.6	0.3	22.6	13.2	—	—	0.900	—	14.1	21 000	28 000	7004CDB	7004CDF	7004CDT	20.4	3.6	24.5	—	37.5	39.5	0.6	0.3	0.158
	47	28	1	0.6	29.4	16.8	31.2	18.3	1.15	1.25	—	14 000	17 000	7204DB	7204DF	7204DT	33.9	5.9	25.5	24.5	41.5	42.5	1	0.6	0.224
	47	28	1	0.6	27.0	15.4	28.6	16.8	1.00	1.10	—	10 000	14 000	7204BDB	7204BDF	7204BDT	42.9	14.9	25.5	24.5	41.5	42.5	1	0.6	0.224
	47	28	1	0.6	31.5	18.0	33.4	19.6	1.35	1.45	13.4	19 000	26 000	7204CDB	7204CDF	7204CDT	23.2	4.8	25.5	24.5	41.5	42.5	1	0.6	0.224
	52	30	1.1	0.6	35.4	18.8	38.0	20.8	1.40	1.60	—	13 000	17 000	7304DB	7304DF	7304DT	35.8	5.8	27	24.5	45	47.5	1	0.6	0.300
	52	30	1.1	0.6	32.8	17.4	35.2	19.3	1.20	1.35	—	10 000	13 000	7304BDB	7304BDF	7304BDT	45.2	15.2	27	24.5	45	47.5	1	0.6	0.300
	52	30	1.1	0.6	37.6	19.9	40.3	22.2	1.55	1.75	12.6	18 000	24 000	7304CDB	7304CDF	7304CDT	24.6	5.4	27	24.5	45	47.5	1	0.6	0.300
	72	38	1.1	0.6	72.3	38.2	—	—	3.00	—	—	7 400	11 000	7404DB	7404DF	7404DT	46.1	8.1	27	—	65	67.5	1	0.6	0.790
	72	38	1.1	0.6	68.1	35.9	—	—	2.80	—	—	6 400	9 600	7404BDB	7404BDF	7404BDT	58.4	20.4	27	—	65	67.5	1	0.6	0.790
25	42	18	0.3	0.15	16.5	10.9	—	—	0.600	—	15.5	20 000	27 000	7905CDB	7905CDF	7905CDT	18.2	0.2	27.5	—	39.5	40.8	0.3	0.15	0.082
	47	24	0.6	0.3	22.9	14.8	—	—	0.900	—	—	13 000	17 000	7005DB	7005DF	7005DT	32.9	8.9	29.5	—	42.5	44.5	0.6	0.3	0.182
	47	24	0.6	0.3	20.7	13.4	—	—	0.780	—	—	10 000	13 000	7005BDB	7005BDF	7005BDT	42.3	18.3	29.5	—	42.5	44.5	0.6	0.3	0.182
	47	24	0.6	0.3	24.9	16.0	—	—	1.00	—	14.7	18 000	24 000	7005CDB	7005CDF	7005CDT	21.7	2.3	29.5	—	42.5	44.5	0.6	0.3	0.182
	52	30	1	0.6	31.2	19.0	32.9	20.6	1.25	1.35	—	12 000	15 000	7205DB	7205DF	7205DT	37.5	7.5	30.5	29.5	46.5	47.5	1	0.6	0.270
	52	30	1	0.6	28.4	17.4	29.9	18.8	1.05	1.15	—	9 200	12 000	7205BDB	7205BDF	7205BDT	47.7	17.7	30.5	29.5	46.5	47.5	1	0.6	0.270
	52	30	1	0.6	33.7	20.5	35.5	22.2	1.40	1.55	14.0	17 000	23 000	7205CDB	7205CDF	7205CDT	25.5	4.5	30.5	29.5	46.5	47.5	1	0.6	0.270
	62	34	1.1	0.6	50.3	28.8	53.6	31.6	2.10	2.35	—	11 000	14 000	7305DB	7305DF	7305DT	42.1	8.1	32	29.5	55	57.5	1	0.6	0.486

[Notes] 1) Limiting speeds shown above are applicable to machined cage bearings. Limiting speeds of pressed cage bearings should be kept to under 80% of this value. For bearings with 15° contact angle, this figure is applied to the high precision bearings ranked higher than class 5, used with machined cages or molded cages.

2) B, C or no indication after the bearing number indicates nominal contact angle of 40°, 15° and 30° respectively. [Remark] Standard cage types used for the above bearings are described earlier in this section.

Angular contact ball bearings (matched pair)

d (25) ~ (35) mm

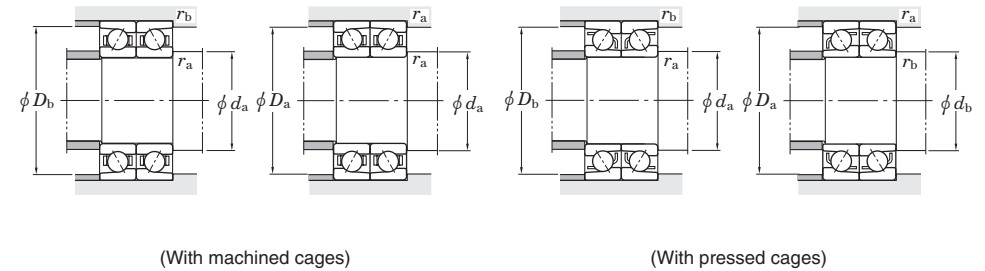
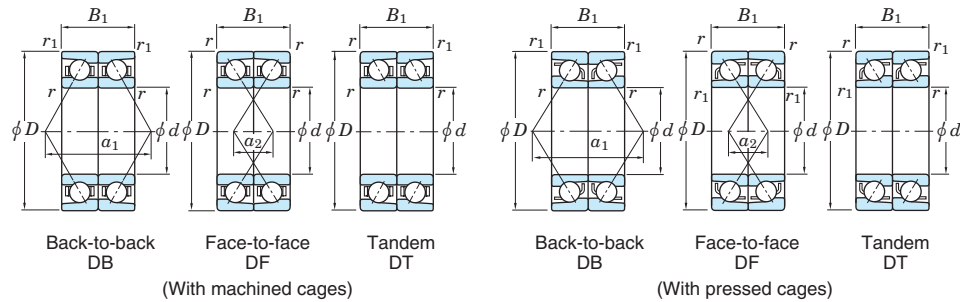

Boundary dimensions (mm)					Basic load ratings (kN)				Fatigue load limits (kN)		Factor	Limiting speeds ¹⁾ (min ⁻¹)		Bearing No. ²⁾			Load center spread (mm)		Mounting dimensions (mm)						(Refer.) Mass (kg)
d	D	B ₁	r _{min.}	r _{1 min.}	With machined cages		With pressed cages		C _u	f ₀		Grease lub.	Oil lub.	Back-to-back DB	Face-to-face DF	Tandem DT	a ₁	a ₂	d _{a min.}	d _{b min.}	D _{a max.}	D _{b max.}	r _{a max.}	r _{b max.}	
25	62	34	1.1	0.6	46.5	26.6	49.5	29.2	1.85	2.00	—	8 300	11 000	7305BDB	7305BDF	7305BDT	53.5	19.5	32	29.5	55	57.5	1	0.6	0.486
	62	34	1.1	0.6	53.5	30.6	57.0	33.7	2.40	2.65	12.8	15 000	20 000	7305CDB	7305CDF	7305CDT	28.7	5.3	32	29.5	55	57.5	1	0.6	0.486
	80	42	1.5	1	80.7	46.3	86.6	51.5	3.60	4.00	—	6 400	9 100	7405DB	7405DF	7405DT	52.8	10.8	33.5	30.5	71.5	74.5	1.5	1	1.05
	80	42	1.5	1	74.9	43.0	80.4	47.8	3.10	3.40	—	5 500	8 200	7405BDB	7405BDF	7405BDT	67.2	25.2	33.5	30.5	71.5	74.5	1.5	1	1.05
30	47	18	0.3	0.15	16.8	12.5	—	—	0.650	—	15.9	18 000	23 000	7906CDB	7906CDF	7906CDT	19.3	1.3	32.5	—	44.5	45.8	0.3	0.15	0.092
	55	26	1	0.6	29.5	20.2	—	—	1.20	—	—	11 000	14 000	7006DB	7006DF	7006DT	37.5	11.5	35.5	—	49.5	50.5	1	0.6	0.266
	55	26	1	0.6	26.7	18.4	—	—	1.05	—	—	8 500	11 000	7006BDB	7006BDF	7006BDT	48.7	22.7	35.5	—	49.5	50.5	1	0.6	0.266
	55	26	1	0.6	32.2	22.0	—	—	1.40	—	14.9	16 000	21 000	7006CDB	7006CDF	7006CDT	24.4	1.6	35.5	—	49.5	50.5	1	0.6	0.266
	62	32	1	0.6	43.3	27.4	45.7	29.7	1.80	1.95	—	10 000	13 000	7206DB	7206DF	7206DT	43.0	11.0	35.5	34.5	56.5	57.5	1	0.6	0.416
	62	32	1	0.6	39.5	25.0	41.6	27.1	1.55	1.65	—	7 700	10 000	7206BDB	7206BDF	7206BDT	55.2	23.2	35.5	34.5	56.5	57.5	1	0.6	0.416
	62	32	1	0.6	46.8	29.5	49.4	32.0	2.05	2.20	14.0	14 000	19 000	7206CDB	7206CDF	7206CDT	28.5	3.5	35.5	34.5	56.5	57.5	1	0.6	0.416
	72	38	1.1	0.6	61.1	37.8	64.8	41.2	2.60	2.85	—	9 200	12 000	7306DB	7306DF	7306DT	49.0	11.0	37	34.5	65	67.5	1	0.6	0.724
	72	38	1.1	0.6	56.1	34.7	59.4	37.9	2.25	2.45	—	6 900	9 200	7306BDB	7306BDF	7306BDT	62.6	24.6	37	34.5	65	67.5	1	0.6	0.724
	72	38	1.1	0.6	65.6	40.5	69.5	44.2	3.00	3.25	13.4	13 000	17 000	7306CDB	7306CDF	7306CDT	32.9	5.1	37	34.5	65	67.5	1	0.6	0.724
	90	46	1.5	1	96.7	56.9	104	63.2	4.35	4.85	—	5 700	8 100	7406DB	7406DF	7406DT	58.5	12.5	38.5	35.5	81.5	84.5	1.5	1	1.37
	90	46	1.5	1	89.7	52.8	96.3	58.6	3.75	4.15	—	4 900	7 300	7406BDB	7406BDF	7406BDT	74.6	28.6	38.5	35.5	81.5	84.5	1.5	1	1.37
35	55	20	0.6	0.3	25.5	19.4	—	—	1.10	—	15.7	15 000	20 000	7907CDB	7907CDF	7907CDT	22.1	2.1	39.5	—	50.5	52.5	0.6	0.3	0.148
	62	28	1	0.6	35.5	25.2	—	—	1.50	—	—	9 800	12 000	7007DB	7007DF	7007DT	42.3	14.3	40.5	—	56.5	57.5	1	0.6	0.340
	62	28	1	0.6	32.0	22.8	—	—	1.30	—	—	7 300	9 800	7007BDB	7007BDF	7007BDT	55.1	27.1	40.5	—	56.5	57.5	1	0.6	0.340
	62	28	1	0.6	38.8	27.4	—	—	1.70	—	15.0	13 000	18 000	7007CDB	7007CDF	7007CDT	27.0	1.0	40.5	—	56.5	57.5	1	0.6	0.340
	72	34	1.1	0.6	57.1	37.3	60.3	40.4	2.45	2.65	—	8 800	11 000	7207DB	7207DF	7207DT	48.5	14.5	42	39.5	65	67.5	1	0.6	0.590
	72	34	1.1	0.6	52.1	34.1	54.9	36.9	2.10	2.25	—	6 600	8 800	7207BDB	7207BDF	7207BDT	62.7	28.7	42	39.5	65	67.5	1	0.6	0.590
	72	34	1.1	0.6	61.7	40.2	65.1	43.5	2.75	3.00	14.0	12 000	16 000	7207CDB	7207CDF	7207CDT	31.6	2.4	42	39.5	65	67.5	1	0.6	0.590
	80	42	1.5	1	71.8	44.0	81.1	52.8	3.05	3.65	—	8 200	10 000	7307DB	7307DF	7307DT	54.8	12.8	43.5	40.5	71.5	74.5	1.5	1	0.950
	80	42	1.5	1	65.9	40.5	74.4	48.6	2.65	3.15	—	6 200	8 200	7307BDB	7307BDF	7307BDT	70.1	28.1	43.5	40.5	71.5	74.5	1.5	1	0.950
	80	42	1.5	1	77.0	47.2	86.9	56.6	3.50	4.20	13.4	11 000	15 000	7307CDB	7307CDF	7307CDT	36.7	5.3	43.5	40.5	71.5	74.5	1.5	1	0.950
	100	50	1.5	1	123	73.9	132	82.1	5.70	6.35	—	5 000	7 200	7407DB	7407DF	7407DT	65.2	15.2	43.5	40.5	91.5	94.5	1.5	1	1.90

[Notes] 1) Limiting speeds shown above are applicable to machined cage bearings. Limiting speeds of pressed cage bearings should be kept to under 80% of this value. For bearings with 15° contact angle, this figure is applied to the high precision bearings ranked higher than class 5, used with machined cages or molded cages.

2) B, C or no indication after the bearing number indicates nominal contact angle of 40°, 15° and 30° respectively. [Remark] Standard cage types used for the above bearings are described earlier in this section.

Angular contact ball bearings (matched pair)

d (35) ~ (50) mm

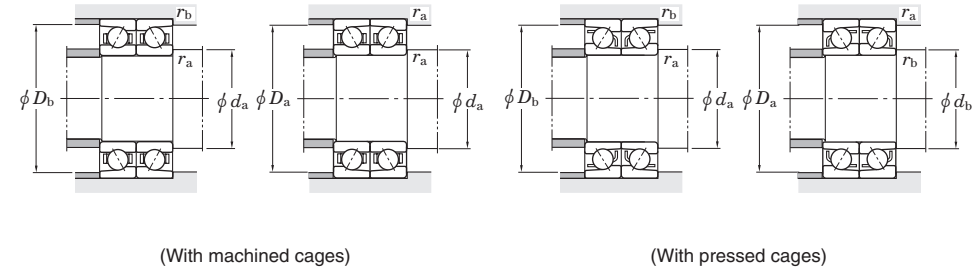
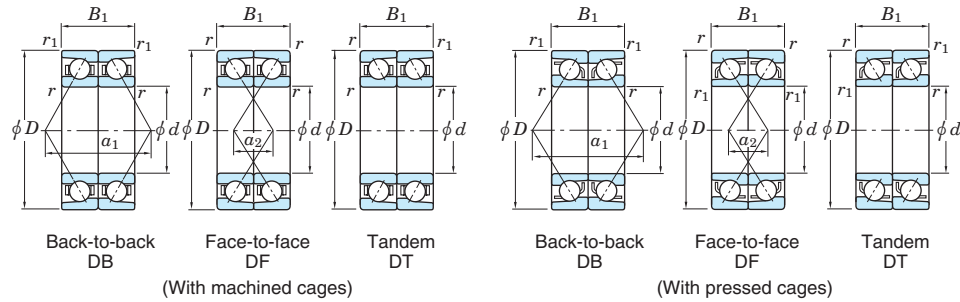

Boundary dimensions (mm)					Basic load ratings (kN)				Fatigue load limits (kN)		Factor	Limiting speeds ¹⁾ (min ⁻¹)		Bearing No. ²⁾			Load center spread (mm)		Mounting dimensions (mm)						(Refer.) Mass (kg)
d	D	B ₁	r _{min.}	r _{1 min.}	With machined cages		With pressed cages		C _u	f ₀	Grease lub.	Oil lub.	Back-to-back DB	Face-to-face DF	Tandem DT	a ₁	a ₂	d _{a min.}	d _{b min.}	D _{a max.}	D _{b max.}	r _{a max.}	r _{b max.}		
35	100	50	1.5	1	114	68.6	122	76.2	4.90	5.45	—	4 300	6 500	7407BDB	7407BDF	7407BDT	83.3	33.3	43.5	40.5	91.5	94.5	1.5	1	1.90
40	62	24	0.6	0.3	32.0	24.9	—	—	1.40	—	15.7	13 000	18 000	7908CDB	7908CDF	7908CDT	25.7	1.7	44.5	—	57.5	59.5	0.6	0.3	0.214
	68	30	1	0.6	38.1	29.2	—	—	1.65	—	—	8 900	11 000	7008DB	7008DF	7008DT	46.3	16.3	45.5	—	62.5	63.5	1	0.6	0.420
	68	30	1	0.6	34.2	26.4	—	—	1.45	—	—	6 600	8 900	7008BDB	7008BDF	7008BDT	60.5	30.5	45.5	—	62.5	63.5	1	0.6	0.420
	68	30	1	0.6	41.7	31.8	—	—	1.90	—	15.4	12 000	16 000	7008CDB	7008CDF	7008CDT	29.5	0.5	45.5	—	62.5	63.5	1	0.6	0.420
	80	36	1.1	0.6	68.2	46.7	71.7	50.3	3.00	3.25	—	8 000	10 000	7208DB	7208DF	7208DT	52.7	16.7	47	44.5	73	75.5	1	0.6	0.764
	80	36	1.1	0.6	62.1	42.7	65.2	45.9	2.60	2.80	—	6 000	8 000	7208BDB	7208BDF	7208BDT	68.3	32.3	47	44.5	73	75.5	1	0.6	0.764
	80	36	1.1	0.6	73.8	50.4	77.6	54.3	3.45	3.70	14.2	11 000	15 000	7208CDB	7208CDF	7208CDT	34.1	1.9	47	44.5	73	75.5	1	0.6	0.764
	90	46	1.5	1	87.8	54.9	99.1	65.9	3.85	4.60	—	7 400	9 200	7308DB	7308DF	7308DT	60.5	14.5	48.5	45.5	81.5	84.5	1.5	1	1.31
	90	46	1.5	1	80.6	50.5	91.0	60.6	3.30	3.95	—	5 500	7 400	7308BDB	7308BDF	7308BDT	77.5	31.5	48.5	45.5	81.5	84.5	1.5	1	1.31
	90	46	1.5	1	94.1	58.8	106	70.5	4.40	5.25	13.4	10 000	14 000	7308CDB	7308CDF	7308CDT	40.4	5.6	48.5	45.5	81.5	84.5	1.5	1	1.31
	110	54	2	1	142	87.1	152	96.8	6.70	7.45	—	4 600	6 600	7408DB	7408DF	7408DT	70.9	16.9	50	45.5	100	104.5	2	1	2.46
110	54	2	1	132	80.8	141	89.8	5.75	6.40	—	3 900	5 900	7408BDB	7408BDF	7408BDT	90.8	36.8	50	45.5	100	104.5	2	1	2.46	
45	68	24	0.6	0.3	33.7	28.2	—	—	1.55	—	16.0	12 000	16 000	7909CDB	7909CDF	7909CDT	27.1	3.1	49.5	—	63.5	65.5	0.6	0.3	0.254
	75	32	1	0.6	45.2	35.4	—	—	2.00	—	—	8 000	10 000	7009DB	7009DF	7009DT	50.7	18.7	50.5	—	69.5	70.5	1	0.6	0.520
	75	32	1	0.6	40.6	32.0	—	—	1.75	—	—	6 000	8 000	7009BDB	7009BDF	7009BDT	66.3	34.3	50.5	—	69.5	70.5	1	0.6	0.520
	75	32	1	0.6	49.6	38.5	—	—	2.25	—	15.4	11 000	15 000	7009CDB	7009CDF	7009CDT	32.1	0.1	50.5	—	69.5	70.5	1	0.6	0.520
	85	38	1.1	0.6	76.6	53.2	80.5	57.2	3.40	3.70	—	7 500	9 400	7209DB	7209DF	7209DT	56.0	18.0	52	49.5	78	80.5	1	0.6	0.860
	85	38	1.1	0.6	69.7	48.6	73.2	52.3	2.95	3.20	—	5 600	7 500	7209BDB	7209BDF	7209BDT	72.8	34.8	52	49.5	78	80.5	1	0.6	0.860
	85	38	1.1	0.6	82.9	57.4	87.1	61.8	3.90	4.20	14.2	10 000	14 000	7209CDB	7209CDF	7209CDT	36.2	1.8	52	49.5	78	80.5	1	0.6	0.860
	100	50	1.5	1	112	74.2	119	80.9	5.15	5.60	—	6 600	8 200	7309DB	7309DF	7309DT	67.2	17.2	53.5	50.5	91.5	94.5	1.5	1	1.75
	100	50	1.5	1	103	68.2	109	74.3	4.40	4.85	—	4 900	6 600	7309BDB	7309BDF	7309BDT	86.3	36.3	53.5	50.5	91.5	94.5	1.5	1	1.75
	100	50	1.5	1	120	79.5	127	86.7	5.85	6.40	13.5	9 000	12 000	7309CDB	7309CDF	7309CDT	44.6	5.4	53.5	50.5	91.5	94.5	1.5	1	1.75
	120	58	2	1	173	108	185	120	8.35	9.30	—	4 200	6 000	7409DB	7409DF	7409DT	77.2	19.2	55	50.5	110	114.5	2	1	3.10
	120	58	2	1	160	100	172	111	7.20	8.00	—	3 600	5 400	7409BDB	7409BDF	7409BDT	99.1	41.1	55	50.5	110	114.5	2	1	3.10
	50	72	24	0.6	0.3	35.4	31.4	—	—	1.70	—	16.2	11 000	15 000	7910CDB	7910CDF	7910CDT	28.3	4.3	54.5	—	67.5	69.5	0.6	0.3
80		32	1	0.6	48.0	40.2	—	—	2.20	—	—	7 300	9 200	7010DB	7010DF	7010DT	53.8	21.8	55.5	—	74.5	75.5	1	0.6	0.580

[Notes] 1) Limiting speeds shown above are applicable to machined cage bearings. Limiting speeds of pressed cage bearings should be kept to under 80% of this value. For bearings with 15° contact angle, this figure is applied to the high precision bearings ranked higher than class 5, used with machined cages or molded cages.

2) B, C or no indication after the bearing number indicates nominal contact angle of 40°, 15° and 30° respectively. [Remark] Standard cage types used for the above bearings are described earlier in this section.

Angular contact ball bearings (matched pair)

d (50) ~ (60) mm

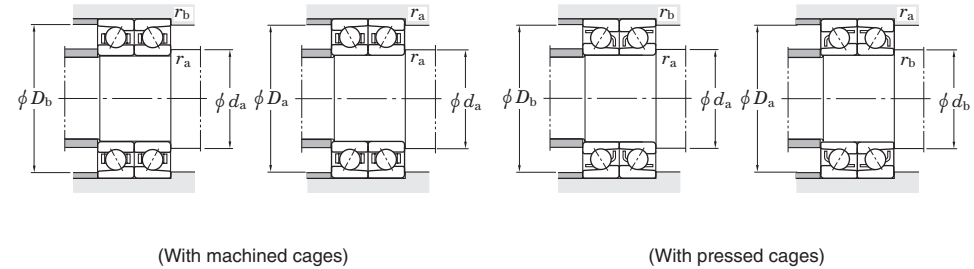
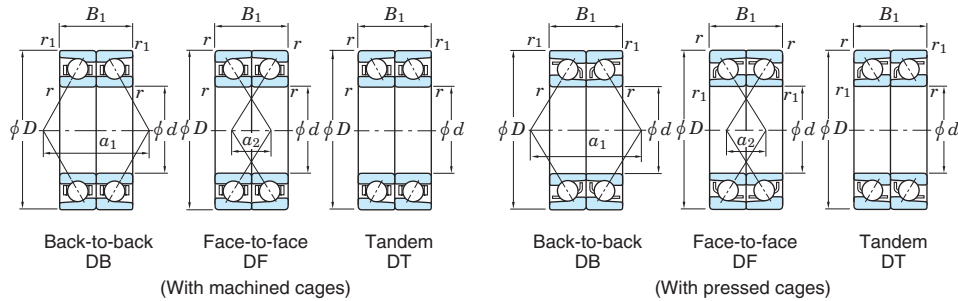

Boundary dimensions (mm)					Basic load ratings (kN)				Fatigue load limits (kN)		Factor	Limiting speeds ¹⁾ (min ⁻¹)		Bearing No. ²⁾			Load center spread (mm)		Mounting dimensions (mm)						(Refer.) Mass (kg)
d	D	B ₁	r _{min.}	r _{1 min.}	With machined cages		With pressed cages		C _u	f ₀	Grease lub.	Oil lub.	Back-to-back DB	Face-to-face DF	Tandem DT	a ₁	a ₂	d _{a min.}	d _{b min.}	D _{a max.}	D _{b max.}	r _{a max.}	r _{b max.}		
50	80	32	1	0.6	43.1	36.2	—	—	1.90	—	5 500	7 400	7010BDB	7010BDF	7010BDT	70.5	38.5	55.5	—	74.5	75.5	1	0.6	0.580	
	80	32	1	0.6	52.7	43.9	—	—	2.50	—	10 000	13 000	7010CDB	7010CDF	7010CDT	33.6	1.6	55.5	—	74.5	75.5	1	0.6	0.580	
	90	40	1.1	0.6	80.0	58.7	83.8	62.9	3.60	3.85	—	6 800	8 500	7210DB	7210DF	7210DT	60.7	20.7	57	54.5	83	85.5	1	0.6	0.970
	90	40	1.1	0.6	72.5	53.5	75.9	57.3	3.15	3.35	—	5 100	6 800	7210BDB	7210BDF	7210BDT	79.2	39.2	57	54.5	83	85.5	1	0.6	0.970
	90	40	1.1	0.6	86.9	63.6	91.0	68.1	4.10	4.40	14.6	9 400	12 000	7210CDB	7210CDF	7210CDT	38.9	1.1	57	54.5	83	85.5	1	0.6	0.970
	110	54	2	1	142	96.3	151	105	6.70	7.35	—	5 800	7 300	7310DB	7310DF	7310DT	74.4	20.4	60	55.5	100	104.5	2	1	2.28
	110	54	2	1	131	88.6	138	96.6	5.80	6.30	—	4 400	5 800	7310BDB	7310BDF	7310BDT	95.8	41.8	60	55.5	100	104.5	2	1	2.28
	110	54	2	1	153	103	162	112	7.70	8.40	13.4	8 000	11 000	7310CDB	7310CDF	7310CDT	49.0	5.0	60	55.5	100	104.5	2	1	2.28
	130	62	2.1	1.1	198	131	—	—	9.85	—	—	3 800	5 500	7410DB	7410DF	7410DT	83.3	21.3	62	—	118	123	2	1	3.84
	130	62	2.1	1.1	183	121	—	—	8.45	—	—	3 300	4 900	7410BDB	7410BDF	7410BDT	106.9	44.9	62	—	118	123	2	1	3.84
55	80	26	1	0.6	40.0	37.0	—	—	1.95	—	10 000	14 000	7911CDB	7911CDF	7911CDT	31.1	5.1	60.5	—	74.5	75.5	1	0.6	0.356	
	90	36	1.1	0.6	63.2	52.5	—	—	2.95	—	6 600	8 300	7011DB	7011DF	7011DT	59.9	23.9	62	—	83	85.5	1	0.6	0.840	
	90	36	1.1	0.6	56.7	47.5	—	—	2.55	—	5 000	6 600	7011BDB	7011BDF	7011BDT	78.8	42.8	62	—	83	85.5	1	0.6	0.840	
	90	36	1.1	0.6	69.3	57.3	—	—	3.35	—	9 100	12 000	7011CDB	7011CDF	7011CDT	37.4	1.4	62	—	83	85.5	1	0.6	0.840	
	100	42	1.5	1	98.9	74.2	104	79.6	4.60	4.90	—	6 100	7 600	7211DB	7211DF	7211DT	66.6	24.6	63.5	60.5	91.5	94.5	1.5	1	1.27
	100	42	1.5	1	89.6	67.6	93.8	72.4	3.95	4.25	—	4 600	6 100	7211BDB	7211BDF	7211BDT	87.3	45.3	63.5	60.5	91.5	94.5	1.5	1	1.27
	100	42	1.5	1	107	80.4	112	86.1	5.20	5.60	14.6	8 400	11 000	7211CDB	7211CDF	7211CDT	42.2	0.2	63.5	60.5	91.5	94.5	1.5	1	1.27
	120	58	2	1	164	113	174	123	7.90	8.60	—	5 400	6 700	7311DB	7311DF	7311DT	80.4	22.4	65	60.5	110	114.5	2	1	2.90
	120	58	2	1	151	104	160	113	6.80	7.40	—	4 000	5 400	7311BDB	7311BDF	7311BDT	103.7	45.7	65	60.5	110	114.5	2	1	2.90
	120	58	2	1	176	121	187	132	9.00	9.85	13.4	7 400	9 800	7311CDB	7311CDF	7311CDT	52.9	5.1	65	60.5	110	114.5	2	1	2.90
	140	66	2.1	1.1	241	165	—	—	12.8	—	—	3 500	5 000	7411DB	7411DF	7411DT	89.9	23.9	67	—	128	133	2	1	4.72
	140	66	2.1	1.1	224	153	—	—	11.0	—	—	3 000	4 500	7411BDB	7411BDF	7411BDT	115.7	49.7	67	—	128	133	2	1	4.72
60	85	26	1	0.6	47.2	43.6	—	—	2.35	—	9 100	13 000	7912CDB	7912CDF	7912CDT	32.6	6.6	65.5	—	79.5	80.5	1	0.6	0.374	
	95	36	1.1	0.6	64.8	56.1	—	—	3.10	—	6 200	7 700	7012DB	7012DF	7012DT	62.8	26.8	67	—	88	90.5	1	0.6	0.900	
	95	36	1.1	0.6	58.1	50.7	—	—	2.70	—	4 600	6 200	7012BDB	7012BDF	7012BDT	83.0	47.0	67	—	88	90.5	1	0.6	0.900	
	95	36	1.1	0.6	71.2	61.3	—	—	3.50	—	15.7	8 500	11 000	7012CDB	7012CDF	7012CDT	38.8	2.8	67	—	88	90.5	1	0.6	0.900
	110	44	1.5	1	120	91.5	125	98.0	5.65	6.05	—	5 500	6 900	7212DB	7212DF	7212DT	72.3	28.3	68.5	65.5	101.5	104.5	1.5	1	1.64

[Notes] 1) Limiting speeds shown above are applicable to machined cage bearings. Limiting speeds of pressed cage bearings should be kept to under 80% of this value. For bearings with 15° contact angle, this figure is applied to the high precision bearings ranked higher than class 5, used with machined cages or molded cages.

2) B, C or no indication after the bearing number indicates nominal contact angle of 40°, 15° and 30° respectively. [Remark] Standard cage types used for the above bearings are described earlier in this section.

Angular contact ball bearings (matched pair)

d (60) ~ (70) mm

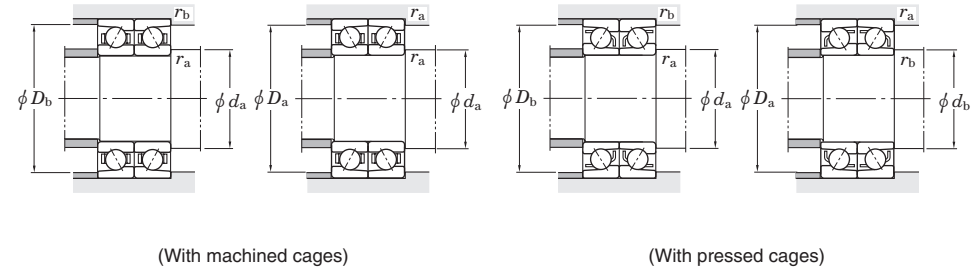
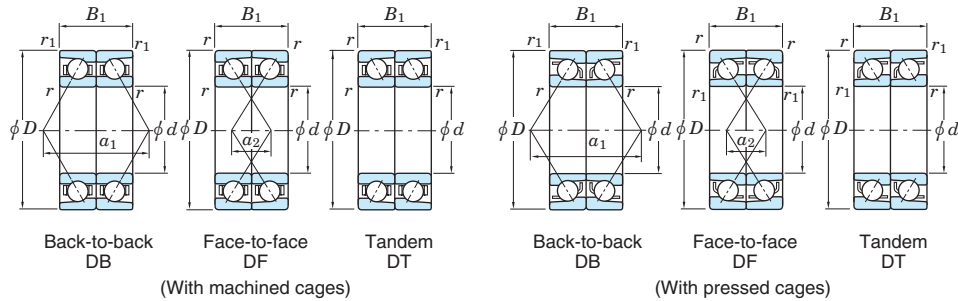

Boundary dimensions (mm)	Basic load ratings (kN)		Fatigue load limits (kN)		Factor	Limiting speeds ¹⁾		Bearing No. ²⁾			Load center spread (mm)		Mounting dimensions (mm)						(Refer.) Mass (kg)						
	d	D	B ₁	r _{min.}		r _{1 min.}	C _r	C _{0r}	C _r	C _{0r}	C _u	f ₀	Grease lub.	Oil lub.	Back-to-back DB	Face-to-face DF	Tandem DT	a ₁		a ₂	d _{a min.}	d _{b min.}	D _{a max.}	D _{b max.}	r _{a max.}
60	110	44	1.5	1	108	83.3	114	89.2	4.90	5.25	—	4 100	5 500	7212BDB	7212BDF	7212BDT	95.0	51.0	68.5	65.5	101.5	104.5	1.5	1	1.64
	110	44	1.5	1	130	99.0	136	106	6.45	6.90	14.5	7 500	10 000	7212CDB	7212CDF	7212CDT	45.3	1.3	68.5	65.5	101.5	104.5	1.5	1	1.64
	130	62	2.1	1.1	188	131	199	143	9.15	10.0	—	5 000	6 200	7312DB	7312DF	7312DT	86.5	24.5	72	67	118	123	2	1	3.62
	130	62	2.1	1.1	172	121	183	132	7.90	8.60	—	3 700	5 000	7312BDB	7312BDF	7312BDT	111.6	49.6	72	67	118	123	2	1	3.62
	130	62	2.1	1.1	201	141	213	153	10.5	11.4	13.4	6 800	9 100	7312CDB	7312CDF	7312CDT	56.7	5.3	72	67	118	123	2	1	3.62
	150	70	2.1	1.1	262	187	—	—	13.7	—	—	3 200	4 600	7412DB	7412DF	7412DT	97.0	27.0	72	—	138	143	2	1	5.70
	150	70	2.1	1.1	243	173	—	—	11.8	—	—	2 800	4 100	7412BDB	7412BDF	7412BDT	125.1	55.1	72	—	138	143	2	1	5.70
65	90	26	1	0.6	42.2	42.3	—	—	2.20	—	16.5	8 600	12 000	7913CDB	7913CDF	7913CDT	33.8	7.8	70.5	—	84.5	85.5	1	0.6	0.410
	100	36	1.1	0.6	68.3	62.8	—	—	3.40	—	—	5 800	7 200	7013DB	7013DF	7013DT	65.9	29.9	72	—	93	95.5	1	0.6	0.940
	100	36	1.1	0.6	61.2	56.6	—	—	2.95	—	—	4 300	5 800	7013BDB	7013BDF	7013BDT	87.6	51.6	72	—	93	95.5	1	0.6	0.940
	100	36	1.1	0.6	75.2	68.7	—	—	3.85	—	15.9	7 900	11 000	7013CDB	7013CDF	7013CDT	40.2	4.2	72	—	93	95.5	1	0.6	0.940
	120	46	1.5	1	137	108	143	116	6.65	7.10	—	5 200	6 400	7213DB	7213DF	7213DT	76.4	30.4	73.5	70.5	111.5	114.5	1.5	1	2.04
	120	46	1.5	1	124	98.7	129	105	5.80	6.15	—	3 900	5 200	7213BDB	7213BDF	7213BDT	100.6	54.6	73.5	70.5	111.5	114.5	1.5	1	2.04
	120	46	1.5	1	148	117	155	125	7.60	8.10	14.6	7 100	9 400	7213CDB	7213CDF	7213CDT	47.8	1.8	73.5	70.5	111.5	114.5	1.5	1	2.04
	140	66	2.1	1.1	213	151	225	164	10.3	11.3	—	4 600	5 800	7313DB	7313DF	7313DT	92.5	26.5	77	72	128	133	2	1	4.44
	140	66	2.1	1.1	195	139	207	151	8.90	9.70	—	3 500	4 600	7313BDB	7313BDF	7313BDT	119.4	53.4	77	72	128	133	2	1	4.44
	140	66	2.1	1.1	228	161	242	176	11.8	12.9	13.4	6 300	8 500	7313CDB	7313CDF	7313CDT	60.6	5.4	77	72	128	133	2	1	4.44
	160	74	2.1	1.1	282	209	—	—	14.8	—	—	3 000	4 300	7413DB	7413DF	7413DT	102.9	28.9	77	—	148	153	2	1	6.82
	160	74	2.1	1.1	262	194	—	—	12.7	—	—	2 600	3 900	7413BDB	7413BDF	7413BDT	132.7	58.7	77	—	148	153	2	1	6.82
	70	100	32	1	0.6	58.8	58.0	—	—	3.05	—	16.4	7 800	11 000	7914CDB	7914CDF	7914CDT	38.8	6.8	75.5	—	94.5	95.5	1	0.6
110		40	1.1	0.6	86.7	78.7	—	—	4.30	—	—	5 300	6 600	7014DB	7014DF	7014DT	72.0	32.0	77	—	103	105.5	1	0.6	1.32
110		40	1.1	0.6	77.7	71.1	—	—	3.75	—	—	4 000	5 300	7014BDB	7014BDF	7014BDT	95.5	55.5	77	—	103	105.5	1	0.6	1.32
110		40	1.1	0.6	95.3	86.0	—	—	4.90	—	15.7	7 300	9 700	7014CDB	7014CDF	7014CDT	44.1	4.1	77	—	103	105.5	1	0.6	1.32
125		48	1.5	1	142	111	155	127	6.85	7.80	—	4 900	6 100	7214DB	7214DF	7214DT	80.3	32.3	78.5	75.5	116.5	119.5	1.5	1	2.24
125		48	1.5	1	128	101	140	116	5.90	6.75	—	3 700	4 900	7214BDB	7214BDF	7214BDT	105.8	57.8	78.5	75.5	116.5	119.5	1.5	1	2.24
125		48	1.5	1	154	120	168	138	7.75	8.90	14.6	6 700	8 900	7214CDB	7214CDF	7214CDT	50.1	2.1	78.5	75.5	116.5	119.5	1.5	1	2.24
150		70	2.1	1.1	239	172	253	187	11.4	12.4	—	4 300	5 400	7314DB	7314DF	7314DT	98.5	28.5	82	77	138	143	2	1	5.40

[Notes] 1) Limiting speeds shown above are applicable to machined cage bearings. Limiting speeds of pressed cage bearings should be kept to under 80% of this value. For bearings with 15° contact angle, this figure is applied to the high precision bearings ranked higher than class 5, used with machined cages or molded cages.

2) B, C or no indication after the bearing number indicates nominal contact angle of 40°, 15° and 30° respectively. [Remark] Standard cage types used for the above bearings are described earlier in this section.

Angular contact ball bearings (matched pair)

d (70) ~ (80) mm

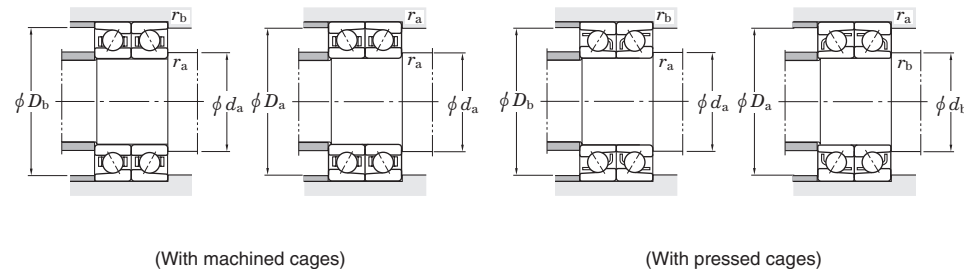
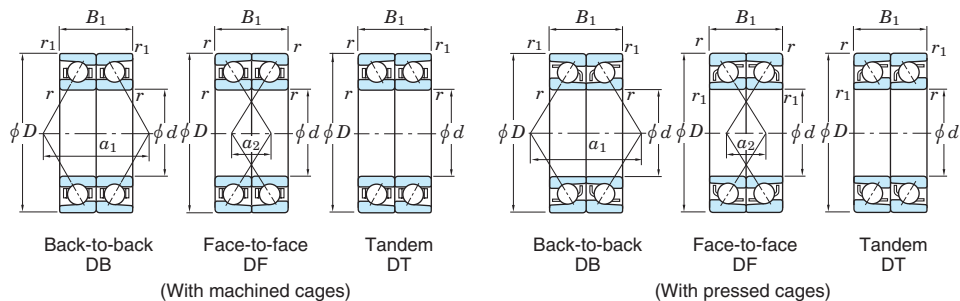

Boundary dimensions (mm)					Basic load ratings (kN)				Fatigue load limits (kN)		Factor	Limiting speeds ¹⁾ (min ⁻¹)		Bearing No. ²⁾			Load center spread (mm)		Mounting dimensions (mm)						(Refer.) Mass (kg)
d	D	B ₁	r _{min.}	r _{1 min.}	With machined cages		With pressed cages		C _u	f ₀	Grease lub.	Oil lub.	Back-to-back DB	Face-to-face DF	Tandem DT	a ₁	a ₂	d _{a min.}	d _{b min.}	D _{a max.}	D _{b max.}	r _{a max.}	r _{b max.}		
					C _r	C _{0r}	C _r	C _{0r}																	(With machined cages)
70	150	70	2.1	1.1	219	158	232	172	9.80	10.7	—	3 200	4 300	7314BDB	7314BDF	7314BDT	127.3	57.3	82	77	138	143	2	1	5.40
	150	70	2.1	1.1	256	184	272	200	13.0	14.2	13.4	5 900	7 900	7314CDB	7314CDF	7314CDT	64.5	5.5	82	77	138	143	2	1	5.40
	180	84	3	1.1	303	230	—	—	10.6	—	—	2 700	3 900	7414DB	7414DF	7414DT	115.3	31.3	84	—	166	173	2.5	1	9.98
	180	84	3	1.1	301	237	—	—	10.9	—	—	2 300	3 500	7414BDB	7414BDF	7414BDT	148.4	64.4	84	—	166	173	2.5	1	9.98
75	105	32	1	0.6	59.7	60.9	—	—	3.15	—	16.5	7 400	9 800	7915CDB	7915CDF	7915CDT	40.1	8.1	80.5	—	99.5	100.5	1	0.6	0.700
	115	40	1.1	0.6	88.6	83.4	—	—	4.50	—	—	5 000	6 300	7015DB	7015DF	7015DT	74.9	34.9	82	—	108	110.5	1	0.6	1.38
	115	40	1.1	0.6	79.3	75.2	—	—	3.95	—	—	3 800	5 000	7015BDB	7015BDF	7015BDT	99.7	59.7	82	—	108	110.5	1	0.6	1.38
	115	40	1.1	0.6	97.6	91.3	—	—	5.10	—	15.9	6 900	9 200	7015CDB	7015CDF	7015CDT	45.5	5.5	82	—	108	110.5	1	0.6	1.38
	130	50	1.5	1	161	130	168	139	7.90	8.40	—	4 600	5 800	7215DB	7215DF	7215DT	84.2	34.2	83.5	80.5	121.5	124.5	1.5	1	2.46
	130	50	1.5	1	146	119	152	127	6.85	7.30	—	3 500	4 600	7215BDB	7215BDF	7215BDT	111.0	61.0	83.5	80.5	121.5	124.5	1.5	1	2.46
	130	50	1.5	1	175	141	183	151	8.95	9.55	14.6	6 400	8 500	7215CDB	7215CDF	7215CDT	52.5	2.5	83.5	80.5	121.5	124.5	1.5	1	2.46
	160	74	2.1	1.1	260	194	276	212	12.4	13.5	—	4 000	5 000	7315DB	7315DF	7315DT	104.9	30.9	87	82	148	153	2	1	6.30
	160	74	2.1	1.1	239	178	253	195	10.7	11.7	—	3 000	4 000	7315BDB	7315BDF	7315BDT	135.6	61.6	87	82	148	153	2	1	6.30
	160	74	2.1	1.1	279	208	296	227	14.2	15.5	13.4	5 500	7 400	7315CDB	7315CDF	7315CDT	68.5	5.5	87	82	148	153	2	1	6.30
	190	90	3	1.1	348	282	—	—	12.6	—	—	2 500	3 600	7415DB	7415DF	7415DT	122.7	32.7	89	—	176	183	2.5	1	11.8
	190	90	3	1.1	322	261	—	—	11.6	—	—	2 200	3 300	7415BDB	7415BDF	7415BDT	157.9	67.9	89	—	176	183	2.5	1	11.8
80	110	32	1	0.6	60.5	63.2	—	—	3.25	—	16.5	7 000	9 300	7916CDB	7916CDF	7916CDT	41.5	9.5	85.5	—	104.5	105.5	1	0.6	0.736
	125	44	1.1	0.6	108	101	—	—	5.50	—	—	4 600	5 800	7016DB	7016DF	7016DT	81.2	37.2	87	—	118	120.5	1	0.6	1.86
	125	44	1.1	0.6	97.1	91.3	—	—	4.75	—	—	3 500	4 600	7016BDB	7016BDF	7016BDT	108.0	64.0	87	—	118	120.5	1	0.6	1.86
	125	44	1.1	0.6	119	111	—	—	6.20	—	15.7	6 400	8 500	7016CDB	7016CDF	7016CDT	49.5	5.5	87	—	118	120.5	1	0.6	1.86
	140	52	2	1	173	143	181	152	8.25	8.80	—	4 300	5 400	7216DB	7216DF	7216DT	89.5	37.5	90	85.5	130	134.5	2	1	3.00
	140	52	2	1	157	130	163	139	7.15	7.60	—	3 200	4 300	7216BDB	7216BDF	7216BDT	118.3	66.3	90	85.5	130	134.5	2	1	3.00
	140	52	2	1	189	155	197	165	9.40	10.0	14.7	5 900	7 900	7216CDB	7216CDF	7216CDT	55.5	3.5	90	85.5	130	134.5	2	1	3.00
	170	78	2.1	1.1	282	218	299	238	13.5	14.7	—	3 800	4 700	7316DB	7316DF	7316DT	111.2	33.2	92	87	158	163	2	1	7.70
	170	78	2.1	1.1	259	200	274	218	11.6	12.7	—	2 800	3 800	7316BDB	7316BDF	7316BDT	143.9	65.9	92	87	158	163	2	1	7.70
	170	78	2.1	1.1	302	233	321	255	15.4	16.8	13.5	5 200	6 900	7316CDB	7316CDF	7316CDT	72.5	5.5	92	87	158	163	2	1	7.70
	200	96	3	1.1	391	332	—	—	14.4	—	—	2 400	3 400	7416DB	7416DF	7416DT	130.0	34.0	94	—	186	193	2.5	1	12.0

[Notes] 1) Limiting speeds shown above are applicable to machined cage bearings. Limiting speeds of pressed cage bearings should be kept to under 80% of this value. For bearings with 15° contact angle, this figure is applied to the high precision bearings ranked higher than class 5, used with machined cages or molded cages.

2) B, C or no indication after the bearing number indicates nominal contact angle of 40°, 15° and 30° respectively. [Remark] Standard cage types used for the above bearings are described earlier in this section.

Angular contact ball bearings (matched pair)

d (80) ~ (95) mm

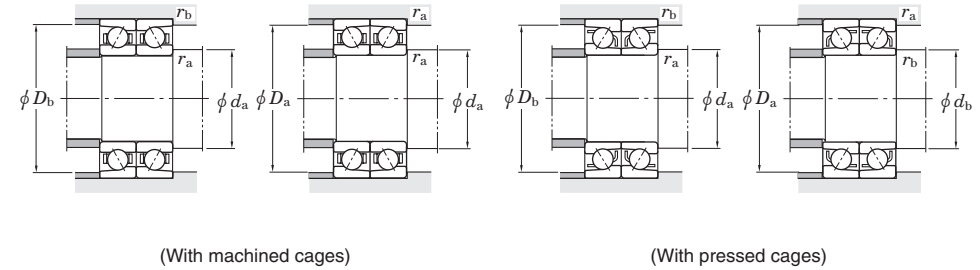
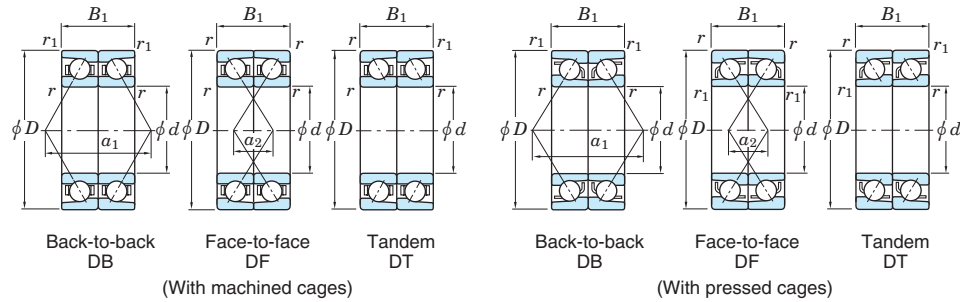

Boundary dimensions (mm)					Basic load ratings (kN)				Fatigue load limits (kN)		Factor	Limiting speeds ¹⁾ (min ⁻¹)		Bearing No. ²⁾			Load center spread (mm)		Mounting dimensions (mm)						(Refer.) Mass (kg)
d	D	B ₁	r _{min.}	r _{1 min.}	With machined cages		With pressed cages		C _u	f ₀	Grease lub.	Oil lub.	Back-to-back DB	Face-to-face DF	Tandem DT	a ₁	a ₂	d _{a min.}	d _{b min.}	D _{a max.}	D _{b max.}	r _{a max.}	r _{b max.}		
80	200	96	3	1.1	363	307	—	—	13.3	—	—	2 100	3 100	7416BDB	7416BDF	7416BDT	167.2	71.2	94	—	186	193	2.5	1	12.0
85	120	36	1.1	0.6	79.0	81.3	—	—	4.20	—	16.5	6 500	8 600	7917CDB	7917CDF	7917CDT	45.5	9.5	92	—	113	115.5	1	0.6	1.05
	130	44	1.1	0.6	111	107	—	—	5.55	—	—	4 400	5 500	7017DB	7017DF	7017DT	84.7	40.7	92	—	123	125.5	1	0.6	1.94
	130	44	1.1	0.6	99.2	96.7	—	—	4.85	—	—	3 300	4 400	7017BDB	7017BDF	7017BDT	113.0	69.0	92	—	123	125.5	1	0.6	1.94
	130	44	1.1	0.6	122	117	—	—	6.30	—	15.9	6 000	8 000	7017CDB	7017CDF	7017CDT	51.1	7.1	92	—	123	125.5	1	0.6	1.94
	150	56	2	1	200	167	209	178	9.40	10.0	—	4 000	5 000	7217DB	7217DF	7217DT	95.9	39.9	95	90.5	140	144.5	2	1	3.74
	150	56	2	1	181	152	189	162	8.15	8.70	—	3 000	4 000	7217BDB	7217BDF	7217BDT	126.6	70.6	95	90.5	140	144.5	2	1	3.74
	150	56	2	1	218	181	227	193	10.7	11.4	14.7	5 500	7 400	7217CDB	7217CDF	7217CDT	59.5	3.5	95	90.5	140	144.5	2	1	3.74
	180	82	3	1.1	304	243	322	265	14.6	15.9	—	3 500	4 400	7317DB	7317DF	7317DT	117.5	35.5	99	92	166	173	2.5	1	9.06
	180	82	3	1.1	279	223	295	244	12.6	13.7	—	2 700	3 500	7317BDB	7317BDF	7317BDT	152.2	70.2	99	92	166	173	2.5	1	9.06
	180	82	3	1.1	326	261	346	284	16.7	18.2	13.5	4 900	6 500	7317CDB	7317CDF	7317CDT	76.5	5.5	99	92	166	173	2.5	1	9.06
	210	104	4	1.5	414	360	—	—	15.3	—	—	2 300	3 300	7417DB	7417DF	7417DT	137.5	33.5	103	—	192	201.5	3	1.5	17.1
	210	104	4	1.5	384	334	—	—	14.2	—	—	2 000	3 000	7417BDB	7417BDF	7417BDT	176.2	72.2	103	—	192	201.5	3	1.5	17.1
90	125	36	1.1	0.6	80.3	85.2	—	—	4.25	—	16.6	6 200	8 200	7918CDB	7918CDF	7918CDT	46.8	10.8	97	—	118	120.5	1	0.6	1.10
	140	48	1.5	1	132	127	—	—	6.45	—	—	4 100	5 100	7018DB	7018DF	7018DT	90.4	42.4	98.5	—	131.5	134.5	1.5	1	2.52
	140	48	1.5	1	119	114	—	—	5.60	—	—	3 100	4 100	7018BDB	7018BDF	7018BDT	120.5	72.5	98.5	—	131.5	134.5	1.5	1	2.52
	140	48	1.5	1	146	138	—	—	7.30	—	15.7	5 700	7 500	7018CDB	7018CDF	7018CDT	54.8	6.8	98.5	—	131.5	134.5	1.5	1	2.52
	160	60	2	1	229	193	239	206	10.6	11.3	—	3 800	4 700	7218DB	7218DF	7218DT	102.2	42.2	100	95.5	150	154.5	2	1	4.60
	160	60	2	1	207	176	217	188	9.15	9.80	—	2 800	3 800	7218BDB	7218BDF	7218BDT	134.9	74.9	100	95.5	150	154.5	2	1	4.60
	160	60	2	1	249	209	260	223	12.0	12.8	14.6	5 200	6 900	7218CDB	7218CDF	7218CDT	63.5	3.5	100	95.5	150	154.5	2	1	4.60
	190	86	3	1.1	327	270	346	294	11.8	12.8	—	3 300	4 200	7318DB	7318DF	7318DT	123.9	37.9	104	97	176	183	2.5	1	10.6
	190	86	3	1.1	300	248	317	270	10.8	11.8	—	2 500	3 300	7318BDB	7318BDF	7318BDT	160.5	74.5	104	97	176	183	2.5	1	10.6
	190	86	3	1.1	351	289	372	315	12.6	13.8	13.5	4 600	6 100	7318CDB	7318CDF	7318CDT	80.5	5.5	104	97	176	183	2.5	1	10.6
	225	108	4	1.5	439	393	—	—	16.2	—	—	2 100	3 100	7418DB	7418DF	7418DT	145.0	37.0	108	—	207	216.5	3	1.5	22.8
	225	108	4	1.5	406	364	—	—	15.0	—	—	1 800	2 800	7418BDB	7418BDF	7418BDT	186.2	78.2	108	—	207	216.5	3	1.5	22.8
95	130	36	1.1	0.6	81.6	88.3	—	—	4.30	—	16.5	5 900	7 900	7919CDB	7919CDF	7919CDT	48.1	12.1	102	—	123	125.5	1	0.6	1.15
	145	48	1.5	1	135	134	—	—	6.55	—	—	3 900	4 800	7019DB	7019DF	7019DT	94.5	46.5	103.5	—	136.5	139.5	1.5	1	2.64

[Notes] 1) Limiting speeds shown above are applicable to machined cage bearings. Limiting speeds of pressed cage bearings should be kept to under 80% of this value. For bearings with 15° contact angle, this figure is applied to the high precision bearings ranked higher than class 5, used with machined cages or molded cages.

2) B, C or no indication after the bearing number indicates nominal contact angle of 40°, 15° and 30° respectively. [Remark] Standard cage types used for the above bearings are described earlier in this section.

Angular contact ball bearings (matched pair)

d (95) ~ (105) mm

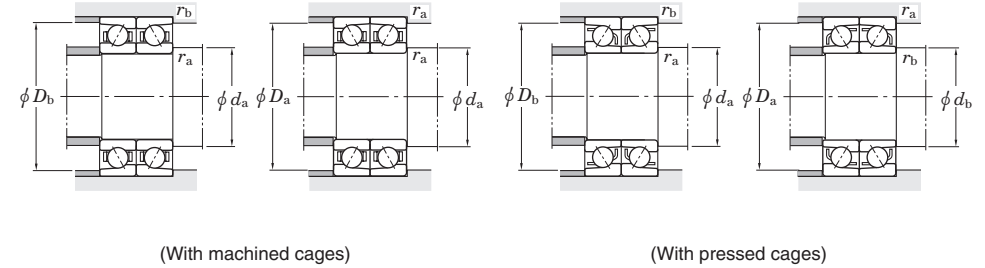
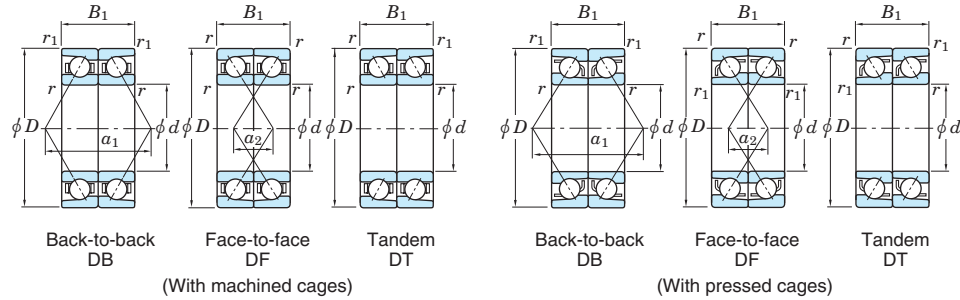

Boundary dimensions (mm)					Basic load ratings (kN)				Fatigue load limits (kN)		Factor f_0	Limiting speeds ¹⁾ (min ⁻¹)		Bearing No. ²⁾			Load center spread (mm)		Mounting dimensions (mm)						(Refer.) Mass (kg)		
d	D	B ₁	r min.	r ₁ min.	With machined cages		With pressed cages		C _u	C _{0r}		C _r	C _{0r}	Grease lub.	Oil lub.	Back-to-back DB	Face-to-face DF	Tandem DT	a ₁	a ₂	d _a min.	d _b min.	D _a max.	D _b max.		r _a max.	r _b max.
95	145	48	1.5	1	121	121	—	—	5.70	—	—	—	2 900	3 900	7019BDB	7019BDF	7019BDT	126.4	78.4	103.5	—	136.5	139.5	1.5	1	2.64	
	145	48	1.5	1	149	147	—	—	7.40	—	—	15.9	5 300	7 100	7019CDB	7019CDF	7019CDT	56.7	8.7	103.5	—	136.5	139.5	1.5	1	2.64	
	170	64	2.1	1.1	248	207	260	221	11.0	11.8	—	—	3 500	4 400	7219DB	7219DF	7219DT	108.5	44.5	107	102	158	163	2	1	5.56	
	170	64	2.1	1.1	224	188	235	201	9.55	10.2	—	—	2 700	3 500	7219BDB	7219BDF	7219BDT	143.2	79.2	107	102	158	163	2	1	5.56	
	170	64	2.1	1.1	269	224	282	240	12.6	13.5	14.6	—	4 900	6 500	7219CDB	7219CDF	7219CDT	67.5	3.5	107	102	158	163	2	1	5.56	
	200	90	3	1.1	350	298	371	325	12.7	13.8	—	—	3 200	4 000	7319DB	7319DF	7319DT	130.2	40.2	109	102	186	193	2.5	1	12.2	
	200	90	3	1.1	321	273	340	298	11.6	12.7	—	—	2 400	3 200	7319BDB	7319BDF	7319BDT	168.8	78.8	109	102	186	193	2.5	1	12.2	
	200	90	3	1.1	376	319	398	348	13.6	14.8	13.5	—	4 400	5 800	7319CDB	7319CDF	7319CDT	84.5	5.5	109	102	186	193	2.5	1	12.2	
100	140	40	1.1	0.6	113	117	—	—	5.65	—	16.3	—	5 500	7 400	7920CDB	7920CDF	7920CDT	52.1	12.1	107	—	133	135.5	1	0.6	1.55	
	150	48	1.5	1	139	141	—	—	6.75	—	—	—	3 800	4 700	7020DB	7020DF	7020DT	96.2	48.2	108.5	—	141.5	144.5	1.5	1	2.74	
	150	48	1.5	1	124	127	—	—	5.90	—	—	—	2 800	3 800	7020BDB	7020BDF	7020BDT	128.9	80.9	108.5	—	141.5	144.5	1.5	1	2.74	
	150	48	1.5	1	153	154	—	—	7.65	—	16.0	—	5 200	6 900	7020CDB	7020CDF	7020CDT	57.5	9.5	108.5	—	141.5	144.5	1.5	1	2.74	
	180	68	2.1	1.1	279	235	292	252	12.2	13.0	—	—	3 300	4 100	7220DB	7220DF	7220DT	115.4	47.4	112	—	168	173	2	1	6.64	
	180	68	2.1	1.1	252	214	264	229	10.5	11.3	—	—	2 500	3 300	7220BDB	7220BDF	7220BDT	152.3	84.3	112	—	168	173	2	1	6.64	
	180	68	2.1	1.1	303	254	317	273	13.9	14.8	14.6	—	4 600	6 100	7220CDB	7220CDF	7220CDT	71.8	3.8	112	107	168	173	2	1	6.64	
	215	94	3	1.1	373	323	421	387	13.2	15.9	—	—	2 900	3 600	7320DB	7320DF	7320DT	138.8	44.8	114	—	201	208	2.5	1	15.1	
	215	94	3	1.1	342	297	386	356	12.2	14.6	—	—	2 200	2 900	7320BDB	7320BDF	7320BDT	180.4	86.4	114	—	201	208	2.5	1	15.1	
	215	94	3	1.1	400	346	451	415	14.2	17.0	13.4	—	4 000	5 300	7320CDB	7320CDF	7320CDT	89.6	4.4	114	107	201	208	2.5	1	15.1	
	105	145	40	1.1	0.6	115	123	—	—	5.75	—	16.4	—	5 300	7 100	7921CDB	7921CDF	7921CDT	53.5	13.5	112	—	138	140.5	1	0.6	1.62
		160	52	2	1	162	164	—	—	7.60	—	—	—	3 500	4 400	7021DB	7021DF	7021DT	103.7	51.7	115	—	150	154.5	2	1	3.46
160		52	2	1	145	148	—	—	6.65	—	—	—	2 600	3 500	7021BDB	7021BDF	7021BDT	137.2	85.2	115	—	150	154.5	2	1	3.46	
160		52	2	1	178	179	—	—	8.60	—	15.9	—	4 800	6 400	7021CDB	7021CDF	7021CDT	62.0	10.0	115	—	150	154.5	2	1	3.46	
190		72	2.1	1.1	303	265	—	—	13.4	—	—	—	3 100	3 900	7221DB	7221DF	7221DT	122.1	50.1	117	—	178	183	2	1	7.90	
190		72	2.1	1.1	275	241	—	—	11.6	—	—	—	2 300	3 100	7221BDB	7221BDF	7221BDT	161.0	89.0	117	—	178	183	2	1	7.90	
190		72	2.1	1.1	330	287	—	—	15.2	—	14.6	—	4 300	5 700	7221CDB	7221CDF	7221CDT	75.9	3.9	117	—	178	183	2	1	7.90	
225		98	3	1.1	422	386	—	—	15.5	—	—	—	2 800	3 500	7321DB	7321DF	7321DT	144.3	46.3	119	—	211	218	2.5	1	17.2	
225		98	3	1.1	387	355	—	—	14.3	—	—	—	2 100	2 800	7321BDB	7321BDF	7321BDT	187.5	89.5	119	—	211	218	2.5	1	17.2	

[Notes] 1) Limiting speeds shown above are applicable to machined cage bearings. Limiting speeds of pressed cage bearings should be kept to under 80% of this value. For bearings with 15° contact angle, this figure is applied to the high precision bearings ranked higher than class 5, used with machined cages or molded cages.

2) B, C or no indication after the bearing number indicates nominal contact angle of 40°, 15° and 30° respectively. [Remark] Standard cage types used for the above bearings are described earlier in this section.

Angular contact ball bearings (matched pair)

d (105) ~ (130) mm

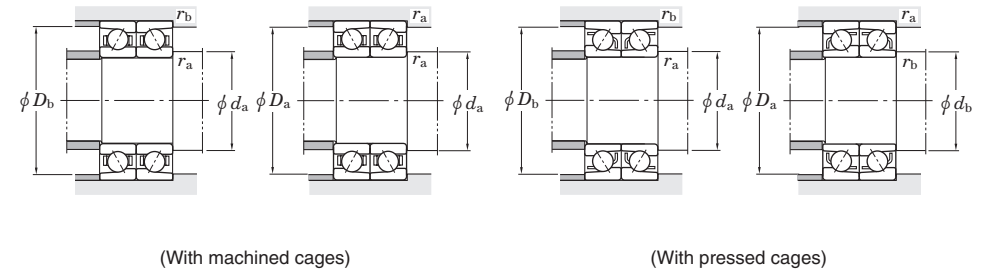
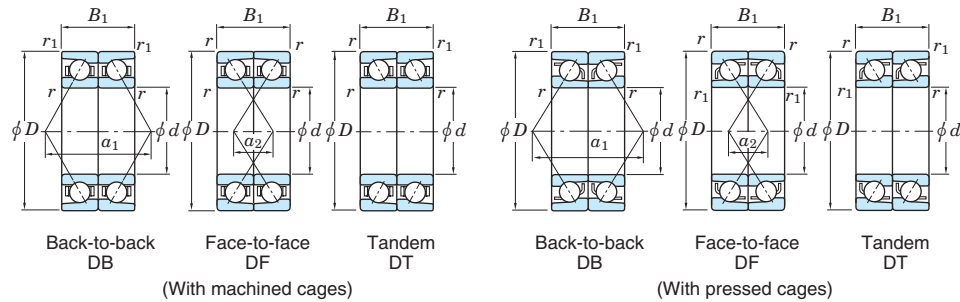

Boundary dimensions (mm)					Basic load ratings (kN)				Fatigue load limits (kN)		Factor	Limiting speeds ¹⁾ (min ⁻¹)		Bearing No. ²⁾			Load center spread (mm)		Mounting dimensions (mm)						(Refer.) Mass (kg)
d	D	B ₁	r _{min.}	r _{1 min.}	With machined cages		With pressed cages		C _u	f ₀	Grease lub.	Oil lub.	Back-to-back DB	Face-to-face DF	Tandem DT	a ₁	a ₂	d _{a min.}	d _{b min.}	D _{a max.}	D _{b max.}	r _{a max.}	r _{b max.}		
					C _r	C _{0r}	C _r	C _{0r}																	(With machined cages)
105	225	98	3	1.1	452	413	—	—	16.6	—	13.4	3 900	5 100	7321CDB	7321CDF	7321CDT	93.2	4.8	119	—	211	218	2.5	1	17.2
110	150	40	1.1	0.6	117	129	—	—	5.85	—	16.5	5 100	6 800	7922CDB	7922CDF	7922CDT	54.8	14.8	117	—	143	145.5	1	0.6	1.68
	170	56	2	1	187	186	—	—	8.55	—	—	3 300	4 200	7022DB	7022DF	7022DT	108.9	52.9	120	—	160	164.5	2	1	4.28
	170	56	2	1	167	167	—	—	7.45	—	—	2 500	3 300	7022BDB	7022BDF	7022BDT	145.5	89.5	120	—	160	164.5	2	1	4.28
	170	56	2	1	205	203	—	—	9.70	—	15.7	4 600	6 100	7022CDB	7022CDF	7022CDT	65.5	9.5	120	—	160	164.5	2	1	4.28
	200	76	2.1	1.1	329	297	—	—	14.6	—	—	3 000	3 700	7222DB	7222DF	7222DT	128.7	52.7	122	—	188	193	2	1	9.30
	200	76	2.1	1.1	298	270	—	—	12.7	—	—	2 200	3 000	7222BDB	7222BDF	7222BDT	169.7	93.7	122	—	188	193	2	1	9.30
	200	76	2.1	1.1	357	321	—	—	16.7	—	14.5	4 100	5 400	7222CDB	7222CDF	7222CDT	80.1	4.1	122	—	188	193	2	1	9.30
	240	100	3	1.1	472	452	—	—	17.5	—	—	2 600	3 200	7322DB	7322DF	7322DT	152.7	52.7	124	—	226	233	2.5	1	20.2
	240	100	3	1.1	433	416	—	—	16.1	—	—	1 900	2 600	7322BDB	7322BDF	7322BDT	199.3	99.3	124	—	226	233	2.5	1	20.2
	240	100	3	1.1	505	484	—	—	18.8	—	13.4	3 500	4 700	7322CDB	7322CDF	7322CDT	97.7	2.3	124	—	226	233	2.5	1	20.2
120	165	44	1.1	0.6	146	162	—	—	7.10	—	16.5	4 700	6 200	7924CDB	7924CDF	7924CDT	60.2	16.2	127	—	158	160.5	1	0.6	2.30
	180	56	2	1	196	206	—	—	9.00	—	—	3 100	3 900	7024DB	7024DF	7024DT	114.6	58.6	130	—	170	174.5	2	1	4.54
	180	56	2	1	176	186	—	—	7.85	—	—	2 300	3 100	7024BDB	7024BDF	7024BDT	153.9	97.9	130	—	170	174.5	2	1	4.54
	180	56	2	1	216	226	—	—	10.2	—	16.0	4 300	5 700	7024CDB	7024CDF	7024CDT	68.2	12.2	130	—	170	174.5	2	1	4.54
	215	80	2.1	1.1	354	332	—	—	15.7	—	—	2 700	3 400	7224DB	7224DF	7224DT	137.0	57.0	132	—	203	208	2	1	11.0
	215	80	2.1	1.1	321	302	—	—	13.6	—	—	2 100	2 800	7224BDB	7224BDF	7224BDT	180.5	100.5	132	—	203	208	2	1	11.0
	215	80	2.1	1.1	385	359	—	—	17.9	—	14.6	3 800	5 000	7224CDB	7224CDF	7224CDT	85.0	5.0	132	—	203	208	2	1	11.0
	260	110	3	1.1	500	504	—	—	18.9	—	—	2 400	3 000	7324DB	7324DF	7324DT	164.7	54.7	134	—	246	253	2.5	1	25.2
	260	110	3	1.1	457	462	—	—	17.3	—	—	1 800	2 400	7324BDB	7324BDF	7324BDT	214.4	104.4	134	—	246	253	2.5	1	25.2
	260	110	3	1.1	538	542	—	—	20.3	—	13.7	3 300	4 400	7324CDB	7324CDF	7324CDT	105.9	4.1	134	—	246	253	2.5	1	25.2
130	180	48	1.5	1	177	200	—	—	8.45	—	16.4	4 300	5 700	7926CDB	7926CDF	7926CDT	65.5	17.5	138.5	—	171.5	174.5	1.5	1	3.00
	200	66	2	1	238	251	—	—	10.5	—	—	2 800	3 500	7026DB	7026DF	7026DT	128.3	62.3	140	—	190	194.5	2	1	6.86
	200	66	2	1	213	226	—	—	9.20	—	—	2 100	2 800	7026BDB	7026BDF	7026BDT	171.5	105.5	140	—	190	194.5	2	1	6.86
	200	66	2	1	262	274	—	—	11.9	—	15.9	3 900	5 100	7026CDB	7026CDF	7026CDT	77.2	11.2	140	—	190	194.5	2	1	6.86
	230	80	3	1.1	398	395	—	—	15.2	—	—	2 500	3 200	7226DB	7226DF	7226DT	143.9	63.9	144	—	216	223	2.5	1	12.4

[Notes] 1) Limiting speeds shown above are applicable to machined cage bearings. Limiting speeds of pressed cage bearings should be kept to under 80% of this value. For bearings with 15° contact angle, this figure is applied to the high precision bearings ranked higher than class 5, used with machined cages or molded cages.

2) B, C or no indication after the bearing number indicates nominal contact angle of 40°, 15° and 30° respectively. [Remark] Standard cage types used for the above bearings are described earlier in this section.

Angular contact ball bearings (matched pair)

d (130) ~ (160) mm

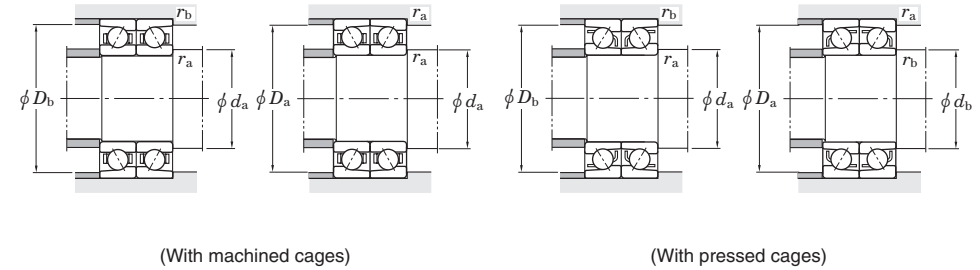
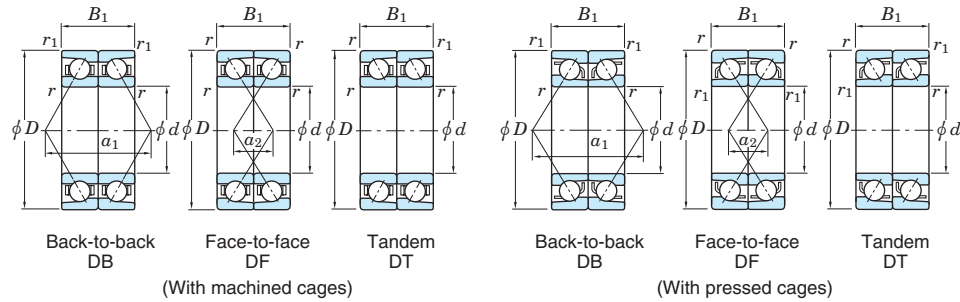

Boundary dimensions (mm)					Basic load ratings (kN)				Fatigue load limits (kN)		Factor	Limiting speeds ¹⁾ (min ⁻¹)		Bearing No. ²⁾			Load center spread (mm)		Mounting dimensions (mm)						(Refer.) Mass (kg)	
d	D	B ₁	r _{min.}	r _{1 min.}	With machined cages		With pressed cages		C _u	f ₀	Grease lub.	Oil lub.	Back-to-back DB	Face-to-face DF	Tandem DT	a ₁	a ₂	d _{a min.}	d _{b min.}	D _{a max.}	D _{b max.}	r _{a max.}	r _{b max.}			
					C _r	C _{0r}	C _r	C _{0r}																	(With machined cages)	(With pressed cages)
130	230	80	3	1.1	360	360	—	—	13.9	—	—	1 900	2 500	7226BDB	7226BDF	7226BDT	191.0	111.0	144	—	216	223	2.5	1	12.4	
	230	80	3	1.1	433	428	—	—	16.5	—	14.7	3 500	4 700	7226CDB	7226CDF	7226CDT	88.2	8.2	144	—	216	223	2.5	1	12.4	
	280	116	4	1.5	611	659	—	—	23.7	—	—	2 200	2 700	7326DB	7326DF	7326DT	177.5	61.5	148	—	262	271.5	3	1.5	30.8	
	280	116	4	1.5	507	536	—	—	19.4	—	—	1 600	2 200	7326BDB	7326BDF	7326BDT	230.0	114.0	148	—	262	271.5	3	1.5	30.8	
	280	116	4	1.5	597	629	—	—	22.7	—	13.7	3 000	4 000	7326CDB	7326CDF	7326CDT	112.9	3.1	148	—	262	271.5	3	1.5	30.8	
	140	190	48	1.5	1	179	210	—	—	8.45	—	16.6	4 000	5 400	7928CDB	7928CDF	7928CDT	68.2	20.2	148.5	—	181.5	184.5	1.5	1	3.18
210		66	2	1	243	265	—	—	10.6	—	—	2 600	3 300	7028DB	7028DF	7028DT	134.1	68.1	150	—	200	204.5	2	1	7.28	
210		66	2	1	217	237	—	—	9.25	—	—	2 000	2 600	7028BDB	7028BDF	7028BDT	179.8	113.8	150	—	200	204.5	2	1	7.28	
210		66	2	1	268	290	—	—	12.0	—	16.0	3 600	4 800	7028CDB	7028CDF	7028CDT	79.9	13.9	150	—	200	204.5	2	1	7.28	
250		84	3	1.1	443	468	—	—	17.3	—	—	2 300	2 900	7228DB	7228DF	7228DT	154.6	70.6	154	—	236	243	2.5	1	15.5	
250		84	3	1.1	401	426	—	—	15.7	—	—	1 700	2 300	7228BDB	7228BDF	7228BDT	205.6	121.6	154	—	236	243	2.5	1	15.5	
250		84	3	1.1	483	508	—	—	18.8	—	14.8	3 200	4 300	7228CDB	7228CDF	7228CDT	94.2	10.2	154	—	236	243	2.5	1	15.5	
300		124	4	1.5	668	748	—	—	26.1	—	—	2 000	2 500	7328DB	7328DF	7328DT	189.0	65.0	158	—	282	291.5	3	1.5	37.6	
300		124	4	1.5	613	688	—	—	24.0	—	—	1 500	2 000	7328BDB	7328BDF	7328BDT	246.6	122.6	158	—	282	291.5	3	1.5	37.6	
300		124	4	1.5	717	802	—	—	27.9	—	13.4	2 800	3 700	7328CDB	7328CDF	7328CDT	120.9	3.1	158	—	282	291.5	3	1.5	37.6	
150		210	56	2	1	241	263	—	—	10.9	—	16.3	3 700	4 900	7930CDB	7930CDF	7930CDT	76.2	20.2	160	—	200	204.5	2	1	4.94
		225	70	2.1	1.1	278	308	—	—	11.9	—	—	2 400	3 000	7030DB	7030DF	7030DT	144.2	74.2	162	—	213	218	2	1	8.86
	225	70	2.1	1.1	249	275	—	—	10.4	—	—	1 800	2 400	7030BDB	7030BDF	7030BDT	192.3	122.3	162	—	213	218	2	1	8.86	
	225	70	2.1	1.1	306	337	—	—	13.4	—	16.1	3 300	4 400	7030CDB	7030CDF	7030CDT	85.6	15.6	162	—	213	218	2	1	8.86	
	270	90	3	1.1	504	560	—	—	19.9	—	—	2 100	2 700	7230DB	7230DF	7230DT	166.3	76.3	164	—	256	263	2.5	1	19.5	
	270	90	3	1.1	456	509	—	—	18.1	—	—	1 600	2 100	7230BDB	7230BDF	7230BDT	221.2	131.2	164	—	256	263	2.5	1	19.5	
	270	90	3	1.1	549	607	—	—	21.6	—	14.7	2 900	3 900	7230CDB	7230CDF	7230CDT	101.3	11.3	164	—	256	263	2.5	1	19.5	
	320	130	4	1.5	706	829	—	—	27.9	—	—	1 900	2 300	7330DB	7330DF	7330DT	200.7	70.7	168	—	302	311.5	3	1.5	44.8	
	320	130	4	1.5	645	760	—	—	25.6	—	—	1 400	1 900	7330BDB	7330BDF	7330BDT	262.2	132.2	168	—	302	311.5	3	1.5	44.8	
	320	130	4	1.5	760	891	—	—	30.0	—	13.7	2 600	3 400	7330CDB	7330CDF	7330CDT	128.0	2.0	168	—	302	311.5	3	1.5	44.8	
	160	220	56	2	1	245	289	—	—	10.9	—	16.5	3 500	4 700	7932CDB	7932CDF	7932CDT	78.9	22.9	170	—	210	214.5	2	1	5.20

[Notes] 1) Limiting speeds shown above are applicable to machined cage bearings. Limiting speeds of pressed cage bearings should be kept to under 80% of this value. For bearings with 15° contact angle, this figure is applied to the high precision bearings ranked higher than class 5, used with machined cages or molded cages.

2) B, C or no indication after the bearing number indicates nominal contact angle of 40°, 15° and 30° respectively. [Remark] Standard cage types used for the above bearings are described earlier in this section.

Angular contact ball bearings (matched pair)

d (160) ~ (180) mm

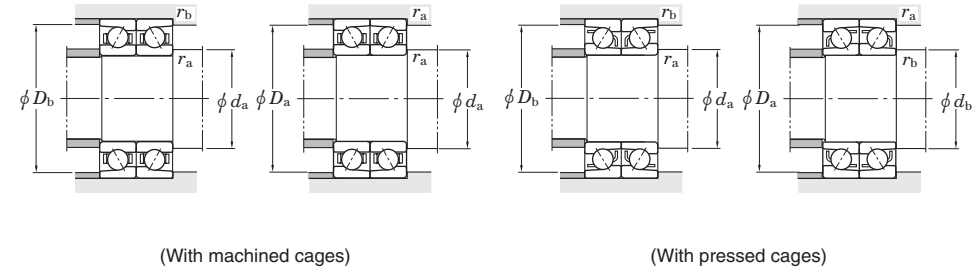
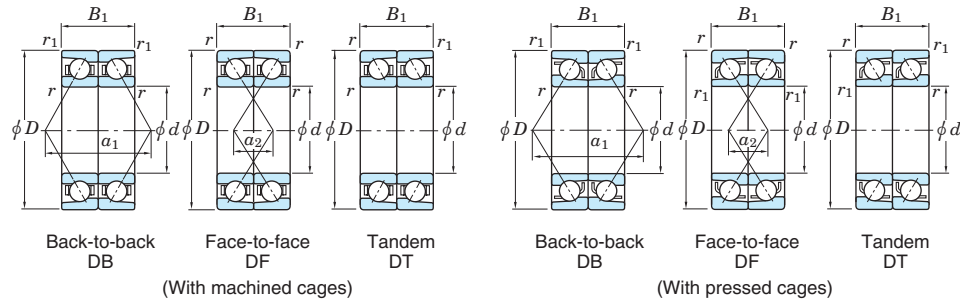

Boundary dimensions (mm)					Basic load ratings (kN)				Fatigue load limits (kN)		Factor f_0	Limiting speeds ¹⁾ (min ⁻¹)		Bearing No. ²⁾			Load center spread (mm)		Mounting dimensions (mm)						(Refer.) Mass (kg)
d	D	B ₁	r _{min.}	r _{1 min.}	With machined cages		With pressed cages		C _u (With machined cages)	C _u (With pressed cages)		Grease lub.	Oil lub.	Back-to-back DB	Face-to-face DF	Tandem DT	a ₁	a ₂	d _{a min.}	d _{b min.}	D _{a max.}	D _{b max.}	r _{a max.}	r _{b max.}	
160	240	76	2.1	1.1	315	353	—	—	13.3	—	—	2 300	2 800	7032DB	7032DF	7032DT	153.5	77.5	172	—	228	233	2	1	10.9
	240	76	2.1	1.1	282	316	—	—	11.6	—	—	1 700	2 300	7032BDB	7032BDF	7032BDT	205.8	129.8	172	—	228	233	2	1	10.9
	240	76	2.1	1.1	347	386	—	—	15.0	—	16.0	3 100	4 100	7032CDB	7032CDF	7032CDT	91.6	15.6	172	—	228	233	2	1	10.9
	290	96	3	1.1	468	525	—	—	18.1	—	—	2 000	2 500	7232DB	7232DF	7232DT	177.9	81.9	174	—	276	283	2.5	1	24.2
	290	96	3	1.1	482	557	—	—	19.2	—	—	1 500	2 000	7232BDB	7232BDF	7232BDT	236.8	140.8	174	—	276	283	2.5	1	24.2
	290	96	3	1.1	511	665	—	—	19.7	—	15.2	2 700	3 600	7232CDB	7232CDF	7232CDT	108.3	12.3	174	—	276	283	2.5	1	24.2
	340	136	4	1.5	741	909	—	—	29.7	—	—	1 700	2 200	7332DB	7332DF	7332DT	212.3	76.3	178	—	322	331.5	3	1.5	52.8
	340	136	4	1.5	675	831	—	—	27.2	—	—	1 300	1 700	7332BDB	7332BDF	7332BDT	277.8	141.8	178	—	322	331.5	3	1.5	52.8
	340	136	4	1.5	800	980	—	—	32.0	—	14.0	2 400	3 200	7332CDB	7332CDF	7332CDT	135.0	1.0	168.5	—	322	331.5	3	1.5	52.8
	170	230	56	2	1	255	302	—	—	11.5	—	16.6	3 100	4 100	7934CDB	7934CDF	7934CDT	81.6	25.6	180	—	220	224.5	2	1
260		84	2.1	1.1	377	429	—	—	15.8	—	—	2 100	2 600	7034DB	7034DF	7034DT	166.2	82.2	182	—	248	253	2	1	15.2
260		84	2.1	1.1	338	386	—	—	13.8	—	—	1 600	2 100	7034BDB	7034BDF	7034BDT	222.4	138.4	182	—	248	253	2	1	15.5
260		84	2.1	1.1	415	469	—	—	17.9	—	15.9	2 900	3 800	7034CDB	7034CDF	7034CDT	99.6	15.6	182	—	248	253	2	1	15.1
310		104	4	1.5	552	661	—	—	22.0	—	—	1 800	2 300	7234DB	7234DF	7234DT	190.6	86.6	188	—	292	301.5	3	1.5	30.2
310		104	4	1.5	497	600	—	—	20.0	—	—	1 400	1 800	7234BDB	7234BDF	7234BDT	253.4	149.4	188	—	292	301.5	3	1.5	30.2
310		104	4	1.5	603	719	—	—	24.0	—	15.1	2 500	3 300	7234CDB	7234CDF	7234CDT	116.3	12.3	188	—	292	301.5	3	1.5	30.2
360		144	4	1.5	789	969	—	—	30.7	—	—	1 600	2 000	7334DB	7334DF	7334DT	225.0	81.0	188	—	342	351.5	3	1.5	62.4
360		144	4	1.5	721	888	—	—	28.2	—	—	1 200	1 600	7334BDB	7334BDF	7334BDT	294.4	150.4	188	—	342	351.5	3	1.5	62.4
360		144	4	1.5	849	1 040	—	—	33.1	—	13.8	2 200	3 000	7334CDB	7334CDF	7334CDT	143.0	1.0	188	—	342	351.5	3	1.5	62.4
180	250	66	2	1	325	375	—	—	14.1	—	16.4	2 800	3 700	7936CDB	7936CDF	7936CDT	90.6	24.6	190	—	240	244.5	2	1	9.36
	280	92	2.1	1.1	430	506	—	—	18.3	—	—	1 900	2 400	7036DB	7036DF	7036DT	178.8	86.8	192	—	268	273	2	1	20.2
	280	92	2.1	1.1	385	457	—	—	15.9	—	—	1 400	1 900	7036BDB	7036BDF	7036BDT	239.0	147.0	192	—	268	273	2	1	20.4
	280	92	2.1	1.1	473	553	—	—	20.7	—	15.7	2 600	3 500	7036CDB	7036CDF	7036CDT	107.6	15.6	192	—	268	273	2	1	19.9
	320	104	4	1.5	596	724	—	—	23.7	—	—	1 700	2 200	7236DB	7236DF	7236DT	196.3	92.3	198	—	302	311.5	3	1.5	31.4
	320	104	4	1.5	538	657	—	—	21.5	—	—	1 300	1 700	7236BDB	7236BDF	7236BDT	261.8	157.8	198	—	302	311.5	3	1.5	31.4
	320	104	4	1.5	650	786	—	—	25.7	—	14.9	2 400	3 200	7236CDB	7236CDF	7236CDT	119.0	15.0	198	—	302	311.5	3	1.5	31.4
	380	150	4	1.5	831	1 070	—	—	33.0	—	—	1 500	1 900	7336DB	7336DF	7336DT	236.7	86.7	198	—	362	371.5	3	1.5	80.0

[Notes] 1) Limiting speeds shown above are applicable to machined cage bearings. Limiting speeds of pressed cage bearings should be kept to under 80% of this value. For bearings with 15° contact angle, this figure is applied to the high precision bearings ranked higher than class 5, used with machined cages or molded cages.

2) B, C or no indication after the bearing number indicates nominal contact angle of 40°, 15° and 30° respectively. [Remark] Standard cage types used for the above bearings are described earlier in this section.

Angular contact ball bearings (matched pair)

d (180) ~ 240 mm

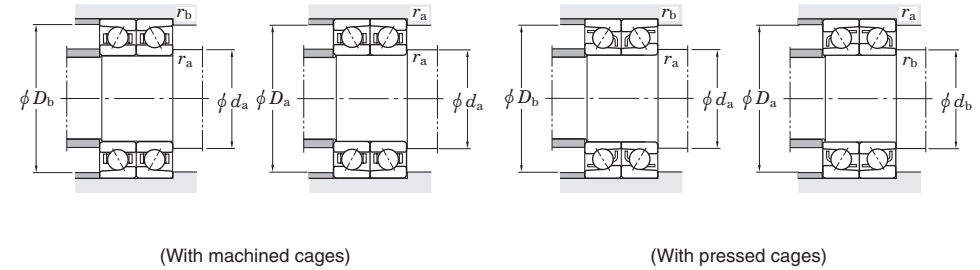
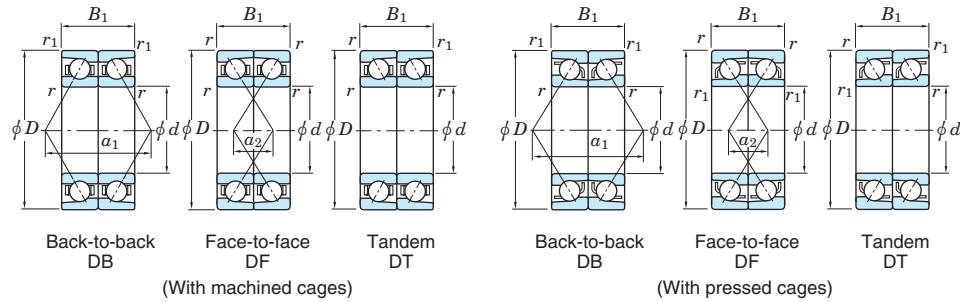

Boundary dimensions (mm)					Basic load ratings (kN)				Fatigue load limits (kN)		Factor f_0	Limiting speeds ¹⁾ (min ⁻¹)		Bearing No. ²⁾			Load center spread (mm)		Mounting dimensions (mm)						(Refer.) Mass (kg)	
d	D	B_1	$r_{min.}$	$r_{1min.}$	With machined cages		With pressed cages		C_u	C_{0r}		f_0	Grease lub.	Oil lub.	Back-to-back DB	Face-to-face DF	Tandem DT	a_1	a_2	d_a min.	d_b min.	D_a max.	D_b max.	r_a max.		r_b max.
180	380	150	4	1.5	757	976	—	—	30.1	—	—	1 100	1 500	7336BDB	7336BDF	7336BDT	309.9	159.9	198	—	362	371.5	3	1.5	80.0	
	260	66	2	1	322	394	—	—	13.7	—	16.5	2 700	3 600	7938CDB	7938CDF	7938CDT	93.3	27.3	200	—	250	254.5	2	1	9.66	
190	290	92	2.1	1.1	441	535	—	—	18.7	—	—	1 800	2 300	7038DB	7038DF	7038DT	184.6	92.6	202	—	278	283	2	1	21.6	
	290	92	2.1	1.1	395	483	—	—	16.3	—	—	1 400	1 800	7038BDB	7038BDF	7038BDT	247.4	155.4	202	—	278	283	2	1	21.6	
	290	92	2.1	1.1	485	585	—	—	21.1	—	15.9	2 500	3 300	7038CDB	7038CDF	7038CDT	110.3	18.3	202	—	278	283	2	1	21.6	
	340	110	4	1.5	616	779	—	—	24.7	—	—	1 600	2 000	7238DB	7238DF	7238DT	208.0	98.0	208	—	322	331.5	3	1.5	37.6	
	340	110	4	1.5	555	706	—	—	22.4	—	—	1 200	1 600	7238BDB	7238BDF	7238BDT	277.4	167.4	208	—	322	331.5	3	1.5	37.6	
	340	110	4	1.5	673	848	—	—	26.9	—	15.1	2 200	3 000	7238CDB	7238CDF	7238CDT	126.0	16.0	208	—	322	331.5	3	1.5	37.6	
	400	156	5	2	914	1 200	—	—	36.0	—	—	1 400	1 800	7338DB	7338DF	7338DT	248.3	92.3	212	—	378	390	4	2	91.0	
	400	156	5	2	835	1 100	—	—	33.0	—	—	1 100	1 400	7338BDB	7338BDF	7338BDT	325.5	169.5	212	—	378	390	4	2	91.0	
	200	280	76	2.1	1.1	415	509	—	—	17.4	—	16.3	2 500	3 300	7940CDB	7940CDF	7940CDT	102.3	26.3	212	—	268	273	2	1	13.7
		310	102	2.1	1.1	495	618	—	—	20.0	—	—	1 700	2 100	7040DB	7040DF	7040DT	198.3	96.3	212	—	298	303	2	1	25.4
310		102	2.1	1.1	443	558	—	—	18.1	—	—	1 300	1 700	7040BDB	7040BDF	7040BDT	265.0	163.0	212	—	298	303	2	1	25.4	
310		102	2.1	1.1	544	676	—	—	21.9	—	15.7	2 300	3 100	7040CDB	7040CDF	7040CDT	119.3	17.3	212	—	298	303	2	1	25.4	
360		116	4	1.5	658	847	—	—	26.2	—	—	1 500	1 900	7240DB	7240DF	7240DT	219.7	103.7	218	—	342	351.5	3	1.5	44.8	
360		116	4	1.5	593	768	—	—	23.7	—	—	1 100	1 500	7240BDB	7240BDF	7240BDT	292.9	176.9	218	—	342	351.5	3	1.5	44.8	
360		116	4	1.5	718	921	—	—	28.4	—	15.1	2 100	2 800	7240CDB	7240CDF	7240CDT	133.0	17.0	218	—	342	351.5	3	1.5	44.8	
420		160	5	2	964	1 320	—	—	38.6	—	—	1 300	1 700	7340DB	7340DF	7340DT	259.0	99.0	222	—	398	410	4	2	104	
420		160	5	2	878	1 200	—	—	35.3	—	—	1 000	1 300	7340BDB	7340BDF	7340BDT	340.1	180.1	222	—	398	410	4	2	104	
220		340	112	3	1.1	543	705	—	—	21.8	—	—	1 500	1 900	7044DB	7044DF	—	217.8	105.8	234	—	326	333	2.5	1	37.0
	340	112	3	1.1	486	636	—	—	19.6	—	—	1 100	1 500	7044BDB	7044BDF	—	290.9	178.9	234	—	326	333	2.5	1	37.8	
240	360	112	3	1.1	591	751	—	—	24.6	—	—	1 400	1 700	7048DB	7048DF	—	229.2	117.2	254	—	346	353	2.5	1	39.4	
	360	112	3	1.1	528	677	—	—	22.2	—	—	1 000	1 400	7048BDB	7048BDF	—	307.7	195.7	254	—	346	353	2.5	1	40.2	
	440	144	4	1.5	819	1 190	—	—	33.4	—	—	1 200	1 500	7248DB	7248DF	—	268.3	124.3	258	—	422	431.5	3	1.5	104	
	440	144	4	1.5	736	1 080	—	—	30.2	—	—	890	1 200	7248BDB	7248BDF	—	357.3	213.3	258	—	422	431.5	3	1.5	106	

[Notes] 1) Limiting speeds shown above are applicable to machined cage bearings. Limiting speeds of pressed cage bearings should be kept to under 80% of this value. For bearings with 15° contact angle, this figure is applied to the high precision bearings ranked higher than class 5, used with machined cages or molded cages.

2) B, C or no indication after the bearing number indicates nominal contact angle of 40°, 15° and 30° respectively. [Remark] Standard cage types used for the above bearings are described earlier in this section.

Angular contact ball bearings (matched pair)

d 260 ~ 380 mm

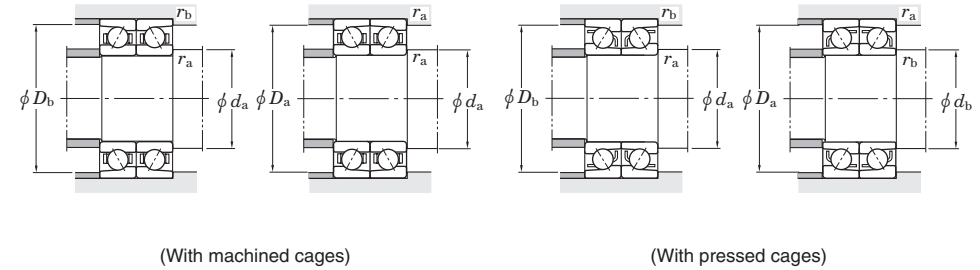
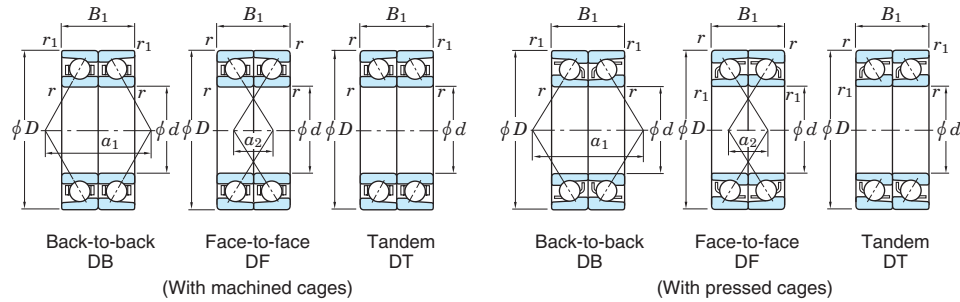

Boundary dimensions (mm)					Basic load ratings (kN)				Fatigue load limits (kN)		Factor f_0	Limiting speeds ¹⁾ (min ⁻¹)		Bearing No. ²⁾			Load center spread (mm)		Mounting dimensions (mm)						(Refer.) Mass (kg)
d	D	B ₁	r min.	r ₁ min.	With machined cages		With pressed cages		C _u (With machined cages)	C _u (With pressed cages)		Grease lub.	Oil lub.	Back-to-back DB	Face-to-face DF	Tandem DT	a ₁	a ₂	d _a min.	d _b min.	D _a max.	D _b max.	r _a max.	r _b max.	
260	400	130	4	1.5	661	956	—	—	27.1	—	—	1 200	1 500	7052DB	7052DF	—	256.7	126.7	278	—	382	391.5	3	1.5	57.4
	400	130	4	1.5	592	862	—	—	24.4	—	—	910	1 200	7052BDB	7052BDF	—	341.9	211.9	278	—	382	391.5	3	1.5	58.6
280	420	130	4	1.5	675	1 010	—	—	27.9	—	—	1 100	1 400	7056DB	7056DF	—	267.1	137.1	298	—	402	411.5	3	1.5	60.8
	420	130	4	1.5	623	906	—	—	26.2	—	—	850	1 100	7056BDB	7056BDF	—	358.7	228.7	298	—	402	411.5	3	1.5	62.0
300	460	148	4	1.5	866	1 360	—	—	36.0	—	—	1 000	1 300	7060DB	7060DF	—	293.4	145.4	318	—	442	451.5	3	1.5	87.4
	460	148	4	1.5	776	1 230	—	—	32.5	—	—	770	1 000	7060BDB	7060BDF	—	392.9	244.9	318	—	442	451.5	3	1.5	89.8
320	480	148	4	1.5	887	1 440	—	—	37.3	—	—	950	1 200	7064DB	7064DF	—	304.9	156.9	338	—	462	471.5	3	1.5	92.0
	480	148	4	1.5	795	1 300	—	—	33.6	—	—	710	950	7064BDB	7064BDF	—	409.6	261.6	338	—	462	471.5	3	1.5	94.4
340	520	164	5	2	1 020	1 720	—	—	42.9	—	—	860	1 100	7068DB	7068DF	—	330.3	166.3	362	—	498	510	4	2	124
	520	164	5	2	914	1 550	—	—	38.7	—	—	640	860	7068BDB	7068BDF	—	442.8	278.8	362	—	498	510	4	2	127
360	540	164	5	2	1 050	1 830	—	—	44.5	—	—	800	1 000	7072DB	7072DF	—	341.8	177.8	382	—	518	530	4	2	129
	540	164	5	2	937	1 650	—	—	40.1	—	—	600	800	7072BDB	7072BDF	—	459.6	295.6	382	—	518	530	4	2	132
380	560	164	5	2	1 070	1 930	—	—	46.0	—	—	750	940	7076DB	7076DF	—	353.4	189.4	402	—	538	550	4	2	134
	560	164	5	2	959	1 740	—	—	41.5	—	—	560	750	7076BDB	7076BDF	—	476.4	312.4	402	—	538	550	4	2	138

[Notes] 1) Limiting speeds shown above are applicable to machined cage bearings. Limiting speeds of pressed cage bearings should be kept to under 80% of this value. For bearings with 15° contact angle, this figure is applied to the high precision bearings ranked higher than class 5, used with machined cages or molded cages.

2) B or no indication after the bearing number indicates nominal contact angle of 40° and 30° respectively. [Remark] Standard cage types used for the above bearings are described earlier in this section.

Double-row angular contact ball bearings

d 10 ~ (40) mm

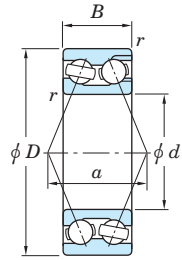

32, 33 series
(With filling slot)

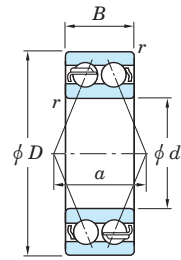

Open



Shielded



Contact sealed

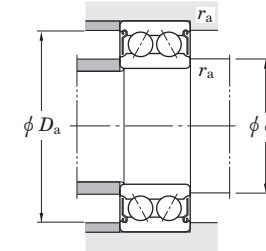
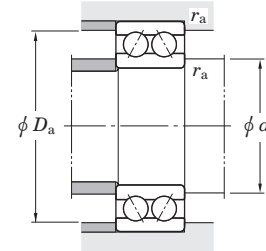

52, 53 series
(Without filling slot)

Boundary dimensions (mm)				Basic load ratings (kN)				Fatigue load limits (kN)		Limiting speeds (min ⁻¹)			Bearing No.			Load center spread (mm) Open a	Mounting dimensions ¹⁾ (mm)			(Refer.) Mass (kg)	
d	D	B	$r_{min.}$	Open		Shielded/sealed		C_u	Grease lub.		Oil lub.		Open	Shielded	Sealed		d_a	D_a	r_a		
				C_r	C_{0r}	C_r	C_{0r}	(Open)	(Shielded/sealed)	[Open] [Z, ZZ]	(RS, 2RS)	[Open] [Z]				min.	max.	max.	max.		
10	30	14.3	0.6	9.15	5.35	—	—	0.280	—	15 000	—	20 000	3200	—	—	19.5	14.5	—	25.5	0.6	0.052
12	32	15.9	0.6	12.1	7.15	—	—	0.370	—	14 000	—	18 000	3201	—	—	21.7	16.5	—	27.5	0.6	0.063
15	35	15.9	0.6	12.1	7.45	—	—	0.390	—	12 000	—	16 000	3202	—	—	23.6	19.5	—	30.5	0.6	0.072
	42	19	1	19.0	11.9	—	—	0.610	—	10 000	—	14 000	3302	—	—	27.6	20.5	—	36.5	1	0.132
17	40	17.5	0.6	17.2	10.8	—	—	0.560	—	11 000	—	14 000	3203	—	—	26.6	21.5	—	35.5	0.6	0.100
	40	17.5	0.6	16.5	8.15	15.9	8.35	0.420	0.430	11 000	11 000	14 000	5203	5203 ZZ	5203 2RS	20.0	21.5	23.5	35.5	0.6	0.091
	47	22.2	1	23.0	17.1	—	—	0.760	—	9 400	—	13 000	3303	—	—	31.0	22.5	—	41.5	1	0.192
20	47	20.6	1	21.5	15.0	—	—	0.770	—	9 000	—	12 000	3204	—	—	31.5	25.5	—	41.5	1	0.170
	47	20.6	1	24.6	12.5	20.0	10.8	0.640	0.560	8 800	8 800	12 000	5204	5204 ZZ	5204 2RS	23.5	25.5	26.6	41.5	1	0.158
	52	22.2	1.1	26.0	18.4	—	—	0.950	—	8 200	—	11 000	3304	—	—	33.8	27	—	45	1	0.230
	52	22.2	1.1	30.9	15.0	24.7	12.8	0.780	0.660	8 300	8 300	11 000	5304	5304 ZZ	5304 2RS	25.9	27	28.3	45	1	0.230
25	52	20.6	1	23.7	18.2	—	—	0.940	—	7 800	—	10 000	3205	—	—	34.4	30.5	—	46.5	1	0.190
	52	20.6	1	26.7	14.8	23.6	13.8	0.760	0.710	7 700	7 700	10 000	5205	5205 ZZ	5205 2RS	26.1	30.5	32.3	46.5	1	0.190
	62	25.4	1.1	36.2	26.5	—	—	1.35	—	6 800	—	9 100	3305	—	—	40.5	32	—	55	1	0.369
	62	25.4	1.1	40.9	20.8	34.3	18.5	1.05	0.960	6 900	6 900	9 200	5305	5305 ZZ	5305 2RS	31.1	32	33.4	55	1	0.340
30	62	23.8	1	34.1	27.0	—	—	1.40	—	6 500	—	8 700	3206	—	—	40.7	35.5	—	56.5	1	0.320
	62	23.8	1	37.2	21.3	31.7	18.3	1.10	0.950	6 400	6 400	8 600	5206	5206 ZZ	5206 2RS	30.8	35.5	38.6	56.5	1	0.290
	72	30.2	1.1	47.7	36.1	—	—	1.85	—	5 800	—	7 800	3306	—	—	47.2	37	—	65	1	0.585
	72	30.2	1.1	51.2	28.5	42.9	25.2	1.45	1.30	5 800	5 800	7 700	5306	5306 ZZ	5306 2RS	36.2	37	41.3	65	1	0.510
35	72	27	1.1	46.0	37.5	—	—	1.95	—	5 600	—	7 500	3207	—	—	46.9	42	—	65	1	0.480
	72	27	1.1	49.0	29.0	39.7	24.6	1.50	1.25	5 500	5 500	7 300	5207	5207 ZZ	5207 2RS	36.1	42	43.9	65	1	0.430
	80	34.9	1.5	60.7	46.8	—	—	2.40	—	5 200	—	7 000	3307	—	—	53.4	43.5	—	71.5	1.5	0.816
	80	34.9	1.5	64.0	36.2	57.6	32.8	1.85	1.70	5 100	5 100	6 800	5307	5307 ZZ	5307 2RS	41.0	43.5	45.5	71.5	1.5	0.790
40	80	30.2	1.1	52.4	43.9	—	—	2.25	—	5 000	—	6 700	3208	—	—	52.6	47	—	73	1	0.650
	80	30.2	1.1	55.5	33.6	45.7	29.1	1.75	1.50	5 000	5 000	6 700	5208	5208 ZZ	5208 2RS	39.2	47	49.5	73	1	0.570

[Note] 1) The maximum value of d_a is applied to shielded and sealed type bearings.

[Remark] Standard cage types used for the above bearings are described earlier in this section.

Double-row angular contact ball bearings

d (40) ~ 70 mm

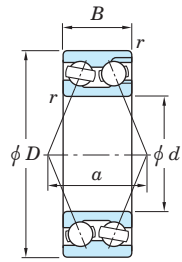

32, 33 series
(With filling slot)

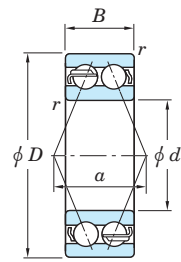

Open

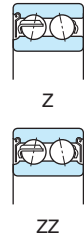

ZZ

Shielded

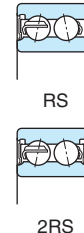

RS

Contact sealed

52, 53 series
(Without filling slot)

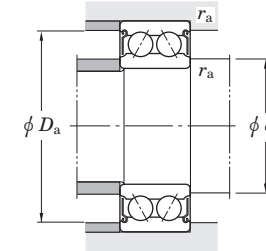
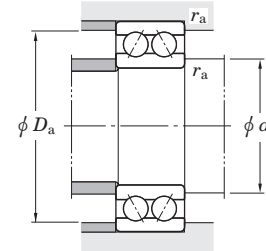

Boundary dimensions (mm)				Basic load ratings (kN)				Fatigue load limits (kN)		Limiting speeds (min ⁻¹)			Bearing No.			Load center spread (mm)	Mounting dimensions ¹⁾ (mm)			(Refer.) Mass (kg)	
d	D	B	$r_{min.}$	Open		Shielded/sealed		C_u		Grease lub. Oil lub.			Open	Shielded	Sealed	Open α	d_a				
				C_r	C_{0r}	C_r	C_{0r}	(Open)	(Shielded/sealed)	[Open] Z, ZZ	(RS, 2RS)	[Open] Z					min.	max.	D_a max.	r_a max.	
40	90	36.5	1.5	67.6	53.8	—	—	2.80	—	4 600	—	6 100	3308	—	—	58.9	48.5	—	81.5	1.5	1.07
	90	36.5	1.5	78.3	45.4	64.3	37.8	2.35	1.95	4 600	4 600	6 100	5308	5308 ZZ	5308 2RS	44.9	48.5	52.1	81.5	1.5	1.05
45	85	30.2	1.1	56.8	51.4	—	—	2.65	—	4 600	—	6 100	3209	—	—	56.3	52	—	78	1	0.710
	85	30.2	1.1	62.3	38.4	52.1	33.9	2.00	1.75	4 600	4 600	6 100	5209	5209 ZZ	5209 2RS	42.2	52	55.3	78	1	0.620
	100	39.7	1.5	82.6	67.3	—	—	3.50	—	4 100	—	5 500	3309	—	—	65.6	53.5	—	91.5	1.5	1.42
	100	39.7	1.5	93.8	55.7	86.1	51.4	2.90	2.65	4 100	4 100	5 500	5309	5309 ZZ	5309 2RS	51.0	53.5	58.2	91.5	1.5	1.42
50	90	30.2	1.1	56.4	52.1	—	—	2.70	—	4 300	—	5 700	3210	—	—	58.8	57	—	83	1	0.760
	90	30.2	1.1	66.7	43.6	55.2	37.9	2.25	1.95	4 300	4 300	5 600	5210	5210 ZZ	5210 2RS	44.5	57	58.9	83	1	0.670
	110	44.4	2	108	88.6	—	—	4.60	—	3 800	—	5 000	3310	—	—	71.7	60	—	100	2	1.95
	110	44.4	2	111	67.0	102	62.2	3.45	3.20	3 600	3 600	4 800	5310	5310 ZZ	5310 2RS	56.6	60	64.4	100	2	1.93
55	100	33.3	1.5	63.6	60.2	—	—	3.10	—	3 900	—	5 100	3211	—	—	65.0	63.5	—	91.5	1.5	1.05
	100	33.3	1.5	82.3	55.2	66.1	44.7	2.85	2.30	3 800	3 800	5 100	5211	5211 ZZ	5211 2RS	50.2	63.5	66.2	91.5	1.5	0.960
	120	49.2	2	126	106	—	—	5.45	—	3 400	—	4 500	3311	—	—	79.3	65	—	110	2	2.53
	120	49.2	2	138	85.1	120	74.3	4.40	3.85	3 300	3 300	4 500	5311	5311 ZZ	5311 2RS	61.6	65	71.8	110	2	2.30
60	110	36.5	1.5	80.0	76.8	—	—	3.95	—	3 500	—	4 700	3212	—	—	71.3	68.5	—	101.5	1.5	1.40
	110	36.5	1.5	93.0	60.8	78.3	55.9	3.15	2.90	3 500	3 500	4 700	5212	5212 ZZ	5212 2RS	53.8	68.5	74.1	101.5	1.5	1.36
	130	54	2.1	156	132	—	—	6.85	—	3 100	—	4 200	3312	—	—	87.4	72	—	118	2	3.24
	130	54	2.1	157	98.7	138	87.1	5.10	4.50	3 100	3 100	4 100	5312	5312 ZZ	5312 2RS	67.2	72	79.2	118	2	3.16
65	120	38.1	1.5	95.5	97.4	—	—	5.05	—	3 200	—	4 300	3213	—	—	76.8	73.5	—	111.5	1.5	1.75
	120	38.1	1.5	109	75.3	86.5	63.1	3.90	3.25	3 200	3 200	4 300	5213	5213 ZZ	5213 2RS	58.8	73.5	79.0	111.5	1.5	1.66
	140	58.7	2.1	177	153	—	—	7.80	—	2 900	—	3 900	3313	—	—	92.7	77	—	128	2	4.08
	140	58.7	2.1	178	113	178	113	5.75	5.75	2 900	2 900	3 900	5313	5313 ZZ	5313 2RS	70.9	77	85.9	128	2	3.91
70	125	39.7	1.5	97.4	96.4	—	—	5.00	—	3 100	—	4 100	3214	—	—	80.7	78.5	—	116.5	1.5	1.92
	125	39.7	1.5	118	82.6	95.4	70.3	4.25	3.65	3 100	3 100	4 100	5214	5214 ZZ	5214 2RS	61.4	78.5	83.5	116.5	1.5	1.81
	150	63.5	2.1	188	160	—	—	7.90	—	2 700	—	3 600	3314	—	—	99.7	82	—	138	2	5.04
	150	63.5	2.1	200	129	200	129	6.35	6.35	2 700	2 700	3 600	5314	5314 ZZ	5314 2RS	76.0	82	92.9	138	2	4.89

[Note] 1) The maximum value of d_a is applied to shielded and sealed type bearings.

[Remark] Standard cage types used for the above bearings are described earlier in this section.

Double-row angular contact ball bearings

d 75 ~ 110 mm

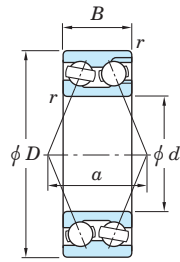

32, 33 series
(With filling slot)

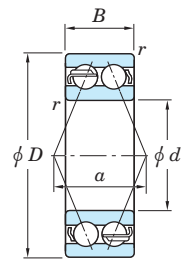

Open



Z



ZZ

Shielded



RS



2RS

Contact sealed

52, 53 series
(Without filling slot)

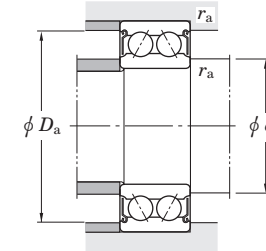
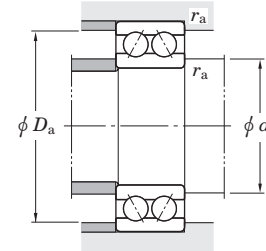

Boundary dimensions (mm)				Basic load ratings (kN)				Fatigue load limits (kN)		Limiting speeds (min ⁻¹)			Bearing No.			Load center spread (mm)	Mounting dimensions ¹⁾ (mm)				(Refer.) Mass (kg)	
d	D	B	$r_{min.}$	Open		Shielded/sealed		C_u		Grease lub.		Oil lub.		Open	Shielded	Sealed	α	d_a	D_a	r_a		
				C_r	C_{0r}	C_r	C_{0r}	(Open)	(Shielded/sealed)	[Open Z, ZZ]	(RS, 2RS)	[Open Z]						min.	max.	max.	max.	
75	130	41.3	1.5	116	120	—	—	6.15	—	2 900	—	3 900	3215	—	—	—	84.7	83.5	—	121.5	1.5	2.10
	160	68.3	2.1	211	189	—	—	9.00	—	2 500	—	3 300	3315	—	—	—	108.7	87	—	148	2	6.16
	160	68.3	2.1	218	147	218	147	6.95	6.95	2 500	2 500	3 300	5315	5315 ZZ	5315 2RS	—	81.5	87	99.6	148	2	5.97
80	140	44.4	2	122	121	—	—	5.95	—	2 700	—	3 600	3216	—	—	—	90.7	90	—	130	2	2.64
	170	68.3	2.1	230	213	—	—	9.85	—	2 400	—	3 100	3316	—	—	—	113.1	92	—	158	2	6.93
85	150	49.2	2	143	143	—	—	6.80	—	2 500	—	3 400	3217	—	—	—	98.4	95	—	140	2	3.39
	180	73	3	235	219	—	—	9.80	—	2 200	—	3 000	3317	—	—	—	118.8	99	—	166	2.5	8.30
90	160	52.4	2	165	167	—	—	7.70	—	2 400	—	3 100	3218	—	—	—	104.1	100	—	150	2	4.14
	190	73	3	256	242	—	—	10.6	—	2 100	—	2 800	3318	—	—	—	125.5	104	—	176	2.5	9.23
95	170	55.6	2.1	189	193	—	—	8.65	—	2 200	—	3 000	3219	—	—	—	110.6	107	—	158	2	5.00
	200	77.8	3	273	270	—	—	14.9	—	2 000	—	2 600	3319	—	—	—	132.2	109	—	186	2.5	10.9
100	180	60.3	2.1	215	221	—	—	9.65	—	2 100	—	2 800	3220	—	—	—	116.8	112	—	168	2	6.10
	215	82.6	3	312	324	—	—	17.4	—	1 800	—	2 500	3320	—	—	—	140.4	114	—	201	2.5	13.5
105	190	65.1	2.1	227	237	—	—	11.5	—	2 000	—	2 600	3221	—	—	—	124.2	117	—	178	2	7.37
	225	87.3	3	331	354	—	—	18.5	—	1 800	—	2 300	3321	—	—	—	148.1	119	—	211	2.5	15.6
110	200	69.8	2.1	251	263	—	—	10.9	—	1 900	—	2 500	3222	—	—	—	131.4	122	—	188	2	8.80
	240	92.1	3	352	388	—	—	15.1	—	1 600	—	2 200	3322	—	—	—	156.4	124	—	226	2.5	18.9

[Note] 1) The maximum value of d_a is applied to shielded and sealed type bearings.

[Remark] Standard cage types used for the above bearings are described earlier in this section.

Self-aligning ball bearings

Self-aligning ball bearings have a spherical outer ring raceway, the center of whose curvature meets that of the bearing itself, so that the inner ring, balls and cage continue to rotate, aligning themselves if they have become misaligned within design limits.

This type of bearing is suitable when the displacement of the centers around which the shaft and housing rotate and shaft deflection are likely to occur.

Bearings with a tapered bore can easily be fit to the shaft with an adapter assembly.

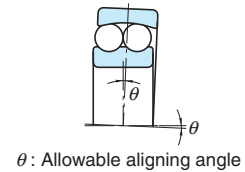

Self-aligning ball bearings



Cylindrical bore

Bore diameter 10 – 90 mm



Tapered bore

Bore diameter 10 – 55 mm



Sealed type

Bore diameter 10 – 55 mm

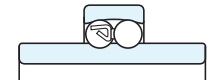

Extended inner ring type

Bore diameter 20 – 60 mm

Adapter assemblies

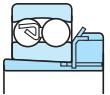

Bore diameter 17 – 80 mm

Boundary dimensions	The dimensions of standard series are as specified in JIS B 1512.
Tolerances	As specified in JIS B 1514-1, class 0. (refer to Table 7-3 on pp. A 60 – A 63.)
Radial internal clearance	As specified in JIS B 1520. (refer to Table 10-6 on p. A 105.)
Recommended fits	Refer to Table 9-4 on pp. A 91, 92.
Standard cages	<ul style="list-style-type: none"> Staggered type pressed steel cage (application : all dimensional range of 12, 13, 112, 113, 22...2RS and 23...2RS series) Snap type pressed steel cage (application : all dimensional range of 22 series and those of No. 2300 thru 2316.)
Allowable aligning angle	<ul style="list-style-type: none"> 12 and 22 series0.044 rad (2.5°) 13 and 23 series0.052 rad (3°) 22...2RS and 23...2RS series0.026 rad (1.5°)

Dynamic equivalent radial load

$$P_r = X F_r + Y F_a$$

$F_a / F_r \leq e$		$F_a / F_r > e$	
X	Y	X	Y
1	Y_1	0.65	Y_2

Static equivalent radial load

$$P_{0r} = F_r + Y_0 F_a$$

Refer to the bearing specification table for values of e , Y_1 , Y_2 and Y_0 .

Self-aligning ball bearings open type

d 10 ~ (35) mm

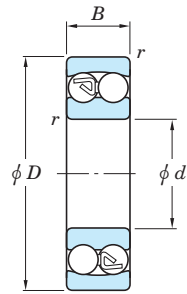

Cylindrical bore

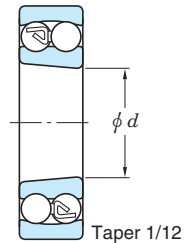

Tapered bore
Taper 1/12

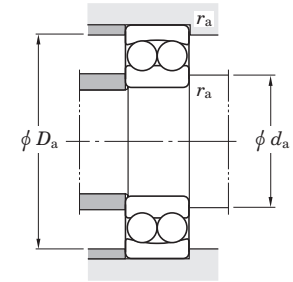

Boundary dimensions (mm)				Basic load ratings (kN)		Fatigue load limit (kN) C_u	Limiting speeds (min^{-1})		Bearing No.		Mounting dimensions (mm)			Con-stant e	Axial load factors			(Refer.) Mass (kg)	
d	D	B	$r_{\text{min.}}$	C_r	C_{0r}		Grease lub.	Oil lub.	Cylindrical bore	Tapered bore	d_a min.	D_a max.	r_a max.		Y_1	Y_2	Y_0	Cylindrical bore	Tapered bore
10	30	9	0.6	5.50	1.20	0.08	23 000	28 000	1200	—	14	26	0.6	0.33	1.92	2.97	2.01	0.034	—
	30	14	0.6	7.40	1.60	0.10	23 000	29 000	2200	—	14	26	0.6	0.59	1.07	1.65	1.12	0.047	—
12	32	10	0.6	5.60	1.25	0.08	21 000	26 000	1201	—	16	28	0.6	0.33	1.89	2.93	1.98	0.040	—
	32	14	0.6	7.65	1.75	0.11	21 000	26 000	2201	—	16	28	0.6	0.53	1.18	1.83	1.24	0.053	—
15	35	11	0.6	7.45	1.75	0.11	18 000	22 000	1202	—	19	31	0.6	0.33	1.90	2.95	2.00	0.049	—
	35	14	0.6	7.70	1.85	0.12	18 000	22 000	2202	—	19	31	0.6	0.50	1.27	1.97	1.33	0.060	—
	42	13	1	9.55	2.30	0.14	16 000	20 000	1302	—	20	37	1	0.34	1.86	2.88	1.95	0.094	—
	42	17	1	12.1	2.90	0.18	14 000	20 000	2302	—	20	37	1	0.50	1.27	1.96	1.33	0.114	—
17	40	12	0.6	7.90	2.05	0.13	16 000	20 000	1203	—	21	36	0.6	0.31	2.03	3.14	2.12	0.073	—
	40	16	0.6	9.80	2.40	0.15	16 000	20 000	2203	—	21	36	0.6	0.50	1.27	1.96	1.33	0.088	—
	47	14	1	12.5	3.20	0.20	14 000	17 000	1303	—	22	42	1	0.33	1.92	2.97	2.01	0.130	—
	47	19	1	14.5	3.60	0.23	13 000	18 000	2303	—	22	42	1	0.49	1.28	1.98	1.34	0.158	—
20	47	14	1	9.90	2.65	0.16	14 000	17 000	1204	1204K	25	42	1	0.29	2.16	3.35	2.27	0.120	0.118
	47	18	1	12.6	3.25	0.21	14 000	17 000	2204	2204K	25	42	1	0.48	1.31	2.02	1.37	0.140	0.136
	52	15	1.1	12.4	3.35	0.21	13 000	15 000	1304	1304K	26.5	45.5	1	0.30	2.12	3.28	2.22	0.163	0.161
	52	21	1.1	18.0	4.65	0.30	11 000	15 000	2304	2304K	26.5	45.5	1	0.49	1.29	2.00	1.35	0.209	0.205
25	52	15	1	12.1	3.30	0.21	12 000	14 000	1205	1205K	30	47	1	0.28	2.28	3.52	2.39	0.141	0.138
	52	18	1	12.6	3.50	0.22	12 000	15 000	2205	2205K	30	47	1	0.40	1.58	2.45	1.66	0.163	0.158
	62	17	1.1	18.0	5.05	0.32	9 900	12 000	1305	1305K	31.5	55.5	1	0.27	2.31	3.57	2.42	0.257	0.252
	62	24	1.1	24.5	6.55	0.42	9 400	13 000	2305	2305K	31.5	55.5	1	0.46	1.36	2.10	1.42	0.335	0.327
30	62	16	1	15.6	4.70	0.29	9 900	12 000	1206	1206K	35	57	1	0.25	2.55	3.94	2.67	0.220	0.216
	62	20	1	15.5	4.65	0.29	10 000	12 000	2206	2206K	35	57	1	0.35	1.79	2.77	1.87	0.260	0.254
	72	19	1.1	21.3	6.30	0.40	8 700	11 000	1306	1306K	36.5	65.5	1	0.26	2.40	3.72	2.52	0.387	0.381
	72	27	1.1	31.5	8.70	0.55	8 000	11 000	2306	2306K	36.5	65.5	1	0.44	1.44	2.23	1.51	0.500	0.489
35	72	17	1.1	15.8	5.15	0.32	8 500	10 000	1207	1207K	41.5	65.5	1	0.23	2.71	4.20	2.84	0.323	0.317

[Remark] Standard cage types used for the above bearings are described earlier in this section.

Self-aligning ball bearings open type

d (35) ~ 65 mm

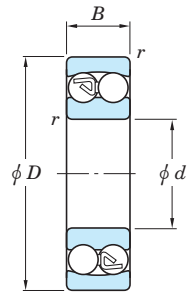

Cylindrical bore

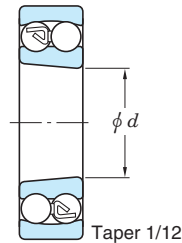

Tapered bore

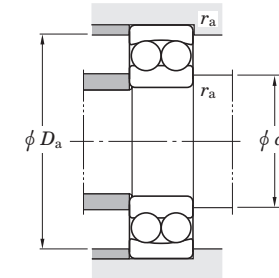

Boundary dimensions (mm)				Basic load ratings (kN)		Fatigue load limit (kN)	Limiting speeds (min ⁻¹)		Bearing No.		Mounting dimensions (mm)			Con-stant	Axial load factors			(Refer.) Mass (kg)	
d	D	B	$r_{min.}$	C_r	C_{0r}	C_u	Grease lub.	Oil lub.	Cylindrical bore	Tapered bore	d_a min.	D_a max.	r_a max.	e	Y_1	Y_2	Y_0	Cylindrical bore	Tapered bore
35	72	23	1.1	21.6	6.65	0.42	8 500	10 000	2207	2207K	41.5	65.5	1	0.37	1.71	2.65	1.79	0.403	0.396
	80	21	1.5	25.1	7.95	0.49	7 600	9 300	1307	1307K	43	72	1.5	0.25	2.48	3.84	2.60	0.510	0.502
	80	31	1.5	39.5	11.1	0.71	7 100	9 800	2307	2307K	43	72	1.5	0.45	1.39	2.15	1.46	0.675	0.657
40	80	18	1.1	19.2	6.50	0.41	7 500	9 200	1208	1208K	46.5	73.5	1	0.22	2.83	4.38	2.97	0.417	0.411
	80	23	1.1	22.4	7.35	0.46	7 600	9 300	2208	2208K	46.5	73.5	1	0.33	1.92	2.96	2.01	0.505	0.494
	90	23	1.5	29.6	9.80	0.61	6 900	8 400	1308	1308K	48	82	1.5	0.25	2.57	3.98	2.69	0.715	0.704
	90	33	1.5	44.9	13.4	0.85	6 200	8 600	2308	2308K	48	82	1.5	0.43	1.47	2.27	1.54	0.925	0.903
45	85	19	1.1	21.8	7.35	0.46	7 000	8 500	1209	1209K	51.5	78.5	1	0.21	2.94	4.56	3.09	0.465	0.459
	85	23	1.1	23.3	8.15	0.51	7 000	8 500	2209	2209K	51.5	78.5	1	0.30	2.09	3.23	2.19	0.545	0.533
	100	25	1.5	38.1	12.9	0.80	6 100	7 500	1309	1309K	53	92	1.5	0.25	2.56	3.95	2.68	0.957	0.942
	100	36	1.5	54.4	16.6	1.05	5 600	7 700	2309	2309K	53	92	1.5	0.42	1.51	2.33	1.58	1.23	1.20
50	90	20	1.1	22.7	8.10	0.51	6 500	7 900	1210	1210K	56.5	83.5	1	0.21	3.07	4.76	3.22	0.525	0.515
	90	23	1.1	23.3	8.50	0.53	6 500	7 900	2210	2210K	56.5	83.5	1	0.27	2.33	3.61	2.45	0.590	0.577
	110	27	2	43.4	14.2	0.89	5 600	6 800	1310	1310K	59	101	2	0.23	2.70	4.17	2.83	1.21	1.19
	110	40	2	64.6	20.1	1.25	5 100	7 000	2310	2310K	59	101	2	0.40	1.56	2.41	1.63	1.64	1.60
55	100	21	1.5	26.8	10.0	0.63	5 800	7 100	1211	1211K	63	92	1.5	0.20	3.19	4.94	3.34	0.705	0.693
	100	25	1.5	26.5	9.95	0.62	5 800	7 100	2211	2211K	63	92	1.5	0.27	2.35	3.64	2.47	0.810	0.792
	120	29	2	51.3	18.1	1.10	5 000	6 200	1311	1311K	64	111	2	0.23	2.70	4.18	2.83	1.58	1.56
	120	43	2	75.4	23.8	1.50	4 600	6 400	2311	2311K	64	111	2	0.41	1.53	2.37	1.60	2.10	2.05
60	110	22	1.5	30.2	11.6	0.73	5 200	6 400	1212	1212K	68	102	1.5	0.19	3.37	5.22	3.53	0.900	0.885
	110	28	1.5	34.1	12.5	0.80	5 300	6 500	2212	2212K	68	102	1.5	0.28	2.26	3.49	2.36	1.09	1.07
	130	31	2.1	57.1	20.8	1.30	4 500	5 500	1312	1312K	71	119	2	0.22	2.91	4.50	3.05	1.96	1.93
	130	46	2.1	87.3	28.1	1.80	4 200	5 800	2312	2312K	71	119	2	0.39	1.62	2.51	1.70	2.60	2.53
65	120	23	1.5	31.0	12.4	0.79	4 800	5 800	1213	1213K	73	112	1.5	0.17	3.67	5.68	3.84	1.15	1.13
	120	31	1.5	43.6	16.4	1.05	4 900	5 900	2213	2213K	73	112	1.5	0.28	2.24	3.47	2.35	1.46	1.43
	140	33	2.1	61.7	22.9	1.40	4 300	5 200	1313	1313K	76	129	2	0.23	2.73	4.23	2.86	2.45	2.41

[Remark] Standard cage types used for the above bearings are described earlier in this section.

Self-aligning ball bearings
open type

d 70 ~ 90 mm

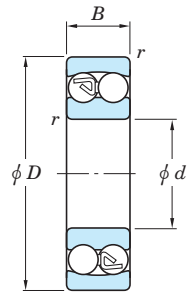

Cylindrical bore

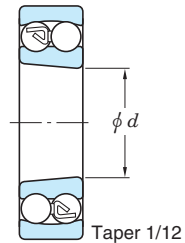

Tapered bore

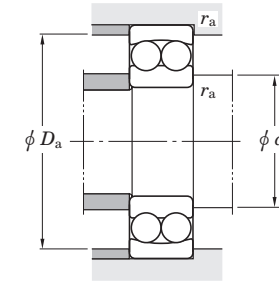

Boundary dimensions (mm)				Basic load ratings (kN)		Fatigue load limit (kN) C_u	Limiting speeds (min^{-1})		Bearing No.		Mounting dimensions (mm)			Con-stant e	Axial load factors			(Refer.) Mass (kg)	
d	D	B	$r_{\text{min.}}$	C_r	C_{0r}		Grease lub.	Oil lub.	Cylindrical bore	Tapered bore	d_a min.	D_a max.	r_a max.		Y_1	Y_2	Y_0	Cylindrical bore	Tapered bore
70	125	24	1.5	34.7	13.7	0.87	4 600	5 700	1214	—	78	117	1.5	0.18	3.48	5.38	3.64	1.26	—
	150	35	2.1	74.0	27.6	1.65	4 000	4 900	1314	—	81	139	2	0.22	2.84	4.40	2.98	2.99	—
75	130	25	1.5	38.8	15.5	0.97	4 300	5 300	1215	1215K	83	122	1.5	0.17	3.60	5.58	3.77	1.36	1.34
	160	37	2.1	78.9	29.9	1.70	4 000	4 900	1315	1315K	86	149	2	0.23	2.80	4.33	2.93	3.56	3.51
80	140	26	2	39.7	16.9	1.00	4 000	4 900	1216	1216K	89	131	2	0.16	3.90	6.03	4.08	1.67	1.64
	170	39	2.1	88.1	32.9	1.85	3 500	4 300	1316	1316K	91	159	2	0.22	2.90	4.49	3.04	4.18	4.12
85	150	28	2	49.2	20.5	1.20	3 800	4 600	1217	1217K	94	141	2	0.17	3.61	5.59	3.78	2.07	2.04
	180	41	3	97.3	37.8	2.05	3 300	4 000	1317	1317K	98	167	2.5	0.22	2.93	4.53	3.07	4.98	4.91
90	160	30	2	56.8	23.4	1.30	3 500	4 300	1218	1218K	99	151	2	0.17	3.69	5.70	3.86	2.52	2.48
	190	43	3	116	44.7	2.35	3 100	3 800	1318	1318K	103	177	2.5	0.22	2.81	4.35	2.94	5.80	5.71

[Remark] Standard cage types used for the above bearings are described earlier in this section.

Self-aligning ball bearings
sealed type

d 10 ~ 55 mm

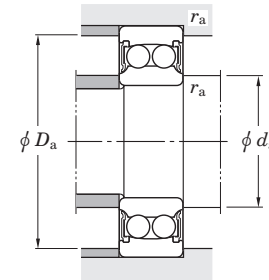
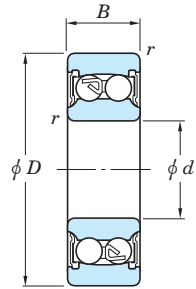

Boundary dimensions (mm)				Basic load ratings (kN)		Fatigue load limit (kN)	Limiting speed (min ⁻¹)	Bearing No.	Mounting dimensions (mm)				Constant e	Axial load factors			(Refer.) Mass (kg)
d	D	B	$r_{min.}$	C_r	C_{0r}	C_u	Grease lub.		min. d_a	max. d_a	max. D_a	max. r_a		Y_1	Y_2	Y_0	
10	30	14	0.6	5.50	1.20	0.08	15 000	2200 2RS	13.7	13.7	25	0.6	0.33	1.92	2.97	2.01	0.047
12	32	14	0.6	5.60	1.25	0.08	14 000	2201 2RS	15.2	15.2	27	0.6	0.33	1.89	2.93	1.98	0.053
15	35	14	0.6	7.45	1.75	0.11	12 000	2202 2RS 2302 2RS	18.0	18.0	30	0.6	0.33	1.90	2.95	2.00	0.060
	42	17	1	9.55	2.30	0.14	11 000		20.0	20.0	36	1	0.34	1.86	2.88	1.95	0.114
17	40	16	0.6	7.90	2.05	0.13	11 000	2203 2RS 2303 2RS	20.2	20.2	35	0.6	0.31	2.03	3.14	2.12	0.088
	47	19	1	12.5	3.20	0.20	9 400		22.1	22.1	41	1	0.33	1.92	2.97	2.01	0.158
20	47	18	1	9.90	2.65	0.16	9 100	2204 2RS 2304 2RS	24.1	24.1	41	1	0.29	2.16	3.35	2.27	0.140
	52	21	1.1	12.4	3.35	0.21	8 300		26.2	26.2	45	1	0.30	2.12	3.28	2.22	0.209
25	52	18	1	12.1	3.30	0.21	7 900	2205 2RS 2305 2RS	29.4	29.4	46	1	0.28	2.28	3.52	2.39	0.163
	62	24	1.1	18.0	5.05	0.32	6 600		32	33.9	55	1	0.27	2.31	3.57	2.42	0.335
30	62	20	1	15.6	4.70	0.29	6 600	2206 2RS 2306 2RS	35.5	35.5	56	1	0.25	2.55	3.94	2.67	0.260
	72	27	1.1	21.3	6.30	0.40	5 800		37	37.8	65	1	0.26	2.40	3.72	2.52	0.500
35	72	23	1.1	15.8	5.15	0.32	5 700	2207 2RS 2307 2RS	40.9	40.9	65	1	0.23	2.71	4.20	2.84	0.403
	80	31	1.5	25.1	7.95	0.49	5 100		43.5	45.0	71.5	1.5	0.25	2.48	3.84	2.60	0.675
40	80	23	1.1	19.2	6.50	0.41	5 000	2208 2RS 2308 2RS	47	48.1	73	1	0.22	2.83	4.38	2.97	0.505
	90	33	1.5	29.6	9.80	0.61	4 600		48.5	49.6	81.5	1.5	0.25	2.57	3.98	2.69	0.925
45	85	23	1.1	21.8	7.35	0.46	4 600	2209 2RS 2309 2RS	52	52.4	78	1	0.21	2.94	4.56	3.09	0.545
	100	36	1.5	38.1	12.9	0.80	4 100		53.5	56.6	91.5	1.5	0.25	2.56	3.95	2.68	1.23
50	90	23	1.1	22.7	8.10	0.51	4 300	2210 2RS 2310 2RS	56.5	56.5	83	1	0.21	3.07	4.76	3.22	0.590
	110	40	2	43.4	14.2	0.89	3 700		60	62.5	100	2	0.23	2.70	4.17	2.83	1.64
55	100	25	1.5	26.8	10.0	0.63	3 900	2211 2RS	63.5	63.5	91.5	1.5	0.20	3.19	4.94	3.34	0.810

[Remark] Standard cage types used for the above bearings are described earlier in this section.

Self-aligning ball bearings
extended inner ring type

d 20 ~ 60 mm

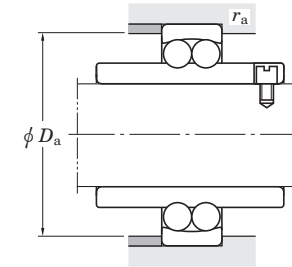
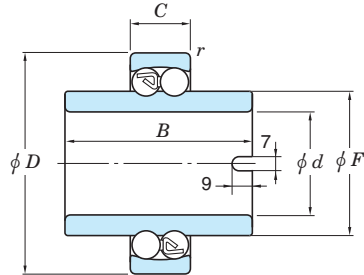

d	Boundary dimensions (mm)					Basic load ratings (kN)		Fatigue load limit (kN) C_u	Limiting speeds (min^{-1})		Bearing No.	Mounting dimensions (mm)		Constant e	Axial load factors			(Refer.) Mass (kg)
	D	B	C	F	$r_{\text{min.}}$	C_r	C_{0r}		Grease lub.	Oil lub.		D_a max.	r_a max.		Y_1	Y_2	Y_0	
20	47	40	14	29.2	1	9.90	2.65	0.16	14 000	17 000	11204 11304	42	1	0.29	2.16	3.35	2.27	0.191
	52	44	15	31.5	1.1	12.4	3.35	0.21	13 000	15 000		45.5	1	0.30	2.12	3.28	2.22	0.266
25	52	44	15	33.3	1	12.1	3.30	0.21	12 000	14 000	11205 11305	47	1	0.28	2.28	3.52	2.39	0.226
	62	48	17	38	1.1	18.0	5.05	0.32	9 900	12 000		55.5	1	0.27	2.31	3.57	2.42	0.445
30	62	48	16	40.1	1	15.6	4.70	0.29	9 900	12 000	11206 11306	57	1	0.25	2.55	3.94	2.67	0.360
	72	52	19	45	1.1	21.3	6.30	0.40	8 700	11 000		65.5	1	0.26	2.40	3.72	2.52	0.614
35	72	52	17	47.7	1.1	15.8	5.15	0.32	8 500	10 000	11207 11307	65.5	1	0.23	2.71	4.20	2.84	0.556
	80	56	21	51.7	1.5	25.1	7.95	0.49	7 600	9 300		72	1.5	0.25	2.48	3.84	2.60	0.821
40	80	56	18	54	1.1	19.2	6.50	0.41	7 500	9 200	11208 11308	73.5	1	0.22	2.83	4.38	2.97	0.733
	90	58	23	57.7	1.5	29.6	9.80	0.61	6 900	8 400		82	1.5	0.25	2.57	3.98	2.69	1.09
45	85	58	19	57.7	1.1	21.8	7.35	0.46	7 000	8 500	11209 11309	78.5	1	0.21	2.94	4.56	3.09	0.793
	100	60	25	63.9	1.5	38.1	12.9	0.80	6 100	7 500		92	1.5	0.25	2.56	3.95	2.68	1.40
50	90	58	20	62.7	1.1	22.7	8.10	0.51	6 500	7 900	11210 11310	83.5	1	0.21	3.07	4.76	3.22	0.875
	110	62	27	70.3	2	43.4	14.2	0.89	5 600	6 800		102	2	0.23	2.70	4.17	2.83	1.74
55	100	60	21	70.3	1.5	26.8	10.0	0.63	5 800	7 100	11211	93.5	1.5	0.20	3.19	4.94	3.34	1.16
60	110	62	22	78	1.5	30.2	11.6	0.73	5 200	6 400	11212	103.5	1.5	0.19	3.37	5.22	3.53	1.52

Adapter assemblies for self-aligning ball bearings

d_1 17 ~ (45) mm

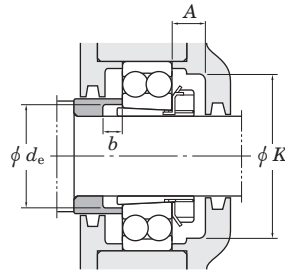
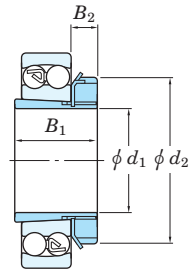

d_1 (45) ~ 80 mm

Boundary dimensions (mm)				Brg. bore d (mm)	Designations Bearing + adapter ass'y	Mounting dimensions (mm)				Mass Brg.+adapter ass'y (kg)	(Refer.)	
d_1	B_1	d_2	B_2			A min.	K min.	d_e min.	b min.		Adapter sleeve No.	Locknut No.
17	24	32	7	20	1204K+H204X	—	—	23	5	0.162	A204X	AN04
	28	32	7	20	2204K+H304X	—	—	24	5	0.185	A304X	AN04
	28	32	7	20	1304K+H304X	—	—	24	8	0.210	A304X	AN04
	31	32	7	20	2304K+H2304X	—	—	24	5	0.257	A2304X	AN04
20	26	38	8	25	1205K+H205X	15	45	28	5	0.218	A205X	AN05
	29	38	8	25	2205K+H305X	15	45	29	5	0.243	A305X	AN05
	29	38	8	25	1305K+H305X	15	45	29	6	0.337	A305X	AN05
	35	38	8	25	2305K+H2305X	15	45	29	5	0.424	A2305X	AN05
25	27	45	8	30	1206K+H206X	15	50	33	5	0.320	A206X	AN06
	31	45	8	30	2206K+H306X	15	50	34	5	0.368	A306X	AN06
	31	45	8	30	1306K+H306X	15	50	34	6	0.495	A306X	AN06
	38	45	8	30	2306K+H2306X	15	50	35	5	0.620	A2306X	AN06
30	29	52	9	35	1207K+H207X	17	58	38	5	0.462	A207X	AN07
	35	52	9	35	2207K+H307X	17	58	39	5	0.557	A307X	AN07
	35	52	9	35	1307K+H307X	17	58	39	7	0.663	A307X	AN07
	43	52	9	35	2307K+H2307X	17	58	40	5	0.843	A2307X	AN07
35	31	58	10	40	1208K+H208X	17	65	44	5	0.597	A208X	AN08
	36	58	10	40	2208K+H308X	17	65	44	5	0.696	A308X	AN08
	36	58	10	40	1308K+H308X	17	65	44	5	0.906	A308X	AN08
	46	58	10	40	2308K+H2308X	17	65	45	5	1.14	A2308X	AN08
40	33	65	11	45	1209K+H209X	17	72	49	5	0.701	A209X	AN09
	39	65	11	45	2209K+H309X	17	72	49	8	0.798	A309X	AN09
	39	65	11	45	1309K+H309X	17	72	49	5	1.21	A309X	AN09
	50	65	11	45	2309K+H2309X	17	72	50	5	1.51	A2309X	AN09
45	35	70	12	50	1210K+H210X	19	76	53	5	0.804	A210X	AN10
	42	70	12	50	2210K+H310X	19	76	54	10	0.896	A310X	AN10

Boundary dimensions (mm)				Brg. bore d (mm)	Designations Bearing + adapter ass'y	Mounting dimensions (mm)				Mass Brg.+adapter ass'y (kg)	(Refer.)	
d_1	B_1	d_2	B_2			A min.	K min.	d_e min.	b min.		Adapter sleeve No.	Locknut No.
45	42	70	12	50	1310K+H310X	19	76	54	5	1.51	A310X	AN10
	55	70	12	50	2310K+H2310X	19	76	56	5	1.98	A2310X	AN10
50	37	75	12	55	1211K+H211X	19	85	60	6	1.02	A211X	AN11
	45	75	12	55	2211K+H311X	19	85	60	11	1.16	A311X	AN11
	45	75	12	55	1311K+H311X	19	85	60	6	1.93	A311X	AN11
	59	75	12	55	2311K+H2311X	19	85	61	6	2.50	A2311X	AN11
55	38	80	13	60	1212K+H212X	20	90	61	5	1.25	A212X	AN12
	47	80	13	60	2212K+H312X	20	90	65	9	1.49	A312X	AN12
	47	80	13	60	1312K+H312X	20	90	65	5	2.35	A312X	AN12
	62	80	13	60	2312K+H2312X	20	90	66	5	3.04	A2312X	AN12
60	40	85	14	65	1213K+H213X	21	96	70	5	1.56	A213X	AN13
	50	85	14	65	2213K+H313X	21	96	70	8	1.92	A313X	AN13
	50	85	14	65	1313K+H313X	21	96	70	5	2.90	A313X	AN13
65	43	98	15	75	1215K+H215X	23	110	80	5	2.09	A215X	AN15
	55	98	15	75	1315K+H315X	23	110	80	5	4.40	A315X	AN15
70	46	105	17	80	1216K+H216X	25	120	85	5	2.57	A216X	AN16
	59	105	17	80	1316K+H316X	25	120	86	5	5.21	A316X	AN16
75	50	110	18	85	1217K+H217X	27	128	90	6	3.11	A217X	AN17
	63	110	18	85	1317K+H317X	27	128	91	6	6.15	A317X	AN17
80	52	120	18	90	1218K+H218X	28	139	95	6	3.75	A218X	AN18
	65	120	18	90	1318K+H318X	28	139	96	6	7.16	A318X	AN18

Cylindrical roller bearings

Cylindrical roller bearings feature high radial load capacity because the rollers and raceway are in linear contact. These bearings are suitable for applications that involve heavy radial and impact loading.

They are also appropriate for high-speed applications in that they can be machined very accurately due to their structure.

Having a separable inner ring or outer ring, these bearings can be mounted and dismantled easily.

■ Single-row cylindrical roller bearings

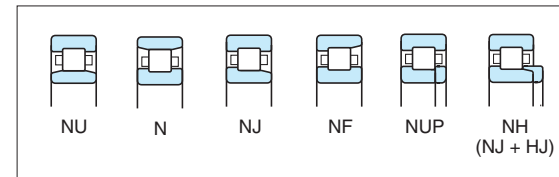

- The NU and N types exhibit their best performance when used as free side bearings since they adjust to the shaft's axial movement, to a certain extent, relative to the housing position.
- The NJ and NF types carry axial load in one direction, while the NUP and NH types can carry a certain degree of axial load in both directions.
- Type R cylindrical roller bearings feature enhanced load rating compared with standard series, though both have equal dimensions. This is because type R bearings have different internal design. They are identified by supplementary code "R".

■ Double-row cylindrical roller bearings

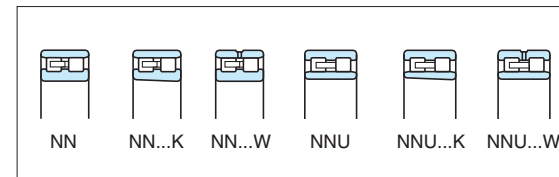

- Double-row cylindrical roller bearings come in two types : with a cylindrical bore, and with a tapered bore. As for those with a tapered bore, the specified amount of clearance can be obtained by adjusting the press-in distance. Some bearings have lubrication holes and lubrication grooves on the outer ring. They are identified by supplementary code "W".
- These bearings can accommodate high radial loads, and are often used on machine tool spindles.

Single-row cylindrical roller bearings



Bore diameter **20 – 460 mm**



Thrust collar

Bore diameter **20 – 320 mm**

Double-row cylindrical roller bearings

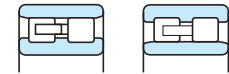

NN

NNU

Bore diameter **25 – 480 mm**



Boundary dimensions	The dimensions of standard series are as specified in JIS B 1512.																																																												
Tolerances	As specified in JIS B 1514-1 (refer to Table 7-3 on pp. A 60 – A 63).																																																												
	Tolerances of roller set bore diameter F_w and roller set outside diameter E_w of interchangeable bearings are as follows : Unit : μm																																																												
	<table border="1"> <thead> <tr> <th colspan="2">Nominal bore diameter d (mm)</th> <th colspan="2">Δ_{Fw} Roller set bore diameter deviation</th> <th colspan="2">Δ_{Ew} Roller set outside diameter deviation</th> </tr> <tr> <th>over</th> <th>up to</th> <th>upper</th> <th>lower</th> <th>upper</th> <th>lower</th> </tr> </thead> <tbody> <tr> <td>–</td> <td>20</td> <td>+ 10</td> <td>0</td> <td>0</td> <td>– 10</td> </tr> <tr> <td>20</td> <td>50</td> <td>+ 15</td> <td>0</td> <td>0</td> <td>– 15</td> </tr> <tr> <td>50</td> <td>120</td> <td>+ 20</td> <td>0</td> <td>0</td> <td>– 20</td> </tr> <tr> <td>120</td> <td>200</td> <td>+ 25</td> <td>0</td> <td>0</td> <td>– 25</td> </tr> <tr> <td>200</td> <td>250</td> <td>+ 30</td> <td>0</td> <td>0</td> <td>– 30</td> </tr> <tr> <td>250</td> <td>315</td> <td>+ 35</td> <td>0</td> <td>0</td> <td>– 35</td> </tr> <tr> <td>315</td> <td>400</td> <td>+ 40</td> <td>0</td> <td>0</td> <td>– 40</td> </tr> <tr> <td>400</td> <td>500</td> <td>+ 45</td> <td>0</td> <td>–</td> <td>–</td> </tr> </tbody> </table>	Nominal bore diameter d (mm)		Δ_{Fw} Roller set bore diameter deviation		Δ_{Ew} Roller set outside diameter deviation		over	up to	upper	lower	upper	lower	–	20	+ 10	0	0	– 10	20	50	+ 15	0	0	– 15	50	120	+ 20	0	0	– 20	120	200	+ 25	0	0	– 25	200	250	+ 30	0	0	– 30	250	315	+ 35	0	0	– 35	315	400	+ 40	0	0	– 40	400	500	+ 45	0	–	–
	Nominal bore diameter d (mm)		Δ_{Fw} Roller set bore diameter deviation		Δ_{Ew} Roller set outside diameter deviation																																																								
over	up to	upper	lower	upper	lower																																																								
–	20	+ 10	0	0	– 10																																																								
20	50	+ 15	0	0	– 15																																																								
50	120	+ 20	0	0	– 20																																																								
120	200	+ 25	0	0	– 25																																																								
200	250	+ 30	0	0	– 30																																																								
250	315	+ 35	0	0	– 35																																																								
315	400	+ 40	0	0	– 40																																																								
400	500	+ 45	0	–	–																																																								
[Remark] Interchangeable bearings have an inner ring with rollers that can be matched with the outer ring, or an outer ring with rollers that can be matched with the inner ring, without affecting performance in the bearing that has the same bearing number in one category.																																																													
Tapered bore tolerance and allowable values of high precision double-row cylindrical roller bearings (classes 5 and 4) are provided in JTEKT standards (refer to Table 7-11 on p. A 76).																																																													
Radial internal clearance	· Cylindrical bore and tapered bore bearings(refer to Table 10-8 on pp. A 106, 107.) · Motor bearings.....(refer to Table 10-7 on p. A 105.)																																																												
Recommended fits	Refer to Table 9-4 on pp. A 91, 92.																																																												
Standard cages	<ul style="list-style-type: none"> ■ For single-row cylindrical roller bearings : <ul style="list-style-type: none"> · Pressed cage (supplementary code : //) · Synthetic resin molded cage (supplementary code : FG) · Copper alloy machined cage (supplementary code : FY) (Copper alloy machined cages without rivets (LY) are also used for some special purposes.) ■ For double-row cylindrical roller bearings : <ul style="list-style-type: none"> · Prong type copper alloy machined cage (supplementary code : FY) · Separable prong type copper alloy machined cage (supplementary code : FW)for class 5 or higher precision bearings <p style="margin-left: 100px;">} For application range, refer to Table 1.</p>																																																												

Allowable misalignment	Allowable misalignment of single-row cylindrical roller bearings depends on bearing type and specification. General values are as follows : 1) When P_r/C_r is approx. 8% under load of normal use0.000 6 rad (2') – 0.000 9 rad (3') 2) When P_r/C_r is approx. 5% under load lighter than 1)0.001 2 rad (4') When very large allowable misalignment is required, consult with JTEKT.
Equivalent radial load	Dynamic equivalent radial load $P_r = F_r$ Static equivalent radial load $P_{0r} = F_r$
Allowable axial load	Cylindrical roller bearings with ribs, including loose rib and thrust collar, on both inner and outer rings accommodate axial load to a certain extent. (NJ and NF types accommodate load applied in one direction : NUP and NH in both directions.) For calculation of allowable axial load, refer to p. A 44.

Table 1 Application of standard cages

Bearing series	Pressed cage	Synthetic resin molded cage	Machined cage
NU, NUP 10	—	—	1005 – 1092
N, NF 2	204 – 220	—	204 – 264
NU, NJ, NUP 2	—	—	244 – 264
NU, NJ, NUP 2 R	—	204R – 213R	214R – 240R
NU, NJ, NUP 22	2204 – 2220	—	2204 – 2252
NU, NJ, NUP 22 R	2204R – 2220R	—	2204R – 2240R
NU 32	—	—	3206 – 3252
N, NF 3	304 – 320	—	304 – 348
NU, NJ, NUP 3	—	—	334 – 348
NU, NJ, NUP 3 R	—	304R – 314R	315R – 332R
NU, NJ, NUP 23	2304 – 2320	—	2304 – 2340
NU, NJ, NUP 23 R	2304R – 2320R	—	2304R – 2332R
NU 33	—	—	3306 – 3352
NU, NJ, NUP, NF 4	406 – 420	—	406 – 430

Single-row cylindrical roller bearings

d 20 ~ (30) mm

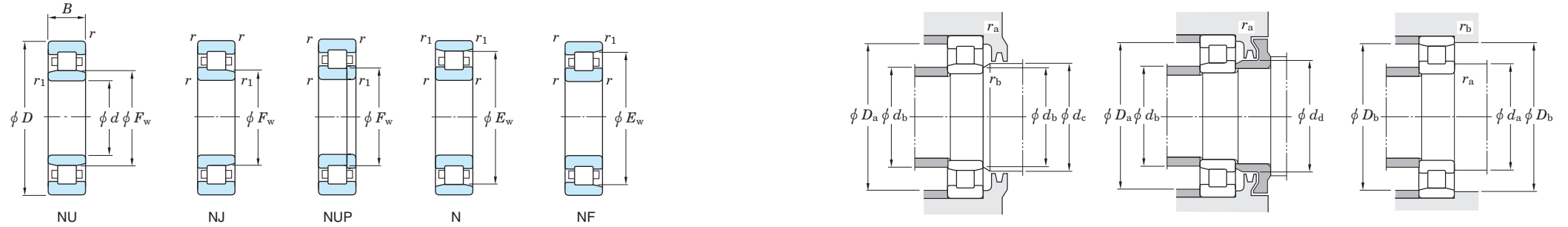

d	Boundary dimensions (mm)							Basic load ratings (kN)		Fatigue load limit (kN) Cu	Limiting speeds (min ⁻¹)		Bearing No.					Mounting dimensions (mm)								(Refer.) Mass NU (kg)	
	D	B	r min.	r1 min.	Fw	Ew	Cr	C0r	Grease lub.		Oil lub.	NU	NJ	NUP	N	NF	da min.	db min.	db max.	dc min.	dd min.	Da max.	Db max.	ra min.	ra max.		rb min.
20	47	14	1	0.6	—	40	19.3	12.7	1.45	15 000	18 000	—	—	—	25	—	—	—	32	42	43	42	1	0.6	(0.108)		
	47	14	1	0.6	26.5	—	32.2	22.6	3.05	15 000	18 000	NU204R	NJ204R	NUP204R	—	—	25	24	26	29	32	42	—	—	1	0.6	0.112
	47	18	1	0.6	27	—	27.8	18.4	2.70	13 000	18 000	NU2204	NJ2204	NUP2204	—	—	25	24	26	29	32	42	—	—	1	0.6	0.146
	47	18	1	0.6	26.5	—	38.3	28.3	3.60	13 000	18 000	NU2204R	NJ2204R	NUP2204R	—	—	25	24	26	29	32	42	—	—	1	0.6	0.146
	52	15	1.1	0.6	—	44.5	28.9	19.2	2.50	12 000	16 000	—	—	—	N304	NF304	26.5	—	—	—	33	45.5	48	45.5	1	0.6	(0.147)
	52	15	1.1	0.6	27.5	—	39.4	26.9	3.75	12 000	16 000	NU304R	NJ304R	NUP304R	—	—	26.5	24	27	30	33	45.5	—	—	1	0.6	0.153
	52	21	1.1	0.6	28.5	—	38.0	30.2	3.60	11 000	16 000	NU2304	NJ2304	NUP2304	—	—	26.5	24	27	30	33	45.5	—	—	1	0.6	0.212
	52	21	1.1	0.6	27.5	—	52.5	38.8	5.40	11 000	16 000	NU2304R	NJ2304R	NUP2304R	—	—	26.5	24	27	30	33	45.5	—	—	1	1	0.215
	25	47	12	0.6	0.3	30.5	—	17.8	13.1	2.25	15 000	18 000	NU1005	—	NUP1005	—	—	29	27	30	32	—	43	—	—	0.6	0.3
52		15	1	0.6	—	45	22.1	15.7	1.80	13 000	16 000	—	—	—	N205	NF205	30	—	—	—	37	47	48	47	1	0.6	(0.132)
52		15	1	0.6	31.5	—	36.7	27.7	3.75	13 000	15 000	NU205R	NJ205R	NUP205R	—	—	30	29	31	34	37	47	—	—	1	0.6	0.138
52		18	1	0.6	32	—	29.6	22.8	3.05	12 000	16 000	NU2205	NJ2205	NUP2205	—	—	30	29	31	34	37	47	—	—	1	0.6	0.163
52		18	1	0.6	31.5	—	43.6	34.6	4.40	12 000	15 000	NU2205R	NJ2205R	NUP2205R	—	—	30	29	31	34	37	47	—	—	1	0.6	0.166
62		17	1.1	1.1	—	53	36.6	25.2	3.45	10 000	14 000	—	—	—	N305	NF305	31.5	—	—	—	40	55.5	55.5	55	1	1	(0.235)
62		17	1.1	1.1	34	—	51.9	37.4	4.85	10 000	14 000	NU305R	NJ305R	NUP305R	—	—	31.5	31.5	33	37	40	55.5	—	—	1	1	0.243
62		24	1.1	1.1	35	—	53.4	40.9	5.70	9 100	14 000	NU2305	NJ2305	NUP2305	—	—	31.5	31.5	33	37	40	55.5	—	—	1	1	0.340
62		24	1.1	1.1	34	—	71.2	56.1	7.50	9 100	14 000	NU2305R	NJ2305R	NUP2305R	—	—	31.5	31.5	33	37	40	55.5	—	—	1	1	0.350
30	55	13	1	0.6	36.5	—	23.4	18.4	2.05	13 000	15 000	NU1006	—	NUP1006	—	—	35	34	35	38	—	50	—	—	1	0.6	0.121
	62	16	1	0.6	—	53.5	31.1	21.5	2.95	11 000	13 000	—	—	—	N206	NF206	35	—	—	—	44	57	58	56	1	0.6	(0.206)
	62	16	1	0.6	37.5	—	48.9	37.4	5.25	11 000	13 000	NU206R	NJ206R	NUP206R	—	—	35	34	37	40	44	57	—	—	1	0.6	0.209
	62	20	1	0.6	38.5	—	41.0	33.1	4.20	9 800	13 000	NU2206	NJ2206	NUP2206	—	—	35	34	37	40	44	57	—	—	1	0.6	0.262
	62	20	1	0.6	37.5	—	61.2	49.8	6.80	9 700	13 000	NU2206R	NJ2206R	NUP2206R	—	—	35	34	37	40	44	57	—	—	1	0.6	0.262
	62	23.8	1	1	38.5	—	53.3	46.4	5.95	8 700	13 000	NU3206	—	—	—	—	35	35	37	40	—	57	—	—	1	0.6	0.343
	72	19	1.1	1.1	—	62	48.3	35.2	5.00	8 700	12 000	—	—	—	N306	NF306	36.5	—	—	—	48	65.5	65.5	64	1	1	(0.353)
	72	19	1.1	1.1	40.5	—	66.5	50.2	6.80	8 700	12 000	NU306R	NJ306R	NUP306R	—	—	36.5	36.5	40	44	48	65.5	—	—	1	1	0.361
	72	27	1.1	1.1	42	—	64.3	50.8	7.15	7 700	12 000	NU2306	NJ2306	NUP2306	—	—	36.5	36.5	40	44	48	65.5	—	—	1	1	0.500
	72	27	1.1	1.1	40.5	—	93.3	77.6	10.1	7 800	12 000	NU2306R	NJ2306R	NUP2306R	—	—	36.5	36.5	40	44	48	65.5	—	—	1	1	0.534

[Remarks] 1) Standard cage types used for the above bearings are shown in Table 1 earlier in this section. Please note that basic load ratings and limiting speeds shown above indicate the value applicable to machined cage. Consult JTEKT about bearings with pressed cage, since they may be different from bearings with machined cage in values above.

2) Bearing numbers of NU and NJ type bearings with mounted thrust collar (refer to specification table shown after this specification table) are NUJ and NH.

Single-row cylindrical roller bearings

d (30) ~ (45) mm

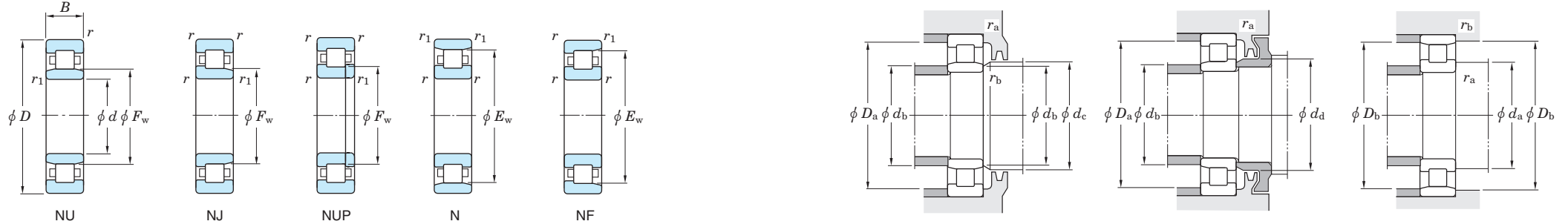

Boundary dimensions (mm)			Basic load ratings (kN)		Fatigue load limit (kN) C_u	Limiting speeds (min^{-1}) Grease lub. Oil lub.	Bearing No.					Mounting dimensions (mm)								(Refer.) Mass NU (N) (kg)							
d	D	B	r min.	r_1 min.			F_w	E_w	C_r	C_{0r}	NU	NJ	NUP	N	NF	d_a min.	d_b min.	d_b max.	d_c min.		d_d min.	D_a max.	D_b max.	r_a min.	r_b max.		
30	72	30.2	1.1	1.1	42	—	86.4	74.3	9.95	7 700	12 000	NU3306	—	—	—	—	—	—	65.5	—	—	1	1	0.650			
	90	23	1.5	1.5	45	73	78.3	55.0	7.95	7 600	10 000	NU406	NJ406	NUP406	N406	NF406	36.5	36.5	40	44	52	82	82	74	1.5	1.5	0.753
35	62	14	1	0.6	42	—	28.3	23.2	2.65	11 000	13 000	NU1007	—	NUP1007	—	—	—	—	57	—	—	1	0.5	0.182			
	72	17	1.1	0.6	—	61.8	44.6	31.5	4.70	9 500	11 000	—	—	—	N207	NF207	41.5	—	—	50	65.5	68	64	1	0.6	(0.293)	
	72	17	1.1	0.6	44	—	62.9	50.2	6.55	9 300	11 000	NU207R	NJ207R	NUP207R	—	—	—	50	65.5	—	—	1	0.6	0.306			
	72	23	1.1	0.6	43.8	—	61.3	51.2	7.15	8 500	11 000	NU2207	NJ2207	NUP2207	—	—	—	50	65.5	—	—	1	0.6	0.402			
	72	23	1.1	0.6	44	—	77.1	65.3	9.20	8 300	11 000	NU2207R	NJ2207R	NUP2207R	—	—	—	50	65.5	—	—	1	0.6	0.404			
	72	27	1.1	1.1	43.8	—	68.5	59.1	7.90	7 600	11 000	NU3207	—	—	—	—	—	—	65.5	—	—	1	0.6	0.524			
	80	21	1.5	1.1	—	68.2	62.0	46.9	6.20	7 900	10 000	—	—	—	N307	NF307	43	—	—	53	72	73.5	71	1.5	1	(0.477)	
	80	21	1.5	1.1	46.2	—	83.3	65.4	9.35	7 700	10 000	NU307R	NJ307R	NUP307R	—	—	—	53	72	—	—	1.5	1	0.482			
	80	31	1.5	1.1	46.2	—	75.5	65.7	7.95	7 000	10 000	NU2307	NJ2307	NUP2307	—	—	—	53	72	—	—	1.5	1	0.696			
	80	31	1.5	1.1	46.2	—	116	101	15.0	6 900	10 000	NU2307R	NJ2307R	NUP2307R	—	—	—	53	72	—	—	1.5	1	0.729			
	80	34.9	1.5	1.5	46.2	—	102	89.1	12.0	7 000	10 000	NU3307	—	—	—	—	—	—	72	—	—	—	1.5	1	0.908		
	100	25	1.5	1.5	53	83	94.1	68.9	9.25	6 600	8 800	NU407	NJ407	NUP407	N407	NF407	43	43	45	48	61	92	92	84	1.5	1.5	1.02
	40	68	15	1	0.6	47	—	31.2	25.7	3.10	10 000	12 000	NU1008	—	NUP1008	—	—	—	—	63	—	—	1	0.6	0.223		
80		18	1.1	1.1	—	70	54.7	42.9	6.15	8 300	10 000	—	—	—	N208	NF208	46.5	—	—	56	73.5	73.5	72	1	1	(0.374)	
80		18	1.1	1.1	49.5	—	69.6	55.4	7.35	8 300	9 900	NU208R	NJ208R	NUP208R	—	—	—	56	73.5	—	—	1	1	0.384			
80		23	1.1	1.1	50	—	72.8	62.0	8.75	7 500	10 000	NU2208	NJ2208	NUP2208	—	—	—	56	73.5	—	—	1	1	0.490			
80		23	1.1	1.1	49.5	—	90.5	77.6	10.3	7 400	9 900	NU2208R	NJ2208R	NUP2208R	—	—	—	56	73.5	—	—	1	1	0.490			
80		30.2	1.1	1.1	50	—	97.8	90.6	12.2	6 700	10 000	NU3208	—	—	—	—	—	—	73.5	—	—	—	1	1	0.711		
90		23	1.5	1.5	—	77.5	73.4	56.9	7.85	6 900	9 100	—	—	—	N308	NF308	48	—	—	60	82	82	80	1.5	1.5	(0.646)	
90		23	1.5	1.5	52	—	104	81.5	11.0	6 800	9 100	NU308R	NJ308R	NUP308R	—	—	—	60	82	—	—	1.5	1.5	0.664			
90		33	1.5	1.5	53.5	—	103	88.0	11.6	6 100	9 100	NU2308	NJ2308	NUP2308	—	—	—	60	82	—	—	1.5	1.5	0.956			
90		33	1.5	1.5	52	—	143	122	18.4	6 100	9 100	NU2308R	NJ2308R	NUP2308R	—	—	—	60	82	—	—	1.5	1.5	0.962			
90		36.5	1.5	1.5	53.5	—	130	119	17.6	6 100	9 100	NU3308	—	—	—	—	—	—	82	—	—	—	1.5	1.5	1.19		
110		27	2	2	58	92	120	89.1	12.6	6 000	8 000	NU408	NJ408	NUP408	N408	NF408	49	49	57	60	67	101	101	93	2	2	1.30
45		75	16	1	0.6	52.5	—	38.9	33.8	4.30	9 200	11 000	NU1009	—	NUP1009	—	—	—	—	70	—	—	1	0.6	0.289		

[Remarks] 1) Standard cage types used for the above bearings are shown in Table 1 earlier in this section. Please note that basic load ratings and limiting speeds shown above indicate the value applicable to machined cage. Consult JTEKT about bearings with pressed cage, since they may be different from bearings with machined cage in values above.

2) Bearing numbers of NU and NJ type bearings with mounted thrust collar (refer to specification table shown after this specification table) are NUJ and NH.

Single-row cylindrical roller bearings

d (45) ~ (55) mm

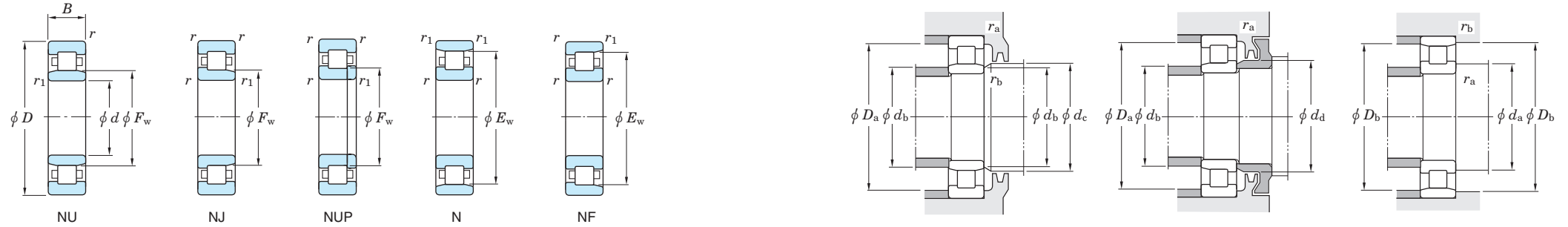

Boundary dimensions (mm)		Basic load ratings (kN)		Fatigue load limit (kN) C_u	Limiting speeds (min^{-1})		Bearing No.					Mounting dimensions (mm)								Mass NU (kg)			
d	D	C_r	C_{0r}		Grease lub.	Oil lub.	NU	NJ	NUP	N	NF	d_a min.	d_b min.	d_b max.	d_c min.	d_d min.	D_a max.	D_b max.	r_a min.		r_b max.		
45	85	19	57.6	46.9	6.70	7 700	9 200	—	—	—	N209	NF209	51.5	—	—	—	61	78.5	78.5	77	1	1	(0.427)
	85	19	78.9	66.4	9.05	7 600	9 200	NU209R	NJ209R	NUP209R	—	—	51.5	51.5	54	57	61	78.5	—	—	1	1	0.439
	85	23	76.6	67.8	9.60	6 900	9 200	NU2209	NJ2209	NUP2209	—	—	51.5	51.5	54	57	61	78.5	—	—	1	1	0.536
	85	23	95.1	84.6	11.2	6 900	9 200	NU2209R	NJ2209R	NUP2209R	—	—	51.5	51.5	54	57	61	78.5	—	—	1	1	0.536
	85	30.2	103	99.0	13.3	6 100	9 200	NU3209	—	—	—	—	51.5	51.5	54	57	—	78.5	—	—	1	1	0.770
	100	25	98.5	77.5	11.3	6 200	8 300	—	—	—	N309	NF309	53	—	—	—	66	92	92	89	1.5	1.5	(0.865)
	100	25	122	98.3	13.5	6 100	8 200	NU309R	NJ309R	NUP309R	—	—	53	53	57	60	66	92	—	—	1.5	1.5	0.909
	100	36	124	113	14.3	5 500	8 300	NU2309	NJ2309	NUP2309	—	—	53	53	57	60	66	92	—	—	1.5	1.5	1.25
	100	36	172	153	23.0	5 400	8 200	NU2309R	NJ2309R	NUP2309R	—	—	53	53	57	60	66	92	—	—	1.5	1.5	1.32
	100	39.7	164	149	22.6	5 500	8 300	NU3309	—	—	—	—	53	53	57	60	—	92	—	—	1.5	1.5	1.59
	120	29	134	112	13.8	5 400	7 200	NU409	NJ409	NUP409	N409	NF409	54	54	63	66	74	111	111	102	2	2	1.64
	50	80	16	42.2	36.8	4.80	8 400	9 900	NU1010	—	NUP1010	—	—	55	54	57	59	—	75	—	—	1	0.6
90		20	60.3	51.0	7.30	7 100	8 500	—	—	—	N210	NF210	56.5	—	—	—	67	83.5	83.5	82	1	1	(0.479)
90		20	82.5	71.9	9.85	7 100	8 500	NU210R	NJ210R	NUP210R	—	—	56.5	56.5	58	62	67	83.5	—	—	1	1	0.497
90		23	80.3	73.6	10.4	6 400	8 500	NU2210	NJ2210	NUP2210	—	—	56.5	56.5	58	62	67	83.5	—	—	1	1	0.580
90		23	99.5	91.5	12.1	6 400	8 500	NU2210R	NJ2210R	NUP2210R	—	—	56.5	56.5	58	62	67	83.5	—	—	1	1	0.580
90		30.2	108	108	14.5	5 700	8 500	NU3210	—	—	—	—	56.5	56.5	58	62	—	83.5	—	—	1	1	0.829
110		27	109	93.4	11.7	5 600	7 500	—	—	—	N310	NF310	59	—	—	—	73	101	101	98	2	2	(1.15)
110		27	138	113	16.0	5 500	7 400	NU310R	NJ310R	NUP310R	—	—	59	59	63	67	73	101	—	—	2	2	1.15
110		40	151	142	20.1	5 000	7 500	NU2310	NJ2310	NUP2310	—	—	59	59	63	67	73	101	—	—	2	2	1.69
110		40	203	187	28.6	4 900	7 400	NU2310R	NJ2310R	NUP2310R	—	—	59	59	63	67	73	101	—	—	2	2	1.76
110		44.4	195	183	27.3	5 000	7 500	NU3310	—	—	—	—	59	59	63	67	—	101	—	—	2	2	2.14
130		31	161	136	17.4	4 900	6 600	NU410	NJ410	NUP410	N410	NF410	61	61	69	73	81	119	119	112	2	2	2.01
55	90	18	47.1	43.8	5.75	7 600	8 900	NU1011	—	NUP1011	—	—	61.5	60	63	66	—	83.5	—	—	1	1	0.445
	100	21	72.5	62.3	8.30	6 400	7 700	—	—	—	N211	NF211	63	—	—	—	73	92	93.5	91	1.5	1	(0.633)
	100	21	108	98.7	14.2	6 400	7 700	NU211R	NJ211R	NUP211R	—	—	63	61.5	65	68	73	92	—	—	1.5	1	0.650
	100	25	94.2	87.2	11.6	5 800	7 700	NU2211	NJ2211	NUP2211	—	—	63	61.5	65	68	73	92	—	—	1.5	1	0.780

[Remarks] 1) Standard cage types used for the above bearings are shown in Table 1 earlier in this section. Please note that basic load ratings and limiting speeds shown above indicate the value applicable to machined cage. Consult JTEKT about bearings with pressed cage, since they may be different from bearings with machined cage in values above.

2) Bearing numbers of NU and NJ type bearings with mounted thrust collar (refer to specification table shown after this specification table) are NUJ and NH.

Single-row cylindrical roller bearings

d (55) ~ (65) mm

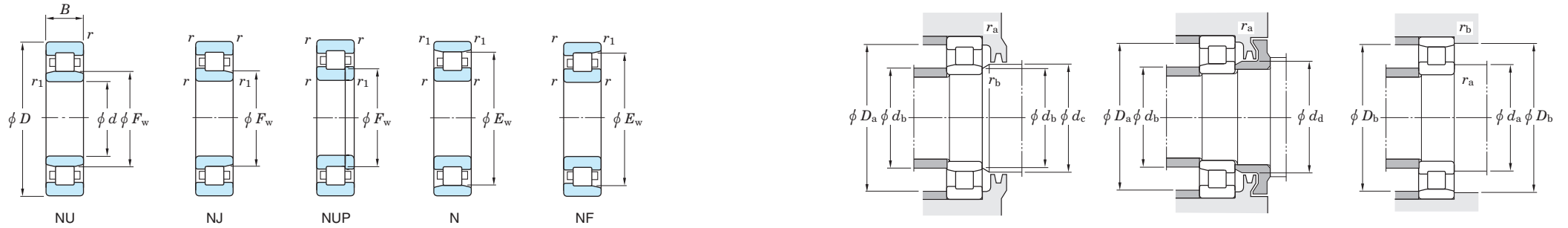

Boundary dimensions (mm)								Basic load ratings (kN)		Fatigue load limit (kN)	Limiting speeds (min ⁻¹)		Bearing No.					Mounting dimensions (mm)							(Refer.) Mass NU (kg)		
d	D	B	r min.	r ₁ min.	F _w	E _w	C _r	C _{0r}	C _u	Grease lub.	Oil lub.	NU	NJ	NUP	N	NF	d _a min.	d _b min.	d _b max.	d _c min.	d _d min.	D _a max.	D _b max.	r _a min.	r _b max.		
55	100	25	1.5	1.1	66	—	127	122	16.9	5 800	7 700	NU2211R	NJ2211R	NUP2211R	—	—	63	61.5	65	68	73	92	—	—	1.5	1	0.806
	100	33.3	1.5	1.5	66.5	—	119	118	16.1	5 100	7 700	NU3211	—	—	—	—	63	63	65	68	—	92	—	—	1.5	1	1.14
	120	29	2	2	—	104.5	138	111	15.8	5 100	6 800	—	—	—	N311	NF311	64	—	—	—	80	111	111	107	2	2	(1.44)
	120	29	2	2	70.5	—	172	143	19.8	5 100	6 700	NU311R	NJ311R	NUP311R	—	—	64	64	69	72	80	111	—	—	2	2	1.50
	120	43	2	2	70.5	—	185	162	24.6	4 500	6 800	NU2311	NJ2311	NUP2311	—	—	64	64	69	72	80	111	—	—	2	2	2.10
	120	43	2	2	70.5	—	251	233	35.3	4 500	6 700	NU2311R	NJ2311R	NUP2311R	—	—	64	64	69	72	80	111	—	—	2	2	2.25
	120	49.2	2	2	70.5	—	235	220	32.8	4 500	6 800	NU3311	—	—	—	—	64	64	69	72	—	111	—	—	2	2	2.81
	140	33	2.1	2.1	77.2	117.2	174	138	19.6	4 600	6 100	NU411	NJ411	NUP411	N411	NF411	66	66	76	79	87	129	129	119	2	2	2.51
60	95	18	1.1	1	69.5	—	53.0	50.0	6.75	7 000	8 300	NU1012	—	NUP1012	—	—	66.5	65	68	71	—	88.5	—	—	1	1	0.477
	110	22	1.5	1.5	—	97.5	85.7	79.9	10.4	5 800	7 000	—	—	—	N212	NF212	68	—	—	—	80	102	102	100	1.5	1.5	(0.823)
	110	22	1.5	1.5	72	—	122	107	15.7	5 800	6 900	NU212R	NJ212R	NUP212R	—	—	68	68	71	75	80	102	—	—	1.5	1.5	0.830
	110	28	1.5	1.5	73.5	—	120	123	15.3	5 200	7 000	NU2212	NJ2212	NUP2212	—	—	68	68	71	75	80	102	—	—	1.5	1.5	1.07
	110	28	1.5	1.5	72	—	164	157	21.7	5 200	6 900	NU2212R	NJ2212R	NUP2212R	—	—	68	68	71	75	80	102	—	—	1.5	1.5	1.09
	110	36.5	1.5	1.5	73.5	—	160	167	24.7	4 700	7 000	NU3212	—	—	—	—	68	68	71	75	—	102	—	—	1.5	1.5	1.52
	130	31	2.1	2.1	—	113	155	126	17.3	4 700	6 300	—	—	—	N312	NF312	71	—	—	—	86	119	119	116	2	2	(1.83)
	130	31	2.1	2.1	77	—	187	157	22.1	4 600	6 200	NU312R	NJ312R	NUP312R	—	—	71	71	75	79	86	119	—	—	2	2	1.87
	130	46	2.1	2.1	77	—	211	188	29.4	4 200	6 300	NU2312	NJ2312	NUP2312	—	—	71	71	75	79	86	119	—	—	2	2	2.69
	130	46	2.1	2.1	77	—	278	262	39.6	4 100	6 200	NU2312R	NJ2312R	NUP2312R	—	—	71	71	75	79	86	119	—	—	2	2	2.81
	130	54	2.1	2.1	77	—	275	265	39.9	4 200	6 300	NU3312	—	—	—	—	71	71	75	79	—	119	—	—	2	2	3.61
	150	35	2.1	2.1	83	127	209	184	26.1	4 200	5 700	NU412	NJ412	NUP412	N412	NF412	71	71	82	85	94	139	139	128	2	2	3.02
65	100	18	1.1	1	74.5	—	54.4	52.9	7.15	6 600	7 800	NU1013	—	NUP1013	—	—	71.5	70	73	76	—	93.5	—	—	1	1	0.506
	120	23	1.5	1.5	—	105.6	105	94.4	13.5	5 400	6 400	—	—	—	N213	NF213	73	—	—	—	87	112	112	108	1.5	1.5	(1.05)
	120	23	1.5	1.5	78.5	—	134	119	16.1	5 300	6 400	NU213R	NJ213R	NUP213R	—	—	73	73	77	81	87	112	—	—	1.5	1.5	1.05
	120	31	1.5	1.5	79.6	—	150	149	20.6	4 800	6 400	NU2213	NJ2213	NUP2213	—	—	73	73	77	81	87	112	—	—	1.5	1.5	1.43
	120	31	1.5	1.5	78.5	—	186	181	27.7	4 800	6 400	NU2213R	NJ2213R	NUP2213R	—	—	73	73	77	81	87	112	—	—	1.5	1.5	1.45
	120	38.1	1.5	1.5	79.6	—	186	197	29.7	4 300	6 400	NU3213	—	—	—	—	73	73	77	81	—	112	—	—	1.5	1.5	1.90
	140	33	2.1	2.1	—	121.5	169	139	19.2	4 300	5 800	—	—	—	N313	NF313	76	—	—	—	93	129	129	125	2	2	(2.19)

[Remarks] 1) Standard cage types used for the above bearings are shown in Table 1 earlier in this section. Please note that basic load ratings and limiting speeds shown above indicate the value applicable to machined cage. Consult JTEKT about bearings with pressed cage, since they may be different from bearings with machined cage in values above.

2) Bearing numbers of NU and NJ type bearings with mounted thrust collar (refer to specification table shown after this specification table) are NUJ and NH.

Single-row cylindrical roller bearings

d (75) ~ (90) mm

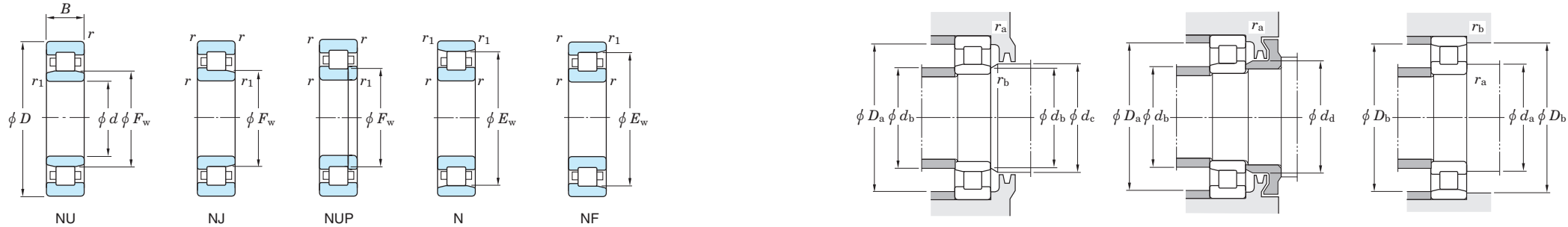

Boundary dimensions (mm)							Basic load ratings (kN)		Fatigue load limit (kN) C _u	Limiting speeds (min ⁻¹)		Bearing No.					Mounting dimensions (mm)								(Refer.) Mass NU (N) (kg)			
d	D	B	r min.	r ₁ min.	F _w	E _w	C _r	C _{0r}		Grease lub.	Oil lub.	NU	NJ	NUP	N	NF	d _a min.	d _b min.	d _b max.	d _c min.	d _d min.	D _a max.	D _b max.	r _a min.		r _b max.		
75	160	68.3	2.1	2.1	95.5	—	423	430	62.1	3 400	5 000	NU3315	—	—	—	86	86	93	97	—	149	—	—	2	2	6.86		
	190	45	3	3	104.5	160.5	328	274	40.2	3 300	4 400	NU415	NJ415	NUP415	N415	NF415	88	88	103	107	118	177	177	162	2.5	2.5	6.25	
80	125	22	1.1	1	91.5	—	87.2	86.4	11.5	5 300	6 300	NU1016	—	NUP1016	—	—	86.5	85	90	94	—	118.5	—	—	1	1	0.994	
	140	26	2	2	—	125.3	133	122	16.2	4 500	5 400	—	—	—	N216	NF216	89	—	—	—	104	131	131	128	2	2	(1.51)	
	140	26	2	2	95.3	—	174	167	23.0	4 400	5 300	NU216R	NJ216R	NUP216R	—	—	89	89	94	97	104	131	—	—	2	2	1.56	
	140	33	2	2	95.3	—	184	186	27.8	4 000	5 400	NU2216	NJ2216	NUP2216	—	—	89	89	94	97	104	131	—	—	2	2	1.96	
	140	33	2	2	95.3	—	233	243	35.8	4 000	5 300	NU2216R	NJ2216R	NUP2216R	—	—	89	89	94	97	104	131	—	—	2	2	2.03	
	140	44.4	2	2	95.3	—	238	259	37.8	3 600	5 400	NU3216	—	—	—	—	89	89	94	97	—	131	—	—	2	2	2.87	
	170	39	2.1	2.1	—	147	—	238	207	30.7	3 500	4 700	—	—	—	N316	NF316	91	—	—	—	114	159	159	151	2	2	(3.83)
	170	39	2.1	2.1	101	—	320	282	42.1	3 500	4 700	NU316R	NJ316R	NUP316R	—	—	91	91	99	105	114	159	—	—	2	2	4.00	
	170	58	2.1	2.1	103	—	343	332	46.9	3 100	4 700	NU2316	NJ2316	NUP2316	—	—	91	91	99	105	114	159	—	—	2	2	5.83	
	170	58	2.1	2.1	101	—	445	431	61.1	3 100	4 700	NU2316R	NJ2316R	NUP2316R	—	—	91	91	99	105	114	159	—	—	2	2	5.95	
	170	68.3	2.1	2.1	103	—	423	436	61.9	3 100	4 700	NU3316	—	—	—	—	91	91	99	105	—	159	—	—	2	2	7.72	
	200	48	3	3	110	170	—	374	315	45.2	3 100	4 200	NU416	NJ416	NUP416	N416	NF416	93	93	109	112	124	187	187	172	2.5	2.5	7.28
85	130	22	1.1	1	96.5	—	89.8	91.2	12.0	5 100	6 000	NU1017	—	NUP1017	—	—	91.5	90	95	99	—	123.5	—	—	1	1	1.04	
	150	28	2	2	—	133.8	151	140	18.7	4 200	5 000	—	—	—	N217	NF217	94	—	—	—	110	141	141	137	2	2	(1.90)	
	150	28	2	2	100.5	—	209	199	26.3	4 200	5 000	NU217R	NJ217R	NUP217R	—	—	94	94	99	104	110	141	—	—	2	2	1.94	
	150	36	2	2	101.8	—	212	218	31.6	3 800	5 000	NU2217	NJ2217	NUP2217	—	—	94	94	99	104	110	141	—	—	2	2	2.50	
	150	36	2	2	100.5	—	272	279	41.6	3 700	5 000	NU2217R	NJ2217R	NUP2217R	—	—	94	94	99	104	110	141	—	—	2	2	2.53	
	150	49.2	2	2	101.8	—	269	296	42.1	3 300	5 000	NU3217	—	—	—	—	94	94	99	104	—	141	—	—	2	2	3.67	
	180	41	3	3	—	156	—	281	247	35.6	3 300	4 500	—	—	—	N317	NF317	98	—	—	—	119	167	167	160	2.5	2.5	(4.52)
	180	41	3	3	108	—	364	330	48.3	3 300	4 400	NU317R	NJ317R	NUP317R	—	—	98	98	106	110	119	167	—	—	2.5	2.5	4.80	
	180	60	3	3	108	—	394	382	54.2	3 000	4 500	NU2317	NJ2317	NUP2317	—	—	98	98	106	110	119	167	—	—	2.5	2.5	6.62	
	180	60	3	3	108	—	491	485	67.7	2 900	4 400	NU2317R	NJ2317R	NUP2317R	—	—	98	98	106	110	119	167	—	—	2.5	2.5	6.98	
	180	73	3	3	108	—	499	517	71.5	3 000	4 500	NU3317	—	—	—	—	98	98	106	110	—	167	—	—	2.5	2.5	9.23	
	210	52	4	4	113	177	—	416	350	49.7	3 000	4 000	NU417	NJ417	NUP417	N417	NF417	101	101	111	115	128	194	194	179	3	3	8.68
	90	140	24	1.5	1.1	103	—	106	109	14.6	4 700	5 600	NU1018	—	NUP1018	—	—	98	96.5	101	106	—	132	—	—	1.5	1	1.34

[Remarks] 1) Standard cage types used for the above bearings are shown in Table 1 earlier in this section. Please note that basic load ratings and limiting speeds shown above indicate the value applicable to machined cage. Consult JTEKT about bearings with pressed cage, since they may be different from bearings with machined cage in values above.

2) Bearing numbers of NU and NJ type bearings with mounted thrust collar (refer to specification table shown after this specification table) are NUJ and NH.

Single-row cylindrical roller bearings

d (90) ~ (100) mm

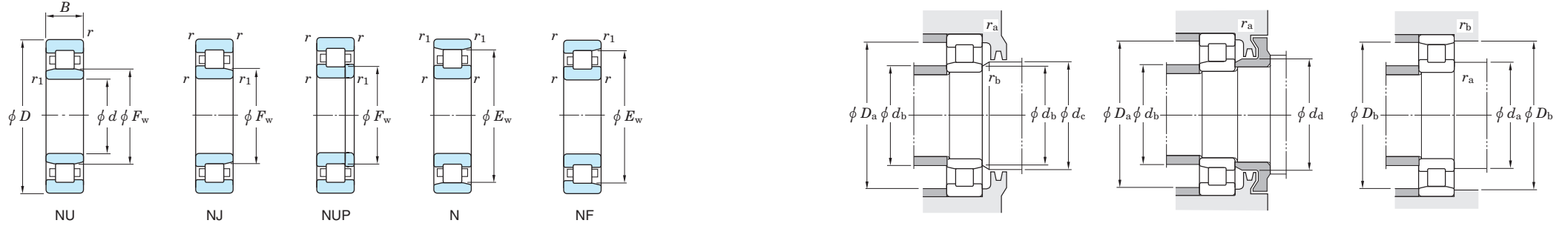

Boundary dimensions (mm)							Basic load ratings (kN)		Fatigue load limit (kN)	Limiting speeds (min ⁻¹)		Bearing No.					Mounting dimensions (mm)								(Refer.) Mass				
d	D	B	$r_{min.}$	$r_{1min.}$	F_w	E_w	C_r	C_{0r}	C_u	Grease lub.	Oil lub.	NU	NJ	NUP	N	NF	d_a min.	d_b min.	d_b max.	d_c min.	d_d min.	D_a max.	D_b max.	r_a min.	r_a max.	r_b min.	r_b max.	NU (kg)	
90	160	30	2	2	—	143	190	178	22.9	3 900	4 700	—	—	—	N218	NF218	99	—	—	—	116	151	151	146	2	2	2	2	(2.32)
	160	30	2	2	107	—	227	217	28.7	3 900	4 700	NU218R	NJ218R	NUP218R	—	—	99	99	105	109	116	151	—	—	2	2	2	2	2.38
	160	40	2	2	107	—	259	265	38.9	3 500	4 700	NU2218	NJ2218	NUP2218	—	—	99	99	105	109	116	151	—	—	2	2	2	2	3.10
	160	40	2	2	107	—	302	314	45.8	3 500	4 700	NU2218R	NJ2218R	NUP2218R	—	—	99	99	105	109	116	151	—	—	2	2	2	2	3.21
	160	52.4	2	2	107	—	338	373	52.8	3 100	4 700	NU3218	—	—	—	—	99	99	105	109	—	151	—	—	2	2	2	2	4.49
	190	43	3	3	—	165	300	265	38.7	3 100	4 200	—	—	—	N318	NF318	103	—	—	—	127	177	177	169	2.5	2.5	2.5	2.5	(5.27)
	190	43	3	3	113.5	—	395	355	50.6	3 100	4 100	NU318R	NJ318R	NUP318R	—	—	103	103	111	117	127	177	—	—	2.5	2.5	2.5	2.5	5.47
	190	64	3	3	115	—	408	395	55.5	2 800	4 200	NU2318	NJ2318	NUP2318	—	—	103	103	111	117	127	177	—	—	2.5	2.5	2.5	2.5	7.90
	190	64	3	3	113.5	—	544	534	74.5	2 800	4 100	NU2318R	NJ2318R	NUP2318R	—	—	103	103	111	117	127	177	—	—	2.5	2.5	2.5	2.5	8.12
	190	73	3	3	115	—	535	559	75.6	2 800	4 200	NU3318	—	—	—	—	103	103	111	117	—	177	—	—	2.5	2.5	2.5	2.5	10.3
	225	54	4	4	123.5	191.5	468	400	55.1	2 800	3 700	NU418	NJ418	NUP418	N418	NF418	106	106	122	125	139	209	209	194	3	3	3	3	10.3
95	145	24	1.5	1.1	108	—	110	115	15.2	4 500	5 300	NU1019	—	NUP1019	—	—	103	101.5	106	111	—	137	—	—	1.5	1	1	1	1.40
	170	32	2.1	2.1	—	151.5	207	195	25.1	3 700	4 400	—	—	—	N219	NF219	106	—	—	—	123	159	159	155	2	2	2	2	(2.80)
	170	32	2.1	2.1	112.5	—	275	265	38.3	3 700	4 400	NU219R	NJ219R	NUP219R	—	—	106	106	111	116	123	159	—	—	2	2	2	2	2.92
	170	43	2.1	2.1	113.5	—	288	298	42.9	3 300	4 400	NU2219	NJ2219	NUP2219	—	—	106	106	111	116	123	159	—	—	2	2	2	2	3.85
	170	43	2.1	2.1	112.5	—	358	371	52.8	3 300	4 400	NU2219R	NJ2219R	NUP2219R	—	—	106	106	111	116	123	159	—	—	2	2	2	2	3.93
	170	55.6	2.1	2.1	113.5	—	371	412	57.2	3 000	4 400	NU3219	—	—	—	—	106	106	111	116	—	159	—	—	2	2	2	2	5.42
	200	45	3	3	—	173.5	323	311	41.3	3 000	4 000	—	—	—	N319	NF319	108	—	—	—	134	187	187	178	2.5	2.5	2.5	2.5	(6.10)
	200	45	3	3	121.5	—	418	387	54.3	2 900	3 900	NU319R	NJ319R	NUP319R	—	—	108	108	119	124	134	187	—	—	2.5	2.5	2.5	2.5	6.42
	200	67	3	3	121.5	—	465	496	62.6	2 600	4 000	NU2319	NJ2319	NUP2319	—	—	108	108	119	124	134	187	—	—	2.5	2.5	2.5	2.5	9.39
	200	77.8	3	3	121.5	—	609	654	86.8	2 600	4 000	NU3319	—	—	—	—	108	108	119	124	—	187	—	—	2.5	2.5	2.5	2.5	12.1
	240	55	4	4	133.5	201.5	502	444	60.1	2 600	3 400	NU419	NJ419	NUP419	N419	NF419	111	111	132	136	149	224	224	204	3	3	3	3	13.6
100	150	24	1.5	1.1	113	—	114	120	15.8	4 300	5 100	NU1020	—	NUP1020	—	—	108	106.5	111	116	—	142	—	—	1.5	1	1	1	1.46
	180	34	2.1	2.1	—	160	229	217	28.1	3 500	4 200	—	—	—	N220	NF220	111	—	—	—	130	169	169	164	2	2	2	2	(3.38)
	180	34	2.1	2.1	119	—	312	306	43.0	3 500	4 200	NU220R	NJ220R	NUP220R	—	—	111	111	117	122	130	169	—	—	2	2	2	2	3.52
	180	46	2.1	2.1	120	—	322	338	47.3	3 100	4 200	NU2220	NJ2220	NUP2220	—	—	111	111	117	122	130	169	—	—	2	2	2	2	4.67
	180	46	2.1	2.1	119	—	417	444	60.7	3 100	4 200	NU2220R	NJ2220R	NUP2220R	—	—	111	111	117	122	130	169	—	—	2	2	2	2	4.82

[Remarks] 1) Standard cage types used for the above bearings are shown in Table 1 earlier in this section. Please note that basic load ratings and limiting speeds shown above indicate the value applicable to machined cage. Consult JTEKT about bearings with pressed cage, since they may be different from bearings with machined cage in values above.

2) Bearing numbers of NU and NJ type bearings with mounted thrust collar (refer to specification table shown after this specification table) are NUJ and NH.

Single-row cylindrical roller bearings

d (100) ~ (120) mm

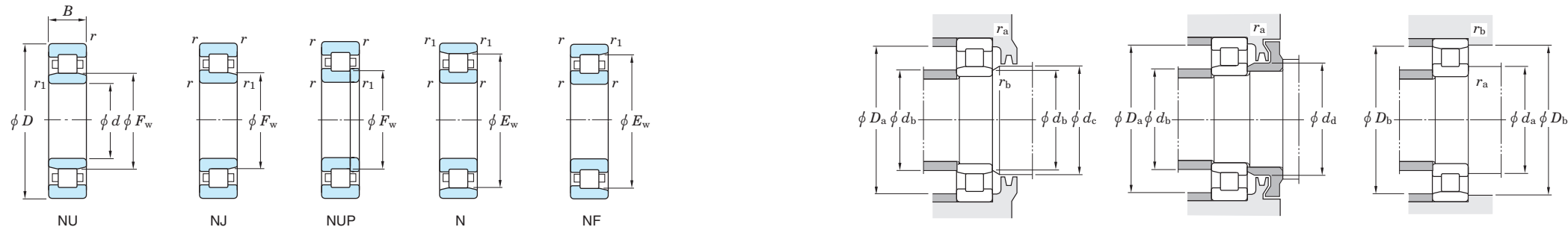

Boundary dimensions (mm)							Basic load ratings (kN)		Fatigue load limit (kN) C_u	Limiting speeds (min ⁻¹)		Bearing No.					Mounting dimensions (mm)										(Refer.) Mass NU (N) (kg)
d	D	B	$r_{min.}$	$r_{1min.}$	F_w	E_w	C_r	C_{0r}		Grease lub.	Oil lub.	NU	NJ	NUP	N	NF	d_a min.	d_b min.	d_b max.	d_c min.	d_d min.	D_a max.	D_b max.	r_a min.	r_b max.	r_a max.	
100	180	60.3	2.1	2.1	120	—	409	459	61.9	2 800	4 200	NU3220	—	—	—	111	111	117	122	—	169	—	—	2	2	6.62	
	215	47	3	3	—	185.5	373	337	47.2	2 800	3 700	—	—	—	N320	NF320	113	—	—	—	143	202	202	190	2.5	2.5	(7.59)
	215	47	3	3	127.5	—	474	424	58.7	2 700	3 600	NU320R	NJ320R	NUP320R	—	—	113	113	125	132	143	202	—	—	2.5	2.5	7.75
	215	73	3	3	129.5	—	513	548	68.4	2 500	3 700	NU2320	NJ2320	NUP2320	—	—	113	113	125	132	143	202	—	—	2.5	2.5	11.9
	215	73	3	3	127.5	—	713	717	94.7	2 400	3 600	NU2320R	NJ2320R	NUP2320R	—	—	113	113	125	132	143	202	—	—	2.5	2.5	12.1
	215	82.6	3	3	129.5	—	663	706	93.2	2 500	3 700	NU3320	—	—	—	—	113	113	125	132	—	202	—	—	2.5	2.5	15.0
	250	58	4	4	139	211	—	560	498	67.3	2 500	3 300	NU420	NJ420	NUP420	N420	NF420	116	116	137	141	156	234	234	213	3	3
105	160	26	2	1.1	119.5	—	136	149	19.6	4 100	4 800	NU1021	—	NUP1021	—	—	114	111.5	118	122	—	151	—	—	2	1	1.85
	190	36	2.1	2.1	—	168.8	251	241	34.1	3 300	3 900	—	—	—	N221	NF221	116	—	—	—	137	179	179	173	2	2	(4.44)
	190	65.1	2.1	2.1	126.8	—	431	482	64.3	2 600	3 900	NU3221	—	—	—	—	116	116	124	129	—	179	—	—	2	2	8.00
	225	49	3	3	—	195	426	417	53.1	2 600	3 500	—	—	—	N321	NF321	118	—	—	—	149	212	212	199	2.5	2.5	(8.68)
	225	77	3	3	135	—	711	750	97.3	2 300	3 500	NU2321	—	NUP2321	—	—	118	118	131	138	—	212	—	—	2.5	2.5	15.6
	225	87.3	3	3	135	—	799	871	113	2 300	3 500	NU3321	—	—	—	—	118	118	132	137	—	212	—	—	2.5	2.5	17.4
	260	60	4	4	144.5	220.5	—	581	510	67.6	2 400	3 100	NU421	NJ421	NUP421	N421	NF421	121	121	143	147	162	244	244	223	3	3
110	170	28	2	1.1	125	—	168	171	21.7	3 800	4 500	NU1022	—	NUP1022	—	—	119	116.5	124	128	—	161	—	—	2	1	2.31
	200	38	2.1	2.1	—	178.5	300	290	40.1	3 100	3 700	—	—	—	N222	NF222	121	—	—	—	144	189	189	182	2	2	(5.24)
	200	38	2.1	2.1	132.5	—	366	365	51.1	3 100	3 700	NU222R	NJ222R	NUP222R	—	—	121	121	130	135	144	189	—	—	2	2	4.90
	200	53	2.1	2.1	132.5	—	397	442	55.1	2 800	3 700	NU2222	NJ2222	NUP2222	—	—	121	121	130	135	144	189	—	—	2	2	6.93
	200	53	2.1	2.1	132.5	—	479	517	69.9	2 800	3 700	NU2222R	NJ2222R	NUP2222R	—	—	121	121	130	135	144	189	—	—	2	2	6.93
	200	69.8	2.1	2.1	132.5	—	533	607	80.6	2 500	3 700	NU3222	—	—	—	—	121	121	130	135	—	189	—	—	2	2	9.55
	240	50	3	3	—	207	475	467	58.4	2 500	3 300	—	—	—	N322	NF322	123	—	—	—	158	227	227	211	2.5	2.5	(10.4)
	240	50	3	3	143	—	564	525	70.0	2 400	3 200	NU322R	NJ322R	NUP322R	—	—	123	123	140	145	158	227	—	—	2.5	2.5	10.7
	240	80	3	3	143	—	755	789	102	2 200	3 300	NU2322	NJ2322	NUP2322	—	—	123	123	140	145	158	227	—	—	2.5	2.5	18.8
	240	80	3	3	143	—	843	880	112	2 200	3 200	NU2322R	NJ2322R	NUP2322R	—	—	123	123	140	145	158	227	—	—	2.5	2.5	18.8
	240	92.1	3	3	143	—	849	918	118	2 200	3 300	NU3322	—	—	—	—	123	123	140	145	—	227	—	—	2.5	2.5	21.1
280	65	4	4	155	235	—	685	621	80.8	2 200	2 900	NU422	NJ422	NUP422	N422	NF422	126	126	153	157	173	264	264	237	3	3	19.9
120	180	28	2	1.1	135	—	173	181	22.6	3 500	4 200	NU1024	—	NUP1024	—	—	129	126.5	134	138	—	171	—	—	2	1	2.47

[Remarks] 1) Standard cage types used for the above bearings are shown in Table 1 earlier in this section. Please note that basic load ratings and limiting speeds shown above indicate the value applicable to machined cage. Consult JTEKT about bearings with pressed cage, since they may be different from bearings with machined cage in values above.

2) Bearing numbers of NU and NJ type bearings with mounted thrust collar (refer to specification table shown after this specification table) are NUJ and NH.

Single-row cylindrical roller bearings

d (120) ~ (140) mm

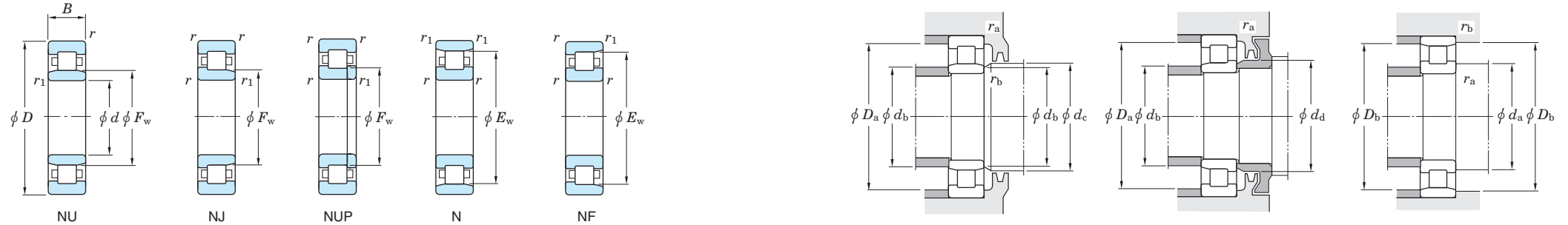

Boundary dimensions (mm)							Basic load ratings (kN)		Fatigue load limit (kN)	Limiting speeds (min ⁻¹)		Bearing No.					Mounting dimensions (mm)								(Refer.) Mass (kg)				
d	D	B	r min.	r1 min.	Fw	Ew	Cr	C0r	Cu	Grease lub.	Oil lub.	NU	NJ	NUP	N	NF	da min.	db min.	db max.	dc min.	da min.	Da max.	Db max.	ra min.	rb max.	ra min.	rb max.	(N)	
120	215	40	2.1	2.1	—	191.5	325	318	42.9	2 900	3 400	—	—	—	N224	NF224	131	—	—	—	156	204	204	196	2	2	—	—	(6.31)
	215	40	2.1	2.1	143.5	—	419	421	57.6	2 800	3 400	NU224R	NJ224R	NUP224R	—	—	131	131	141	146	156	204	—	—	2	2	—	—	5.85
	215	58	2.1	2.1	143.5	—	434	492	61.2	2 600	3 400	NU2224	NJ2224	NUP2224	—	—	131	131	141	146	156	204	—	—	2	2	—	—	8.56
	215	58	2.1	2.1	143.5	—	565	619	80.9	2 600	3 400	NU2224R	NJ2224R	NUP2224R	—	—	131	131	141	146	156	204	—	—	2	2	—	—	8.56
	215	76	2.1	2.1	143.5	—	596	695	89.2	2 300	3 400	NU3224	—	—	—	—	131	131	141	146	—	204	—	—	2	2	—	—	11.9
	260	55	3	3	—	226	561	551	67.1	2 200	3 000	—	—	—	N324	NF324	133	—	—	—	171	247	247	230	2.5	2.5	—	—	(13.1)
	260	55	3	3	154	—	660	610	79.8	2 200	3 000	NU324R	NJ324R	NUP324R	—	—	133	133	151	156	171	247	—	—	2.5	2.5	—	—	13.4
	260	86	3	3	154	—	886	918	116	2 000	3 000	NU2324	NJ2324	NUP2324	—	—	133	133	151	156	171	247	—	—	2.5	2.5	—	—	23.1
	260	86	3	3	154	—	991	1 030	129	2 000	3 000	NU2324R	NJ2324R	NUP2324R	—	—	133	133	151	156	172	247	—	—	2.5	2.5	—	—	23.1
	260	106	3	3	154	—	1 030	1 120	139	2 000	3 000	NU3324	—	—	—	—	133	133	151	156	—	247	—	—	2.5	2.5	—	—	28.3
310	72	5	5	170	260	841	770	98.7	1 900	2 600	NU424	NJ424	NUP424	N424	NF424	140	140	168	172	190	290	290	262	4	4	—	—	28.0	
130	200	33	2	1.1	148	—	215	238	29.5	3 200	3 800	NU1026	—	NUP1026	—	—	139	136.5	146	151	—	191	—	—	2	1	—	—	3.77
	230	40	3	3	—	204	338	362	45.2	2 700	3 200	—	—	—	N226	NF226	143	—	—	—	168	217	217	208	2.5	2.5	—	—	(7.21)
	230	40	3	3	153.5	—	454	453	61.0	2 600	3 200	NU226R	NJ226R	NUP226R	—	—	143	143	151	158	168	217	—	—	2.5	2.5	—	—	6.60
	230	64	3	3	156	—	474	560	68.7	2 400	3 200	NU2226	NJ2226	NUP2226	—	—	143	143	151	158	168	217	—	—	2.5	2.5	—	—	11.2
	230	64	3	3	153.5	—	662	737	95.8	2 400	3 200	NU2226R	NJ2226R	NUP2226R	—	—	143	143	151	158	168	217	—	—	2.5	2.5	—	—	11.2
	230	80	3	3	156	—	689	857	107	2 100	3 200	NU3226	—	—	—	—	143	143	151	158	—	217	—	—	2.5	2.5	—	—	14.1
	280	58	4	4	—	243	699	667	85.7	2 100	2 700	—	—	—	N326	NF326	146	—	—	—	184	264	264	247	3	3	—	—	(16.4)
	280	58	4	4	167	—	771	736	94.1	2 000	2 700	NU326R	NJ326R	NUP326R	—	—	146	146	164	169	184	264	—	—	3	3	—	—	16.7
	280	93	4	4	167	—	1 050	1 130	138	1 800	2 700	NU2326	NJ2326	NUP2326	—	—	146	146	164	169	184	264	—	—	3	3	—	—	29.1
	280	93	4	4	167	—	1 150	1 230	150	1 800	2 700	NU2326R	NJ2326R	NUP2326R	—	—	146	146	164	169	186	264	—	—	3	3	—	—	29.1
280	112	4	4	167	—	1 170	1 290	158	1 800	2 700	NU3326	—	—	—	—	146	146	164	169	—	264	—	—	3	3	—	—	34.6	
340	78	5	5	185	285	964	876	108	1 800	2 300	NU426	NJ426	NUP426	N426	NF426	150	150	183	187	208	320	320	287	4	4	—	—	36.1	
140	210	33	2	1.1	158	—	220	250	30.5	3 000	3 600	NU1028	—	NUP1028	—	—	149	146.5	156	161	—	201	—	—	2	1	—	—	4.00
	250	42	3	3	—	221	406	421	55.5	2 400	2 900	—	—	—	N228	NF228	153	—	—	—	182	237	237	228	2.5	2.5	—	—	(8.78)
	250	42	3	3	169	—	491	514	67.5	2 400	2 900	NU228R	NJ228R	NUP228R	—	—	153	153	166	171	182	237	—	—	2.5	2.5	—	—	8.50
	250	68	3	3	169	—	583	671	84.3	2 200	2 900	NU2228	NJ2228	NUP2228	—	—	153	153	166	171	182	237	—	—	2.5	2.5	—	—	14.3
	250	68	3	3	169	—	716	835	106	2 200	2 900	NU2228R	NJ2228R	NUP2228R	—	—	153	153	166	171	182	237	—	—	2.5	2.5	—	—	14.3

[Remarks] 1) Standard cage types used for the above bearings are shown in Table 1 earlier in this section. Please note that basic load ratings and limiting speeds shown above indicate the value applicable to machined cage. Consult JTEKT about bearings with pressed cage, since they may be different from bearings with machined cage in values above.

2) Bearing numbers of NU and NJ type bearings with mounted thrust collar (refer to specification table shown after this specification table) are NUJ and NH.

Single-row cylindrical roller bearings

d (140) ~ (160) mm

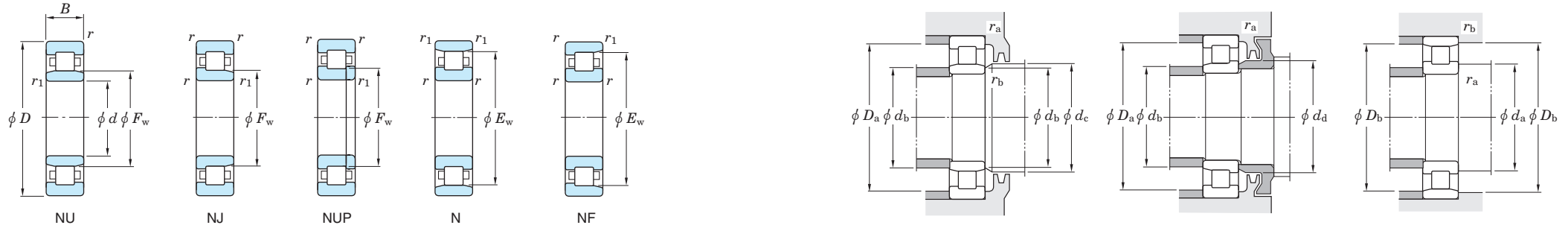

Boundary dimensions (mm)								Basic load ratings (kN)		Fatigue load limit (kN) C_u	Limiting speeds (min ⁻¹)		Bearing No.					Mounting dimensions (mm)							(Refer.) Mass NU (N) (kg)		
<i>d</i>	<i>D</i>	<i>B</i>	<i>r</i> min.	<i>r</i> ₁ min.	<i>F</i> _w	<i>E</i> _w	<i>C</i> _r	<i>C</i> _{0r}	Grease lub.		Oil lub.	NU	NJ	NUP	N	NF	<i>d</i> _a min.	<i>d</i> _b min.	<i>d</i> _b max.	<i>d</i> _c min.	<i>d</i> _d min.	<i>D</i> _a max.	<i>D</i> _b max.	<i>r</i> _a min.		<i>r</i> _b max.	
140	250	88	3	3	169	—	757	939	114	1 900	2 900	NU3228	—	—	—	153	153	166	171	—	237	—	—	2.5	2.5	18.5	
	300	62	4	4	—	260	771	746	93.8	1 900	2 500	—	—	—	N328	NF328	156	—	—	—	198	284	284	264	3	3	(21.8)
	300	62	4	4	180	—	829	797	99.4	1 900	2 500	NU328R	NJ328R	NUP328R	—	—	156	156	176	182	198	284	—	—	3	3	21.8
	300	102	4	4	180	—	1 150	1 250	150	1 700	2 500	NU2328	NJ2328	NUP2328	—	—	156	156	176	182	198	284	—	—	3	3	36.8
	300	102	4	4	180	—	1 270	1 380	167	1 700	2 500	NU2328R	NJ2328R	NUP2328R	—	—	156	156	176	182	200	284	—	—	3	3	36.8
	300	118	4	4	180	—	1 360	1 550	185	1 700	2 500	NU3328	—	—	—	—	156	156	176	182	—	284	—	—	3	3	41.5
	360	82	5	5	198	302	1 090	1 020	124	1 600	2 200	NU428	NJ428	NUP428	N428	NF428	160	160	195	200	222	340	340	304	4	4	46.8
150	225	35	2.1	1.5	169.5	—	252	281	32.8	2 800	3 300	NU1030	—	NUP1030	—	—	161	158	167	173	—	214	—	—	2	1.5	4.83
	270	45	3	3	—	238	468	492	63.4	2 200	2 700	—	—	—	N230	NF230	163	—	—	—	196	257	257	245	2.5	2.5	(11.1)
	270	45	3	3	182	—	560	594	75.8	2 200	2 600	NU230R	NJ230R	NUP230R	—	—	163	163	179	184	196	257	—	—	2.5	2.5	10.7
	270	73	3	3	182	—	683	800	99.7	2 000	2 700	NU2230	NJ2230	NUP2230	—	—	163	163	179	184	196	257	—	—	2.5	2.5	18.7
	270	73	3	3	182	—	828	982	120	2 000	2 600	NU2230R	NJ2230R	NUP2230R	—	—	163	163	179	184	196	257	—	—	2.5	2.5	18.7
	270	96	3	3	182	—	939	1 200	143	1 800	2 700	NU3230	—	—	—	—	163	163	179	184	—	257	—	—	2.5	2.5	23.7
	320	65	4	4	—	277	829	807	99.1	1 800	2 300	—	—	—	N330	NF330	166	—	—	—	213	304	304	281	3	3	(25.6)
	320	65	4	4	193	—	948	922	115	1 700	2 300	NU330R	NJ330R	NUP330R	—	—	166	166	190	195	213	304	—	—	3	3	27.0
	320	108	4	4	193	—	1 270	1 400	167	1 600	2 300	NU2330	NJ2330	NUP2330	—	—	166	166	190	195	213	304	—	—	3	3	44.7
	320	108	4	4	193	—	1 450	1 600	187	1 500	2 300	NU2330R	NJ2330R	NUP2330R	—	—	166	166	190	195	213	304	—	—	3	3	44.7
	320	128	4	4	193	—	1 610	1 890	217	1 600	2 300	NU3330	—	—	—	—	166	166	190	195	—	304	—	—	3	3	51.4
	380	85	5	5	213	317	1 160	1 120	134	1 500	2 000	NU430	NJ430	NUP430	N430	NF430	170	170	210	216	237	360	360	319	4	4	53.3
160	240	38	2.1	1.5	180	—	297	330	42.8	2 600	3 000	NU1032	—	NUP1032	—	—	171	168	178	184	—	229	—	—	2	1.5	5.93
	290	48	3	3	—	255	535	568	71.3	2 100	2 500	—	—	—	N232	NF232	173	—	—	—	210	277	277	262	2.5	2.5	(13.9)
	290	48	3	3	195	—	624	666	83.3	2 000	2 400	NU232R	NJ232R	NUP232R	—	—	173	173	192	197	210	277	—	—	2.5	2.5	14.8
	290	80	3	3	195	—	790	939	113	1 800	2 500	NU2232	NJ2232	NUP2232	—	—	173	173	192	197	210	277	—	—	2.5	2.5	23.6
	290	80	3	3	193	—	1 010	1 190	141	1 800	2 400	NU2232R	NJ2232R	NUP2232R	—	—	173	173	192	197	210	277	—	—	2.5	2.5	23.6
	290	104	3	3	195	—	1 070	1 390	163	1 600	2 500	NU3232	—	—	—	—	173	173	192	197	—	277	—	—	2.5	2.5	29.8
	340	68	4	4	—	292	872	876	106	1 600	2 200	—	—	—	N332	NF332	176	—	—	—	228	324	324	296	3	3	(30.2)
	340	68	4	4	204	—	1 070	1 050	128	1 600	2 100	NU332R	NJ332R	NUP332R	—	—	176	176	200	211	228	324	—	—	3	3	32.0

[Remarks] 1) Standard cage types used for the above bearings are shown in Table 1 earlier in this section. Please note that basic load ratings and limiting speeds shown above indicate the value applicable to machined cage. Consult JTEKT about bearings with pressed cage, since they may be different from bearings with machined cage in values above.

2) Bearing numbers of NU and NJ type bearings with mounted thrust collar (refer to specification table shown after this specification table) are NUJ and NH.

Single-row cylindrical roller bearings

d (160) ~ (190) mm

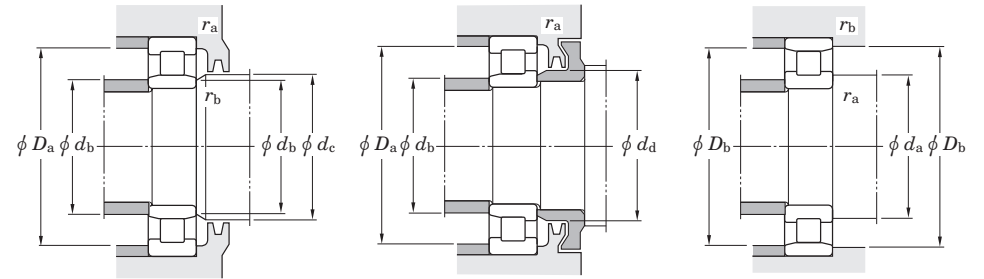
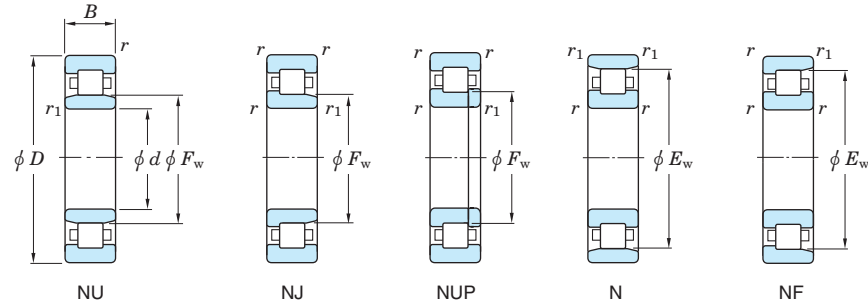

Boundary dimensions (mm)								Basic load ratings (kN)		Fatigue load limit (kN) <i>C_u</i>	Limiting speeds (min ⁻¹)		Bearing No.					Mounting dimensions (mm)							(Refer.) Mass NU (N) (kg)			
<i>d</i>	<i>D</i>	<i>B</i>	<i>r</i> min.	<i>r</i> ₁ min.	<i>F_w</i>	<i>E_w</i>	<i>C_r</i>	<i>C_{0r}</i>	<i>C_u</i>	Grease lub.	Oil lub.	NU	NJ	NUP	N	NF	<i>d_a</i> min.	<i>d_b</i> min.	<i>d_b</i> max.	<i>d_c</i> min.	<i>d_d</i> min.	<i>D_a</i> max.	<i>D_b</i> max.	<i>r_a</i> min.	<i>r_b</i> max.	<i>r_a</i> max.	<i>r_b</i> max.	
160	340	114	4	4	208	—	1 340	1 520	178	1 400	2 200	NU2332	NJ2332	NUP2332	—	—	176	176	200	211	228	324	—	—	3	3	—	53.1
	340	114	4	4	204	—	1 640	1 820	212	1 400	2 100	NU2332R	NJ2332R	NUP2332R	—	—	176	176	200	211	228	324	—	—	3	3	—	53.1
	340	136	4	4	208	—	1 590	1 890	216	1 400	2 200	NU3332	—	—	—	—	176	176	200	211	—	324	—	—	3	3	—	61.5
170	260	42	2.1	2.1	193	—	347	400	50.5	2 400	2 800	NU1034	—	NUP1034	—	—	181	181	190	197	—	249	—	—	2	2	—	7.90
	310	52	4	4	—	272	596	637	78.4	1 900	2 300	—	—	—	N234	NF234	186	—	—	—	223	294	294	280	3	3	—	(17.2)
	310	52	4	4	207	—	754	802	98.7	1 900	2 200	NU234R	NJ234R	NUP234R	—	—	186	186	204	211	223	294	—	—	3	3	—	18.6
	310	86	4	4	208	—	896	1 080	127	1 700	2 300	NU2234	NJ2234	NUP2234	—	—	186	186	204	211	223	294	—	—	3	3	—	29.2
	310	86	4	4	205	—	1 210	1 410	166	1 700	2 200	NU2234R	NJ2234R	NUP2234R	—	—	186	186	204	211	223	294	—	—	3	3	—	29.2
	310	110	4	4	208	—	1 210	1 580	181	1 500	2 300	NU3234	—	—	—	—	186	186	204	211	—	294	—	—	3	3	—	36.2
	360	72	4	4	220	310	997	1 010	122	1 500	2 000	NU334	NJ334	NUP334	N334	NF334	186	186	216	223	241	344	344	314	3	3	—	38.6
	360	120	4	4	220	—	1 530	1 750	199	1 300	2 000	NU2334	NJ2334	NUP2334	—	—	186	186	216	223	241	344	—	—	3	3	—	62.6
360	140	4	4	220	—	1 770	2 120	240	1 300	2 000	NU3334	—	—	—	—	186	186	216	223	—	344	—	—	3	3	—	70.8	
180	280	46	2.1	2.1	205	—	447	503	63.2	2 200	2 600	NU1036	—	NUP1036	—	—	191	191	203	209	—	269	—	—	2	2	—	10.5
	320	52	4	4	—	282	618	677	82.2	1 800	2 200	—	—	—	N236	NF236	196	—	—	—	233	304	304	290	3	3	—	(18.0)
	320	52	4	4	217	—	783	852	104	1 800	2 100	NU236R	NJ236R	NUP236R	—	—	196	196	214	221	233	304	—	—	3	3	—	19.3
	320	86	4	4	218	—	929	1 140	133	1 600	2 200	NU2236	NJ2236	NUP2236	—	—	196	196	214	221	233	304	—	—	3	3	—	30.4
	320	86	4	4	215	—	1 260	1 510	175	1 600	2 100	NU2236R	NJ2236R	NUP2236R	—	—	196	196	214	221	233	304	—	—	3	3	—	30.4
	320	112	4	4	218	—	1 250	1 680	190	1 400	2 200	NU3236	—	—	—	—	196	196	214	221	—	304	—	—	3	3	—	38.4
	380	75	4	4	232	328	1 130	1 150	136	1 400	1 900	NU336	NJ336	NUP336	N336	NF336	196	196	227	235	255	364	364	332	3	3	—	42.6
	380	126	4	4	232	—	1 690	1 940	220	1 300	1 900	NU2336	NJ2336	NUP2336	—	—	196	196	227	235	255	364	—	—	3	3	—	73.0
	380	150	4	4	232	—	2 070	2 520	276	1 300	1 900	NU3336	—	—	—	—	196	196	227	235	—	364	—	—	3	3	—	84.4
190	290	46	2.1	2.1	215	—	460	530	65.7	2 100	2 500	NU1038	—	NUP1038	—	—	201	201	213	219	—	279	—	—	2	2	—	10.9
	340	55	4	4	—	299	694	768	91.3	1 700	2 000	—	—	—	N238	NF238	206	—	—	—	247	324	324	310	3	3	—	(21.5)
	340	55	4	4	230	—	869	954	114	1 700	2 000	NU238R	NJ238R	NUP238R	—	—	206	206	227	234	247	324	—	—	3	3	—	23.3
	340	92	4	4	231	—	1 040	1 290	146	1 500	2 000	NU2238	NJ2238	NUP2238	—	—	206	206	227	234	247	324	—	—	3	3	—	37.0
	340	92	4	4	228	—	1 380	1 670	189	1 500	2 000	NU2238R	NJ2238R	NUP2238R	—	—	206	206	227	234	247	324	—	—	3	3	—	37.0
	340	120	4	4	231	—	1 420	1 930	226	1 300	2 000	NU3238	—	—	—	—	206	206	227	234	—	324	—	—	3	3	—	46.8

[Remarks] 1) Standard cage types used for the above bearings are shown in Table 1 earlier in this section. Please note that basic load ratings and limiting speeds shown above indicate the value applicable to machined cage. Consult JTEKT about bearings with pressed cage, since they may be different from bearings with machined cage in values above.

2) Bearing numbers of NU and NJ type bearings with mounted thrust collar (refer to specification table shown after this specification table) are NUJ and NH.

Single-row cylindrical roller bearings

d (190) ~ 240 mm

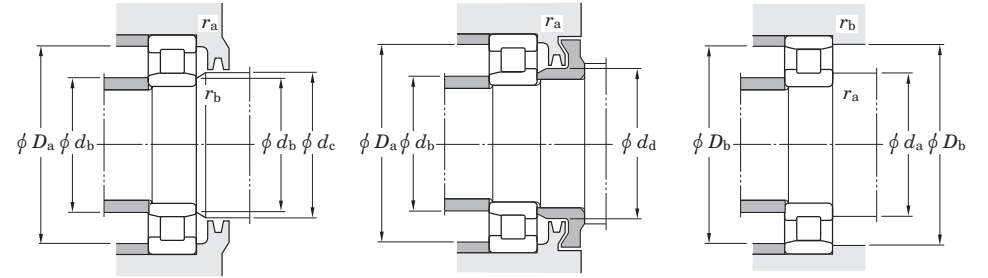
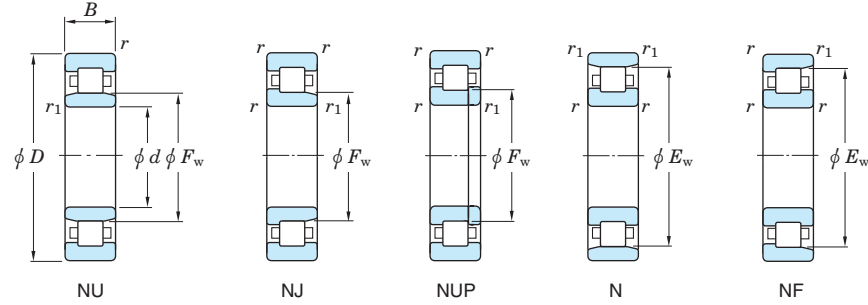

Boundary dimensions (mm)								Basic load ratings (kN)		Fatigue load limit (kN) C_u	Limiting speeds (min ⁻¹)		Bearing No.					Mounting dimensions (mm)								(Refer.) Mass NU (N) (kg)	
d	D	B	$r_{min.}$	$r_{1min.}$	F_w	E_w	C_r	C_{0r}		Grease lub.	Oil lub.	NU	NJ	NUP	N	NF	d_a min.	d_b min.	d_b max.	d_c min.	d_d min.	D_a max.	D_b max.	r_a min.	r_b max.		
190	400	78	5	5	245	345	1 220	1 260	146	1 300	1 800	NU338	NJ338	NUP338	N338	NF338	210	210	240	248	268	380	380	349	4	4	49.9
	400	132	5	5	245	—	1 900	2 220	245	1 200	1 800	NU2338	NJ2338	NUP2338	—	—	210	210	240	248	268	380	—	—	4	4	84.7
	400	155	5	5	245	—	2 340	2 910	316	1 200	1 800	NU3338	—	—	—	—	210	210	240	248	—	380	—	—	4	4	96.5
200	310	51	2.1	2.1	229	—	487	582	71.0	1 900	2 300	NU1040	—	NUP1040	—	—	211	211	226	233	—	299	—	—	2	2	14.1
	360	58	4	4	—	316	775	865	102	1 600	1 900	—	—	—	N240	NF240	216	—	—	—	261	344	344	328	3	3	(25.7)
	360	58	4	4	243	—	958	1 060	124	1 600	1 900	NU240R	NJ240R	NUP240R	—	—	216	216	240	247	261	344	—	—	3	3	27.2
	360	98	4	4	244	—	1 190	1 490	169	1 400	1 900	NU2240	NJ2240	NUP2240	—	—	216	216	240	247	261	344	—	—	3	3	44.4
	360	98	4	4	241	—	1 530	1 870	211	1 400	1 900	NU2240R	NJ2240R	NUP2240R	—	—	216	216	240	247	261	344	—	—	3	3	44.4
	360	128	4	4	244	—	1 500	2 020	223	1 300	1 900	NU3240	—	—	—	—	216	216	240	247	—	344	—	—	3	3	56.2
	420	80	5	5	260	360	1 220	1 270	145	1 200	1 700	NU340	NJ340	NUP340	N340	NF340	220	220	254	263	283	400	400	364	4	4	56.2
	420	138	5	5	260	—	1 890	2 240	244	1 100	1 700	NU2340	NJ2340	NUP2340	—	—	220	220	254	263	283	400	—	—	4	4	97.4
	420	165	5	5	260	—	2 330	2 930	314	1 100	1 700	NU3340	—	—	—	—	220	220	250	258	—	400	—	—	4	4	113
220	340	56	3	3	250	—	637	748	88.1	1 700	2 000	NU1044	—	NUP1044	—	—	233	233	248	254	—	327	—	—	2.5	2.5	18.5
	400	65	4	4	270	350	949	1 080	123	1 400	1 700	NU244	NJ244	NUP244	N244	NF244	236	236	266	273	289	384	384	362	3	3	38.5
	400	108	4	4	270	—	1 420	1 810	196	1 200	1 700	NU2244	NJ2244	—	—	—	236	236	266	273	289	384	—	—	3	3	60.9
	400	144	4	4	270	—	2 040	2 880	319	1 100	1 700	NU3244	—	—	—	—	236	236	266	273	—	384	—	—	3	3	78.8
	460	88	5	5	284	396	1 490	1 570	176	1 100	1 500	NU344	NJ344	NUP344	N344	NF344	240	240	279	287	309	440	440	400	4	4	74.4
	460	145	5	5	284	—	2 260	2 690	287	990	1 500	NU2344	—	NUP2344	—	—	240	240	276	287	—	440	—	—	4	4	119
	460	180	5	5	284	—	2 660	3 300	347	990	1 500	NU3344	—	—	—	—	240	240	279	287	—	440	—	—	4	4	148
	240	360	56	3	3	270	—	673	822	95.0	1 600	1 900	NU1048	—	NUP1048	—	—	253	253	268	275	—	347	—	—	2.5	2.5
440		72	4	4	295	385	1 170	1 340	150	1 200	1 500	NU248	NJ248	NUP248	N248	NF248	256	256	293	298	316	424	424	397	3	3	52.1
440		120	4	4	295	—	1 790	2 320	246	1 100	1 500	NU2248	NJ2248	—	—	—	256	256	293	298	316	424	—	—	3	3	82.5
440		160	4	4	295	—	2 450	3 460	358	990	1 500	NU3248	—	—	—	—	256	256	293	298	—	424	—	—	3	3	107
500		95	5	5	310	430	1 790	1 950	211	990	1 300	NU348	NJ348	NUP348	N348	NF348	260	260	305	313	337	480	480	434	4	4	94.6
500		155	5	5	310	—	2 710	3 320	346	880	1 300	NU2348	—	NUP2348	—	—	260	260	303	313	—	480	—	—	4	4	152
500		195	5	5	310	—	3 170	4 070	414	880	1 300	NU3348	—	—	—	—	260	260	305	313	—	480	—	—	4	4	189

[Remarks] 1) Standard cage types used for the above bearings are shown in Table 1 earlier in this section. Please note that basic load ratings and limiting speeds shown above indicate the value applicable to machined cage. Consult JTEKT about bearings with pressed cage, since they may be different from bearings with machined cage in values above.

2) Bearing numbers of NU and NJ type bearings with mounted thrust collar (refer to specification table shown after this specification table) are NUJ and NH.

Single-row cylindrical roller bearings

d 260 ~ 460 mm

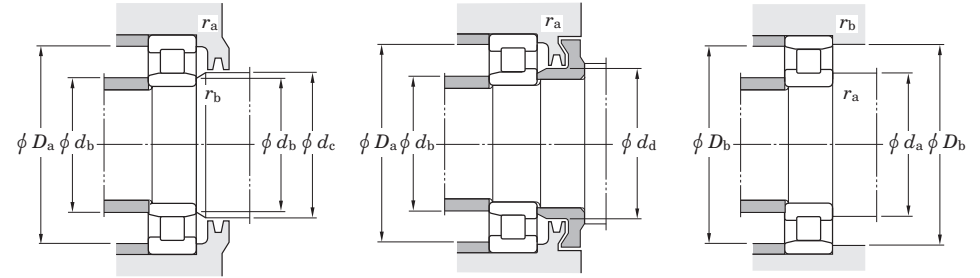
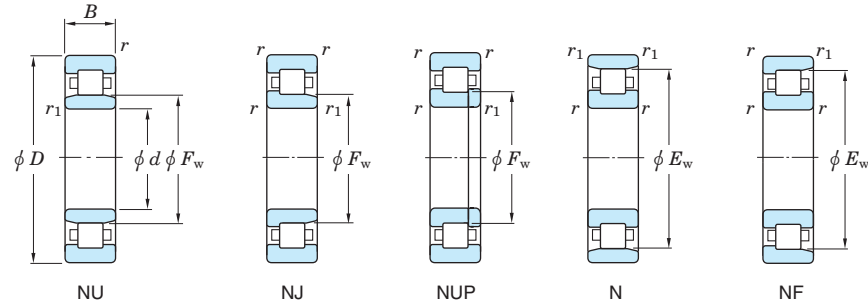

Boundary dimensions (mm)								Basic load ratings (kN)		Fatigue load limit (kN) C_u	Limiting speeds (min ⁻¹)		Bearing No.					Mounting dimensions (mm)								Mass (kg)	
d	D	B	r min.	r_1 min.	F_w	E_w	C_r	C_{0r}	Grease lub.		Oil lub.	NU	NJ	NUP	N	NF	d_a min.	d_b min.	d_b max.	d_c min.	d_d min.	D_a max.	D_b max.	r_a min.	r_b max.		Refer.) NU (N)
260	400	65	4	4	296	—	819	979	110	1 400	1 700	NU1052	—	NUP1052	—	—	276	276	292	300	—	384	—	—	3	3	29.2
	480	80	5	5	320	420	1 380	1 580	171	1 100	1 300	NU252	NJ252	NUP252	N252	NF252	280	280	318	323	343	460	460	432	4	4	69.0
	480	130	5	5	320	—	2 240	2 950	305	990	1 300	NU2252	NJ2252	—	—	—	280	280	318	323	343	460	—	—	4	4	107
	480	174	5	5	320	—	2 680	3 680	373	880	1 300	NU3252	—	—	—	—	280	280	318	323	—	460	—	—	4	4	139
	540	165	6	6	336	—	3 030	3 750	385	790	1 200	NU2352	—	NUP2352	—	—	284	284	327	339	—	516	—	—	5	5	185
	540	206	6	6	336	—	3 670	4 790	473	790	1 200	NU3352	—	—	—	—	284	284	330	339	—	516	—	—	5	5	232
280	420	65	4	4	316	—	841	1 030	114	1 300	1 500	NU1056	—	NUP1056	—	—	296	296	313	320	—	404	—	—	3	3	35.2
	500	80	5	5	340	440	1 430	1 680	179	1 000	1 200	NU256	NJ256	NUP256	N256	NF256	300	300	336	343	365	480	480	452	4	4	72.7
300	460	74	4	4	340	—	1 120	1 380	147	1 200	1 400	NU1060	—	NUP1060	—	—	316	316	337	344	—	444	—	—	3	3	44.1
	540	85	5	5	364	476	1 690	1 960	206	920	1 100	NU260	NJ260	NUP260	N260	NF260	320	320	361	368	392	520	520	487	4	4	90.7
320	480	74	4	4	360	—	1 150	1 450	152	1 100	1 300	NU1064	—	NUP1064	—	—	336	336	356	365	—	464	—	—	3	3	48.4
	580	92	5	5	390	510	1 920	2 270	232	840	1 000	NU264	NJ264	NUP264	N264	NF264	340	340	386	393	419	560	560	522	4	4	114
	670	112	7.5	7.5	425	—	2 460	2 880	287	650	870	NU364	—	—	—	—	352	352	419	428	—	638	638	575	6	6	199
340	520	82	5	5	385	—	1 370	1 750	183	980	1 200	NU1068	—	NUP1068	—	—	360	360	381	390	—	500	—	—	4	4	64.1
360	540	82	5	5	405	—	1 410	1 830	189	920	1 100	NU1072	—	NUP1072	—	—	380	380	401	410	—	520	—	—	4	4	67.1
380	560	82	5	5	425	—	1 440	1 920	195	860	1 000	NU1076	—	NUP1076	—	—	400	400	421	430	—	540	—	—	4	4	70.1
400	600	90	5	5	450	—	1 760	2 310	229	780	920	NU1080	—	NUP1080	—	—	420	420	446	455	—	580	—	—	4	4	91.0
420	620	90	5	5	470	—	1 750	2 320	228	730	860	NU1084	—	NUP1084	—	—	440	440	466	475	—	600	—	—	4	4	94.6
440	650	94	6	6	493	—	1 880	2 520	242	680	800	NU1088	—	NUP1088	—	—	464	464	489	498	—	626	—	—	5	5	109
460	680	100	6	6	516	—	2 000	2 730	259	630	750	NU1092	—	NUP1092	—	—	484	484	512	520	—	656	—	—	5	5	127

[Remarks] 1) Standard cage types used for the above bearings are shown in Table 1 earlier in this section. Please note that basic load ratings and limiting speeds shown above indicate the value applicable to machined cage. Consult JTEKT about bearings with pressed cage, since they may be different from bearings with machined cage in values above.

2) Bearing numbers of NU and NJ type bearings with mounted thrust collar (refer to specification table shown after this specification table) are NUJ and NH.

Thrust collars for cylindrical roller bearings

d 20 ~ (35) mm

d (35) ~ (50) mm

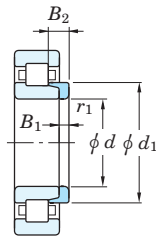

Thrust collar

Boundary dimensions (mm)					Thrust collar No.	(Refer.) Mass (kg)	Applicable bearing No.		
d	d_1	B_1	B_2	r_1 min.			NJ	NU	
20	29.7	3	6.75	0.6	HJ204	0.012	NJ204	NU204	
	29.8	3	5.5	0.6	HJ204R	0.011	NJ204R	NU204R	
	30	3	7.5	0.6	HJ2204	0.012	NJ2204	NU2204	
	29.8	3	6.5	0.6	HJ2204R	0.012	NJ2204R	NU2204R	
	31.8	4	7.5	0.6	HJ304	0.017	NJ304	NU304	
	31.4	4	6.5	0.6	HJ304R	0.017	NJ304R	NU304R	
	31.8	4	8.5	0.6	HJ2304	0.020	NJ2304	NU2304	
	31.4	4	7.5	0.6	HJ2304R	0.018	NJ2304R	NU2304R	
	25	34.7	3	7.25	0.6	HJ205	0.015	NJ205	NU205
34.8		3	6	0.6	HJ205R	0.014	NJ205R	NU205R	
34.7		3	7.5	0.6	HJ2205	0.015	NJ2205	NU2205	
34.8		3	6.5	0.6	HJ2205R	0.014	NJ2205R	NU2205R	
39		4	8	1.1	HJ305	0.025	NJ305	NU305	
38.2		4	7	1.1	HJ305R	0.025	NJ305R	NU305R	
39		4	9	1.1	HJ2305	0.025	NJ2305	NU2305	
38.2		4	8	1.1	HJ2305R	0.026	NJ2305R	NU2305R	
30		41.8	4	8.25	0.6	HJ206	0.025	NJ206	NU206
	41.4	4	7	0.6	HJ206R	0.025	NJ206R	NU206R	
	41.8	4	8.5	0.6	HJ2206	0.025	NJ2206	NU2206	
	41.4	4	7.5	0.6	HJ2206R	0.025	NJ2206R	NU2206R	
	45.9	5	9.5	1.1	HJ306	0.039	NJ306	NU306	
	45.1	5	8.5	1.1	HJ306R	0.042	NJ306R	NU306R	
	45.9	5	11.5	1.1	HJ2306	0.039	NJ2306	NU2306	
	45.1	5	9.5	1.1	HJ2306R	0.043	NJ2306R	NU2306R	
	50.5	7	11.5	1.5	HJ406	0.080	NJ406	NU406	
	35	47.6	4	8	0.6	HJ207	0.030	NJ207	NU207
		48.2	4	7	0.6	HJ207R	0.033	NJ207R	NU207R
47.6		4	8.5	0.6	HJ2207	0.030	NJ2207	NU2207	

Boundary dimensions (mm)					Thrust collar No.	(Refer.) Mass (kg)	Applicable bearing No.		
d	d_1	B_1	B_2	r_1 min.			NJ	NU	
35	48.2	4	8.5	0.6	HJ2207R	0.035	NJ2207R	NU2207R	
	50.8	6	11	1.1	HJ307	0.056	NJ307	NU307	
	51.1	6	9.5	1.1	HJ307R	0.060	NJ307R	NU307R	
	50.8	6	14	1.1	HJ2307	0.056	NJ2307	NU2307	
	51.1	6	11	1.1	HJ2307R	0.062	NJ2307R	NU2307R	
	59	8	13	1.5	HJ407	0.120	NJ407	NU407	
	40	54.2	5	9	1.1	HJ208	0.046	NJ208	NU208
		54.1	5	8.5	1.1	HJ208R	0.049	NJ208R	NU208R
54.2		5	9.5	1.1	HJ2208	0.046	NJ2208	NU2208	
54.1		5	9	1.1	HJ2208R	0.050	NJ2208R	NU2208R	
58.4		7	12.5	1.5	HJ308	0.083	NJ308	NU308	
57.7		7	11	1.5	HJ308R	0.088	NJ308R	NU308R	
58.4		7	14.5	1.5	HJ2308	0.083	NJ2308	NU2308	
57.7		7	12.5	1.5	HJ2308R	0.091	NJ2308R	NU2308R	
64.8		8	13	2	HJ408	0.140	NJ408	NU408	
45		59	5	9.5	1.1	HJ209	0.053	NJ209	NU209
	59.1	5	8.5	1.1	HJ209R	0.055	NJ209R	NU209R	
	59	5	9.5	1.1	HJ2209	0.053	NJ2209	NU2209	
	59.1	5	9	1.1	HJ2209R	0.055	NJ2209R	NU2209R	
	64	7	12.5	1.5	HJ309	0.099	NJ309	NU309	
	64.5	7	11.5	1.5	HJ309R	0.110	NJ309R	NU309R	
	64	7	15	1.5	HJ2309	0.099	NJ2309	NU2309	
	64.5	7	13	1.5	HJ2309R	0.113	NJ2309R	NU2309R	
	71.8	8	13.5	2	HJ409	0.175	NJ409	NU409	
	50	64.6	5	10	1.1	HJ210	0.063	NJ210	NU210
		64.1	5	9	1.1	HJ210R	0.061	NJ210R	NU210R
64.6		5	9.5	1.1	HJ2210	0.063	NJ2210	NU2210	
64.1		5	9	1.1	HJ2210R	0.061	NJ2210R	NU2210R	
71		8	14	2	HJ310	0.142	NJ310	NU310	

Thrust collars for cylindrical roller bearings

d (50) ~ (65) mm

d (65) ~ (80) mm

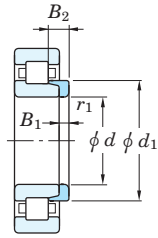

Thrust collar

d	Boundary dimensions (mm)				Thrust collar No.	(Refer.) Mass (kg)	Applicable bearing No.	
	d_1	B_1	B_2	r_1 min.			NJ	NU
50	71.4	8	13	2	HJ310R	0.151	NJ310R	NU310R
	71	8	17	2	HJ2310	0.142	NJ2310	NU2310
	71.4	8	14.5	2	HJ2310R	0.155	NJ2310R	NU2310R
	78.8	9	14.5	2.1	HJ410	0.230	NJ410	NU410
55	70.8	6	11	1.1	HJ211	0.084	NJ211	NU211
	70.9	6	9.5	1.1	HJ211R	0.087	NJ211R	NU211R
	70.8	6	11	1.1	HJ2211	0.084	NJ2211	NU2211
	70.9	6	10	1.1	HJ2211R	0.088	NJ2211R	NU2211R
	77.2	9	15	2	HJ311	0.182	NJ311	NU311
	77.6	9	14	2	HJ311R	0.195	NJ311R	NU311R
	77.2	9	18.5	2	HJ2311	0.182	NJ2311	NU2311
	77.6	9	15.5	2	HJ2311R	0.200	NJ2311R	NU2311R
	85.2	10	16.5	2.1	HJ411	0.290	NJ411	NU411
	60	78.4	6	11	1.5	HJ212	0.108	NJ212
77.7		6	10	1.5	HJ212R	0.108	NJ212R	NU212R
78.4		6	11	1.5	HJ2212	0.108	NJ2212	NU2212
77.7		6	10	1.5	HJ2212R	0.108	NJ2212R	NU2212R
84.2		9	15.5	2.1	HJ312	0.220	NJ312	NU312
84.5		9	14.5	2.1	HJ312R	0.231	NJ312R	NU312R
84.2		9	19	2.1	HJ2312	0.220	NJ2312	NU2312
84.5		9	16	2.1	HJ2312R	0.237	NJ2312R	NU2312R
91.8		10	16.5	2.1	HJ412	0.340	NJ412	NU412
65		84.8	6	11	1.5	HJ213	0.123	NJ213
	84.5	6	10	1.5	HJ213R	0.129	NJ213R	NU213R
	84.8	6	11.5	1.5	HJ2213	0.123	NJ2213	NU2213
	84.5	6	10.5	1.5	HJ2213R	0.131	NJ2213R	NU2213R
	91	10	17	2.1	HJ313	0.280	NJ313	NU313
	90.6	10	15.5	2.1	HJ313R	0.288	NJ313R	NU313R

d	Boundary dimensions (mm)				Thrust collar No.	(Refer.) Mass (kg)	Applicable bearing No.	
	d_1	B_1	B_2	r_1 min.			NJ	NU
65	91	10	20	2.1	HJ2313	0.280	NJ2313	NU2313
	90.6	10	18	2.1	HJ2313R	0.298	NJ2313R	NU2313R
	98.5	11	18	2.1	HJ413	0.420	NJ413	NU413
70	89.6	7	12.5	1.5	HJ214	0.150	NJ214	NU214
	89.5	7	11	1.5	HJ214R	0.157	NJ214R	NU214R
	89.6	7	12.5	1.5	HJ2214	0.150	NJ2214	NU2214
	89.5	7	11.5	1.5	HJ2214R	0.158	NJ2214R	NU2214R
	98	10	17.5	2.1	HJ314	0.330	NJ314	NU314
	97.5	10	15.5	2.1	HJ314R	0.330	NJ314R	NU314R
	98	10	20.5	2.1	HJ2314	0.330	NJ2314	NU2314
	97.5	10	18.5	2.1	HJ2314R	0.345	NJ2314R	NU2314R
	110.5	12	20	3	HJ414	0.605	NJ414	NU414
	75	94	7	12.5	1.5	HJ215	0.156	NJ215
94.5		7	11	1.5	HJ215R	0.166	NJ215R	NU215R
94		7	12.5	1.5	HJ2215	0.156	NJ2215	NU2215
94.5		7	11.5	1.5	HJ2215R	0.167	NJ2215R	NU2215R
104.2		11	18.5	2.1	HJ315	0.400	NJ315	NU315
104.2		11	16.5	2.1	HJ315R	0.410	NJ315R	NU315R
104.2		11	21.5	2.1	HJ2315	0.400	NJ2315	NU2315
104.2		11	19.5	2.1	HJ2315R	0.430	NJ2315R	NU2315R
116		13	21.5	3	HJ415	0.710	NJ415	NU415
80		101.2	8	13.5	2	HJ216	0.207	NJ216
	101.6	8	12.5	2	HJ216R	0.222	NJ216R	NU216R
	101.2	8	13.5	2	HJ2216	0.207	NJ2216	NU2216
	101.6	8	12.5	2	HJ2216R	0.222	NJ2216R	NU2216R
	111.8	11	19.5	2.1	HJ316	0.470	NJ316	NU316
	110.6	11	17	2.1	HJ316R	0.460	NJ316R	NU316R
	111.8	11	23	2.1	HJ2316	0.470	NJ2316	NU2316
	110.6	11	20	2.1	HJ2316R	0.480	NJ2316R	NU2316R

Thrust collars for cylindrical roller bearings

d (80) ~ (100) mm

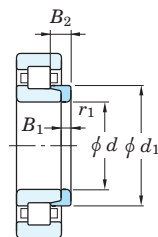

Thrust collar

Boundary dimensions (mm)					Thrust collar No.	(Refer.) Mass (kg)	Applicable bearing No.	
d	d_1	B_1	B_2	r_1 min.			NJ	NU
80	122	13	22	3	HJ416	0.780	NJ416	NU416
85	108.2	8	14	2	HJ217	0.250	NJ217	NU217
	107.6	8	12.5	2	HJ217R	0.250	NJ217R	NU217R
	108.2	8	14	2	HJ2217	0.250	NJ2217	NU2217
	107.6	8	13	2	HJ2217R	0.252	NJ2217R	NU2217R
	117.5	12	20.5	3	HJ317	0.560	NJ317	NU317
	117.9	12	18.5	3	HJ317R	0.575	NJ317R	NU317R
	117.5	12	24	3	HJ2317	0.560	NJ2317	NU2317
	117.9	12	22	3	HJ2317R	0.595	NJ2317R	NU2317R
	126	14	24	4	HJ417	0.880	NJ417	NU417
90	114.2	9	15	2	HJ218	0.305	NJ218	NU218
	114.4	9	14	2	HJ218R	0.320	NJ218R	NU218R
	114.2	9	16	2	HJ2218	0.305	NJ2218	NU2218
	114.4	9	15	2	HJ2218R	0.325	NJ2218R	NU2218R
	125	12	21	3	HJ318	0.630	NJ318	NU318
	124.2	12	18.5	3	HJ318R	0.630	NJ318R	NU318R
	125	12	26	3	HJ2318	0.630	NJ2318	NU2318
	124.2	12	22	3	HJ2318R	0.660	NJ2318R	NU2318R
	137	14	24	4	HJ418	1.05	NJ418	NU418
95	121	9	15.5	2.1	HJ219	0.352	NJ219	NU219
	120.6	9	14	2.1	HJ219R	0.355	NJ219R	NU219R
	121	9	16.5	2.1	HJ2219	0.352	NJ2219	NU2219
	120.6	9	15.5	2.1	HJ2219R	0.365	NJ2219R	NU2219R
	132	13	22.5	3	HJ319	0.760	NJ319	NU319
	132.2	13	20.5	3	HJ319R	0.785	NJ319R	NU319R
	132	13	26.5	3	HJ2319	0.760	NJ2319	NU2319
147	15	25.5	4	HJ419	1.30	NJ419	NU419	
100	128	10	17	2.1	HJ220	0.444	NJ220	NU220

d (100) ~ 120 mm

Boundary dimensions (mm)					Thrust collar No.	(Refer.) Mass (kg)	Applicable bearing No.	
d	d_1	B_1	B_2	r_1 min.			NJ	NU
100	127.5	10	15	2.1	HJ220R	0.435	NJ220R	NU220R
	128	10	18	2.1	HJ2220	0.444	NJ2220	NU2220
	127.5	10	16	2.1	HJ2220R	0.450	NJ2220R	NU2220R
	140.5	13	22.5	3	HJ320	0.895	NJ320	NU320
	139.6	13	20.5	3	HJ320R	0.890	NJ320R	NU320R
	140.5	13	27.5	3	HJ2320	0.895	NJ2320	NU2320
	139.6	13	23.5	3	HJ2320R	0.920	NJ2320R	NU2320R
	153.5	16	27	4	HJ420	1.50	NJ420	NU420
	105	135	10	17.5	2.1	HJ221	0.505	NJ221
147		13	22.5	3	HJ321	0.970	NJ321	NU321
159.5		16	27	4	HJ421	1.65	NJ421	NU421
110	141.5	11	18.5	2.1	HJ222	0.615	NJ222	NU222
	141.7	11	17	2.1	HJ222R	0.620	NJ222R	NU222R
	141.5	11	20.5	2.1	HJ2222	0.615	NJ2222	NU2222
	141.7	11	19.5	2.1	HJ2222R	0.645	NJ2222R	NU2222R
	155.5	14	23	3	HJ322	1.17	NJ322	NU322
	155.8	14	22	3	HJ322R	1.21	NJ322R	NU322R
	155.5	14	28	3	HJ2322	1.17	NJ2322	NU2322
	155.8	14	26.5	3	HJ2322R	1.27	NJ2322R	NU2322R
	171	17	29.5	4	HJ422	2.10	NJ422	NU422
	120	153	11	19	2.1	HJ224	0.715	NJ224
153.4		11	17	2.1	HJ224R	0.710	NJ224R	NU224R
153		11	22	2.1	HJ2224	0.715	NJ2224	NU2224
153.4		11	20	2.1	HJ2224R	0.745	NJ2224R	NU2224R
168.5		14	23.5	3	HJ324	1.40	NJ324	NU324
168.6		14	22.5	3	HJ324R	1.41	NJ324R	NU324R
168.5		14	28	3	HJ2324	1.40	NJ2324	NU2324
168.6		14	26	3	HJ2324R	1.46	NJ2324R	NU2324R
188		17	30.5	5	HJ424	2.60	NJ424	NU424

Thrust collars for cylindrical roller bearings

d 130 ~ (160) mm

d (160) ~ (200) mm

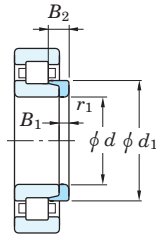

Thrust collar

d	Boundary dimensions (mm)				r_1 min.	Thrust collar No.	(Refer.) Mass (kg)	Applicable bearing No.	
	d_1	B_1	B_2					NJ	NU
130	165.5	11	19	3	HJ226	0.840	NJ226	NU226	
	164.2	11	17	3	HJ226R	0.790	NJ226R	NU226R	
	165.5	11	25	3	HJ2226	0.840	NJ2226	NU2226	
	164.2	11	21	3	HJ2226R	0.840	NJ2226R	NU2226R	
	182	14	24	4	HJ326	1.62	NJ326	NU326	
	182.3	14	23	4	HJ326R	1.65	NJ326R	NU326R	
	182	14	29.5	4	HJ2326	1.62	NJ2326	NU2326	
	182.3	14	28	4	HJ2326R	1.73	NJ2326R	NU2326R	
	205	18	32	5	HJ426	3.30	NJ426	NU426	
140	179.5	11	19	3	HJ228	1.00	NJ228	NU228	
	180	11	18	3	HJ228R	0.990	NJ228R	NU228R	
	179.5	11	25	3	HJ2228	1.00	NJ2228	NU2228	
	180	11	23	3	HJ2228R	1.07	NJ2228R	NU2228R	
	196	15	26	4	HJ328	1.93	NJ328	NU328	
	196	15	25	4	HJ328R	2.04	NJ328R	NU328R	
	196	15	33.5	4	HJ2328	1.98	NJ2328	NU2328	
	196	15	31	4	HJ2328R	2.14	NJ2328R	NU2328R	
	219	18	33	5	HJ428	3.75	NJ428	NU428	
	150	193	12	20.5	3	HJ230	1.24	NJ230	NU230
		193.7	12	19.5	3	HJ230R	1.26	NJ230R	NU230R
193		12	26.5	3	HJ2230	1.24	NJ2230	NU2230	
193.7		12	24.5	3	HJ2230R	1.35	NJ2230R	NU2230R	
210		15	26.5	4	HJ330	2.37	NJ330	NU330	
210		15	25	4	HJ330R	2.35	NJ330R	NU330R	
210		15	34	4	HJ2330	2.37	NJ2330	NU2330	
210		15	31.5	4	HJ2330R	2.48	NJ2330R	NU2330R	
234		20	36.5	5	HJ430	4.70	NJ430	NU430	
160		207	12	21	3	HJ232	1.48	NJ232	NU232
	207.3	12	20	3	HJ232R	1.48	NJ232R	NU232R	

d	Boundary dimensions (mm)				r_1 min.	Thrust collar No.	(Refer.) Mass (kg)	Applicable bearing No.	
	d_1	B_1	B_2					NJ	NU
160	205	12	28	3	HJ2232	1.48	NJ2232	NU2232	
	206.1	12	24.5	3	HJ2232R	1.55	NJ2232R	NU2232R	
	225	15	28	4	HJ332	2.75	NJ332	NU332	
	222.1	15	25	4	HJ332R	2.59	NJ332R	NU332R	
	225	15	37	4	HJ2332	2.75	NJ2332	NU2332	
	222.1	15	32	4	HJ2332R	2.76	NJ2332R	NU2332R	
170	220.5	12	22	4	HJ234	1.70	NJ234	NU234	
	220.8	12	20	4	HJ234R	1.70	NJ234R	NU234R	
	219	12	29	4	HJ2234	1.70	NJ2234	NU2234	
	219.5	12	24	4	HJ2234R	1.79	NJ2234R	NU2234R	
	238	16	29.5	4	HJ334	3.25	NJ334	NU334	
	238	16	38.5	4	HJ2334	3.25	NJ2334	NU2334	
180	230.5	12	22	4	HJ236	1.80	NJ236	NU236	
	230.8	12	20	4	HJ236R	1.79	NJ236R	NU236R	
	229	12	29	4	HJ2236	1.80	NJ2236	NU2236	
	229.5	12	24	4	HJ2236R	1.88	NJ2236R	NU2236R	
	252	17	30.5	4	HJ336	3.85	NJ336	NU336	
	252	17	40	4	HJ2336	3.85	NJ2336	NU2336	
190	244.5	13	23.5	4	HJ238	2.20	NJ238	NU238	
	244.5	13	21.5	4	HJ238R	2.19	NJ238R	NU238R	
	243	13	31.5	4	HJ2238	2.20	NJ2238	NU2238	
	243.2	13	26.5	4	HJ2238R	2.31	NJ2238R	NU2238R	
	265	18	32	5	HJ338	4.45	NJ338	NU338	
	265	18	41.5	5	HJ2338	4.45	NJ2338	NU2338	
200	258	14	25	4	HJ240	2.60	NJ240	NU240	
	258.2	14	23	4	HJ240R	2.65	NJ240R	NU240R	
	258	14	34	4	HJ2240	2.60	NJ2240	NU2240	
	256.9	14	28	4	HJ2240R	2.78	NJ2240R	NU2240R	
	280	18	33	5	HJ340	5.00	NJ340	NU340	

Thrust collars for cylindrical roller bearings

d (200) ~ 320 mm

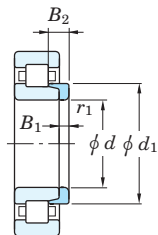

Thrust collar

Boundary dimensions (mm)					Thrust collar No.	(Refer.) Mass (kg)	Applicable bearing No.	
d	d_1	B_1	B_2	r_1 min.			NJ	NU
200	280	18	44.5	5	HJ2340	5.00	NJ2340	NU2340
220	286	15	27.5	4	HJ244	3.55	NJ244	NU244
	286	15	36.5	4	HJ2244	3.55	NJ2244	NU2244
	307	20	36	5	HJ344	7.05	NJ344	NU344
240	313	16	29.5	4	HJ248	4.65	NJ248	NU248
	313	16	38.5	4	HJ2248	4.65	NJ2248	NU2248
	335	22	39.5	5	HJ348	8.20	NJ348	NU348
260	340	18	33	5	HJ252	6.20	NJ252	NU252
	340	18	40.5	5	HJ2252	6.20	NJ2252	NU2252
280	360	18	33	5	HJ256	7.15	NJ256	NU256
300	387	20	34.5	5	HJ260	7.40	NJ260	NU260
320	415	21	37	5	HJ264	11.3	NJ264	NU264

Double-row cylindrical roller bearings

d 25 ~ (110) mm

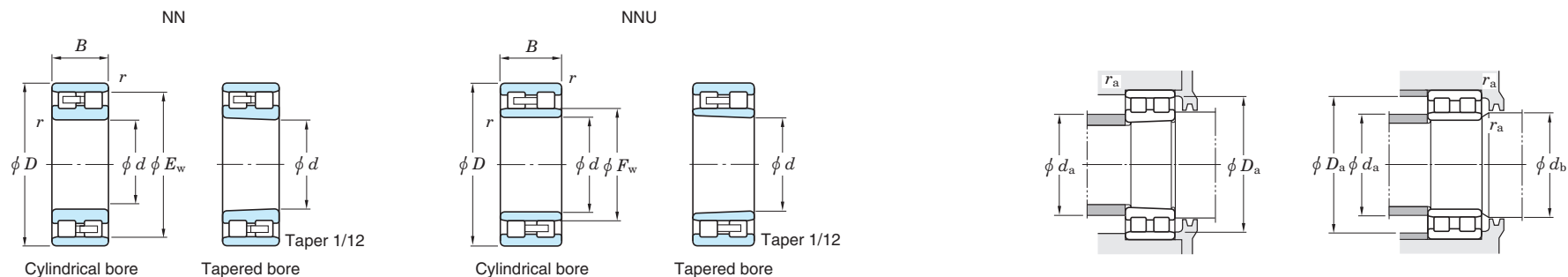

Boundary dimensions (mm)						Basic load ratings (kN)		Fatigue load limit (kN) C_u	Limiting speeds (min^{-1})		Bearing No.		Mounting dimensions (mm)						(Refer.) Mass (kg)				
d	D	B	r_{min}	F_w	E_w	C_r	C_{0r}		Grease lub.	Oil lub.	Cylindrical bore	Tapered bore	Cylindrical bore	Tapered bore	d_a min.	d_a max.	d_b min.	d_b max.	D_a min.	D_a max.	r_a min.	r_a max.	Cylindrical bore
25	47	16	0.6	—	41.3	32.2	30.0	5.20	14 000	17 000	NN3005	NN3005K	—	—	29	—	—	43	42	0.6	—	0.127	0.123
30	55	19	1	—	48.5	46.0	44.1	4.95	12 000	14 000	NN3006	NN3006K	—	—	35	—	—	50	49	1	—	0.198	0.192
35	62	20	1	—	55	49.1	50.0	5.65	10 000	12 000	NN3007	NN3007K	—	—	40	—	—	57	56	1	—	0.253	0.246
40	68	21	1	—	61	52.0	55.9	6.35	9 100	11 000	NN3008	NN3008K	—	—	45	—	—	63	62	1	—	0.307	0.298
45	75	23	1	—	67.5	67.1	71.9	8.75	8 300	9 900	NN3009	NN3009K	—	—	50	—	—	70	69	1	—	0.404	0.382
50	80	23	1	—	72.5	66.4	72.6	8.85	7 600	9 100	NN3010	NN3010K	—	—	55	—	—	75	74	1	—	0.429	0.415
55	90	26	1.1	—	81	89.6	101	13.2	6 800	8 200	NN3011	NN3011K	—	—	61.5	—	—	83.5	82	1	—	0.637	0.618
60	95	26	1.1	—	86.1	91.6	106	13.9	6 400	7 700	NN3012	NN3012K	—	—	66.5	—	—	88.5	87	1	—	0.685	0.664
65	100	26	1.1	—	91	93.6	111	14.6	6 000	7 200	NN3013	NN3013K	—	—	71.5	—	—	93.5	92	1	—	0.728	0.705
70	110	30	1.1	—	100	122	148	20.6	5 500	6 500	NN3014	NN3014K	—	—	76.5	—	—	103.5	101	1	—	1.04	1.02
75	115	30	1.1	—	105	124	155	21.5	5 200	6 200	NN3015	NN3015K	—	—	81.5	—	—	108.5	106	1	—	1.11	1.08
80	125	34	1.1	—	113	149	186	26.6	4 800	5 800	NN3016	NN3016K	—	—	86.5	—	—	118.5	114	1	—	1.55	1.50
85	130	34	1.1	—	118	152	194	27.3	4 600	5 500	NN3017	NN3017K	—	—	91.5	—	—	123.5	119	1	—	1.63	1.58
90	140	37	1.5	—	127	179	228	29.3	4 200	5 100	NN3018	NN3018K	—	—	98	—	—	132	129	1.5	—	2.07	2.01
95	145	37	1.5	—	132	188	246	31.3	4 100	4 900	NN3019	NN3019K	—	—	103	—	—	137	134	1.5	—	2.17	2.10
100	140	40	1.1	113	—	173	258	32.9	4 000	4 800	—	—	—	—	106.5	111	115	133.5	—	1	—	1.95	1.87
	150	37	1.5	—	137	196	265	33.3	3 900	4 700	NN3020	NN3020K	—	—	108	—	—	142	139	1.5	—	2.28	2.21
105	145	40	1.1	118	—	196	306	40.2	3 900	4 600	—	—	—	—	111.5	116	120	138.5	—	1	—	2.00	1.91
	160	41	2	—	146	247	322	42.5	3 700	4 400	NN3021	NN3021K	—	—	114	—	—	151	148	2	—	2.88	2.81
110	150	40	1.1	123	—	204	326	42.4	3 700	4 500	—	—	—	—	116.5	121	125	143.5	—	1	—	2.10	2.01

Double-row cylindrical roller bearings

d (110) ~ (260) mm

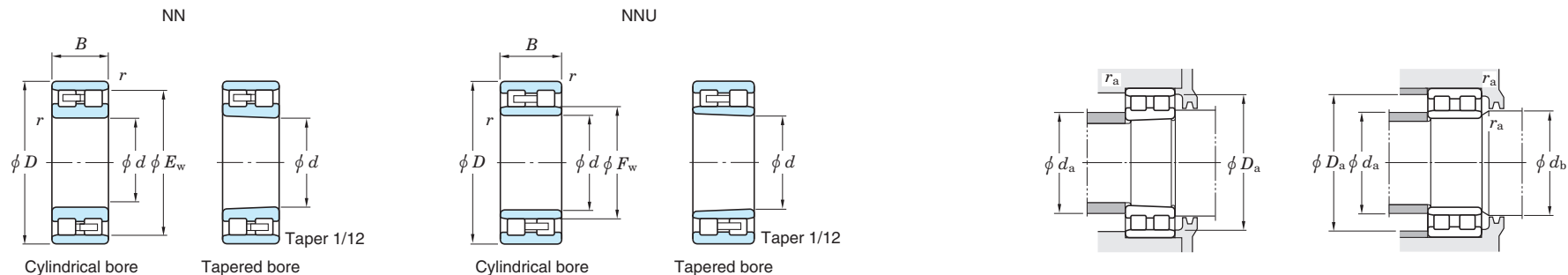

Boundary dimensions (mm)						Basic load ratings (kN)		Fatigue load limit (kN) C_u	Limiting speeds (min ⁻¹)		Bearing No.		Mounting dimensions (mm)						(Refer.) Mass (kg)				
d	D	B	$r_{min.}$	F_w	E_w	C_r	C_{Or}		Grease lub.	Oil lub.	Cylindrical bore	Tapered bore	Cylindrical bore	Tapered bore	d_a min.	d_a max.	d_b min.	d_b max.	D_a min.	D_a max.	r_a min.	r_a max.	Cylindrical bore
110	170	45	2	—	155	278	361	47.9	3 500	4 200	NN3022	NN3022K	—	—	119	—	—	161	157	2	—	3.65	3.56
	165	45	1.1	134.5	—	234	373	47.6	3 400	4 000	—	—	NNU4924	NNU4924K	126.5	132	137	158.5	—	1	—	2.90	2.77
120	180	46	2	—	165	291	392	51.1	3 200	3 900	NN3024	NN3024K	—	—	129	—	—	171	167	2	—	4.00	3.87
	180	50	1.5	146	—	269	428	50.2	3 100	3 700	—	—	NNU4926	NNU4926K	138	143.5	148	172	—	1.5	—	3.90	3.73
130	200	52	2	—	182	356	476	57.7	2 900	3 500	NN3026	NN3026K	—	—	139	—	—	191	183	2	—	5.94	5.76
	190	50	1.5	156	—	277	456	52.5	2 900	3 500	—	—	NNU4928	NNU4928K	148	153.5	158	182	—	1.5	—	4.15	3.97
140	210	53	2	—	192	372	516	61.5	2 700	3 300	NN3028	NN3028K	—	—	149	—	—	201	194	2	—	6.41	6.21
	210	60	2	168.5	—	430	692	80.7	2 600	3 100	—	—	NNU4930	NNU4930K	159	166	171	201	—	2	—	6.50	6.22
150	225	56	2.1	—	206	418	587	70.1	2 500	3 000	NN3030	NN3030K	—	—	161	—	—	214	208	2	—	7.74	7.50
	220	60	2	178.5	—	425	695	79.8	2 500	3 000	—	—	NNU4932	NNU4932K	169	176	182	211	—	2	—	6.95	6.65
160	240	60	2.1	—	219	499	695	79.6	2 400	2 800	NN3032	NN3032K	—	—	171	—	—	229	221	2	—	9.38	9.08
	230	60	2	188.5	—	451	763	86.4	2 300	2 800	—	—	NNU4934	NNU4934K	179	186	192	221	—	2	—	7.20	6.88
170	260	67	2.1	—	236	592	824	105	2 200	2 600	NN3034	NN3034K	—	—	181	—	—	249	238	2	—	12.8	12.4
	250	69	2	202	—	572	964	117	2 100	2 600	—	—	NNU4936	NNU4936K	189	199.5	205	241	—	2	—	10.5	10.1
180	280	74	2.1	—	255	705	958	118	2 000	2 400	NN3036	NN3036K	—	—	191	—	—	269	257	2	—	16.8	16.3
	260	69	2	210	—	581	996	119	2 000	2 400	—	—	NNU4938	NNU4938K	199	207	215	251	—	2	—	11.0	10.5
190	290	75	2.1	—	265	752	1 020	128	1 900	2 300	NN3038	NN3038K	—	—	201	—	—	279	267	2	—	17.6	17.1
	280	80	2.1	223	—	636	1 050	125	1 900	2 300	—	—	NNU4940	NNU4940K	211	219.5	228	269	—	2	—	15.4	14.7
200	310	82	2.1	—	282	793	1 120	137	1 700	2 100	NN3040	NN3040K	—	—	211	—	—	299	285	2	—	22.5	21.8
	300	80	2.1	244	—	701	1 220	145	1 700	2 000	—	—	NNU4944	NNU4944K	231	241	248	289	—	2	—	16.7	16.0
220	340	90	3	—	310	944	1 370	163	1 600	1 900	NN3044	NN3044K	—	—	233	—	—	327	313	2.5	—	29.3	28.4
	320	80	2.1	263	—	736	1 340	155	1 600	1 900	—	—	NNU4948	NNU4948K	251	260	269	309	—	2	—	18.0	17.2
240	360	92	3	—	330	1 090	1 590	184	1 400	1 700	NN3048	NN3048K	—	—	253	—	—	347	333	2.5	—	32.8	31.8
	260	360	100	2.1	287	—	1 180	2 050	228	1 400	1 700	—	—	NNU4952	NNU4952K	271	284	296	349	—	2	—	31.4

Double-row cylindrical roller bearings

d (260) ~ 460 mm

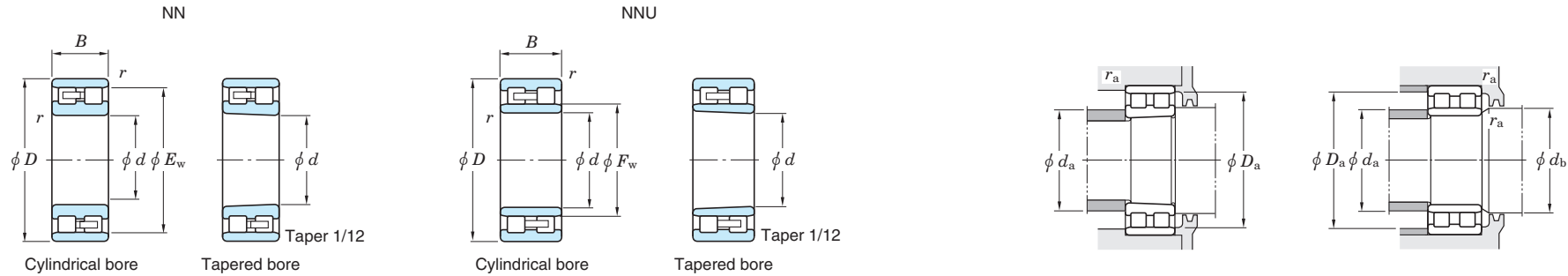

Boundary dimensions (mm)						Basic load ratings (kN)		Fatigue load limit (kN) C_u	Limiting speeds (min ⁻¹)		Bearing No.		Mounting dimensions (mm)						(Refer.) Mass (kg)			
d	D	B	$r_{min.}$	F_w	E_w	C_r	C_{0r}		Grease lub.	Oil lub.	Cylindrical bore	Tapered bore	Cylindrical bore	Tapered bore	d_a min.	d_a max.	d_b min.	d_b max.	D_a min.	r_a max.	Cylindrical bore	Tapered bore
260	400	104	4	—	364	1 290	1 830	204	1 300	1 500	NN3052	NN3052K	—	—	276	—	—	384	367	3	47.4	46.0
280	380	100	2.1	308	—	1 220	2 200	239	1 300	1 500	—	—	NNU4956	NNU4956K	291	305	316	369	—	2	33.1	31.6
	420	106	4	—	384	1 370	2 010	220	1 200	1 400	NN3056	NN3056K	—	—	296	—	—	404	387	3	51.2	49.6
300	420	118	3	339	—	1 470	2 720	285	1 100	1 300	—	—	NNU4960	NNU4960K	313	335	343	407	—	2.5	51.9	49.7
	460	118	4	—	418	1 610	2 460	266	1 100	1 300	NN3060	NN3060K	—	—	316	—	—	444	421	3	70.8	68.7
320	440	118	3	352	—	1 530	2 750	286	1 100	1 300	—	—	NNU4964	NNU4964K	333	348	363	427	—	2.5	53.7	51.4
	480	121	4	—	438	1 690	2 670	283	980	1 200	NN3064	NN3064K	—	—	336	—	—	464	442	3	76.4	74.0
340	460	118	3	372	—	1 580	2 930	301	990	1 200	—	—	NNU4968	NNU4968K	353	368	383	447	—	2.5	56.8	54.3
	520	133	5	—	473	2 090	3 090	345	880	1 100	NN3068	NN3068K	—	—	360	—	—	500	477	4	101	97.8
360	540	134	5	—	493	1 950	3 090	315	830	990	NN3072	NN3072K	—	—	380	—	—	520	497	4	107	104
380	560	135	5	—	510	2 050	3 350	337	780	940	NN3076	NN3076K	—	—	400	—	—	540	514	4	113	109
400	600	148	5	—	548	2 550	4 140	414	700	850	NN3080	NN3080K	—	—	420	—	—	580	552	4	146	141
420	620	150	5	—	570	2 900	4 570	449	670	800	NN3084	NN3084K	—	—	440	—	—	600	574	4	154	149
440	650	157	6	—	597	3 160	5 060	489	620	740	NN3088	NN3088K	—	—	464	—	—	626	602	5	177	171
460	680	163	6	—	627	3 390	5 480	521	570	690	NN3092	NN3092K	—	—	484	—	—	656	632	5	201	195

Tapered roller bearings

Tapered roller bearings are designed such that outer ring, inner ring and rollers have tapered surfaces whose apexes converge at a common point on the bearing axis. Along with metric series bearings, inch series bearings are also available.

This type of bearing is suitable for applications that involve heavy or impact loading.

■ Single-row tapered roller bearings

- Able to carry radial and axial load in one direction simultaneously.

Because an axial component of force is produced when this type of bearing is loaded radially, two bearings are used together facing one another, or two or more bearings are matched and used.

- There are the standard, medium and steep type which are different in contact angle size.

Medium-tapered metric series bearings are identified by the supplementary code "C" which is added as a suffix to bearing numbers.

- Bearings whose outer ring width, outer ring small inside diameter and contact angle are determined in accordance with ISO 355 specifications are identified by the supplementary code "J" as a suffix.

Inner ring assemblies and the outer rings of such bearings are interchangeable with those of bearings produced abroad if the bearing numbers are the same.

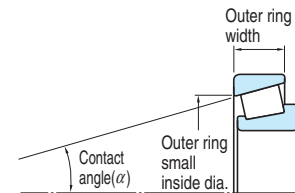

ISO sub-unit specifications

■ Double-row tapered roller bearings

- These bearings are divided into the TDO type which has one double outer ring and two single-row inner rings, and the TDI type which has two single-row outer rings and one double inner ring. Both accommodate radial and axial loading in both directions.

These two also carry moment loads, however, the TDO type is superior to the TDI type, because the distance between load centers (α) is longer in the TDO type.

- The spacer of the TDO type, or the TDI type, pre-adjusts the internal clearance to provide proper operating clearance after mounting.

Single-row tapered roller bearings



Metric series

Bore diameter **15 – 360 mm**



Inch series

(including J series metric bearing)

Bore diameter **9.525 – 292.100 mm**

Double-row tapered roller bearings

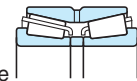

TDO type

Bore diameter **25 – 500 mm**

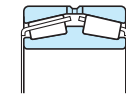

TDI type

Bore diameter **100 – 500 mm**

[Note] When supplementary code "J" is added as a prefix (not a suffix) to bearing numbers (e.g. JHM720249/JHM720210), the bearings are not designed according to ISO 355. Such bearings are called "J series metric tapered roller bearings," and are produced according to special tolerances.



Boundary dimensions	<p>Metric single-row tapered roller bearings : as specified in JIS B 1512.</p> <p>Reference JIS B 1512 specifies new dimension series which are based on ISO 355, as well as the conventional "3XX" dimension series. These new dimension series are as follows :</p> <p style="text-align: center;">New dimension series</p> <div style="display: flex; justify-content: space-around;"> <div style="width: 45%;"> <p>(1) Angle series</p> <table border="1" style="width: 100%;"> <thead> <tr> <th rowspan="2">Angle series</th> <th colspan="2">Contact angle α</th> </tr> <tr> <th>over</th> <th>up to</th> </tr> </thead> <tbody> <tr><td>2</td><td>10°</td><td>13° 52'</td></tr> <tr><td>3</td><td>13° 52'</td><td>15° 59'</td></tr> <tr><td>4</td><td>15° 59'</td><td>18° 55'</td></tr> <tr><td>5</td><td>18° 55'</td><td>23°</td></tr> <tr><td>6</td><td>23°</td><td>27°</td></tr> <tr><td>7</td><td>27°</td><td>30°</td></tr> </tbody> </table> </div> <div style="width: 45%;"> <p>(3) Width series</p> <table border="1" style="width: 100%;"> <thead> <tr> <th rowspan="2">Width series</th> <th colspan="2">$T/\{(D-d)^{0.95}\}$</th> </tr> <tr> <th>over</th> <th>up to</th> </tr> </thead> <tbody> <tr><td>B</td><td>0.50</td><td>0.68</td></tr> <tr><td>C</td><td>0.68</td><td>0.80</td></tr> <tr><td>D</td><td>0.80</td><td>0.88</td></tr> <tr><td>E</td><td>0.88</td><td>1.00</td></tr> </tbody> </table> </div> </div> <div style="margin-top: 10px;"> <p>(2) Diameter series</p> <table border="1" style="width: 100%;"> <thead> <tr> <th rowspan="2">Diameter series</th> <th colspan="2">$D/(d^{0.77})$</th> </tr> <tr> <th>over</th> <th>up to</th> </tr> </thead> <tbody> <tr><td>B</td><td>3.40</td><td>3.80</td></tr> <tr><td>C</td><td>3.80</td><td>4.40</td></tr> <tr><td>D</td><td>4.40</td><td>4.70</td></tr> <tr><td>E</td><td>4.70</td><td>5.00</td></tr> <tr><td>F</td><td>5.00</td><td>5.60</td></tr> <tr><td>G</td><td>5.60</td><td>7.00</td></tr> </tbody> </table> </div> <p>[Remarks] 1. Combine these series symbols in the listed order to make the dimension series numbers. (ex. 2BC) 2. Bearing numbers consist of a dimension series number and a bore diameter which is added as a suffix. (ex. 2BC080 : bore diameter 80 mm)</p>	Angle series	Contact angle α		over	up to	2	10°	13° 52'	3	13° 52'	15° 59'	4	15° 59'	18° 55'	5	18° 55'	23°	6	23°	27°	7	27°	30°	Width series	$T/\{(D-d)^{0.95}\}$		over	up to	B	0.50	0.68	C	0.68	0.80	D	0.80	0.88	E	0.88	1.00	Diameter series	$D/(d^{0.77})$		over	up to	B	3.40	3.80	C	3.80	4.40	D	4.40	4.70	E	4.70	5.00	F	5.00	5.60	G	5.60	7.00
Angle series	Contact angle α																																																															
	over	up to																																																														
2	10°	13° 52'																																																														
3	13° 52'	15° 59'																																																														
4	15° 59'	18° 55'																																																														
5	18° 55'	23°																																																														
6	23°	27°																																																														
7	27°	30°																																																														
Width series	$T/\{(D-d)^{0.95}\}$																																																															
	over	up to																																																														
B	0.50	0.68																																																														
C	0.68	0.80																																																														
D	0.80	0.88																																																														
E	0.88	1.00																																																														
Diameter series	$D/(d^{0.77})$																																																															
	over	up to																																																														
B	3.40	3.80																																																														
C	3.80	4.40																																																														
D	4.40	4.70																																																														
E	4.70	5.00																																																														
F	5.00	5.60																																																														
G	5.60	7.00																																																														
Tolerances	<ul style="list-style-type: none"> · Metric series single-row tapered roller bearings as specified in JIS B 1514-1. (refer to Table 7-5 on pp. A 66 – A 68.) · Metric series double-row tapered roller bearings as specified in BAS 1002. (refer to Table 7-6 on p. A 69.) · Inch series tapered roller bearings as specified in ABMA Section 19. (refer to Table 7-7 on pp. A 70, 71.) · J series metric tapered roller bearings the tolerance is specified separately. (refer to Table 7-8 on pp. A 72, 73.) 																																																															
Internal clearance	Radial internal clearance of double-row, four-row and matched pair tapered roller bearings (refer to Table 10-10 on p. A 110.)																																																															
Recommended fits	<ul style="list-style-type: none"> · Metric series tapered roller bearings (classes 0, 6X and 6) (refer to Table 9-4 on pp. A 91, 92.) · Inch series tapered roller bearings (refer to Table 9-7 on pp. A 96, 97.) · J series metric tapered roller bearings (refer to Table 9-6 on pp. A 94, 95.) 																																																															
Standard cage	Pressed cage (supplementary code : //) (Some large size bearings have a pin type cage (FP) instead.) (They are listed separately in the bearing specification table.)																																																															

Allowable misalignment	Single-row tapered roller bearings : 0.000 9 rad (3') (If the misalignment exceeds this angle size, JTEKT is ready to design special bearings to order.)
Equivalent radial load	<ul style="list-style-type: none"> ■ Single-row tapered roller bearings <ul style="list-style-type: none"> Dynamic equivalent radial load $\left(\text{when } \frac{F_a}{F_r} \leq e \right) P_r = F_r$ $\left(\text{when } \frac{F_a}{F_r} > e \right) P_r = 0.4F_r + Y_1 F_a$ Static equivalent radial load $P_{0r} = 0.5F_r + Y_0 F_a$ when $P_{0r} < F_r, P_{0r} = F_r$ [Note] Refer to the bearing specification table for the values of axial load factors Y_1, Y_2, Y_3 and Y_0 and constant e. ■ Double-row or four-row tapered roller bearings <ul style="list-style-type: none"> Dynamic equivalent radial load $\left(\text{when } \frac{F_a}{F_r} \leq e \right) P_r = F_r + Y_2 F_a$ $\left(\text{when } \frac{F_a}{F_r} > e \right) P_r = 0.67F_r + Y_3 F_a$ Static equivalent radial load $P_{0r} = F_r + Y_0 F_a$
[Remarks]	1. When two single-row tapered roller bearings are used together facing one another, an axial component of force is produced under radial load. In this case, refer to pp. A 38, 39 for calculation of the dynamic equivalent radial load. 2. When the load is too small, slippage occurs between the rollers and raceways, causing smearing to develop. This also occurs to matched pair bearings when the ratio of axial load to radial load exceeds the value e shown in the specification table ($F_a/F_r > e$). Consult with JTEKT on use of bearings under such conditions.

[Series No. index]

series No.	inner ring	pages	outer ring	pages			
335	336	B237	332	B233,B235, B237			
	339	B233					
	342	B237					
	344	B235					
	344A	B237					
355	350A	B237	354A	B237,B239, B241			
	355	B239					
	355A	B239					
	358	B239					
	359A	B241					
359S	B241						
365	365	B243	362A	B237,B241, B243,B245			
	365A	B237					
	365S	B241					
	366	B243					
	368	B243					
	368A	B243					
	368S	B245					
	369A	B241					
	370A	B243					
	375	375			B243	374	B243
	385	385			B247	382 382A	B247 B241,B243, B247
385AX		B243					
385X		B247					
386A		B241					
387		B247					
387A		B247					
387AS		B247					
387S		B247					
388A		B247					
389		B247					
395		390A	B249	394A	B243,B249, B251		
		392	B249				
		395	B249				
	395A	B251					
	395S	B251					
	396	B243					
	397	B249					
	399A	B251					
	399AS	B251					
	415	418	B235			414	B235,B237
419		B237					
420		B237					
435	438	B239	432	B233			
	449	B233	432A	B239			
455 (Continued)	456	B245	453X	B241,B245, B247			
	462	B247					
	463	B241					
	466	B245					

series No.	inner ring	pages	outer ring	pages			
455	467	B241					
	468	B245					
	469	B247					
475	477	B249	472	B249,B253			
	482	B253	472A	B253			
			472X	B253			
495	495	B257	492A 493	B255,B257, B259 B255,B259			
	495A	B255					
	495AX	B255					
	496	B257					
	497	B259					
	497A	B259					
	498	B259					
	525	525			B235	522	B235,B237, B239,B241, B243
		526			B237		
	527	B239					
	528	B241					
	529	B243					
	529X	B243					
535	535	B239	532A	B239			
	537	B245	532X	B237,B245			
	539	B245					
	539A	B245					
	543	B237					
555	557S	B245	552A	B245			
565	565	B249	563	B249,B251, B253,B256			
	566	B253					
	567	B253					
	567A	B253					
	568	B256					
	570	B251					
	575R	575R			B255	572	B253,B255, B257 B257
		575SR			B255		
		576R			B253		
577R		B255					
580R		B257					
581R		B257					
582R		B257					
595	594A	B261	592A	B259			
	596	B259	592XE	B261			
615	615	B239	612	B239,B245, B247			
	619	B245					
	621	B245					
	623	B247					
	635	641			B251	633	B251
655 (Continued)	655	B253	652	B255			
	657	B255					
	659	B255					
	661	B257					
					653	B253,B255, B257,B259	

series No.	inner ring	pages	outer ring	pages			
655	663	B257					
	665	B259					
	665A	B259					
675	677	B259	672	B259,B261, B263			
	679	B259					
	681	B261					
	681A	B261					
	683	B261					
	685	B261					
	687	B263					
745R	740R	B257	742	B253,B255, B257,B259			
	744R	B255					
	745AR	B253					
	748SR	B255					
	749AR	B257					
	749R	B259					
	749SR	B259					
750AR	B257						
755	756A	B257	752	B255,B257, B259,B261			
	757	B257					
	758	B259					
	759	B259					
	760	B261					
	762	B255					
	766	B259					
	775	778			B261	772	B261,B263
780		B263					
782		B263					
786		B263					
787		B263					
835R		835R	B253	832	B253,B259		
		841R	B259				
855R	855R	B259	854	B259,B261, B263			
	857R	B261					
	861R	B263					
	864R	B261					
935	936	B265	932	B263,B265			
	938	B265					
	941	B263					
1200	1280	B227	1220	B227			
1300	1380	B225	1328	B225			
			1329	B225			
1700	1755	B227	1729	B227			
	1779	B227					
1900R	1986R	B227	1922	B229			
	1988R	B229					
A2000	A2037	B225	A2126	B225			
	A2047	B225					
2500	2580	B231	2520	B231			

series No.	inner ring	pages	outer ring	pages
2600	2682	B227	2631	B227,B229
	2684	B227		
	2687	B227		
	2688	B229		
	2689	B229		
2690	B229			
2700R	2788R	B235	2720	B233
	2789R	B235		
	2794R	B233		
	2796R	B233		
2900	2984	B241	2924	B241
3100	3192	B229	3120	B229
	3198	B229		
3300	3382	B235	3320	B235
	3386	B235		
3400	3478	B233	3420	B233,B235
	3479	B233		
	3490	B235		
3500R	3576R	B237	3520	B239
	3578R	B239		
	3581R	B233		
3700	3776	B239	3720	B239,B243
	3780	B243		
			3730	B243
			3732	B243
3800	3877	B237	3820	B233
	3878	B233		
3900	3979	B247	3920	B247
	3984	B251		
		3925		
A4000	A4050	B225	A4138	B225
	A4059	B225		
4300	4375	B235	4335	B235,B237
	4388	B237		
	4395	B237		
4500	4580	B245	4535	B245
	4595	B245		
5500R	5566R	B247	5535	B245,B247, B249,B251
	5578R	B245		
	5583R	B249		
	5584R	B249		
	5595R	B251		
5700	5760	B255	5735	B255
6300	6379	B251	6320	B245,B249, B251
	6381	B245		
	6382	B249		
	6386	B251		
	6389	B251		
6400	6460	B255	6420	B255
	6461	B255		
	6461A	B255		

series No.	inner ring	pages	outer ring	pages
6500R	6580R	B259	6535	B259,B261
	6581XR	B261		
9100	9185	B251	9121	B251
02400	02473	B227	02420	B227,B229, B231
	02474	B229		
	02475	B231		
	02476	B231		
02800	02872	B229	02820	B229,B231, B233
	02875	B231		
	02876	B231		
	02877	B233		
	02878	B233		
	03062	B225		
07000	07079	B225	07196 07204	B225,B227 B227
	07097	B227		
	07098	B227		
	07100	B227		
	07100S	B227		
	08000	08125		
09000	09062	B225	09195	B225
	09067	B225	09196	B225
	09078	B225		
11000R	11162R	B237	11300	B237
LM11700R	LM11749R	B225	LM11710	B225
LM11900	LM11949	B225	LM11910	B225
12000	12168	B239	12303	B239
	12175	B239		
12500	12580	B225	12520	B225
M12600	M12648	B225	M12610	B225
	M12649	B225		
LM12700	LM12749	B225	LM12711	B225
13600	13687	B235	13621	B235
13800	13889	B233,B235	13830	B233
			13836	B235
14000	14116	B231	14274	B231
	14117A	B229	14276	B229,B231
	14136A	B231		
	15100	B227	15243	B227
(Continued)	15101	B227	15245	B227,B229, B231
	15106	B229		
	15112	B229		
	15113	B229		
	15116	B229		
	15117	B229		
	15118	B231		
	15119	B231		
	15120	B231		
	15123	B231		
	15125	B231		

series No.	inner ring	pages	outer ring	pages		
15000	15126	B231				
15500	15580	B229	15520	B229		
	15590	B229	15523	B229		
16000	16137	B233	16282	B235		
	16150	B235	16283	B235		
				16284	B233	
17000	17098	B227	17244	B227,B229		
	17118	B229				
	17119	B229				
17500R	17580R	B225	17520	B225		
18000	18200	B243	18337	B243		
18500	18587	B235	18520	B235,B237		
	18590	B237				
18600	18685	B239	18620	B239,B241		
	18690	B241				
18700	18790	B243	18724	B243		
19000R	19150R	B235	19281	B235		
			19283	B235		
21000	21063	B225	21212	B225		
L21500	L21549	B225	L21511	B225		
23600	23690	B233	23620	B233		
24700R	24780R	B237	24720	B237		
25500	25572	B235	25520	B235,B239		
	25577	B239				
	25582	B239				
25800R	25877R	B233	25821	B233		
	25880R	B233				
26000	26112	B229	26283	B229,B231		
	26131	B231				
	26877R	B233				
26800R	26883R	B233	26822	B233,B239		
	26884R	B239				
	27600	B257			27620	B257,B259
	27689	B257				
27690	B259					
27800	27691	B259	27820	B235		
	27880	B235				
	27881	B235				
28000	28137	B233	28300	B233,B235		
	28150	B235				
	28158	B235				
	28500R	B243				
28500R	28579R	B243	28521	B243,B245		
	28580R	B243				
	28584R	B245				
28600	28678	B243	28622	B243,B247		
	28680	B247				
28900	28985	B249	28920	B249		
					28921	B249

series No.	inner ring	pages	outer ring	pages
29500	29580	B249	29520	B249
	29585	B249		
	29586	B249		
29600	29675	B253	29620	B253,B255
	29685	B253		
	29688	B255		
LM29700	LM29748	B235	LM29710	B235
	LM29749	B235	LM29711	B235
31500	31594	B233	31520	B233
33000	33225	B247	33462	B247,B251, B253
		B251		
		B251		
		B253		
		B253		
		B253		
33800	33885	B239	33821	B239
	33889	B243		
	33895	B245		
34000	34274	B253	34478	B253,B255, B257
	34301	B255		
	34306	B257		
	34307	B257		
37000	37425	B263	37625	B263,B265
	37431	B265		
39500	39575	B245	39520	B245,B247, B249,B251
	39580	B247		
	39581	B247		
	39585	B249		
	39586	B249		
	39590	B251		
41000	41125	B229	41286	B229
	41126	B229		
42600	42687	B255	42620	B255,B257
	42688	B255		
	42690	B257		
L44600R	L44640R	B227	L44610	B227
	L44643R	B227		
	L44649R	B227		
45200	45282	B241	45220	B241,B243
	45284	B243		
	45291	B247		
46000	46162	B237	46368	B237,B239
	46175	B239		
	46176	B239		
47400R	47487R	B253	47420	B253
	47490R	B253		
47600R	47678R	B255	47620	B255,B257
	47680R	B255		
	47681R	B257		

series No.	inner ring	pages	outer ring	pages
47600R	47686R	B257		
47800R	47890R	B261	47820	B261
	47896R	B261		
48100	48190	B263	48120	B263
LM48500	LM48548	B231	LM48510	B231
48600	48684	B267	48620	B267
	48685	B267		
49000	49175	B239	49368	B239
49500	49576	B239	49520	B239,B243
	49585	B243		
52000	52375	B261	52618	B261,B263
	52393	B263		
	52400	B263		
	52401	B263		
56000R	56418R	B263	56650	B263
	56425R	B263		
59000	59200	B243	59412	B243
64000R	64433R	B265	64700	B265
	64450R	B265		
65000	65200	B245	65500	B245,B247, B249
	65212	B245		
	65225	B247		
	65237	B249		
	65237A	B249		
65300	65390	B241	65320	B241
66000R	66212R	B245	66462	B245
66500	66584	B245	66520	B245,B247
	66589	B247		
LM67000	LM67048	B231	LM67010	B231
68000	68450	B265	68712	B265
	68462	B265		
	68463	B265		
L68100	L68149	B233	L68110	B233
71000	71412	B263	71750	B263,B265
	71425	B263		
	71450	B265		
	71453	B265		
	71455	B265		
LM72800	LM72849	B227	LM72810	B227
HM81600	HM81649	B225	HM81610	B225
M84200	M84249	B227	M84210	B227
M86600R	M86643R	B227	M86610	B227,B229
	M86647R	B229		
	M86649R	B229		
M88000	M88043	B231	M88010	B231
	M88046	B231		
	M88048	B231		

series No.	inner ring	pages	outer ring	pages
HM88500	HM88542	B231	HM88510	B231
	HM88547	B231	HM88512	B231
HM88600	HM88630	B227	HM88610	B227, B231,
	HM88648	B233		B233
	HM88649	B231		
HM89400	HM89443	B231	HM89410	B231
	HM89449	B233	HM89411	B233
98000	98316	B257	98788	B257, B259,
	98335	B259		B261, B263
	98350	B261		
	98400	B263		
L102800	L102849	B239	L102810	B239
LM102900	LM102949	B241	LM102910	B241
LM104900	LM104949	B243	LM104911	B243
HM212000	HM212046	B249	HM212010	B251
	HM212049	B251	HM212011	B249
L217800	L217849	B259	L217810	B259
HM218200	HM218248	B261	HM218210	B261
HH221400	HH221430	B255	HH221410	B255, B257,
	HH221431	B257		B261, B263
	HH221434	B261		
	HH221440	B261		
	HH221442	B261		
	HH221447	B263		
	HH221449	B263		
HH224300	HH224334	B261	HH224310	B261, B263,
	HH224335	B263		B265
	HH224340	B265		
	HH224346	B265		
	HH224349	B265		
HH228300	HH228340	B265	HH228310	B265
	HH228349	B265		
LM245800	LM245833	B267	LM245810	B267
	LM245846	B267		
	LM245848	B267		
M246900	M246942	B267	M246910	B267
M249700	M249732	B267	M249710	B267
	M249734	B267		
	M249749	B267		
L305600R	L305649R	B243	L305610	B243
L319200	L319249	B261	L319210	B261
LL319300	LL319349	B261	LL319310	B261
L327200	L327249	B267	L327210	B267
M349500	M349549	B267	M349510	B267
H414200	H414235	B249	H414210	B249, B251,
	H414242	B251		B253
	H414245	B251		
	H414249	B253		
L435000	L435049	B267	L435010	B267

series No.	inner ring	pages	outer ring	pages
LM501300	LM501349	B237	LM501310	B237
			LM501311	B237
			LM501314	B237
LM503300R	LM503349R	B241	LM503310	B241
HH506300	HH506348	B241	HH506310	B241
HM516400	HM516448	B257	HM516410	B257
HM518400	HM518445	B259	HM518410	B259
L521900R	L521949R	B263	L521910	B263
LM522500	LM522546	B263	LM522510	B263, B265
	LM522548	B265		
	LM522549	B265		
L540000	L540049	B267	L540010	B267
L555200	L555249	B267	L555210	B267
LM603000	LM603049	B241	LM603011	B241
			LM603012	B241
			LM603014	B241
LM613400	LM613449	B253	LM613410	B253
HM617000	HM617049	B259	HM617010	B259
HM624700	HM624749	B265	HM624710	B265
LL713000	LL713049	B253	LL713010	B253
H715300	H715332	B249	H715311	B249, B251,
	H715340	B251		B253
	H715341	B251		
	H715343	B251		
	H715345	B253		
HM801300	HM801346	B235	HM801310	B235, B237
	HM801346X	B235		
	HM801349	B237		
M802000	M802048	B237	M802011	B237
HM803100	HM803145	B237	HM803110	B237, B239
	HM803146	B237		
	HM803149	B239		
M804000	M804049	B241	M804010	B241
HM804800	HM804840	B237	HM804810	B237, B239,
	HM804842	B239		B241
	HM804843	B239		
	HM804846	B241		
	HM804848	B241		
LM806600	LM806649	B245	LM806610	B245
HM807000	HM807035	B237	HM807010	B237, B239,
	HM807040	B239		B241, B245
	HM807044	B241		
	HM807046	B245		
	HM807049	B245		
HM813800	HM813840	B247	HM813810	B247, B249
	HM813841	B249	HM813811	B249, B251,
	HM813841A	B249		B253
	HM813844	B251		

series No.	inner ring	pages	outer ring	pages
HM813800	HM813849	B253		
LM814800	LM814849	B257	LM814810	B257
HH926700	HH926744	B265	HH926710	B265

Metric J series

series No.	inner ring	pages	outer ring	pages
JL69300	JL69349	B233	JL69310	B233
JLM104900	JLM104948	B243	JLM104910	B243
JM205100	JM205149	B243	JM205110	B243
JM207000	JM207049	B247	JM207010	B247
JH211700	JH211749	B251	JH211710	B251
	JH211749A	B251		
JH217200	JH217249	B259	JH217210	B259
JH307700	JH307749	B247	JH307710	B247
JHM318400	JHM318448	B261	JHM318410	B261
JH415600	JH415647	B255	JH415610	B255
JLM506800	JLM506849	B245	JLM506810	B245
JLM508700	JLM508748	B247	JLM508710	B247
JM511900	JM511946	B249	JM511910	B249
JM515600	JM515649	B257	JM515610	B257
JHM516800	JHM516849	B259	JHM516810	B259
JHM522600	JHM522649	B265	JHM522610	B265
JHM534100	JHM534149	B267	JHM534110	B267
JM612900	JM612949	B253	JM612910	B253
JLM710900	JLM710949	B249	JLM710910	B249
JLM714100	JLM714149	B255	JLM714110	B255
JM714200	JM714249	B255	JM714210	B255
JM716600	JM716649	B259	JM716610	B259
JM718100	JM718149	B261	JM718110	B261
JM719100	JM719149	B261	JM719113	B261
JHM720200	JHM720249	B263	JHM720210	B263
JM720200	JM720249	B263	JM720210	B263
JM734400	JM734449	B267	JM734410	B267
JM736100	JM736149	B267	JM736110	B267
JM738200	JM738249	B267	JM738210	B267
JHM807000	JHM807045	B243	JHM807012	B243
JLM813000	JLM813049	B253	JLM813010	B253
JM822000	JM822049	B265	JM822010	B265
JHM840400	JHM840449	B267	JHM840410	B267

Single-row tapered roller bearings
metric series

d 15 ~ 22 mm

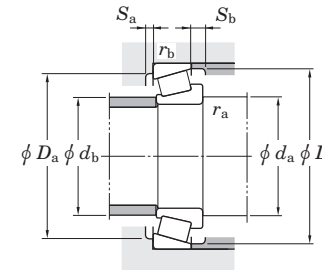
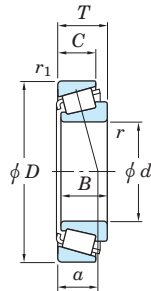

Boundary dimensions (mm)						Basic load ratings (kN)		Fatigue load limit (kN) C _u	Limiting speeds (min ⁻¹)		Bearing No. 1)	Dimension series to ISO355 (Refer.)	Load center (mm) a	Mounting dimensions (mm)								Constant e	Axial load factors		(Refer.) Mass (kg)	
d	D	T	B	C	r _{min.}	r _{1 min.}	C _r		C _{0r}	Grease lub.				Oil lub.	d _{a min.}	d _{b max.}	D _{a max.}	D _{b min.}	S _{a min.}	S _{b min.}	r _{a max.}		r _{b max.}	Y ₁		Y ₀
15	35	11.75	11	10	0.6	0.6	19.8	14.5	2.00	12 000	16 000	—	8.3	19.5	20	30.5	29	33	2	1.7	0.6	0.6	0.32	1.88	1.04	0.054
	42	14.25	13	11	1	1	27.4	19.2	2.65	10 000	14 000	2FB	10.0	20.5	22	36.5	35	38	2	3	1	1	0.29	2.11	1.16	0.098
17	40	13.25	12	11	1	1	26.0	20.7	2.85	10 000	14 000	2DB	10.1	22.5	23	34.5	33	37	2	2	1	1	0.35	1.74	0.96	0.081
	40	17.25	16	14	1	1	34.3	27.5	3.85	10 000	14 000	2DD	11.4	22.5	23	34.5	33	37	2	3	1	1	0.31	1.92	1.06	0.104
	47	15.25	14	12	1	1	34.2	24.5	3.45	9 200	12 000	2FB	11.0	22.5	25	41.5	40	42	2	3	1	1	0.29	2.11	1.16	0.133
	47	15.25	14	12	1	1	34.2	24.5	3.45	9 200	12 000	—	10.5	22.5	25	41.5	40	42	2	3	1	1	0.28	2.11	1.16	0.127
	47	20.25	19	16	1	1	39.9	29.9	4.25	9 400	13 000	—	12.4	22.5	25	41.5	39	43	2	4	1	1	0.28	2.11	1.16	0.170
	47	20.25	19	16	1	1	45.7	35.9	5.10	9 400	13 000	2FD	12.2	22.5	25	41.5	39	43	2	4	1	1	0.29	2.11	1.16	0.176
20	42	15	15	12	0.6	0.6	34.1	31.5	4.35	9 700	13 000	3CC	10.5	24.5	25	37.5	35	39	3	3	0.6	0.6	0.37	1.60	0.88	0.102
	47	15.25	14	12	1	1	34.2	25.5	3.75	9 000	12 000	—	12.9	25.5	26	41.5	37	44	2	3	1	1	0.52	1.16	0.64	0.125
	47	15.25	14	12	1	1	33.8	27.2	3.80	8 700	12 000	2DB	11.8	25.5	27	41.5	39	44	2	3	1	1	0.35	1.74	0.96	0.127
	47	19.25	18	15	1	1	41.4	34.7	4.90	8 900	12 000	2DD	12.5	25.5	27	41.5	39	43	2	4	1	1	0.33	1.81	1.00	0.159
	47	19.25	18	16	1	1	41.6	37.0	5.00	9 100	12 000	—	15.3	25.5	25	41.5	35	45	2	3	1	1	0.55	1.10	0.60	0.170
	52	16.25	16	12	1.5	1.5	43.3	28.4	4.65	8 300	11 000	—	13.5	28.5	28	43.5	42	49	4	4	1.5	1.5	0.55	1.10	0.60	0.170
	52	16.25	16	13	1.5	1.5	45.3	35.1	5.05	8 300	11 000	—	11.1	28.5	28	44	44	47	2	3	1.5	1.5	0.30	2.00	1.10	0.179
	52	22.25	21	18	1.5	1.5	52.3	44.9	6.05	8 600	12 000	—	16.5	28.5	25	43.5	37	48	3	4	1.5	1.5	0.55	1.10	0.60	0.250
	52	22.25	21	18	1.5	1.5	56.5	46.7	6.70	8 400	11 000	2FD	14.4	28.5	27	43.5	43	47	3	4	1.5	1.5	0.30	2.00	1.10	0.244
22	44	15	15	11.5	0.6	0.6	35.4	33.6	4.65	9 100	12 000	3CC	11.0	26.5	27	39.5	38	41	3	3.5	0.6	0.6	0.40	1.51	0.83	0.108
	47	17	17.5	13.5	1	1	40.9	35.9	5.05	8 700	12 000	2CC	11.3	27.5	28	41.5	40	44	4	3.5	1	1	0.33	1.79	0.99	0.138
	50	15.25	14	12	1	1	32.1	25.7	3.50	8 400	11 000	—	13.9	27.5	28	44.5	40	47	2	3	1	1	0.55	1.10	0.60	0.140
	50	15.25	14	12	1	1	36.5	30.9	4.30	8 100	11 000	—	12.2	27.5	30	44.5	41	46	2	3	1	1	0.37	1.60	0.88	0.144
	50	19.25	18	15	1	1	43.8	39.1	5.35	8 400	11 000	—	15.5	27.5	28	44.5	38	47	2	4	1	1	0.55	1.10	0.60	0.170
	50	19.25	18	15	1	1	46.0	41.6	5.85	8 100	11 000	—	14.0	27.5	29	44.5	41	46	2	4	1	1	0.37	1.60	0.88	0.178
	56	17.25	16	13	1.5	1.5	43.0	33.9	4.70	7 700	10 000	—	15.7	30.5	31	47.5	44	52	3	4	1.5	1.5	0.59	1.02	0.56	0.210
	56	17.25	16	14	1.5	1.5	52.2	41.1	5.95	7 500	10 000	—	12.2	30.5	32	47.5	47	51	2	3	1.5	1.5	0.31	1.97	1.08	0.216
	56	22.25	21	17	1.5	1.5	60.4	50.6	7.00	8 000	11 000	—	16.9	30.5	28	47.5	41	52	3	5	1.5	1.5	0.55	1.10	0.60	0.290
	56	22.25	21	18	1.5	1.5	63.3	52.7	7.70	7 600	10 000	—	14.6	30.5	31	47.5	46	51	3	4	1.5	1.5	0.31	1.97	1.08	0.273

[Note] 1) Please consult with JTEKT when using the bearings identified by suffix C. They are medium-tapered types especially designed for special purposes.

Single-row tapered roller bearings
metric series

d 25 ~ (30) mm

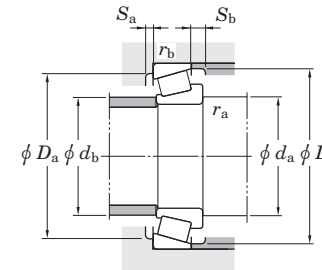
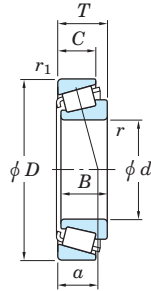

Boundary dimensions (mm)						Basic load ratings (kN)		Fatigue load limit (kN)	Limiting speeds (min ⁻¹)		Bearing No. ¹⁾	Dimension series to ISO355 (Refer.)	Load center (mm) a	Mounting dimensions (mm)								Constant e	Axial load factors		(Refer.) Mass (kg)	
d	D	T	B	C	r min.	r1 min.	Cr	C0r	Cu	Grease lub.				Oil lub.	da min.	db max.	Da max.	Db min.	Sa min.	Sb min.	ra max.		rb max.	Y1		Y0
25	47	15	15	11.5	0.6	0.6	37.8	37.7	5.20	8 300	11 000	4CC	11.8	29.5	30	42.5	40	44	3	3.5	0.6	0.6	0.43	1.39	0.77	0.118
	47	17	17	14	0.6	0.6	42.0	42.3	5.95	8 300	11 000	2CE	10.9	29.5	30	42.5	41	44	3	3	0.6	0.6	0.29	2.07	1.14	0.131
	52	16.25	15	12	1	1	38.0	32.4	4.45	7 900	11 000	—	14.9	30.5	30	46.5	41	49	2	4	1	1	0.58	1.04	0.57	0.155
	52	16.25	15	13	1	1	39.3	33.7	4.75	7 800	10 000	3CC	12.9	30.5	31	46.5	44	48	2	3	1	1	0.37	1.60	0.88	0.156
	52	19.25	18	16	1	1	45.5	43.2	5.90	7 900	11 000	—	16.2	30.5	30	46.5	40	50	2	3	1	1	0.55	1.10	0.60	0.200
	52	19.25	18	16	1	1	49.7	44.8	6.35	7 900	11 000	2CD	13.5	30.5	31	46.5	43	48	2	4	1	1	0.36	1.67	0.92	0.188
	52	22	22	18	1	1	61.1	58.5	8.25	7 900	10 000	2DE	14.1	30.5	30	46.5	43	49	4	4	1	1	0.35	1.71	0.94	0.225
	62	18.25	17	13	1.5	1.5	49.7	42.5	5.80	5 700	8 000	7FB	20.4	33.5	34	53.5	47	58.5	3	5	1.5	1.5	0.83	0.73	0.40	0.269
	62	18.25	17	14	1.5	1.5	56.3	45.8	6.50	6 700	9 000	—	16.3	33.5	35	53.5	50	58	3	4	1.5	1.5	0.55	1.10	0.60	0.275
	62	18.25	17	15	1.5	1.5	60.3	46.9	6.90	6 800	9 000	2FB	12.9	33.5	34	54	54	57	2	3	1.5	1.5	0.30	2.00	1.10	0.273
	62	25.25	24	19	1.5	1.5	71.6	65.8	9.20	7 000	9 300	—	18.9	33.5	33	53.5	46	58	3	6	1.5	1.5	0.55	1.10	0.60	0.390
	62	25.25	24	20	1.5	1.5	76.6	64.1	9.50	6 900	9 100	2FD	16.6	33.5	33	53.5	52	57	3	5	1.5	1.5	0.30	2.00	1.10	0.386
28	52	16	16	12	1	1	44.1	44.0	6.10	7 500	10 000	4CC	12.7	33.5	33	46.5	45	49	3	4	1	1	0.43	1.39	0.77	0.150
	58	17.25	16	13	1	1	48.5	41.7	5.85	7 000	9 300	—	16.0	33.5	34	52.5	47	55	2	4	1	1	0.55	1.10	0.60	0.205
	58	17.25	16	14	1	1	48.5	42.0	6.00	7 000	9 300	—	13.4	33.5	35	52.5	49	54	2	3	1	1	0.37	1.60	0.88	0.209
	58	20.25	19	16	1	1	56.1	54.1	7.50	7 100	9 400	—	17.0	33.5	33	52.5	45	55	3	4	1	1	0.55	1.10	0.60	0.255
	58	20.25	19	16	1	1	61.5	55.2	7.95	6 900	9 100	—	15.0	33.5	35	52.5	49	54.5	2	4	1	1	0.37	1.60	0.88	0.244
	58	24	24	19	1	1	71.9	69.5	10.0	7 000	9 300	2DE	15.4	33.5	34	52.5	49	55	4	5	1	1	0.34	1.77	0.97	0.302
	68	19.75	18	14	1.5	1.5	64.6	50.2	7.25	6 200	8 200	—	17.8	36.5	37	59.5	55	64	3	4.5	1.5	1.5	0.55	1.10	0.60	0.332
	68	19.75	18	16	1.5	1.5	66.9	54.0	8.00	6 100	8 200	—	14.9	36.5	38	59.5	58	63	2	3.5	1.5	1.5	0.32	1.88	1.04	0.345
	68	25.75	24	20	1.5	1.5	83.2	72.9	10.5	6 300	8 500	—	20.5	36.5	35	59.5	51	64	3	5.5	1.5	1.5	0.55	1.10	0.60	0.480
	68	25.75	24	21	1.5	1.5	87.0	75.6	11.3	6 100	8 100	—	17.6	36.5	38	59.5	57	63	3	4.5	1.5	1.5	0.32	1.88	1.04	0.469
30	55	17	17	13	1	1	47.9	48.0	6.75	7 000	9 400	4CC	13.6	35.5	35	49.5	47	52	3	4	1	1	0.43	1.39	0.77	0.177
	55	20	20	16	1	1	54.1	55.2	7.90	7 000	9 400	2CE	13.0	35.5	36	49.5	48	52	3	4	1	1	0.29	2.06	1.13	0.203
	62	17.25	16	13	1	1	52.9	45.1	6.35	6 500	8 700	—	16.5	35.5	36	56.5	51	59	2	4	1	1	0.55	1.10	0.60	0.230
	62	17.25	16	14	1	1	51.8	44.8	6.45	6 500	8 700	3DB	14.1	35.5	37	56.5	53	57	2	3	1	1	0.37	1.60	0.88	0.236
	62	21.25	20	16	1	1	64.6	59.0	8.30	6 600	8 900	—	18.0	35.5	36	56.5	49	59	3	5	1	1	0.55	1.10	0.60	0.300
	62	21.25	20	17	1	1	63.3	57.9	8.40	6 500	8 700	3DC	15.9	35.5	37	56.5	52	58	2	4	1	1	0.37	1.60	0.88	0.292

[Note] 1) Please consult with JTEKT when using the bearings identified by suffix C. They are medium-tapered types especially designed for special purposes.

Single-row tapered roller bearings
metric series

d (30) ~ (35) mm

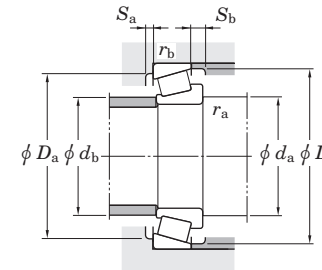
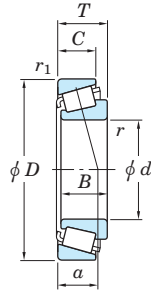

Boundary dimensions (mm)						Basic load ratings (kN)		Fatigue load limit (kN)	Limiting speeds (min ⁻¹)		Bearing No. ¹⁾	Dimension series to ISO355 (Refer.)	Load center (mm) a	Mounting dimensions (mm)								Constant e	Axial load factors		(Refer.) Mass (kg)	
d	D	T	B	C	r _{min.}	r _{1 min.}	C _r	C _{0r}	C _u	Grease lub.				Oil lub.	d _{a min.}	d _{b max.}	D _{a max.}	D _{b min.}	S _{a min.}	S _{b min.}	r _{a max.}		r _{b max.}	Y ₁		Y ₀
30	62	25	25	19.5	1	1	83.1	79.4	11.6	6 500	8 700	2DE	16.3	35.5	36	56.5	53	59	5	5.5	1	1	0.34	1.76	0.97	0.359
	72	20.75	19	14	1.5	1.5	63.5	54.9	7.70	4 900	6 800	7FB	23.7	38.5	40	63.5	55	68	3	6.5	1.5	1.5	0.83	0.73	0.40	0.400
	72	20.75	19	16	1.5	1.5	71.2	55.6	8.10	5 900	7 900	—	18.6	38.5	39	63.5	58	68	3	4.5	1.5	1.5	0.55	1.10	0.60	0.405
	72	20.75	19	16	1.5	1.5	74.4	60.1	9.00	5 800	7 700	2FB	15.7	38.5	40	63.5	62	66	3	4.5	1.5	1.5	0.31	1.90	1.05	0.411
	72	28.75	27	23	1.5	1.5	100	93.8	13.4	6 000	8 000	5FD	22.0	38.5	37	63.5	54	68	3	5.5	1.5	1.5	0.55	1.10	0.60	0.610
	72	28.75	27	23	1.5	1.5	103	91.6	13.8	5 900	7 900	2FD	18.9	38.5	39	63.5	59	66	3	5.5	1.5	1.5	0.31	1.90	1.05	0.588
	72	28.75	27	23	1.5	1.5	103	91.6	13.8	5 900	7 900	32306JR	18.9	38.5	39	63.5	59	66	3	5.5	1.5	1.5	0.31	1.90	1.05	0.588
32	58	17	17	13	1	1	49.2	50.6	7.10	6 700	8 900	4CC	14.3	37.5	38	52.5	50	55	3	4	1	1	0.45	1.32	0.73	0.196
	65	18.25	17	14	1	1	59.3	51.5	7.35	6 200	8 300	—	17.2	37.5	38	59.5	53	62	3	4	1	1	0.55	1.10	0.60	0.275
	65	18.25	17	15	1	1	60.1	51.4	7.45	6 200	8 200	—	14.9	37.5	39	59.5	55	61	3	3	1	1	0.37	1.60	0.88	0.266
	65	22.25	21	17	1	1	69.6	65.1	9.20	6 300	8 400	—	18.7	37.5	37	59.5	51	62	3	5	1	1	0.55	1.10	0.60	0.340
	65	22.25	21	18	1	1	64.5	57.7	8.45	6 200	8 200	—	16.3	37.5	40	59.5	55	61	2	4	1	1	0.37	1.60	0.88	0.330
	65	26	26	20.5	1	1	89.7	86.9	12.8	6 200	8 300	2DE	16.9	37.5	38	59.5	55	62	5	5.5	1	1	0.35	1.73	0.95	0.404
	75	21.75	20	16	1.5	1.5	79.4	66.3	9.70	5 600	7 400	—	19.7	40.5	42	66.5	60	70	3	5.5	1.5	1.5	0.55	1.10	0.60	0.465
	75	21.75	20	18	1.5	1.5	80.5	65.6	9.90	5 500	7 300	—	16.0	40.5	43	66.5	64	70	3	3.5	1.5	1.5	0.32	1.88	1.04	0.461
	75	29.75	28	23	1.5	1.5	93.8	87.1	12.6	5 600	7 400	5FD	23.7	40.5	41	66.5	57	71	3	6.5	1.5	1.5	0.55	1.10	0.60	0.649
	75	29.75	28	25	1.5	1.5	112	101	15.3	5 600	7 400	—	19.6	40.5	42	66.5	63	69	3	4.5	1.5	1.5	0.32	1.88	1.04	0.650
35	55	14	14	11.5	0.6	0.6	32.8	36.5	5.10	6 600	8 800	2BD	10.9	39.5	40	50.5	49	52	2.5	2.5	0.6	0.6	0.29	2.06	1.13	0.120
	62	18	18	14	1	1	57.0	59.4	8.40	6 200	8 200	4CC	15.1	40.5	40	56.5	54	59	4	4	1	1	0.45	1.32	0.73	0.231
	62	21	20	16	1	1	51.3	53.8	7.70	6 200	8 200	—	14.8	40.5	41	56.5	55	59	3	4	1	1	0.33	1.80	0.99	0.250
	62	21	21	17	1	1	64.3	68.0	9.85	6 200	8 200	2CE	14.2	40.5	41	56.5	55	59	3	4	1	1	0.31	1.97	1.08	0.263
	72	18.25	17	15	1.5	1.5	66.1	56.2	8.10	5 700	7 600	—	17.9	43.5	43	63.5	59	68	3	3	1.5	1.5	0.55	1.10	0.60	0.350
	72	18.25	17	15	1.5	1.5	68.8	60.9	8.95	5 600	7 400	3DB	15.3	43.5	44	63.5	62	67	3	3	1.5	1.5	0.37	1.60	0.88	0.344
	72	24.25	23	19	1.5	1.5	86.3	86.6	12.3	5 700	7 600	—	21.1	43.5	42	63.5	56	68	3	5	1.5	1.5	0.58	1.04	0.57	0.465
	72	24.25	23	19	1.5	1.5	86.9	82.4	12.2	5 600	7 500	3DC	18.2	43.5	43	63.5	61	67	3	5	1.5	1.5	0.37	1.60	0.88	0.453
	72	28	28	22	1.5	1.5	110	107	15.8	5 700	7 500	2DE	18.4	43.5	42	63.5	61	68	5	6	1.5	1.5	0.35	1.70	0.93	0.551
	80	22.75	21	15	2	1.5	78.7	69.1	9.85	4 300	6 000	7FB	26.8	45	44	70	66	76.5	3	7.5	2	1.5	0.83	0.73	0.40	0.536
	80	22.75	21	18	2	1.5	87.2	77.8	11.4	5 200	7 000	—	20.5	45	45	70	63	74	3	4.5	2	1.5	0.55	1.10	0.60	0.560
	80	22.75	21	18	2	1.5	95.2	78.9	12.0	5 200	6 900	2FB	16.9	45	45	70	70	74	3	4.5	2	1.5	0.31	1.90	1.05	0.527

[Note] 1) Please consult with JTEKT when using the bearings identified by suffix C. They are medium-tapered types especially designed for special purposes.

Single-row tapered roller bearings
metric series

d (35) ~ (45) mm

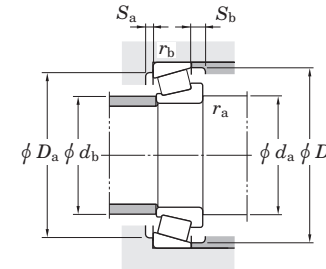
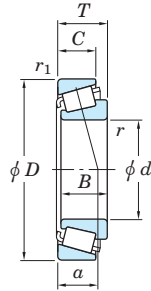

Boundary dimensions (mm)						Basic load ratings (kN)		Fatigue load limit (kN) Cu	Limiting speeds (min ⁻¹)		Bearing No. ¹⁾	Dimension series to ISO355 (Refer.)	Load center (mm) a	Mounting dimensions (mm)								Constant e	Axial load factors		(Refer.) Mass (kg)	
d	D	T	B	C	r min.	r1 min.	Cr		C0r	Grease lub.				Oil lub.	da min.	db max.	Da max.	Db min.	Sa min.	Sb min.	ra max.		rb max.	Y1		Y0
35	80	32.75	31	25	2	1.5	121	123	18.0	5 200	7 000	—	23.8	45	44	70	60	75	3	7.5	2	1.5	0.47	1.27	0.70	0.830
	80	32.75	31	25	2	1.5	126	114	17.3	5 300	7 000			2FE	20.6	45	44	70	66	74	3	7.5	2	1.5	0.31	1.90
40	62	15	15	12	0.6	0.6	42.1	48.5	6.90	5 900	7 800	2BC	11.9	44.5	45	57.5	55	59	3	3	0.6	0.6	0.29	2.07	1.14	0.164
	68	19	19	14.5	1	1	67.2	71.4	10.3	5 600	7 400	3CD	15.1	45.5	46	62.5	60	65	4	4.5	1	1	0.38	1.58	0.87	0.282
	68	22	22	18	1	1	75.9	84.6	12.4	5 500	7 400	2BE	14.7	45.5	46	62.5	60	65	3	4	1	1	0.28	2.12	1.17	0.326
	75	26	26	20.5	1.5	1.5	103	108	16.1	5 200	6 900	2CE	18.3	48.5	47	66.5	65	71	4	5.5	1.5	1.5	0.36	1.69	0.93	0.508
	80	19.75	18	15	1.5	1.5	76.6	67.4	9.90	5 000	6 700	—	20.2	48.5	49	71.5	66	76	3	4.5	1.5	1.5	0.55	1.10	0.60	0.445
	80	19.75	18	16	1.5	1.5	78.4	69.2	10.3	5 000	6 700	3DB	17.0	48.5	49	71.5	69	75	3	3.5	1.5	1.5	0.37	1.60	0.88	0.434
	80	24.75	23	19	1.5	1.5	98.0	93.1	13.7	5 000	6 700	5DC	22.0	48.5	48	71.5	64	76	3	5.5	1.5	1.5	0.55	1.10	0.60	0.570
	80	24.75	23	19	1.5	1.5	97.0	90.8	13.6	5 000	6 600	3DC	19.4	48.5	48	71.5	68	75	3	5.5	1.5	1.5	0.37	1.60	0.88	0.554
	80	32	32	25	1.5	1.5	135	139	20.8	5 000	6 700	2DE	20.7	48.5	47	71.5	67	76	5	7	1.5	1.5	0.36	1.68	0.92	0.758
	85	33	32.5	28	2.5	2	143	143	21.6	4 800	6 400	2EE	21.9	52	48	75	70	80	5	5	2	2	0.34	1.74	0.96	0.900
	90	25.25	23	17	2	1.5	100	90.2	13.1	3 800	5 300	7FB	29.9	50	51	80	71	86.5	3	8	2	1.5	0.83	0.73	0.40	0.757
	90	25.25	23	20	2	1.5	109	98.5	14.8	4 600	6 100	—	23.8	50	53	80	72	84	3	5	2	1.5	0.55	1.10	0.60	0.780
	90	25.25	23	20	2	1.5	113	101	15.5	4 500	6 100	2FB	19.9	50	52	80	77	82	3	5	2	1.5	0.35	1.74	0.96	0.757
	90	35.25	33	26	2	1.5	140	138	20.2	4 700	6 200	—	27.5	50	49	80	67	85	3	9	2	1.5	0.55	1.10	0.60	1.10
	90	35.25	33	27	2	1.5	145	139	21.3	4 600	6 200	2FD	24.3	50	50	80	73	82	3	8	2	1.5	0.35	1.74	0.96	1.06
45	68	15	15	12	0.6	0.6	43.5	52.4	7.45	5 300	7 100	2BC	12.5	49.5	50	63.5	61	64	3	3	0.6	0.6	0.32	1.88	1.04	0.190
	75	20	20	15.5	1	1	78.8	86.5	12.6	5 000	6 600	3CC	16.5	50.5	51	69.5	67	72	4	4.5	1	1	0.39	1.53	0.84	0.354
	75	24	24	19	1	1	87.4	101	14.9	5 000	6 700	2CE	16.4	50.5	51	69.5	67	71	4	5	1	1	0.29	2.04	1.12	0.416
	80	26	26	20.5	1.5	1.5	110	120	17.9	4 800	6 400	3CE	19.4	53.5	52	71.5	69	76.5	4	5.5	1.5	1.5	0.38	1.57	0.86	0.563
	85	20.75	19	15	1.5	1.5	83.1	77.0	11.4	4 600	6 100	—	21.1	53.5	54	76.5	71	80	4	5.5	1.5	1.5	0.55	1.10	0.60	0.500
	85	20.75	19	16	1.5	1.5	83.9	77.4	11.6	4 600	6 100	3DB	18.9	53.5	54	76.5	74	80	3	4.5	1.5	1.5	0.40	1.48	0.81	0.502
	85	24.75	23	19	1.5	1.5	101	102	15.1	4 600	6 200	—	23.0	53.5	53	76.5	69	81	3	5.5	1.5	1.5	0.55	1.10	0.60	0.625
	85	24.75	23	19	1.5	1.5	105	104	15.6	4 600	6 100	3DC	20.3	53.5	53	76.5	73	81	3	5.5	1.5	1.5	0.40	1.48	0.81	0.597
	85	32	32	25	1.5	1.5	139	149	22.3	4 600	6 200	3DE	21.8	53.5	52	76.5	72	81	5	7	1.5	1.5	0.39	1.56	0.86	0.818
	95	29	26.5	20	2.5	2.5	118	118	17.0	3 600	5 100	7FC	32.6	57	54	83	71	91	3	9	2	2	0.87	0.69	0.38	0.943
	95	36	35	30	2.5	2.5	175	177	27.2	4 300	5 700	2ED	23.8	57	55	83	80	89	6	6	2	2	0.32	1.86	1.02	1.20

[Note] 1) Please consult with JTEKT when using the bearings identified by suffix C. They are medium-tapered types especially designed for special purposes.

Single-row tapered roller bearings
metric series

d (45) ~ (55) mm

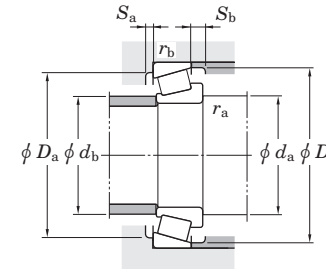
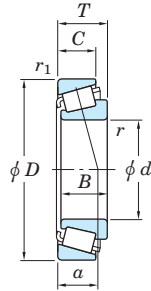

Boundary dimensions (mm)						Basic load ratings (kN)		Fatigue load limit (kN) Cu	Limiting speeds (min ⁻¹)		Bearing No. 1)	Dimension series to ISO355 (Refer.)	Load center (mm) a	Mounting dimensions (mm)								Constant e	Axial load factors		(Refer.) Mass (kg)		
d	D	T	B	C	r min.	r1 min.	Cr		C0r	Grease lub.				Oil lub.	da min.	db max.	Da max.	Db min.	Sa min.	Sb min.	ra max.		rb max.	Y1		Y0	
45	100	27.25	25	18	2	1.5	119	107	15.8	3 400	4 700	30309DJR	7FB	32.9	55	56	90	79	96	3	9	2	1.5	0.83	0.73	0.40	0.973
	100	27.25	25	20	2	1.5	136	119	18.1	4 100	5 500	30309CR	—	25.7	55	57	90	81	94	4	7	2	1.5	0.55	1.10	0.60	1.00
	100	27.25	25	22	2	1.5	141	128	19.9	4 100	5 400	30309JR	2FB	21.3	55	59	90	86	93	3	5	2	1.5	0.35	1.74	0.96	1.01
	100	38.25	36	29	2	1.5	181	182	27.0	4 200	5 600	32309CR	—	30.3	55	56	90	76	95	4	9	2	1.5	0.55	1.10	0.60	1.45
	100	38.25	36	30	2	1.5	183	180	27.7	4 100	5 500	32309JR	2FD	26.8	55	56	90	82	93	3	8	2	1.5	0.35	1.74	0.96	1.43
	50	72	15	15	12	0.6	0.6	45.0	56.3	8.00	4 900	6 600	32910JR	2BC	13.7	54.5	55	67.5	65	69	3	3	0.6	0.6	0.34	1.76	0.97
	80	20	20	15.5	1	1	82.7	94.5	13.8	4 600	6 100	32010JR	3CC	17.7	55.5	56	74.5	72	77	4	4.5	1	1	0.42	1.42	0.78	0.389
	80	24	24	19	1	1	91.8	110	16.3	4 600	6 100	33010JR	2CE	17.4	55.5	56	74.5	72	76	4	5	1	1	0.32	1.90	1.04	0.451
	85	26	26	20	1.5	1.5	112	127	18.9	4 400	5 900	33110JR	3CE	20.6	58.5	56	76.5	74	81.5	4	6	1.5	1.5	0.41	1.46	0.80	0.594
	90	21.75	20	16	1.5	1.5	96.7	95.8	14.3	4 300	5 700	30210CR	—	22.7	58.5	58	81.5	76	86	4	5.5	1.5	1.5	0.55	1.10	0.60	0.590
	90	21.75	20	17	1.5	1.5	95.6	91.7	13.8	4 300	5 700	30210JR	3DB	20.1	58.5	58	81.5	79	85	3	4.5	1.5	1.5	0.42	1.43	0.79	0.566
	90	24.75	23	19	1.5	1.5	106	113	16.7	4 300	5 700	32210CR	—	24.0	58.5	58	81.5	74	86	3	5.5	1.5	1.5	0.55	1.10	0.60	0.675
	90	24.75	23	19	1.5	1.5	106	105	15.9	4 300	5 700	32210JR	3DC	20.6	58.5	58	81.5	78	85	3	5.5	1.5	1.5	0.42	1.43	0.79	0.643
	90	32	32	24.5	1.5	1.5	150	167	25.0	4 300	5 700	33210JR	3DE	23.1	58.5	57	81.5	77	86.5	5	7.5	1.5	1.5	0.41	1.45	0.80	0.887
	100	36	35	30	2.5	2.5	196	196	30.2	4 100	5 400	T2ED050	2ED	24.5	62	58	88	84	94	6	6	2	2	0.34	1.75	0.96	1.28
	105	32	29	22	3	3	141	140	20.3	3 300	4 600	T7FC050	7FC	35.9	64	59	91	78	100	4	10	2.5	2.5	0.87	0.69	0.38	1.25
	110	29.25	27	19	2.5	2	144	133	19.8	3 100	4 300	30310DJR	7FB	35.0	62	62	98	87	105	3	10	2	2	0.83	0.73	0.40	1.25
	110	29.25	27	20	2.5	2	155	143	21.9	3 700	4 900	30310CR	—	27.5	62	64	98	90	103	4	9	2	2	0.55	1.10	0.60	1.25
	110	29.25	27	23	2.5	2	172	152	24.0	3 700	4 900	30310JR	2FB	22.9	62	65	98	95	102	3	6	2	2	0.35	1.74	0.96	1.32
	110	42.25	40	33	2.5	2	214	234	34.6	3 800	5 100	32310CR	5FD	33.4	62	61	98	81	103	4	9	2	2	0.55	1.10	0.60	2.00
	110	42.25	40	33	2.5	2	221	220	34.2	3 700	5 000	32310JR	2FD	29.4	62	62	98	90	102	3	9	2	2	0.35	1.74	0.96	1.89
55	80	17	17	14	1	1	55.8	73.3	10.6	4 400	5 900	32911JR	2BC	14.5	61	61	74	72	76	3	3	1	1	0.31	1.94	1.07	0.285
	90	23	23	17.5	1.5	1.5	106	121	18.2	4 100	5 500	32011JR	3CC	19.8	63.5	63	81.5	81	86	4	5.5	1.5	1.5	0.41	1.48	0.81	0.569
	90	27	27	21	1.5	1.5	121	149	22.6	4 100	5 400	33011JR	2CE	19.3	63.5	63	81.5	81	86	5	6	1.5	1.5	0.31	1.92	1.06	0.672
	95	30	30	23	1.5	1.5	145	161	24.6	4 000	5 300	33111JR	3CE	22.5	63.5	62	86.5	83	91	5	7	1.5	1.5	0.37	1.60	0.88	0.868
	100	22.75	21	17	2	1.5	112	108	16.2	3 900	5 200	30211CR	—	24.3	65	63	90	84	95	4	5.5	2	1.5	0.55	1.10	0.60	0.750
	100	22.75	21	18	2	1.5	118	113	17.3	3 900	5 200	30211JR	3DB	20.7	65	64	90	88	94	4	4.5	2	1.5	0.40	1.48	0.81	0.732
	100	26.75	25	21	2	1.5	134	135	20.4	3 900	5 200	32211CR	—	25.9	65	64	90	83	96	4	5.5	2	1.5	0.55	1.10	0.60	0.875

[Note] 1) Please consult with JTEKT when using the bearings identified by suffix C. They are medium-tapered types especially designed for special purposes.

Single-row tapered roller bearings
metric series

d (55) ~ (65) mm

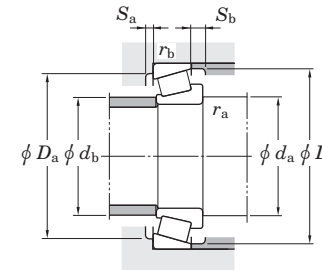
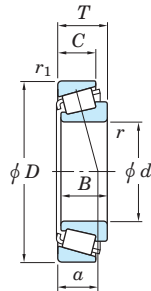

Boundary dimensions (mm)						Basic load ratings (kN)		Fatigue load limit (kN) Cu	Limiting speeds (min ⁻¹)		Bearing No. 1)	Dimension series to ISO355 (Refer.)	Load center (mm) a	Mounting dimensions (mm)								Constant e	Axial load factors		(Refer.) Mass (kg)			
d	D	T	B	C	r min.	r1 min.	Cr		C0r	Grease lub.				Oil lub.	da min.	db max.	Da max.	Db min.	Sa min.	Sb min.	ra max.		rb max.	Y1		Y0		
55	100	26.75	25	21	2	1.5	134	133	20.5	3 900	5 200	32211JR-1	3DC	23.0	65	63	90	87	95	4	5.5	2	1.5	0.40	1.48	0.81	0.863	
	100	35	35	27	2	1.5	178	189	28.9	3 900	5 200	33211JR	3DE	25.3	65	62	90	85	96	6	8	2	1.5	0.40	1.50	0.83	1.18	
	115	34	31	23.5	3	3	161	164	23.9	3 000	4 200	T7FC055	7FC	38.6	69	65	101	86	109	4	10.5	2.5	2.5	0.87	0.69	0.38	1.59	
	120	31.5	29	21	2.5	2	161	148	22.3	2 900	4 000	30311DJR	7FB	38.4	67	68	108	94	113	4	10.5	2	2	0.83	0.73	0.40	1.59	
	120	31.5	29	22	2.5	2	180	161	24.8	3 400	4 500	30311CR	—	29.8	67	70	108	97	112	4.5	9.5	2	2	0.55	1.10	0.60	1.58	
	120	31.5	29	25	2.5	2	187	170	27.0	3 300	4 500	30311JR	2FB	25.5	67	71	108	104	111	4	6.5	2	2	0.35	1.74	0.96	1.65	
	120	45.5	43	35	2.5	2	230	247	36.9	3 400	4 600	32311C	5FD	35.9	67	67	108	90	113	4	10	2	2	0.55	1.10	0.60	2.45	
	120	45.5	43	35	2.5	2	214	203	31.8	3 400	4 500	32311J	2FD	32.4	67	68	108	99	111	4	10.5	2	2	0.35	1.74	0.96	2.24	
	120	45.5	43	35	2.5	2	250	250	39.1	3 400	4 500	32311JR	2FD	32.4	67	68	108	99	111	4	10.5	2	2	0.35	1.74	0.96	2.38	
	60	85	17	17	14	1	1	57.6	78.2	11.3	4 100	5 500	32912JR	2BC	15.6	65.5	66	79.5	77	81	3	3	1	1	0.33	1.81	1.00	0.306
95		23	23	17.5	1.5	1.5	108	127	19.0	3 900	5 200	32012JR	4CC	21.0	68.5	67	86.5	85	91	4	5.5	1.5	1.5	0.43	1.39	0.77	0.621	
95		27	27	21	1.5	1.5	127	162	24.5	3 900	5 200	33012JR	2CE	20.1	68.5	67	86.5	85	90	5	6	1.5	1.5	0.33	1.83	1.01	0.719	
100		30	30	23	1.5	1.5	149	170	25.9	3 700	5 000	33112JR	3CE	23.7	68.5	67	91.5	88	96	5	7	1.5	1.5	0.40	1.51	0.83	0.923	
110		23.75	22	17	2	1.5	127	123	18.8	3 500	4 700	30212CR	—	26.2	70	70	100	93	104	4	6.5	2	1.5	0.55	1.10	0.60	0.930	
110		23.75	22	19	2	1.5	133	127	19.7	3 500	4 700	30212JR	3EB	21.9	70	70	100	96	103	4	4.5	2	1.5	0.40	1.48	0.81	0.945	
110		29.75	28	22	2	1.5	160	164	25.1	3 600	4 700	32212CR	—	28.6	70	68	100	91	105	4	7.5	2	1.5	0.55	1.10	0.60	1.20	
110		29.75	28	24	2	1.5	164	167	25.9	3 500	4 700	32212JR	3EC	25.1	70	69	100	95	104	4	5.5	2	1.5	0.40	1.48	0.81	1.19	
110		38	38	29	2	1.5	217	239	36.6	3 600	4 700	33212JR	3EE	27.2	70	69	100	93	105	6	9	2	1.5	0.40	1.48	0.82	1.57	
115		39	38	31	4	2.5	198	227	34.0	3 400	4 600	T5ED060	5ED	32.4	78	70	103	92	110	5	8	3	2	0.53	1.13	0.62	1.81	
115		40	39	33	2.5	2.5	229	242	37.7	3 400	4 600	T2EE060	2EE	27.6	72	70	103	98	109	6	7	2	2	0.33	1.80	0.99	1.80	
125		37	33.5	26	3	3	191	194	28.8	2 800	3 900	T7FC060	7FC	40.8	74	71	111	94	119	4	11	2.5	2.5	0.82	0.73	0.40	2.03	
130		33.5	31	22	3	2.5	191	179	27.1	2 600	3 700	30312DJR	7FB	40.8	74	73	118	103	124	4	11.5	2.5	2	0.83	0.73	0.40	2.01	
130		33.5	31	23	3	2.5	211	196	30.5	3 100	4 200	30312CR	—	31.9	74	75	118	105	121	5	10.5	2.5	2	0.55	1.10	0.60	1.99	
130		33.5	31	26	3	2.5	217	201	31.9	3 100	4 100	30312JR	2FB	26.9	74	77	118	112	120	4	7.5	2.5	2	0.35	1.74	0.96	2.08	
130		48.5	46	37	3	2.5	286	310	41.4	3 200	4 300	32312CR	5FD	38.3	74	73	118	98	122	5	11	2.5	2	0.55	1.10	0.60	3.15	
130		48.5	46	37	3	2.5	277	275	38.6	3 100	4 200	32312J	2FD	32.3	74	74	118	107	120	4	11.5	2.5	2	0.35	1.74	0.96	2.87	
130		48.5	46	37	3	2.5	306	315	44.1	3 100	4 200	32312JR	2FD	32.3	74	74	118	107	120	4	11.5	2.5	2	0.35	1.74	0.96	2.99	
65		90	17	17	14	1	1	59.2	83.1	12.0	3 900	5 200	32913JR	2BC	16.8	70.5	70	84.5	81	86	3	3	1	1	0.35	1.70	0.93	0.327

[Note] 1) Please consult with JTEKT when using the bearings identified by suffix C. They are medium-tapered types especially designed for special purposes.

Single-row tapered roller bearings
metric series

d (65) ~ (70) mm

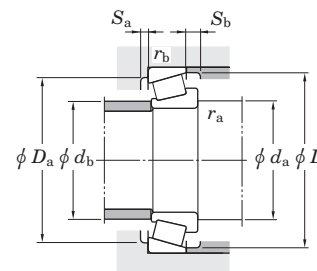
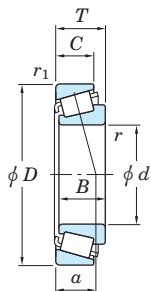

Boundary dimensions (mm)						Basic load ratings (kN)		Fatigue load limit (kN) Cu	Limiting speeds (min ⁻¹)		Bearing No. 1)	Dimension series to ISO355 (Refer.)	Load center (mm) a	Mounting dimensions (mm)								Constant e	Axial load factors		(Refer.) Mass (kg)		
d	D	T	B	C	r _{min.}	r _{1 min.}	Cr		C _{0r}	Grease lub.				Oil lub.	d _{a min.}	d _{b max.}	D _{a max.}	D _{b min.}	S _{a min.}	S _{b min.}	r _{a max.}		r _{b max.}	Y ₁		Y ₀	
65	100	23	23	17.5	1.5	1.5	113	137	20.6	3 600	4 800	32013JR	4CC	22.5	73.5	72	91.5	90	97	4	5.5	1.5	1.5	0.46	1.31	0.72	0.664
	100	27	27	21	1.5	1.5	129	169	25.5	3 600	4 800	33013JR	2CE	21.1	73.5	72	91.5	89	96	5	6	1.5	1.5	0.35	1.72	0.95	0.762
	110	34	34	26.5	1.5	1.5	191	223	34.3	3 400	4 600	33113JR	3DE	25.9	73.5	73	101.5	96	106	6	7.5	1.5	1.5	0.39	1.55	0.85	1.33
	120	24.75	23	18	2	1.5	145	139	21.5	3 200	4 300	30213CR	—	28.1	75	77	110	102	114	4	6.5	2	1.5	0.55	1.10	0.60	1.15
	120	24.75	23	20	2	1.5	160	156	24.3	3 200	4 300	30213JR	3EB	24.2	75	77	110	106	113	4	4.5	2	1.5	0.40	1.48	0.81	1.18
	120	32.75	31	24	2	1.5	190	198	30.4	3 200	4 300	32213CR	—	31.3	75	75	110	99	114	4	8.5	2	1.5	0.55	1.10	0.60	1.55
	120	32.75	31	27	2	1.5	196	203	31.7	3 200	4 300	32213JR	3EC	26.6	75	76	110	104	115	4	5.5	2	1.5	0.40	1.48	0.81	1.58
	120	39	38	31	4	2.5	190	232	34.7	3 200	4 300	T5ED065	5ED	34.1	83	75	108	96	115	5	8	3	2	0.56	1.07	0.59	1.93
	120	41	41	32	2	1.5	250	277	43.0	3 200	4 300	33213JR	3EE	30.0	75	74	110	102	115	7	9	2	1.5	0.39	1.54	0.85	2.02
	130	37	33.5	26	3	3	186	211	31.2	2 600	3 600	T7FC065	7FC	44.4	79	78	116	98	124	4	11	2.5	2.5	0.87	0.69	0.38	2.17
	140	36	33	23	3	2.5	220	209	31.4	2 400	3 400	30313DJR	7GB	44.3	79	79	128	111	133	4	13	2.5	2	0.83	0.73	0.40	2.44
	140	36	33	25	3	2.5	241	227	35.1	2 900	3 900	30313CR	—	34.3	79	81	128	113	130	5	11	2.5	2	0.55	1.10	0.60	2.44
	140	36	33	28	3	2.5	255	239	37.6	2 800	3 800	30313JR	2GB	29.3	79	83	128	122	130	4	8	2.5	2	0.35	1.74	0.96	2.56
	140	51	48	39	3	2.5	322	361	49.0	2 900	3 900	32313CR	5GD	40.9	79	79	128	106	131	5	12	2.5	2	0.55	1.10	0.60	3.85
	140	51	48	39	3	2.5	313	312	43.4	2 900	3 900	32313J	2GD	34.7	79	80	128	117	130	4	12	2.5	2	0.35	1.74	0.96	3.49
	140	51	48	39	3	2.5	346	357	49.6	2 900	3 900	32313JR	2GD	34.7	79	80	128	117	130	4	12	2.5	2	0.35	1.74	0.96	3.64
70	100	20	20	16	1	1	89.0	115	17.2	3 500	4 700	32914JR	2BC	17.8	75.5	77	94.5	91	96	4	4	1	1	0.32	1.90	1.05	0.496
	110	25	25	19	1.5	1.5	136	163	24.8	3 300	4 400	32014JR	4CC	23.6	78.5	78	101.5	98	105	5	6	1.5	1.5	0.43	1.38	0.76	0.884
	110	31	31	25.5	1.5	1.5	168	208	32.3	3 300	4 400	33014JR	2CE	22.1	78.5	78	101.5	99	105	5	5.5	1.5	1.5	0.28	2.11	1.16	1.09
	120	37	37	29	2	1.5	227	266	41.2	3 100	4 200	33114JR	3DE	28.0	80	79	110	104	115	6	8	2	1.5	0.38	1.58	0.87	1.71
	125	26.25	24	19	2	1.5	158	158	24.5	3 000	4 000	30214CR	—	29.9	80	82	116.5	107	119	4	7	2	1.5	0.55	1.10	0.60	1.30
	125	26.25	24	21	2	1.5	173	173	27.1	3 100	4 100	30214JR	3EB	25.9	80	81	116.5	110	118	4	5	2	1.5	0.42	1.43	0.79	1.32
	125	33.25	31	24	2	1.5	197	212	32.6	3 100	4 100	32214CR	—	32.6	80	80	116.5	104	120	4	9.5	2	1.5	0.55	1.10	0.60	1.65
	125	33.25	31	27	2	1.5	212	225	35.2	3 100	4 100	32214JR	3EC	29.2	80	80	116.5	108	119	4	6	2	1.5	0.42	1.43	0.79	1.71
	125	41	41	32	2	1.5	258	294	45.5	3 100	4 100	33214JR	3EE	31.2	80	79	116.5	107	120	7	9	2	1.5	0.41	1.47	0.81	2.16
	130	43	42	35	3	2.5	291	319	50.0	3 000	4 000	T2ED070	2ED	30.2	84	81	118	111	123	1	1	2.5	2	0.33	1.80	0.99	2.48
	140	39	35.5	27	3	3	222	242	35.8	2 400	3 400	T7FC070	7FC	46.5	84	82	126	106	133	5	12	2.5	2.5	0.87	0.69	0.38	2.64
	140	52	51	43	5	3	330	382	51.6	2 900	3 800	T4FE070	4FE	37.7	92	82	126	111	133	7	9	4	2.5	0.45	1.34	0.74	3.69

[Note] 1) Please consult with JTEKT when using the bearings identified by suffix C. They are medium-tapered types especially designed for special purposes.

Single-row tapered roller bearings
metric series

d (70) ~ (80) mm

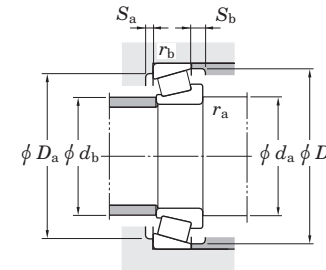
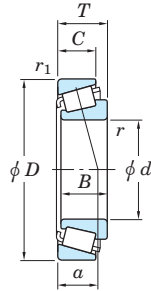

Boundary dimensions (mm)						Basic load ratings (kN)		Fatigue load limit (kN)	Limiting speeds (min ⁻¹)		Bearing No. ¹⁾	Dimension series to ISO355 (Refer.)	Load center (mm) <i>a</i>	Mounting dimensions (mm)								Constant <i>e</i>	Axial load factors		(Refer.) Mass (kg)			
<i>d</i>	<i>D</i>	<i>T</i>	<i>B</i>	<i>C</i>	<i>r</i> _{min.}	<i>r</i> _{1 min.}	<i>C_r</i>	<i>C_{0r}</i>	<i>C_u</i>	Grease lub.				Oil lub.	<i>d_a</i> _{min.}	<i>d_b</i> _{max.}	<i>D_a</i> _{max.}	<i>D_b</i> _{min.}	<i>S_a</i> _{min.}	<i>S_b</i> _{min.}	<i>r_a</i> _{max.}		<i>r_b</i> _{max.}	<i>Y₁</i>		<i>Y₀</i>		
70	150	38	35	25	3	2.5	246	235	34.9	2 300	3 200	30314DJR	7GB	47.1	84	84	138	118	142	4	13	2.5	2	0.83	0.73	0.40	2.97	
	150	38	35	30	3	2.5	280	256	36.0	2 700	3 600	30314CR	—	37.0	84	87	138	123	141	6	8	2.5	2	0.55	1.10	0.60	3.10	
	150	38	35	30	3	2.5	288	273	42.2	2 600	3 500	30314JR	2GB	30.5	84	89	138	130	140	4	8	2.5	2	0.35	1.74	0.96	3.08	
	150	54	51	42	3	2.5	321	315	44.1	2 700	3 600	32314	—	37.0	84	86	138	125	140	4	12	2.5	2	0.35	1.73	0.95	4.11	
	150	54	51	42	3	2.5	371	391	51.4	2 700	3 600	32314C	5GD	44.4	84	84	138	115	142	5	12	2.5	2	0.55	1.10	0.60	4.50	
	150	54	51	42	3	2.5	396	414	57.2	2 700	3 600	32314JR	2GD	37.4	84	86	138	125	140	4	12	2.5	2	0.35	1.74	0.96	4.50	
75	105	20	20	16	1	1	92.2	123	18.4	3 300	4 400	32915JR	2BC	18.9	80.5	81	99.5	96	101	4	4	1	1	0.33	1.80	0.99	0.526	
	115	25	25	19	1.5	1.5	139	169	25.8	3 100	4 200	32015JR	4CC	25.1	83.5	83	106.5	103	110	5	6	1.5	1.5	0.46	1.31	0.72	0.930	
	115	31	31	25.5	1.5	1.5	177	225	35.0	3 200	4 200	33015JR	2CE	22.9	83.5	83	106.5	104	110	6	5.5	1.5	1.5	0.30	2.01	1.11	1.16	
	125	37	37	29	2	1.5	234	280	43.4	3 000	4 000	33115JR	3DE	29.3	85	84	116.5	109	120	6	8	2	1.5	0.40	1.51	0.83	1.84	
	130	27.25	25	20	2	1.5	171	178	27.4	2 900	3 800	30215CR	—	31.0	85	87	121.5	111	124	5	7	2	1.5	0.55	1.10	0.60	1.40	
	130	27.25	25	22	2	1.5	178	181	28.2	2 900	3 900	30215JR	4DB	27.6	85	86	121.5	115	124	4	5	2	1.5	0.44	1.38	0.76	1.42	
	130	33.25	31	24	2	1.5	204	225	34.5	2 900	3 900	32215CR	—	33.7	85	85	121.5	109	125	4	9	2	1.5	0.55	1.10	0.60	1.75	
	130	33.25	31	27	2	1.5	218	234	36.4	2 900	3 900	32215JR	4DC	30.2	85	85	121.5	114	125	4	6	2	1.5	0.44	1.38	0.76	1.77	
	130	41	41	31	2	1.5	266	310	47.7	2 900	3 900	33215JR	3EE	32.5	85	83	121.5	111	125	7	10	2	1.5	0.43	1.40	0.77	2.26	
	150	42	38	29	3	3	240	270	39.0	2 200	3 100	T7FC075	7FC	50.6	89	89	136	114	143	5	13	2.5	2.5	0.87	0.69	0.38	3.24	
	160	40	37	26	3	2.5	266	254	34.2	2 100	2 900	30315DJR	7GB	49.9	89	91	148	127	151	6	14	2.5	2	0.83	0.73	0.40	3.45	
	160	40	37	26	3	2.5	277	266	36.9	2 100	2 900	30315DR	—	48.8	89	91	148	127	151	6	14	2.5	2	0.81	0.74	0.41	3.48	
	160	40	37	31	3	2.5	310	296	42.1	2 500	3 400	30315CR	—	39.2	89	94	148	130	150	6	9	2.5	2	0.55	1.10	0.60	3.80	
	160	40	37	31	3	2.5	325	311	44.9	2 500	3 300	30315JR	2GB	32.5	89	95	148	139	149	4	9	2.5	2	0.35	1.74	0.96	3.65	
	160	40	37	31	3	2.5	313	298	43.3	2 500	3 300	30315R	—	31.9	89	95	148	139	149	4	9	2.5	2	0.35	1.73	0.95	3.52	
	160	58	55	43	3	2.5	447	474	61.4	2 500	3 400	32315CR	—	46.6	89	90	148	125	154	6	15	2.5	2	0.55	1.10	0.60	5.50	
	160	58	55	45	3	2.5	454	481	64.6	2 500	3 300	32315JR	2GD	40.0	89	91	148	133	149	4	13	2.5	2	0.35	1.74	0.96	5.41	
	160	58	55	45	3	2.5	425	444	60.3	2 500	3 300	32315R	—	39.5	89	91	148	133	149	4	13	2.5	2	0.35	1.73	0.95	5.30	
	80	110	20	20	16	1	1	95.1	131	19.5	3 100	4 200	32916JR	2BC	20.1	85.5	86	104.5	101	106	4	4	1	1	0.35	1.71	0.94	0.556
		125	29	29	22	1.5	1.5	185	225	34.6	2 900	3 900	32016JR	3CC	26.7	88.5	89	116.5	112	120	6	7	1.5	1.5	0.42	1.42	0.78	1.32
125		36	36	29.5	1.5	1.5	218	288	44.8	2 900	3 900	33016JR	2CE	25.1	88.5	90	116.5	112	119	6	6.5	1.5	1.5	0.28	2.16	1.19	1.63	
130		37	37	29	2	1.5	240	294	44.9	2 800	3 800	33116JR	3DE	30.5	90	89	121.5	114	126	6	8	2	1.5	0.42	1.44	0.79	1.93	

[Note] 1) Please consult with JTEKT when using the bearings identified by suffix C. They are medium-tapered types especially designed for special purposes.

Single-row tapered roller bearings
metric series

d (80) ~ (90) mm

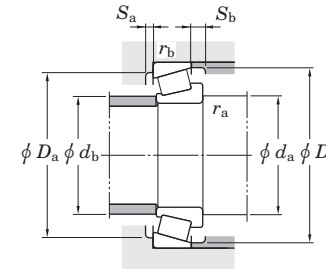
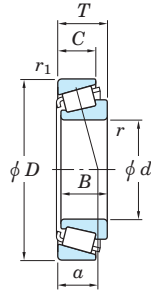

Boundary dimensions (mm)							Basic load ratings (kN)		Fatigue load limit (kN) C_u	Limiting speeds (min ⁻¹)		Bearing No.	Dimension series to ISO355 (Refer.)	Load center (mm) a	Mounting dimensions (mm)								Constant e	Axial load factors		(Refer.) Mass (kg)		
d	D	T	B	C	$r_{min.}$	$r_{1min.}$	C_r	C_{Or}		Grease lub.	Oil lub.				d_a min.	d_b max.	D_a max.	D_b min.	S_a min.	S_b min.	r_a max.	r_b max.		Y_1	Y_0			
80	140	28.25	26	22	2.5	2	202	202	31.2	2 700	3 600	30216JR	3EB	28.6	92	91	130	124	132	4	6	2	2	0.42	1.43	0.79	1.72	
	140	35.25	33	28	2.5	2	253	271	41.5	2 700	3 600	32216JR	3EC	31.7	92	90	130	122	134	4	7	2	2	0.42	1.43	0.79	2.17	
	140	46	46	35	2.5	2	313	371	56.1	2 700	3 600	33216JR	3EE	35.7	92	89	130	119	135	7	11	2	2	0.43	1.41	0.78	2.99	
	145	46	45	38	3	2.5	333	381	52.0	2 600	3 500	T2ED080	2ED	32.7	94	92	133	125	137	7	8	2.5	2	0.32	1.88	1.03	3.20	
	170	42.5	39	27	3	2.5	294	282	38.7	2 000	2 800	30316DJR	7GB	53.5	94	97	158	134	159	6	15.5	2.5	2	0.83	0.73	0.40	4.12	
	170	42.5	39	33	3	2.5	368	355	49.9	2 300	3 100	30316JR	2GB	34.8	94	102	158	148	159	4	9.5	2.5	2	0.35	1.74	0.96	4.46	
	170	42.5	39	33	3	2.5	345	330	47.1	2 300	3 100	30316R	—	33.9	94	102	158	148	159	4	9.5	2.5	2	0.35	1.73	0.95	4.26	
	170	61.5	58	48	3	2.5	434	440	58.6	2 300	3 100	32316J	2GD	43.5	94	98	158	142	159	4	13.5	2.5	2	0.35	1.74	0.96	6.04	
	170	61.5	58	48	3	2.5	480	503	67.0	2 300	3 100	32316JR	2GD	43.5	94	98	158	142	159	4	13.5	2.5	2	0.35	1.74	0.96	6.31	
	85	120	23	23	18	1.5	1.5	122	165	25.0	2 900	3 900	32917JR	2BC	21.2	93.5	93	111.5	109	115	5	5	1.5	1.5	0.33	1.83	1.01	0.794
130		29	29	22	1.5	1.5	189	234	35.5	2 800	3 700	32017JR	4CC	28.0	93.5	94	121.5	117	125	6	7	1.5	1.5	0.44	1.36	0.75	1.38	
130		36	36	29.5	1.5	1.5	222	300	46.0	2 800	3 700	33017JR	2CE	26.3	93.5	94	121.5	118	125	6	6.5	1.5	1.5	0.29	2.06	1.13	1.72	
140		41	41	32	2.5	2	282	346	52.2	2 600	3 500	33117JR	3DE	33.2	97	95	130	122	135	7	9	2	2	0.41	1.48	0.81	2.43	
150		30.5	28	24	2.5	2	228	231	35.1	2 500	3 400	30217JR	3EB	30.4	97	97	140	132	141	5	6.5	2	2	0.42	1.43	0.79	2.17	
150		38.5	36	30	2.5	2	290	315	47.5	2 500	3 400	32217JR	3EC	34.2	97	96	140	130	142	5	8.5	2	2	0.42	1.43	0.79	2.80	
150		49	49	37	2.5	2	368	439	59.1	2 500	3 400	33217JR	3EE	37.1	97	95	140	128	144	7	12	2	2	0.42	1.43	0.79	3.63	
180		44.5	41	28	4	3	288	265	36.0	1 900	2 600	30317D	—	56.0	103	103	166	143	169	6	16.5	3	2.5	0.81	0.74	0.41	4.54	
180		44.5	41	28	4	3	328	317	42.6	1 900	2 600	30317DJR	7GB	56.3	103	103	166	143	169	6	16.5	3	2.5	0.83	0.73	0.40	4.81	
180		44.5	41	34	4	3	396	384	53.0	2 200	2 900	30317JR	2GB	36.0	103	107	166	156	167	5	10.5	3	2.5	0.35	1.74	0.96	5.15	
180		44.5	41	34	4	3	381	367	51.1	2 200	2 900	30317R	—	35.8	103	107	166	156	167	5	10.5	3	2.5	0.35	1.73	0.95	4.97	
180		63.5	60	49	4	3	549	587	77.6	2 200	3 000	32317JR	2GD	43.8	103	103	166	150	167	5	14.5	3	2.5	0.35	1.74	0.96	7.42	
90		125	23	23	18	1.5	1.5	126	175	26.2	2 800	3 700	32918JR	2BC	22.3	98.5	97	116.5	114	120	5	5	1.5	1.5	0.34	1.75	0.96	0.834
		140	32	32	24	2	1.5	224	276	41.5	2 600	3 500	32018JR	3CC	29.8	100	100	131.5	125	134	6	8	2	1.5	0.42	1.42	0.78	1.80
	140	39	39	32.5	2	1.5	278	367	55.6	2 600	3 400	33018JR	2CE	27.1	100	100	131.5	127	135	7	6.5	2	1.5	0.27	2.23	1.23	2.22	
	150	45	45	35	2.5	2	324	413	61.1	2 500	3 300	33118JR	3DE	35.4	102	100	140	130	144	7	10	2	2	0.40	1.51	0.83	3.13	
	155	46	46	38	3	3	342	405	54.1	2 400	3 200	T2ED090	2ED	33.5	104	102	141	135	147	7	8	2.5	2.5	0.33	1.84	1.01	3.47	
	160	32.5	30	26	2.5	2	255	261	39.0	2 400	3 200	30218JR	3FB	32.6	102	103	150	140	150	5	6.5	2	2	0.42	1.43	0.79	2.65	
	160	42.5	40	34	2.5	2	329	362	53.7	2 400	3 200	32218JR	3FC	37.0	102	102	150	138	152	5	8.5	2	2	0.42	1.43	0.79	3.47	

Single-row tapered roller bearings
metric series

d (90) ~ (100) mm

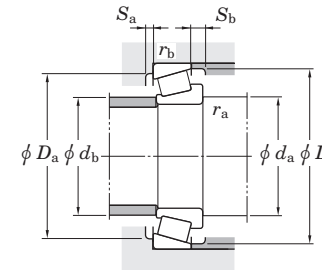
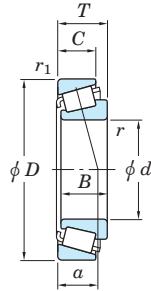

Boundary dimensions (mm)							Basic load ratings (kN)		Fatigue load limit	Limiting speeds (min ⁻¹)		Bearing No.	Dimension series to ISO355 (Refer.)	Load center (mm) <i>a</i>	Mounting dimensions (mm)								Constant <i>e</i>	Axial load factors		(Refer.) Mass (kg)		
<i>d</i>	<i>D</i>	<i>T</i>	<i>B</i>	<i>C</i>	<i>r</i> min.	<i>r</i> ₁ min.	<i>C_r</i>	<i>C</i> _{0r}	(kN) <i>C_u</i>	Grease lub.	Oil lub.				<i>d_a</i> min.	<i>d_b</i> max.	<i>D_a</i> max.	<i>D_b</i> min.	<i>S_a</i> min.	<i>S_b</i> min.	<i>r_a</i> max.	<i>r_b</i> max.		<i>Y</i> ₁	<i>Y</i> ₀			
90	160	55	55	42	2.5	2	430	527	68.3	2 400	3 200	33218JR	3FE	40.8	102	101	150	135	154	9	13	2	2	0.42	1.43	0.78	4.76	
	190	46.5	43	30	4	3	359	350	46.2	1 700	2 400	30318DJR	7GB	59.6	108	109	176	151	179	6	16.5	3	2.5	0.83	0.73	0.40	5.57	
	190	46.5	43	30	4	3	352	336	44.9	1 700	2 400	30318DR	—	59.1	108	109	176	151	179	6	16.5	3	2.5	0.81	0.74	0.41	5.60	
	190	46.5	43	36	4	3	432	420	57.1	2 100	2 700	30318JR	2GB	38.1	108	113	176	165	177	5	10.5	3	2.5	0.35	1.74	0.96	6.04	
	190	46.5	43	36	4	3	421	407	55.5	2 100	2 700	30318R	—	37.2	108	113	176	165	177	5	10.5	3	2.5	0.35	1.73	0.95	5.78	
	190	67.5	64	53	4	3	577	614	78.7	2 100	2 800	32318JR	2GD	46.6	108	108	176	157	177	5	14.5	3	2.5	0.35	1.74	0.96	8.61	
95	130	23	23	18	1.5	1.5	130	186	27.4	2 600	3 500	32919JR	2BC	23.5	103.5	102	121.5	119	125	5	5	1.5	1.5	0.36	1.68	0.92	0.876	
	145	32	32	24	2	1.5	229	287	42.6	2 500	3 300	32019JR	4CC	31.2	105	105	136.5	130	140	6	8	2	1.5	0.44	1.36	0.75	1.88	
	145	39	39	32.5	2	1.5	284	382	57.3	2 500	3 300	33019JR	2CE	27.8	105	104	136.5	131	139	7	6.5	2	1.5	0.28	2.16	1.19	2.31	
	160	46	46	38	3	3	353	427	56.4	2 300	3 100	T2ED095	2ED	34.6	109	107	146	140	152	7	8	2.5	2.5	0.34	1.77	0.97	3.62	
	160	49	49	38	2.5	2	381	473	62.5	2 300	3 100	33119JR	3EE	37.3	107	106	150	138	154	8	11	2	2	0.39	1.54	0.85	3.89	
	170	34.5	32	27	3	2.5	289	299	44.0	2 200	3 000	30219JR	3FB	34.9	109	110	158	149	159	5	7.5	2.5	2	0.42	1.43	0.79	3.20	
	170	45.5	43	37	3	2.5	389	439	64.1	2 200	3 000	32219JR	3FC	38.9	109	108	158	145	161	5	8.5	2.5	2	0.42	1.43	0.79	4.34	
	170	58	58	44	3	2.5	468	582	74.0	2 200	2 900	33219JR	3FE	42.8	109	107	158	144	163	9	14	2.5	2	0.41	1.47	0.81	5.66	
	200	49.5	45	32	4	3	398	391	50.4	1 700	2 300	30319DJR	7GB	62.7	113	113	186	157	187	6	17.5	3	2.5	0.83	0.73	0.40	6.68	
	200	49.5	45	38	4	3	396	368	49.2	2 000	2 600	30319	—	39.8	113	118	186	172	186	5	11.5	3	2.5	0.35	1.73	0.95	6.32	
	200	49.5	45	38	4	3	465	455	60.9	2 000	2 600	30319JR	2GB	40.8	113	118	186	172	186	5	11.5	3	2.5	0.35	1.74	0.96	6.96	
	200	71.5	67	55	4	3	534	544	70.2	2 000	2 600	32319	—	49.1	113	115	186	166	186	5	16.5	3	2.5	0.35	1.73	0.95	9.35	
	200	71.5	67	55	4	3	646	695	89.2	2 000	2 600	32319JR	2GD	49.8	113	115	186	166	186	5	16.5	3	2.5	0.35	1.74	0.96	10.1	
	100	140	25	25	20	1.5	1.5	158	217	32.0	2 400	3 300	32920JR	2CC	24.0	109	108	131	128	135	5	5	1.5	1.5	0.33	1.82	1.00	1.19
		145	24	22.5	17.5	3	3	146	167	24.6	2 400	3 200	T4CB100	4CB	29.9	112	109	133	132	140	4	6.5	2.5	2.5	0.47	1.27	0.70	1.12
150		32	32	24	2	1.5	233	298	43.8	2 400	3 200	32020JR	4CC	32.6	110	109	141	134	144	6	8	2	1.5	0.46	1.31	0.72	1.95	
150		39	39	32.5	2	1.5	290	397	59.0	2 400	3 200	33020JR	2CE	28.6	110	108	141	135	143	7	6.5	2	1.5	0.29	2.09	1.15	2.40	
165		47	46	39	3	3	368	458	59.5	2 200	3 000	T2EE100	2EE	35.1	114	112	151	145	157	7	8	2.5	2.5	0.32	1.88	1.04	3.86	
165		52	52	40	2.5	2	408	523	67.4	2 200	3 000	33120JR	3EE	40.1	112	111	155	142	159	8	12	2	2	0.41	1.48	0.81	4.29	
180		37	34	29	3	2.5	323	338	49.1	2 100	2 800	30220JR	3FB	36.8	114	116	168	157	168	5	8	2.5	2	0.42	1.43	0.79	3.83	
180		49	46	39	3	2.5	435	495	63.9	2 100	2 800	32220JR	3FC	42.1	114	114	168	154	171	5	10	2.5	2	0.42	1.43	0.79	5.21	
180		63	63	48	3	2.5	540	680	85.8	2 100	2 800	33220JR	3FE	45.7	114	112	168	151	172	10	15	2.5	2	0.40	1.48	0.82	6.92	

Single-row tapered roller bearings
metric series

d (100) ~ (110) mm

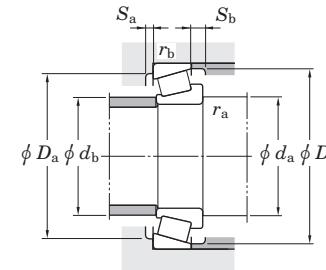
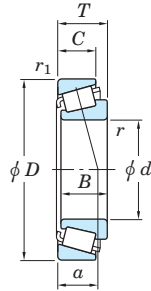

Boundary dimensions (mm)							Basic load ratings (kN)		Fatigue load limit	Limiting speeds (min ⁻¹)		Bearing No.	Dimension series to ISO355 (Refer.)	Load center (mm) a	Mounting dimensions (mm)								Constant e	Axial load factors		(Refer.) Mass (kg)	
d	D	T	B	C	r _{min.}	r _{1 min.}	C _r	C _{0r}	(kN) C _u	Grease lub.	Oil lub.				d _{a min.}	d _{b max.}	D _{a max.}	D _{b min.}	S _{a min.}	S _{b min.}	r _{a max.}	r _{b max.}		Y ₁	Y ₀		
100	215	51.5	47	34	4	3	397	374	48.5	1 500	2 100	30320D	—	65.9	118	121	201	183	204	5	17	3	2.5	0.81	0.74	0.41	8.02
	215	51.5	47	39	4	3	430	400	52.5	1 800	2 400	30320	—	41.4	118	127	201	184	200	6	12.5	3	2.5	0.35	1.73	0.95	7.76
	215	51.5	47	39	4	3	528	521	68.0	1 800	2 400	30320JR	2GB	42.7	118	127	201	184	200	6	12.5	3	2.5	0.35	1.74	0.96	8.49
	215	56.5	51	35	4	3	465	459	56.4	1 500	2 200	31320JR	7GB	67.7	118	120	201	183	202	6	17.5	3	2.5	0.83	0.73	0.40	8.72
	215	77.5	73	60	4	3	614	637	79.6	1 800	2 400	32320	—	52.6	118	123	201	177	200	8	17.5	3	2.5	0.35	1.73	0.95	12.2
	215	77.5	73	60	4	3	725	783	96.9	1 800	2 400	32320JR	2GD	53.9	118	123	201	177	200	8	17.5	3	2.5	0.35	1.74	0.96	13.0
105	145	25	25	20	1.5	1.5	160	224	32.6	2 400	3 100	32921JR	2CC	25.1	113.5	113	136.5	133	140	5	5	1.5	1.5	0.34	1.75	0.96	1.23
	160	35	35	26	2.5	2	270	344	49.9	2 200	3 000	32021JR	4DC	34.5	117	116	150	143	154	6	9	2	2	0.44	1.35	0.74	2.45
	160	43	43	34	2.5	2	335	461	67.4	2 200	3 000	33021JR	2DE	30.9	117	116	150	145	153	7	9	2	2	0.28	2.12	1.17	3.08
	175	56	56	44	2.5	2	453	607	76.0	2 100	2 800	33121JR	3EE	43.2	117	116	165	150	169	9	12	2	2	0.40	1.48	0.82	5.33
	190	39	36	30	3	2.5	360	380	52.3	2 000	2 600	30221JR	3FB	39.0	119	122	178	165	178	6	9	2.5	2	0.42	1.43	0.79	4.49
	190	53	50	43	3	2.5	490	567	73.0	2 000	2 700	32221JR	3FC	44.8	119	120	178	161	180	6	10	2.5	2	0.42	1.43	0.79	6.37
	190	68	68	52	3	2.5	622	790	97.4	2 000	2 600	33221JR	3FE	48.8	119	117	178	159	182	10	16	2.5	2	0.40	1.49	0.82	8.43
	225	53.5	49	36	4	3	423	396	50.1	1 400	2 000	30321D	—	69.1	123	127	211	193	209	6	17	3	2.5	0.81	0.74	0.41	8.76
	225	53.5	49	41	4	3	464	432	56.0	1 700	2 300	30321	—	43.1	123	132	211	193	209	7	12.5	3	2.5	0.35	1.73	0.95	8.74
	225	53.5	49	41	4	3	581	578	73.6	1 700	2 300	30321JR	2GB	44.1	123	132	211	193	209	7	12.5	3	2.5	0.35	1.74	0.96	9.73
	225	58	53	36	4	3	495	489	59.4	1 500	2 100	31321JR	7GB	70.3	123	126	211	193	211	6	18	3	2.5	0.83	0.73	0.40	9.72
	225	81.5	77	63	4	3	679	707	86.7	1 800	2 300	32321	—	55.7	123	128	211	185	209	8	18.5	3	2.5	0.35	1.73	0.95	13.9
	225	81.5	77	63	4	3	794	866	107	1 800	2 300	32321JR	2GD	56.1	123	128	211	185	209	8	18.5	3	2.5	0.35	1.74	0.96	14.9
	110	150	25	25	20	1.5	1.5	162	231	33.3	2 300	3 000	32922JR	2CC	26.3	119	118	141	138	145	5	5	1.5	1.5	0.36	1.69	0.93
160		27	25.5	19.5	3	3	183	225	32.3	2 200	2 900	T4CB110	4CB	31.8	124	120	146	145	154	5	7.5	2.5	2.5	0.44	1.36	0.75	1.63
170		38	38	29	2.5	2	312	395	56.7	2 100	2 800	32022JR	4DC	36.1	122	122	160	152	163	7	9	2	2	0.43	1.39	0.77	3.12
170		47	47	37	2.5	2	360	502	64.9	2 100	2 800	33022JR	2DE	33.4	122	123	160	152	161	7	10	2	2	0.29	2.09	1.15	3.81
180		56	56	43	2.5	2	464	634	78.6	2 000	2 700	33122JR	3EE	44.5	122	121	170	155	174	9	13	2	2	0.42	1.43	0.79	5.52
200		41	38	32	3	2.5	405	434	58.1	1 900	2 500	30222JR	3FB	40.8	124	129	188	174	188	6	9	2.5	2	0.42	1.43	0.79	5.33
200		56	53	46	3	2.5	547	640	80.4	1 900	2 500	32222JR	3FC	46.7	124	126	188	170	190	6	10	2.5	2	0.42	1.43	0.79	7.45
240		54.5	50	36	4	3	456	429	53.5	1 400	1 900	30322D	—	71.5	128	135	226	205	222	6	18	3	2.5	0.81	0.74	0.41	10.2
240		54.5	50	42	4	3	509	475	60.5	1 600	2 100	30322	—	44.8	128	141	226	206	222	8	12.5	3	2.5	0.35	1.73	0.95	10.4

Single-row tapered roller bearings
metric series

d (110) ~ 130 mm

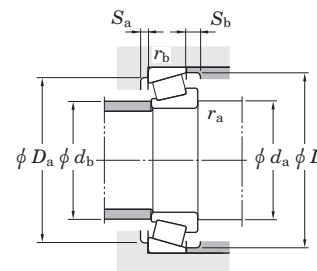
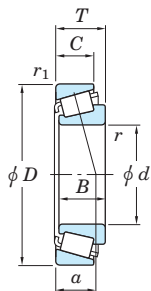

Boundary dimensions (mm)						Basic load ratings (kN)		Fatigue load limit (kN) C_u	Limiting speeds (min^{-1})		Bearing No.	Dimension series to ISO355 (Refer.)	Load center (mm) a	Mounting dimensions (mm)								Constant e	Axial load factors		(Refer.) Mass (kg)		
d	D	T	B	C	r_{\min}	$r_{1\min}$	C_r		C_{0r}	Grease lub.				Oil lub.	d_a min.	d_b max.	D_a max.	D_b min.	S_a min.	S_b min.	r_a max.		r_b max.	Y_1		Y_0	
110	240	54.5	50	42	4	3	601	590	75.2	1 600	2 100	30322JR	2GB	46.3	128	141	226	206	222	8	12.5	3	2.5	0.35	1.74	0.96	11.4
	240	63	57	38	4	3	564	563	68.4	1 400	1 900	31322JR	7GB	76.2	128	135	226	205	224	6	21	3	2.5	0.83	0.73	0.40	12.2
	240	84.5	80	65	4	3	759	797	97.4	1 600	2 200	32322	—	57.3	128	137	226	198	222	9	19.5	3	2.5	0.35	1.73	0.95	16.6
	240	84.5	80	65	4	3	865	943	115	1 600	2 200	32322JR	2GD	59.3	128	137	226	198	222	9	19.5	3	2.5	0.35	1.74	0.96	17.8
120	165	29	29	23	1.5	1.5	215	298	42.5	2 100	2 700	32924JR	2CC	29.4	129	128	156	152	160	6	6	1.5	1.5	0.35	1.72	0.95	1.77
	170	27	25	19.5	3	3	206	262	37.0	2 000	2 700	T4CB120	4CB	34.6	134	130	156	155	164	4	7.5	2.5	2.5	0.47	1.27	0.70	1.76
	180	38	38	29	2.5	2	325	427	60.0	2 000	2 600	32024JR	4DC	38.8	132	131	170	161	173	7	9	2	2	0.46	1.31	0.72	3.34
	180	48	48	38	2.5	2	375	540	68.5	2 000	2 600	33024JR	2DE	36.2	132	132	170	160	171	6	10	2	2	0.31	1.97	1.08	4.16
	200	62	62	48	2.5	2	581	785	96.1	1 800	2 400	33124JR	3FE	47.8	132	133	190	172	192	9	14	2	2	0.40	1.51	0.83	7.73
	215	43.5	40	34	3	2.5	435	473	61.7	1 700	2 300	30224JR	4FB	44.2	134	140	203	187	203	6	9.5	2.5	2	0.44	1.38	0.76	6.36
	215	61.5	58	50	3	2.5	589	691	84.0	1 700	2 300	32224JR	4FD	51.6	134	136	203	181	204	7	11.5	2.5	2	0.44	1.38	0.76	9.04
	260	59.5	55	38	4	3	536	512	61.5	1 200	1 700	30324D	—	77.8	138	145	246	219	239	6	21	3	2.5	0.81	0.74	0.41	13.0
	260	59.5	55	46	4	3	631	611	76.9	1 500	2 000	30324	—	48.9	138	152	246	221	239	10	13.5	3	2.5	0.35	1.73	0.95	13.7
	260	59.5	55	46	4	3	712	714	89.9	1 500	2 000	30324JR	2GB	50.2	138	152	246	221	239	10	13.5	3	2.5	0.35	1.74	0.96	14.5
	260	68	62	42	4	3	657	665	77.8	1 300	1 800	31324JR	7GB	81.9	138	145	246	221	244	6	21	3	2.5	0.83	0.73	0.40	15.4
	260	90.5	86	69	4	3	1 000	1 110	131	1 500	2 000	32324JR	2GD	62.7	138	148	246	213	239	9	21.5	3	2.5	0.35	1.74	0.96	22.2
260	90.5	86	69	4	3	997	1 110	132	1 500	2 000	32324R	—	61.1	138	148	246	213	239	9	21.5	3	2.5	0.35	1.73	0.95	21.8	
130	180	32	32	25	2	1.5	251	368	51.2	1 900	2 500	32926JR	2CC	31.4	140	141	171	165	174	6	7	2	1.5	0.34	1.77	0.97	2.42
	185	29	27	21	3	3	230	282	39.2	1 800	2 500	T4CB130	4CB	37.8	144	141	171	170	179	5	8	2.5	2.5	0.47	1.27	0.70	2.22
	200	45	45	34	2.5	2	428	563	77.4	1 800	2 300	32026JR	4EC	42.9	142	144	190	178	192	8	11	2	2	0.43	1.38	0.76	5.04
	200	55	55	43	2.5	2	489	705	85.8	1 700	2 300	33026JR	2EE	42.5	142	143	190	178	192	8	12	2	2	0.34	1.76	0.97	6.19
	230	43.75	40	34	4	3	472	511	65.7	1 600	2 100	30226JR	4FB	46.2	148	152	216	203	218	7	9.5	3	2.5	0.44	1.38	0.76	7.24
	230	67.75	64	54	4	3	693	830	99.9	1 600	2 200	32226JR	4FD	56.0	148	146	216	193	219	7	13.5	3	2.5	0.44	1.38	0.76	11.5
	280	63.75	58	41	5	4	604	582	69.9	1 200	1 600	30326D	—	84.0	152	155	262	240	261	7	22	4	3	0.81	0.74	0.41	16.3
	280	63.75	58	49	5	4	823	834	102	1 400	1 800	30326JR	2GB	54.0	152	164	262	239	255	8	14.5	4	3	0.35	1.74	0.96	18.1
	280	72	66	44	5	4	734	748	85.7	1 200	1 600	31326JR	7GB	87.3	152	155	262	236	261	7	23	4	3	0.83	0.73	0.40	18.9
	280	98.75	93	78	5	4	1 070	1 160	134	1 400	1 800	32326	—	69.1	152	163	262	226	259	10	15	4	3	0.35	1.73	0.95	26.5

Single-row tapered roller bearings
metric series

d 140 ~ (170) mm

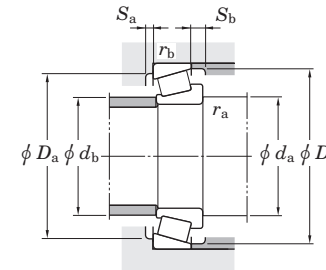
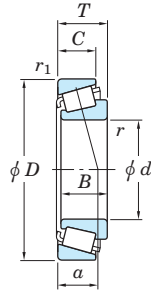

Boundary dimensions (mm)						Basic load ratings (kN)		Fatigue load limit	Limiting speeds (min ⁻¹)		Bearing No.	Dimension series to ISO355 (Refer.)	Load center (mm) a	Mounting dimensions (mm)								Constant e	Axial load factors		(Refer.) Mass (kg)	
d	D	T	B	C	r min.	r1 min.	Cr	C0r	(kN) Cu	Grease lub.				Oil lub.	da min.	db max.	Da max.	Db min.	Sa min.	Sb min.	ra max.		rb max.	Y1		Y0
140	190	32	32	25	2	1.5	258	390	53.2	1 800	2 300	2CC	33.6	150	150	181	174	184	6	7	2	1.5	0.36	1.67	0.92	2.57
	195	29	27	21	3	3	232	293	39.9	1 700	2 300	4CB	40.9	154	151	181	180	189	5	8	2.5	2.5	0.50	1.19	0.66	2.36
	210	45	45	34	2.5	2	435	585	79.2	1 700	2 200	4DC	45.6	152	153	200	187	202	8	11	2	2	0.46	1.31	0.72	5.28
	210	56	56	44	2.5	2	510	758	90.9	1 600	2 200	2DE	45.6	152	152	200	186	202	7	12	2	2	0.36	1.67	0.92	6.61
	250	45.75	42	36	4	3	526	570	71.8	1 500	1 900	4FB	49.4	158	163	236	219	237	9	9.5	3	2.5	0.44	1.38	0.76	8.97
	250	71.75	68	58	4	3	796	961	112	1 500	2 000	4FD	60.0	158	158	236	210	238	9	13.5	3	2.5	0.44	1.38	0.76	14.7
	300	67.75	62	44	5	4	655	627	74.5	1 100	1 500	—	90.2	162	169	282	254	280	7	23	4	3	0.81	0.74	0.41	20.0
	300	67.75	62	53	5	4	938	962	114	1 300	1 700	2GB	56.9	162	179	282	254	273	10	14.5	4	3	0.35	1.74	0.96	22.6
	300	77	70	47	5	4	841	865	99.1	1 100	1 500	7GB	93.8	162	167	282	254	280	8	26	4	3	0.83	0.73	0.40	23.3
	300	107.75	102	85	5	4	1 370	1 570	175	1 300	1 700	—	74.2	162	175	282	246	280	10	17	4	3	0.35	1.74	0.96	35.1
150	210	38	38	30	2.5	2	358	536	72.1	1 600	2 100	2DC	36.1	162	163	200	194	202	7	8	2	2	0.33	1.83	1.01	3.96
	225	48	48	36	3	2.5	492	668	79.6	1 500	2 000	4EC	48.8	164	164	213	200	216	8	12	2.5	2	0.46	1.31	0.72	6.41
	225	59	59	46	3	2.5	575	869	101	1 500	2 000	2EE	47.8	164	164	213	200	217	8	13	2.5	2	0.36	1.65	0.90	8.09
	270	49	45	38	4	3	604	664	80.9	1 300	1 800	4GB	52.4	168	175	256	234	255	9	11	3	2.5	0.44	1.38	0.76	11.6
	270	77	73	60	4	3	881	1 070	122	1 300	1 800	4GD	65.2	168	170	256	226	254	8	17	3	2.5	0.44	1.38	0.76	18.2
	320	72	65	46	5	4	768	750	85.7	970	1 400	—	96.0	172	183	302	270	301	9	26	4	3	0.81	0.74	0.41	23.9
	320	72	65	55	5	4	1 050	1 080	129	1 200	1 500	2GB	60.8	172	193	302	272	292	12	17	4	3	0.35	1.74	0.96	26.6
	320	82	75	50	5	4	952	989	110	980	1 400	7GB	100.1	172	179	302	272	301	9	27	4	3	0.83	0.73	0.40	28.0
	320	114	108	90	5	4	1 550	1 790	195	1 200	1 600	—	78.4	172	187	302	263	298	10	17	4	3	0.35	1.74	0.96	42.0
	160	220	32	30	23	3	3	282	379	50.2	1 500	2 000	4DB	44.7	174	172	206	204	213	5	9	2.5	2.5	0.49	1.23	0.68
220		38	38	30	2.5	2	368	568	75.2	1 500	2 000	2DC	38.4	172	173	210	204	212	7	8	2	2	0.35	1.73	0.95	4.19
240		51	51	38	3	2.5	553	758	90.3	1 400	1 900	4EC	52.1	174	175	228	213	231	8	13	2.5	2	0.46	1.31	0.72	7.75
290		52	48	40	4	3	679	750	89.3	1 200	1 600	4GB	56.3	178	189	276	252	269	8	12	3	2.5	0.44	1.38	0.76	14.1
290		84	80	67	4	3	994	1 210	137	1 200	1 700	4GD	70.3	178	182	276	242	274	10	17	3	2.5	0.44	1.38	0.76	23.2
340		75	68	48	5	4	926	933	104	900	1 300	—	101.8	182	195	322	290	320	9	27	4	3	0.81	0.74	0.41	29.1
340		75	68	58	5	4	1 170	1 220	142	1 100	1 400	2GB	63.3	182	205	322	289	310	12	17	4	3	0.35	1.74	0.96	31.8
340		121	114	95	5	4	1 530	1 720	187	1 100	1 400	—	83.0	182	200	322	277	316	10	18	4	3	0.35	1.73	0.95	47.9
170	230	38	38	30	2.5	2	370	606	78.8	1 400	1 900	3DC	42.0	182	183	220	213	222	7	8	2	2	0.38	1.57	0.86	4.49

Single-row tapered roller bearings
metric series

d (170) ~ 200 mm

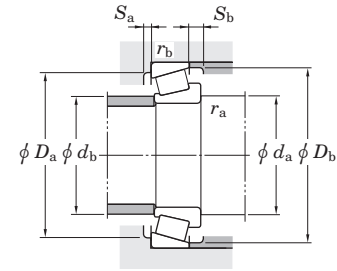
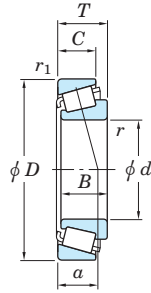

Boundary dimensions (mm)							Basic load ratings (kN)		Fatigue load limit (kN)	Limiting speeds (min ⁻¹)		Bearing No.	Dimension series to ISO355 (Refer.)	Load center (mm) a	Mounting dimensions (mm)								Constant e	Axial load factors		(Refer.) Mass (kg)	
d	D	T	B	C	r _{min.}	r _{1 min.}	C _r	C _{0r}	C _u	Grease lub.	Oil lub.				d _{a min.}	d _{b max.}	D _{a max.}	D _{b min.}	S _{a min.}	S _{b min.}	r _{a max.}	r _{b max.}		Y ₁	Y ₀		
170	260	57	57	43	3	2.5	661	905	105	1 300	1 700	32034JR	4EC	55.8	184	187	248	230	249	10	14	2.5	2	0.44	1.35	0.74	10.5
	310	57	52	43	5	4	776	867	103	1 100	1 500		4GB	61.2	192	202	292	269	288	8	14	4	3	0.44	1.38	0.76	17.8
	310	91	86	71	5	4	1 120	1 380	152	1 100	1 500		4GD	76.2	192	195	292	259	294	10	20	4	3	0.44	1.38	0.76	28.9
	360	80	72	50	5	4	953	1 040	115	830	1 200	30334D	—	108.3	192	211	342	310	333	9	30	4	3	0.81	0.74	0.41	34.3
	360	80	72	62	5	4	1 300	1 370	155	1 000	1 300	30334JR	2GB	67.9	192	218	342	306	329	13	18	4	3	0.35	1.74	0.96	37.5
	360	127	120	100	5	4	1 640	1 830	193	1 000	1 300	32334	—	86.1	192	200	342	295	337	14	26	4	3	0.35	1.73	0.95	56.9
180	250	45	45	34	2.5	2	447	735	93.4	1 300	1 700	32936JR	4DC	53.5	192	193	240	225	241	8	11	2	2	0.48	1.25	0.69	6.64
	280	64	64	48	3	2.5	810	1 100	127	1 200	1 600		3FD	59.5	194	199	268	247	268	10	16	2.5	2	0.42	1.42	0.78	14.1
	320	57	52	43	5	4	771	870	102	1 100	1 400		4GB	63.6	202	211	302	278	297	9	14	4	3	0.45	1.33	0.73	18.3
	320	91	86	71	5	4	1 200	1 520	164	1 100	1 500	32236JR	4GD	77.8	202	204	302	267	303	10	20	4	3	0.45	1.33	0.73	29.9
	380	83	75	52	5	4	1 040	1 150	125	780	1 100	30336D	—	112.8	202	225	362	330	351	10	31	4	3	0.81	0.74	0.41	40.1
	380	83	75	64	5	4	1 130	1 110	126	940	1 300	30336	—	71.0	202	227	362	318	346	13	19	4	3	0.35	1.73	0.95	39.7
	380	134	126	106	5	4	1 760	1 980	206	960	1 300	32336	—	91.8	202	215	362	310	355	14	27	4	3	0.35	1.73	0.95	67.0
190	260	45	45	34	2.5	2	459	789	88.6	1 200	1 600	32938JR	4DC	55.0	202	204	250	235	252	8	11	2	2	0.48	1.26	0.69	6.89
	290	64	64	48	3	2.5	823	1 170	131	1 100	1 500		4FD	62.9	204	209	278	257	279	10	16	2.5	2	0.44	1.36	0.75	14.7
	340	60	55	46	5	4	912	1 030	118	1 000	1 300		4GB	66.4	212	225	322	298	318	12	13	4	3	0.44	1.38	0.76	21.9
	340	97	92	75	5	4	1 370	1 740	187	1 000	1 300	32238JR	4GD	81.9	212	216	322	286	323	12	22	4	3	0.44	1.38	0.76	36.6
	400	86	78	52	6	5	1 190	1 210	131	740	1 000	30338D	—	119.2	218	232	378	350	372	11	34	5	4	0.81	0.74	0.41	44.8
	400	86	78	65	6	5	1 260	1 250	139	880	1 200	30338	—	73.2	218	241	378	342	370	10	20	5	4	0.35	1.73	0.95	46.2
	400	140	132	109	6	5	1 940	2 190	224	890	1 200	32338	—	96.5	218	225	378	330	375	14	30	5	4	0.35	1.73	0.95	76.6
200	280	51	51	39	3	2.5	608	958	109	1 100	1 500	32940JR	3EC	53.6	214	216	268	257	271	9	12	2.5	2	0.39	1.52	0.84	9.44
	310	70	70	53	3	2.5	949	1 340	146	1 100	1 400		4FD	66.9	214	221	298	273	297	11	17	2.5	2	0.43	1.39	0.77	19.1
	360	64	58	48	5	4	991	1 120	126	940	1 200		4GB	70.3	222	238	342	315	336	12	15	4	3	0.44	1.38	0.76	26.4
	360	104	98	82	5	4	1 550	1 880	200	960	1 300	32240JR	3GD	84.6	222	225	342	302	340	11	22	4	3	0.41	1.48	0.81	44.2
	420	89	80	56	6	5	1 130	1 230	132	690	970	30340D	—	122.6	228	248	398	365	385	11	33	5	4	0.81	0.74	0.41	50.6
	420	89	80	67	6	5	1 400	1 450	159	820	1 100	30340	—	79.8	228	255	398	354	385	11	21	5	4	0.35	1.73	0.95	53.5
	420	146	138	115	6	5	2 240	2 580	260	830	1 100	32340	—	102.9	228	240	398	345	395	16	30	5	4	0.35	1.73	0.95	91.0

Single-row tapered roller bearings
metric series

d 220 ~ 360 mm

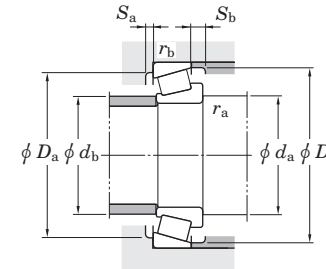
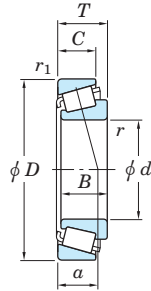

Boundary dimensions (mm)							Basic load ratings (kN)		Fatigue load limit (kN) Cu	Limiting speeds (min ⁻¹)		Bearing No.	Dimension series to ISO355 (Refer.)	Load center (mm) a	Mounting dimensions (mm)								Constant e	Axial load factors		(Refer.) Mass (kg)	
d	D	T	B	C	r _{min.}	r _{1 min.}	Cr	C _{0r}		Grease lub.	Oil lub.				d _{a min.}	d _{b max.}	D _{a max.}	D _{b min.}	S _{a min.}	S _{b min.}	r _{a max.}	r _{b max.}		Y ₁	Y ₀		
220	300	51	51	39	3	2.5	621	1 010	112	1 000	1 400	32944JR	3EC	58.6	234	234	288	275	290	9	12	2.5	2	0.43	1.41	0.78	10.1
	340	76	76	57	4	3	1 120	1 620	175	940	1 300	32044JR	4FD	72.8	238	243	326	300	326	12	19	3	2.5	0.43	1.39	0.77	25.2
	400	72	65	54	5	4	1 260	1 440	160	830	1 100	30244JR	—	76.5	242	263	382	344	371	14	17	4	3	0.44	1.43	0.79	35.9
	400	114	108	90	5	4	1 500	1 930	198	830	1 100	32244	—	95.9	242	260	382	333	377	16	14	4	3	0.43	1.39	0.77	56.8
	460	97	88	73	6	5	1 570	1 680	181	730	980	30344	—	84.6	248	282	438	386	420	12	23	5	4	0.35	1.73	0.95	69.0
240	320	51	51	39	3	2.5	645	1 090	119	940	1 300	32948JR	4EC	64.5	254	254	308	294	311	9	12	2.5	2	0.46	1.31	0.72	10.9
	360	76	76	57	4	3	1 160	1 720	180	870	1 200	32048JR	4FD	78.5	258	261	346	318	346	12	19	3	2.5	0.46	1.31	0.72	26.8
	440	79	72	60	5	4	1 540	1 790	191	730	980	30248R	—	82.7	262	287	422	377	409	14	18	4	3	0.42	1.43	0.79	49.5
	440	127	120	100	5	4	1 920	2 480	245	740	980	32248	—	106.1	262	282	422	365	415	16	14	4	3	0.43	1.39	0.77	76.4
260	360	63.5	63.5	48	3	2.5	926	1 550	163	830	1 100	32952JR	3EC	69.6	274	279	348	328	347	11	15.5	2.5	2	0.41	1.48	0.81	18.9
	400	87	87	65	5	4	1 470	2 170	221	770	1 000	32052JR	4FC	85.0	282	287	382	352	383	14	22	4	3	0.43	1.38	0.76	39.5
	480	89	80	67	6	5	1 510	1 860	190	650	870	30252	—	93.6	288	310	458	415	450	14	21	5	4	0.42	1.44	0.79	64.9
	480	137	130	106	6	5	2 200	2 870	276	660	880	32252	—	115.2	288	300	458	400	455	16	30	5	4	0.43	1.39	0.77	102
280	380	63.5	63.5	48	3	2.5	949	1 630	168	770	1 000	32956JR	4EC	75.1	294	298	368	347	368	11	15.5	2.5	2	0.43	1.39	0.76	20.1
	420	87	87	65	5	4	1 510	2 280	230	720	960	32056JR	4FC	91.1	302	305	402	370	402	14	22	4	3	0.46	1.31	0.72	41.7
	500	89	80	67	6	5	1 580	1 920	196	610	810	30256	—	96.2	308	325	478	440	475	14	21	5	4	0.42	1.44	0.79	67.6
	500	137	130	106	6	5	2 340	3 150	297	610	810	32256	—	117.2	308	325	478	420	474	16	30	5	4	0.43	1.39	0.77	108
300	420	76	76	57	4	3	1 320	2 210	223	680	910	32960JR	3FD	79.9	318	324	406	383	405	12	19	3	2.5	0.39	1.52	0.84	32.4
	460	100	100	74	5	4	1 800	2 660	263	640	850	32060JR	4GD	97.9	322	329	442	404	439	15	26	4	3	0.43	1.38	0.76	57.5
	540	96	85	71	6	5	1 890	2 360	240	550	730	30260	—	103.9	328	350	518	475	505	14	24	5	4	0.42	1.44	0.79	84.7
320	440	76	76	57	4	3	1 330	2 270	226	640	850	32964JR	3FD	85.0	338	342	426	401	426	12	19	3	2.5	0.42	1.44	0.79	34.0
	480	100	100	74	5	4	1 900	2 810	273	600	800	32064JR	4GD	103.0	342	344	462	418	461	16	26	4	3	0.46	1.31	0.72	58.7
	580	104	92	75	6	5	2 190	2 770	273	490	660	30264	—	111.9	348	370	558	505	540	14	28	5	4	0.42	1.44	0.79	108
340	460	76	76	57	4	3	1 340	2 340	229	590	790	32968JR	4FD	90.5	358	361	446	420	446	12	19	3	2.5	0.44	1.37	0.75	35.6
360	480	76	76	57	4	3	1 350	2 400	231	560	740	32972JR	4FD	96.2	378	379	466	438	466	12	19	3	2.5	0.46	1.31	0.72	37.1

Single-row tapered roller bearings
inch series

d 9.525 ~ (22.225) mm

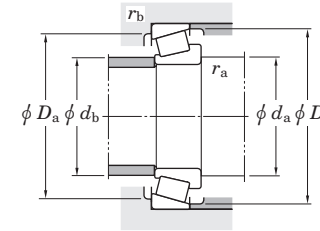
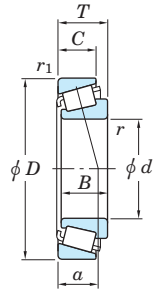

Boundary dimensions (mm)							Basic load ratings (kN)		Fatigue load limit (kN)	Limiting speeds (min ⁻¹)		Bearing No.	Load center (mm)	Mounting dimensions (mm)						Constant e	Axial load factors		(Refer.) Mass (kg)		
d	D	T	B	C	$r_{min.}$	$r1_{min.}$	C_r	C_{0r}	C_u	Grease lub.	Oil lub.			Inner ring	Outer ring	d_a	d_b	D_a	D_b		$r_{a,max.}$	$r_{b,max.}$	Y_1	Y_0	Inner ring
9.525	31.991	10.008	10.785	7.938	1.2	1.2	13.4	9.30	1.25	14 000	19 000	A2037	A2126	7.1	15.0	13.5	26.0	29.0	1.2	1.2	0.40	1.48	0.82	0.029	0.017
11.986	31.991	10.008	10.785	7.938	0.8	1.2	13.4	9.30	1.25	14 000	19 000	A2047	A2126	7.1	16.5	15.5	26.0	29.0	0.8	1.2	0.40	1.48	0.82	0.023	0.017
12.700	34.988	10.998	10.988	8.730	1.2	1.2	15.7	11.9	1.55	12 000	17 000	A4050	A4138	8.3	18.5	17.0	29.0	32.0	1.2	1.2	0.45	1.33	0.73	0.033	0.022
14.989	34.988	10.998	10.988	8.730	0.8	1.2	15.7	11.9	1.55	12 000	17 000	A4059	A4138	8.3	19.5	19.0	29.0	32.0	0.8	1.2	0.45	1.33	0.73	0.029	0.022
15.875	34.988	10.998	10.998	8.712	1.2	1.2	18.1	14.3	1.90	12 000	16 000	L21549	L21511	7.6	21.5	19.5	29.0	32.5	1.2	1.2	0.32	1.88	1.04	0.031	0.018
	41.275	14.288	14.681	11.112	1.2	2.0	27.3	20.5	2.85	11 000	14 000	03062	03162	9.3	21.5	20.0	34.0	37.5	1.2	2.0	0.31	1.93	1.06	0.060	0.035
	42.862	16.670	16.670	13.495	1.6	1.6	38.2	29.5	4.15	10 000	14 000	17580R	17520	10.9	23.0	21.0	36.5	39.0	1.6	1.6	0.33	1.81	1.00	0.078	0.048
	49.225	19.845	21.539	14.288	0.8	1.2	47.2	37.7	5.40	8 900	12 000	09062	09195	10.6	22.0	21.5	42.0	44.5	0.8	1.2	0.27	2.26	1.24	0.139	0.065
	53.975	22.225	21.839	15.875	0.8	2.4	52.6	41.2	5.65	8 400	11 000	21063	21212	16.6	29.0	26.5	43.0	50.0	0.8	2.4	0.59	1.02	0.56	0.163	0.097
16.000	47.000	21.000	21.000	16.000	1.0	2.0	45.4	37.7	5.05	9 800	13 000	HM81649	HM81610	15.0	27.5	23.0	37.5	43.0	1.0	2.0	0.55	1.10	0.60	0.111	0.080
17.462	39.878	13.843	14.605	10.668	1.2	1.2	31.8	26.0	3.60	11 000	14 000	LM11749R	LM11710	8.6	23.0	21.5	34.0	37.0	1.2	1.2	0.29	2.10	1.15	0.058	0.028
19.050	45.237	15.494	16.637	12.065	1.2	1.2	36.8	30.1	4.25	9 400	13 000	LM11949	LM11910	10.0	25.0	23.5	39.5	41.5	1.2	1.2	0.30	2.00	1.10	0.081	0.044
	49.225	19.845	21.539	14.288	1.2	1.2	47.2	37.7	5.40	8 900	12 000	09078	09195	10.6	25.5	24.0	42.0	44.5	1.2	1.2	0.27	2.26	1.24	0.124	0.065
	49.225	21.209	19.050	17.462	1.2	1.6	47.2	37.7	5.40	8 900	12 000	09067	09196	13.8	25.5	24.0	41.5	44.5	1.2	1.6	0.27	2.26	1.24	0.114	0.084
20.000	50.005	13.495	14.260	9.525	1.6	1.0	33.3	28.8	4.05	7 900	11 000	07079	07196	10.8	27.5	26.0	44.5	47.0	1.6	1.0	0.40	1.49	0.82	0.104	0.034
20.638	49.225	19.845	19.845	15.875	1.6	1.6	45.5	37.7	5.35	8 600	12 000	12580	12520	12.7	28.5	26.0	42.5	45.5	1.6	1.6	0.32	1.86	1.02	0.116	0.067
21.430	50.005	17.526	18.288	13.970	1.2	1.2	48.8	40.7	5.80	8 500	11 000	M12649	M12610	11.1	27.5	25.5	44.0	46.0	1.2	1.2	0.28	2.16	1.19	0.119	0.058
21.987	45.974	15.494	16.637	12.065	1.2	1.2	37.5	34.6	4.85	8 900	12 000	LM12749	LM12711	10.0	27.5	26.0	40.0	42.5	1.2	1.2	0.31	1.96	1.08	0.078	0.043
22.225	50.005	17.526	18.288	13.970	1.2	1.2	48.8	40.7	5.80	8 500	11 000	M12648	M12610	11.1	28.5	26.5	44.0	46.0	1.2	1.2	0.28	2.16	1.19	0.115	0.058
	52.388	19.368	20.168	14.288	1.6	1.6	45.9	37.9	5.45	8 000	11 000	1380	1328	11.6	29.5	29.5	45.0	48.5	1.6	1.6	0.29	2.05	1.13	0.132	0.066
	53.975	19.368	20.168	14.288	1.6	1.6	45.9	37.9	5.45	8 000	11 000	1380	1329	11.6	29.5	29.5	46.0	49.0	1.6	1.6	0.29	2.05	1.13	0.137	0.082

[Remark] Inch series tapered roller bearings with bore diameter larger than 100 mm are shown in catalog "large size ball & roller bearings".

Single-row tapered roller bearings
inch series

d (22.225) ~ (26.988) mm

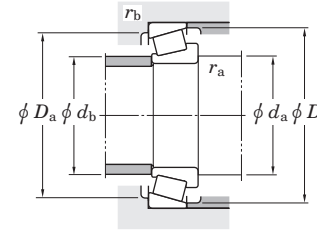
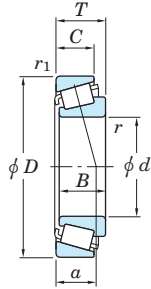

Boundary dimensions (mm)							Basic load ratings (kN)		Fatigue load limit (kN)	Limiting speeds (min ⁻¹)		Bearing No.	Load center (mm)	Mounting dimensions (mm)						Constant e	Axial load factors		(Refer.) Mass (kg)				
d	D	T	B	C	r min.	r_1 min.	C_r	C_{0r}	C_u	Grease lub.	Oil lub.			Inner ring	Outer ring	d_a	d_b	D_a	D_b		r_a max.	r_b max.	Y_1	Y_0	Inner ring	Outer ring	
22.225	56.896	19.368	19.837	15.875	1.2	1.2	50.0	43.1	6.20	7 600	10 000	1755	1729	12.5	29.0	27.5	49.0	51.0	1.2	1.2	0.31	1.95	1.07	0.150	0.100		
	57.150	22.225	22.225	17.462	0.8	1.6	65.8	55.7	8.05	7 600	10 000			1280	1220	15.3	29.5	29.0	49.0	52.0	0.8	1.6	0.35	1.73	0.95	0.189	0.105
	66.421	23.812	25.433	19.050	1.6	1.2	83.8	75.2	11.2	6 500	8 700			2684	2631	13.9	31.5	29.0	58.0	60.0	1.6	1.2	0.25	2.36	1.30	0.295	0.163
22.606	47.000	15.500	15.500	12.000	1.6	1.0	35.0	32.8	4.45	8 700	12 000	LM72849	LM72810	12.3	30.0	28.0	40.5	44.0	1.6	1.0	0.47	1.27	0.70	0.076	0.047		
23.812	50.292	14.224	14.732	10.668	1.6	1.2	39.1	37.0	5.15	7 800	10 000	L44640R	L44610	10.8	30.5	28.5	44.5	47.0	1.6	1.2	0.37	1.60	0.88	0.099	0.034		
	56.896	19.368	19.837	15.875	0.8	1.2	50.0	43.1	6.20	7 600	10 000			1779	1729	12.5	29.5	28.5	49.0	51.0	0.8	1.2	0.31	1.95	1.07	0.141	0.100
24.981	50.005	13.495	14.260	9.525	1.6	1.0	33.3	28.8	4.05	7 900	11 000	07098	07196	10.8	31.0	29.0	44.5	47.0	1.6	1.0	0.40	1.49	0.82	0.084	0.034		
	62.000	16.002	16.566	14.288	1.6	1.6	47.4	40.6	5.80	6 700	8 900			17098	17244	12.7	33.0	30.5	54.0	57.0	1.6	1.6	0.38	1.57	0.86	0.162	0.090
25.000	50.005	13.495	14.260	9.525	1.6	1.0	33.3	28.8	4.05	7 900	11 000	07097	07196	10.8	31.0	29.0	44.5	47.0	1.6	1.0	0.40	1.49	0.82	0.085	0.035		
25.400	50.005	13.495	14.260	9.525	1.0	1.0	33.3	28.8	4.05	7 900	11 000	07100	07196	10.8	30.5	29.5	44.5	47.0	1.0	1.0	0.40	1.49	0.82	0.084	0.035		
	50.005	13.495	14.260	9.525	1.6	1.0	33.3	28.8	4.05	7 900	11 000	07100S	07196	10.8	31.5	29.5	44.5	47.0	1.6	1.0	0.40	1.49	0.82	0.082	0.035		
	50.292	14.224	14.732	10.668	1.2	1.2	39.1	37.0	5.15	7 800	10 000	L44643R	L44610	10.8	31.5	29.5	44.5	47.0	1.2	1.2	0.37	1.60	0.88	0.092	0.039		
	51.994	15.011	14.260	12.700	1.0	1.2	33.3	28.8	4.05	7 900	11 000	07100	07204	12.3	30.5	29.5	45.0	48.0	1.0	1.2	0.40	1.49	0.82	0.075	0.065		
	58.738	19.050	19.355	15.080	1.2	1.2	60.8	57.1	8.25	7 000	9 300	1986R	1932	13.1	32.5	30.5	52.0	54.0	1.2	1.2	0.33	1.82	1.00	0.179	0.088		
	59.530	23.368	23.114	18.288	0.8	1.6	63.0	57.1	7.95	7 200	9 600	M84249	M84210	18.2	36.0	32.5	49.5	56.0	0.8	1.6	0.55	1.10	0.60	0.194	0.128		
	61.912	19.050	20.638	14.288	0.8	2.0	55.7	50.7	7.30	6 400	8 600	15101	15243	13.2	32.5	31.5	55.0	58.0	0.8	2.0	0.35	1.71	0.94	0.215	0.080		
	62.000	19.050	20.638	14.288	3.6	1.2	55.7	50.7	7.30	6 400	8 600	15100	15245	13.2	38.0	31.5	55.0	58.0	3.6	1.2	0.35	1.71	0.94	0.215	0.081		
	63.500	19.050	20.638	14.288	0.8	1.2	55.7	50.7	7.30	6 400	8 600	15101	15250R	13.2	32.5	31.5	55.0	59.0	0.8	1.2	0.35	1.71	0.94	0.215	0.097		
	64.292	21.432	21.432	16.670	1.6	1.6	69.1	70.7	9.90	6 400	8 500	M86643R	M86610	18.0	38.0	36.5	54.0	61.0	1.6	1.6	0.55	1.10	0.60	0.248	0.127		
	66.421	23.812	25.433	19.050	1.2	1.2	83.8	75.2	11.2	6 500	8 700	2687	2631	13.9	33.5	31.5	58.0	60.0	1.2	1.2	0.25	2.36	1.30	0.272	0.163		
	68.262	22.225	22.225	17.462	0.8	1.6	63.7	61.1	8.80	6 000	8 000	02473	02420	17.1	34.5	33.5	59.0	63.0	0.8	1.6	0.42	1.44	0.79	0.275	0.150		
	72.233	25.400	25.400	19.842	0.8	2.4	83.8	87.4	12.4	5 700	7 600	HM88630	HM88610	20.7	39.5	39.5	60.0	69.0	0.8	2.4	0.55	1.10	0.60	0.391	0.185		
	26.162	66.421	23.812	25.433	19.050	1.6	1.2	83.8	75.2	11.2	6 500	8 700	2682	2631	13.9	34.5	32.0	58.0	60.0	1.6	1.2	0.25	2.36	1.30	0.268	0.163	
26.988	50.292	14.224	14.732	10.668	3.6	1.2	39.1	37.0	5.15	7 800	10 000	L44649R	L44610	10.8	37.5	31.0	44.5	47.0	3.6	1.2	0.37	1.60	0.88	0.083	0.039		

[Remark] Inch series tapered roller bearings with bore diameter larger than 100 mm are shown in catalog "large size ball & roller bearings".

Single-row tapered roller bearings
inch series

d (26.988) ~ (30.162) mm

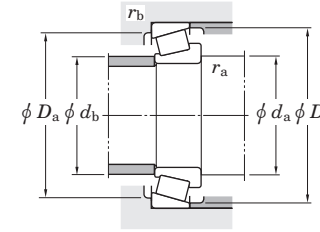
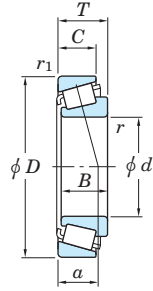

Boundary dimensions (mm)							Basic load ratings (kN)		Fatigue load limit	Limiting speeds (min ⁻¹)		Bearing No.	Load center (mm)	Mounting dimensions (mm)						Constant	Axial load factors		(Refer.) Mass (kg)				
d	D	T	B	C	$r_{min.}$	$r1_{min.}$	C_r	C_{0r}	(kN) C_u	Grease lub.	Oil lub.			Inner ring	Outer ring	d_a	d_b	D_a	D_b		$r_{a,max.}$	$r_{b,max.}$	e	Y_1	Y_0	Inner ring	Outer ring
26.988	60.325	19.842	17.462	15.875	3.6	1.6	47.2	42.7	6.10	7 000	9 400	15580	15523	15.1	38.5	32.0	51.0	54.0	3.6	1.6	0.35	1.73	0.95	0.140	0.122		
	62.000	19.050	20.638	14.288	0.8	1.2	55.7	50.7	7.30	6 400	8 600			15106	15245	13.2	33.5	33.0	55.0	58.0	0.8	1.2	0.35	1.71	0.94	0.206	0.081
	66.421	23.812	25.433	19.050	1.6	1.2	83.8	75.2	11.2	6 500	8 700			2688	2631	13.9	35.0	33.0	58.0	60.0	1.6	1.2	0.25	2.36	1.30	0.262	0.163
28.575	57.150	17.462	17.462	13.495	3.6	1.6	47.2	42.7	6.10	7 000	9 400	15590	15520	12.7	39.0	33.5	51.0	53.0	3.6	1.6	0.35	1.73	0.95	0.131	0.069		
	57.150	19.845	19.355	15.875	3.6	1.6	60.8	57.1	8.25	7 000	9 300			1988R	1922	13.9	39.5	33.5	51.0	53.5	3.6	1.6	0.33	1.82	1.00	0.151	0.076
	62.000	19.050	20.638	14.288	3.6	1.2	55.7	50.7	7.30	6 400	8 600			15112	15245	13.2	40.0	34.0	55.0	58.0	3.6	1.2	0.35	1.71	0.94	0.193	0.081
	62.000	19.050	20.638	14.288	0.8	1.2	55.7	50.7	7.30	6 400	8 600			15113	15245	13.2	34.5	34.0	55.0	58.0	0.8	1.2	0.35	1.71	0.94	0.195	0.081
	64.292	21.432	21.432	16.670	1.6	1.6	69.1	70.7	9.90	6 400	8 500			M86647R	M86610	18.0	40.0	38.0	54.0	61.0	1.6	1.6	0.55	1.10	0.60	0.225	0.127
	66.421	23.812	25.433	19.050	1.2	1.2	83.8	75.2	11.2	6 500	8 700			2689	2631	13.9	36.0	34.0	58.0	60.0	1.2	1.2	0.25	2.36	1.30	0.249	0.165
	68.262	22.225	22.225	17.462	0.8	1.6	63.7	61.1	8.80	6 000	8 000			02474	02420	17.1	36.5	36.0	59.0	63.0	0.8	1.6	0.42	1.44	0.79	0.252	0.150
	72.000	19.000	18.923	15.875	1.6	1.6	59.4	49.6	7.25	5 900	7 800			26112	26283	15.3	37.0	35.0	62.0	65.0	1.6	1.6	0.36	1.67	0.92	0.217	0.163
	72.626	24.608	24.257	17.462	4.8	1.6	77.3	60.5	8.75	6 100	8 100			41125	41286	20.7	48.0	36.5	61.0	68.0	4.8	1.6	0.60	1.00	0.55	0.292	0.177
	72.626	24.608	24.257	17.462	1.6	1.6	77.3	60.5	8.75	6 100	8 100			41126	41286	20.7	41.5	36.5	61.0	68.0	1.6	1.6	0.60	1.00	0.55	0.295	0.177
	72.626	30.162	29.997	23.812	3.6	3.2	98.6	89.3	13.3	5 800	7 700			3192	3120	20.3	42.5	37.0	61.0	67.0	3.6	3.2	0.33	1.80	0.99	0.401	0.222
	72.626	30.162	29.997	23.812	1.2	3.2	98.6	89.3	13.3	5 800	7 700			3198	3120	20.3	39.0	37.0	61.0	67.0	1.2	3.2	0.33	1.80	0.99	0.410	0.222
	73.025	22.225	22.225	17.462	0.8	3.2	68.8	65.7	9.55	5 500	7 400			02872	02820	18.4	37.5	37.0	62.0	68.0	0.8	3.2	0.45	1.32	0.73	0.319	0.158
29.000	50.292	14.224	14.732	10.668	3.6	1.2	36.3	37.2	5.15	7 600	10 000	L45449	L45410	10.9	39.5	33.0	44.5	48.0	3.6	1.2	0.37	1.62	0.89	0.079	0.036		
29.367	66.421	23.812	25.433	19.050	3.6	1.2	83.8	75.2	11.2	6 500	8 700	2690	2631	13.9	41.0	35.0	58.0	60.0	3.6	1.2	0.25	2.36	1.30	0.242	0.165		
29.987	62.000	16.002	16.566	14.288	1.6	1.6	47.4	40.6	5.80	6 700	8 900	17118	17244	12.7	37.0	34.5	54.0	57.0	1.6	1.6	0.38	1.57	0.86	0.135	0.090		
	62.000	19.050	20.638	14.288	1.2	1.2	55.7	50.7	7.30	6 400	8 600			15117	15245	13.2	36.5	35.0	55.0	58.0	1.2	1.2	0.35	1.71	0.94	0.184	0.081
30.000	69.012	19.845	19.583	15.875	3.6	1.2	57.7	55.0	7.95	5 900	7 800	14117A	14276	15.5	42.5	39.5	60.0	63.0	3.6	1.2	0.38	1.57	0.86	0.225	0.135		
30.112	62.000	19.050	20.638	14.288	0.8	1.2	55.7	50.7	7.30	6 400	8 600	15116	15245	13.2	36.0	35.5	55.0	58.0	0.8	1.2	0.35	1.71	0.94	0.184	0.081		
30.162	62.000	16.002	16.566	14.288	1.6	1.6	47.4	40.6	5.80	6 700	8 900	17119	17244	12.7	37.0	34.5	54.0	57.0	1.6	1.6	0.38	1.57	0.86	0.139	0.091		
	64.292	21.432	21.432	16.670	1.6	1.6	69.1	70.7	9.90	6 400	8 500			M86649R	M86610	18.0	41.0	38.0	54.0	61.0	1.6	1.6	0.55	1.10	0.60	0.213	0.127

[Remark] Inch series tapered roller bearings with bore diameter larger than 100 mm are shown in catalog "large size ball & roller bearings".

Single-row tapered roller bearings
inch series

d (30.162) ~ (34.925) mm

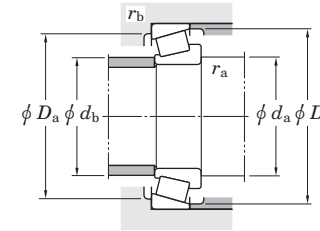
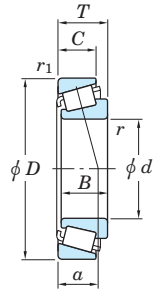

Boundary dimensions (mm)							Basic load ratings (kN)		Fatigue load limit	Limiting speeds (min ⁻¹)		Bearing No.	Load center (mm)	Mounting dimensions (mm)						Constant e	Axial load factors		(Refer.) Mass (kg)		
d	D	T	B	C	$r_1^{(1)}$ min.	r_1 min.	C_r	C_{0r}	(kN) C_u	Grease lub.	Oil lub.			Inner ring	Outer ring	d_a	d_b	D_a	D_b		r_a max.	r_b max.	e	Y_1	Y_0
30.162	68.262	22.225	22.225	17.462	2.4	1.6	70.2	71.1	10.0	6 000	7 900	M88043	M88010	19.2	43.5	39.5	58.0	65.0	2.4	1.6	0.55	1.10	0.60	0.258	0.144
30.213	62.000	19.050	20.638	14.288	3.6	1.2	55.7	50.7	7.30	6 400	8 600	15118	15245	13.2	41.5	35.5	55.0	58.0	3.6	1.2	0.35	1.71	0.94	0.181	0.081
	62.000	19.050	20.638	14.288	1.6	1.2	55.7	50.7	7.30	6 400	8 600	15119	15245	13.2	37.5	35.5	55.0	58.0	1.6	1.2	0.35	1.71	0.94	0.183	0.081
	62.000	19.050	20.638	14.288	0.8	1.2	55.7	50.7	7.30	6 400	8 600	15120	15245	13.2	36.0	35.5	55.0	58.0	0.8	1.2	0.35	1.71	0.94	0.183	0.081
30.226	69.012	19.845	19.583	15.875	0.8	3.2	57.7	55.0	7.95	5 900	7 800	14116	14274	15.5	37.0	36.5	59.0	63.0	0.8	3.2	0.38	1.57	0.86	0.226	0.131
31.750	58.738	14.684	15.080	10.716	1.0	1.0	37.0	33.3	4.60	6 600	8 900	08125	08231	13.5	37.5	36.0	52.0	55.0	1.0	1.0	0.48	1.26	0.69	0.109	0.056
	59.131	15.875	16.764	11.811	SP	1.2	44.8	43.1	6.05	6 600	8 800	LM67048	LM67010	13.0	42.5	36.0	52.0	56.0	3.5	1.2	0.41	1.46	0.80	0.120	0.062
	62.000	18.161	19.050	14.288	SP	1.2	55.7	50.7	7.30	6 400	8 600	15123	15245	13.2	42.5	36.5	55.0	58.0	3.5	1.2	0.35	1.71	0.94	0.157	0.081
	62.000	19.050	20.638	14.288	3.6	1.2	55.7	50.7	7.30	6 400	8 600	15125	15245	13.2	42.5	36.5	55.0	58.0	3.6	1.2	0.35	1.71	0.94	0.169	0.081
	62.000	19.050	20.638	14.288	0.8	1.2	55.7	50.7	7.30	6 400	8 600	15126	15245	13.2	37.0	36.5	55.0	58.0	0.8	1.2	0.35	1.71	0.94	0.171	0.081
	66.421	25.400	25.357	20.638	0.8	3.2	89.2	85.1	12.7	6 000	8 000	2580	2520	16.0	38.5	37.5	57.0	62.5	0.8	3.2	0.27	2.19	1.21	0.281	0.123
	68.262	22.225	22.225	17.462	3.6	1.6	63.7	61.1	8.80	6 000	8 000	02475	02420	17.1	44.5	38.5	59.0	63.0	3.6	1.6	0.42	1.44	0.79	0.224	0.150
	68.262	22.225	22.225	17.462	0.8	1.6	63.7	61.1	8.80	6 000	8 000	02476	02420	17.1	39.0	38.5	59.0	63.0	0.8	1.6	0.42	1.44	0.79	0.226	0.150
	68.262	22.225	22.225	17.462	1.6	1.6	70.2	71.1	10.0	6 000	7 900	M88046	M88010	19.2	43.0	40.5	58.0	65.0	1.6	1.6	0.55	1.10	0.60	0.245	0.144
	73.025	22.225	22.225	17.462	3.6	3.2	68.8	65.7	9.55	5 600	7 400	02875	02820	17.1	45.5	39.5	62.0	68.0	3.6	3.2	0.45	1.32	0.73	0.293	0.158
	73.025	22.225	22.225	17.462	0.8	3.2	68.8	65.7	9.55	5 500	7 400	02876	02820	17.1	40.0	39.5	62.0	68.0	0.8	3.2	0.45	1.32	0.73	0.293	0.158
	73.025	29.370	27.783	23.020	1.2	3.2	93.0	101	14.2	5 600	7 500	HM88542	HM88510	23.4	45.5	42.5	59.0	70.0	1.2	3.2	0.55	1.10	0.60	0.377	0.238
	73.812	29.370	27.783	23.020	1.2	3.2	93.0	101	14.2	5 600	7 500	HM88542	HM88512	23.4	45.5	42.5	59.0	70.0	1.2	3.2	0.55	1.10	0.60	0.377	0.254
33.338	68.262	22.225	22.225	17.462	0.8	1.6	70.2	71.1	10.0	6 000	7 900	M88048	M88010	19.2	42.5	41.0	58.0	65.0	0.8	1.6	0.55	1.10	0.60	0.231	0.144
	72.000	19.000	18.923	15.875	3.6	1.6	69.8	60.0	8.85	5 900	7 800	26131	26283	14.3	44.5	38.5	62.0	65.0	3.6	1.6	0.36	1.67	0.92	0.200	0.163
	73.025	29.370	27.783	23.020	0.8	3.2	93.0	101	14.2	5 600	7 500	HM88547	HM88510	23.4	45.5	42.6	59.0	70.0	0.8	3.2	0.55	1.10	0.60	0.360	0.238
	76.200	29.370	28.575	23.020	0.8	3.2	99.5	107	15.2	5 400	7 200	HM89443	HM89410	23.9	46.5	44.6	62.0	73.0	0.8	3.2	0.55	1.10	0.60	0.415	0.254
34.925	65.088	18.034	18.288	13.970	SP	1.2	60.0	58.5	8.40	6 000	8 000	LM48548	LM48510	14.3	46.0	40.0	58.0	61.0	3.5	1.2	0.38	1.59	0.88	0.164	0.086
	69.012	26.982	26.721	15.875	0.8	1.2	57.7	55.0	7.95	5 900	7 800	14136A	14276	22.6	40.0	38.0	60.0	63.0	0.8	1.2	0.38	1.57	0.86	0.254	0.133
	72.233	25.400	25.400	19.842	2.4	2.4	83.8	87.4	12.4	5 700	7 600	HM88649	HM88610	20.7	48.5	42.5	60.0	69.0	2.4	2.4	0.55	1.10	0.60	0.301	0.185

[Note] 1) SP indicates the specially chamfered from.

[Remark] Inch series tapered roller bearings with bore diameter larger than 100 mm are shown in catalog "large size ball & roller bearings".

Single-row tapered roller bearings
inch series

d (34.925) ~ (38.100) mm

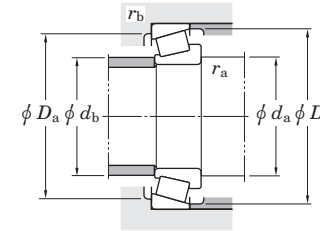
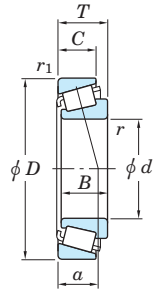

Boundary dimensions (mm)							Basic load ratings (kN)		Fatigue load limit (kN)	Limiting speeds (min ⁻¹)		Bearing No. ²⁾	Load center (mm)	Mounting dimensions (mm)						Constant e	Axial load factors		(Refer.) Mass (kg)		
d	D	T	B	C	$r_1^{1)}$ min.	$r_1^{1)}$ min.	C_r	C_{0r}	C_u	Grease lub.	Oil lub.			Inner ring	Outer ring	a	d_a	d_b	D_a		D_b	r_a max.	r_b max.	e	Y_1
34.925	72.238	20.638	20.638	15.875	3.6	1.2	62.3	61.3	8.90	5 600	7 400	16137	16284	16.6	46.5	40.5	63.0	67.0	3.6	1.2	0.40	1.49	0.82	0.236	0.144
	73.025	22.225	22.225	17.462	3.6	3.2	68.8	65.7	9.55	5 500	7 400	02877	02820	18.4	48.5	42.0	62.0	68.0	3.6	3.2	0.45	1.32	0.73	0.262	0.158
	73.025	22.225	22.225	17.462	0.8	3.2	68.8	65.7	9.55	5 500	7 400	02878	02820	18.4	42.5	42.0	62.0	68.0	0.8	3.2	0.45	1.32	0.73	0.265	0.158
	73.025	23.812	24.608	19.050	1.6	0.8	90.1	87.3	13.1	5 600	7 400	25877R	25821	15.8	43.0	40.5	65.0	68.0	1.6	0.8	0.29	2.07	1.14	0.310	0.165
	73.025	26.988	26.975	22.225	3.6	1.6	97.2	94.1	13.9	5 700	7 600	23690	23620	18.8	49.0	42.0	64.0	68.0	3.6	1.6	0.37	1.62	0.89	0.326	0.212
	76.200	20.638	20.940	15.507	1.6	1.2	71.6	65.9	9.70	5 300	7 000	28137	28300	16.5	43.5	41.0	68.0	71.0	1.6	1.2	0.40	1.49	0.82	0.315	0.137
	76.200	23.812	25.654	19.050	3.6	3.2	92.6	92.2	13.8	5 400	7 200	2796R	2720	15.9	47.5	41.0	66.0	70.0	3.6	3.2	0.30	1.98	1.09	0.344	0.185
	76.200	29.370	28.575	23.812	1.6	3.2	101	97.4	14.4	5 400	7 200	31594	31520	21.6	46.0	43.5	64.0	72.0	1.6	3.2	0.40	1.49	0.82	0.388	0.232
	79.375	29.370	29.771	23.812	3.6	3.2	109	105	15.7	5 200	6 900	3478	3420	20.8	50.0	43.5	67.0	74.0	3.6	3.2	0.37	1.64	0.90	0.462	0.256
	87.312	30.162	30.886	23.812	3.6	3.2	120	120	18.2	4 600	6 200	3581R	3525	20.5	48.0	45.5	75.0	81.0	3.6	3.2	0.31	1.96	1.08	0.622	0.300
95.250	27.783	29.901	22.225	0.8	2.4	129	122	18.8	4 500	5 900	449	432	18.4	44.0	43.5	83.0	87.0	0.8	2.4	0.28	2.11	1.16	0.686	0.384	
34.980	59.131	15.875	16.764	11.938	SP	1.2	44.9	48.5	6.85	6 400	8 500	L68149	L68110	13.2	45.5	39.0	53.0	56.0	3.5	1.2	0.42	1.44	0.79	0.112	0.056
	59.975	15.875	16.764	11.938	SP	1.2	44.9	48.5	6.85	6 400	8 500	L68149	L68111	13.2	45.5	39.0	53.0	56.0	3.5	1.2	0.42	1.44	0.79	0.112	0.063
35.000	79.375	23.812	25.400	19.050	0.8	0.8	101	105	15.8	5 000	6 700	26883R	26822	16.4	42.5	42.0	71.0	74.0	0.8	0.8	0.32	1.88	1.04	0.414	0.186
	80.000	21.000	22.403	17.826	0.8	1.2	85.0	74.8	11.4	4 900	6 600	339	332	15.1	42.5	41.5	73.0	75.0	0.8	1.2	0.27	2.20	1.21	0.385	0.144
35.717	72.233	25.400	25.400	19.842	3.6	2.4	83.8	87.4	12.4	5 700	7 600	HM88648	HM88610	20.7	52.0	42.5	60.0	69.0	3.6	2.4	0.55	1.10	0.60	0.291	0.185
36.487	73.025	23.812	24.608	19.050	1.6	0.8	90.1	87.3	13.1	5 600	7 400	25880R	25821	15.8	44.0	42.0	65.0	68.0	1.6	0.8	0.29	2.07	1.14	0.294	0.165
	73.025	23.812	25.654	19.050	3.6	0.8	92.6	92.2	13.8	5 400	7 200	2794R	2735X	15.9	49.0	42.5	66.0	69.0	3.6	0.8	0.30	1.98	1.09	0.344	0.134
36.512	76.200	29.370	28.575	23.020	3.6	0.8	99.5	107	15.2	5 400	7 200	HM89449	HM89411	23.9	54.0	44.5	65.0	73.0	3.6	0.8	0.55	1.10	0.60	0.386	0.258
	79.375	23.812	25.400	19.050	0.8	0.8	101	105	15.8	5 000	6 700	26877R	26822	16.4	44.0	43.0	71.0	74.0	0.8	0.8	0.32	1.88	1.04	0.404	0.186
	79.375	29.370	29.771	23.812	0.8	3.2	109	105	15.7	5 200	6 900	3479	3420	20.8	45.5	44.5	67.0	74.0	0.8	3.2	0.37	1.64	0.90	0.429	0.259
	85.725	30.162	30.162	23.812	0.8	3.2	135	136	20.3	4 800	6 400	3878	3820	22.9	48.0	47.0	73.0	81.0	0.8	3.2	0.40	1.49	0.82	0.605	0.285
38.000	63.000	17.000	17.000	13.500	SP	SP	54.7	58.2	8.25	6 000	8 000	JL69349	JL69310	14.6	49.0	41.0	60.0	56.5	3.5	1.2	0.42	1.44	0.79	0.128	0.070
38.100	63.500	12.700	11.908	9.525	1.6	0.8	32.1	33.1	4.60	5 800	7 700	13889	13830	11.9	45.0	42.5	59.0	60.0	1.6	0.8	0.35	1.73	0.95	0.104	0.045

[Notes] 1) SP indicates the specially chamfered from.
2) To the bearings with supplementary code "J" attached at the front of bearing number, tolerances shown in table 7-8 on page A72 are applied.

[Remark] Inch series tapered roller bearings with bore diameter larger than 100 mm are shown in catalog "large size ball & roller bearings".

Single-row tapered roller bearings
inch series

d (38.100) ~ (40.000) mm

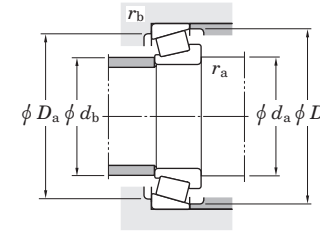
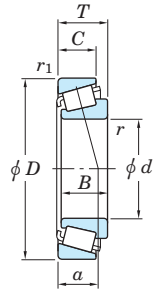

Boundary dimensions (mm)							Basic load ratings (kN)		Fatigue load limit	Limiting speeds (min ⁻¹)		Bearing No.	Load center (mm)	Mounting dimensions (mm)						Constant e	Axial load factors		(Refer.) Mass (kg)		
d	D	T	B	C	$r_1^{(1)}$ min.	r_1 min.	C_r	C_{0r}	(kN) C_u	Grease lub.	Oil lub.			Inner ring	Outer ring	d_a	d_b	D_a	D_b		r_a max.	r_b max.	Y_1	Y_0	Inner ring
38.100	65.088	12.700	11.908	9.525	1.6	0.8	32.1	33.1	4.60	5 800	7 700	13889	13836	11.9	45.0	42.5	59.0	61.0	1.6	0.8	0.35	1.73	0.95	0.104	0.046
	65.088	18.034	18.288	13.970	SP	1.2	53.9	56.5	8.15	5 800	7 800	LM29748	LM29710	13.8	49.0	42.5	59.0	62.0	3.5	1.2	0.33	1.80	0.99	0.154	0.079
	65.088	19.812	18.288	15.748	2.4	1.2	53.9	56.5	8.15	5 800	7 800	LM29749	LM29711	15.6	46.0	42.5	58.0	62.0	2.4	1.2	0.33	1.80	0.99	0.159	0.092
	69.012	19.050	19.050	15.083	2.0	2.4	61.7	62.0	8.95	5 600	7 500	13687	13621	16.1	46.5	43.0	61.0	65.0	2.0	2.4	0.40	1.49	0.82	0.191	0.102
	71.438	15.875	16.520	11.908	1.6	1.0	57.6	53.8	7.70	5 700	7 600	19150R	19281	14.5	45.0	43.0	63.0	66.0	1.6	1.0	0.44	1.35	0.74	0.167	0.105
	71.996	17.018	16.520	14.288	1.6	1.6	57.6	53.8	7.70	5 700	7 600	19150R	19283	15.7	45.0	43.0	63.0	66.0	1.6	1.6	0.44	1.35	0.74	0.167	0.132
	71.996	19.000	20.638	14.237	3.6	1.6	62.3	61.3	8.90	5 600	7 400	16150	16282	15.0	49.5	43.0	63.0	67.0	3.6	1.6	0.40	1.49	0.82	0.207	0.121
	72.238	20.638	20.638	15.875	3.6	1.2	62.3	61.3	8.90	5 600	7 400	16150	16284	16.6	49.5	43.0	63.0	67.0	3.6	1.2	0.40	1.49	0.82	0.207	0.144
	72.238	23.812	20.638	19.050	3.6	2.4	62.3	61.3	8.90	5 600	7 400	16150	16283	19.8	49.5	43.0	61.0	67.0	3.6	2.4	0.40	1.49	0.82	0.207	0.183
	73.025	23.812	25.654	19.050	3.6	0.8	92.6	92.2	13.8	5 400	7 200	2788R	2735X	15.9	50.0	43.5	66.0	69.0	3.6	0.8	0.30	1.98	1.09	0.308	0.134
	76.200	23.812	25.654	19.050	3.6	0.8	92.6	92.2	13.8	5 400	7 200	2788R	2729	15.9	50.0	43.5	68.0	70.0	3.6	0.8	0.30	1.98	1.09	0.308	0.189
	79.375	29.370	29.771	23.812	3.6	3.2	109	105	15.7	5 200	6 900	3490	3420	20.8	52.0	45.9	67.0	74.0	3.6	3.2	0.37	1.64	0.90	0.419	0.256
	80.035	21.432	20.940	15.875	1.6	1.6	71.6	65.9	9.70	5 300	7 000	28150	28317	16.9	45.5	43.5	69.0	73.0	1.6	1.6	0.40	1.49	0.82	0.285	0.201
	80.035	24.608	23.698	18.512	0.8	1.6	91.6	91.6	13.3	5 200	6 900	27880	27820	22.2	48.0	47.0	68.0	75.0	0.8	1.6	0.56	1.07	0.59	0.378	0.208
	80.035	24.608	23.698	18.512	3.6	1.6	91.6	91.6	13.3	5 200	6 900	27881	27820	22.2	53.0	47.0	68.0	75.0	3.6	1.6	0.56	1.07	0.59	0.378	0.208
	82.550	29.370	28.575	23.020	0.8	3.2	109	117	16.9	4 900	6 600	HM801346	HM801310	24.4	51.0	49.0	68.0	78.0	0.8	3.2	0.55	1.10	0.60	0.483	0.282
	82.550	29.370	28.575	23.020	2.4	3.2	109	117	16.9	4 900	6 600	HM801346X	HM801310	24.4	54.0	49.0	68.0	78.0	2.4	3.2	0.55	1.10	0.60	0.483	0.282
	82.931	23.812	25.400	19.050	0.8	0.8	96.8	100	15.1	4 800	6 300	25572	25520	17.5	46.0	46.0	74.0	77.0	0.8	0.8	0.33	1.79	0.99	0.437	0.203
	88.501	26.988	29.083	22.225	3.6	1.6	123	112	17.2	4 900	6 500	418	414	16.9	51.0	44.5	77.0	80.0	3.6	1.6	0.26	2.28	1.25	0.523	0.325
	90.488	39.688	40.386	33.338	1.6	3.2	166	169	25.9	4 500	6 000	4375	4335	25.6	51.0	48.5	77.0	85.0	1.6	3.2	0.28	2.11	1.16	0.841	0.459
101.600	34.925	36.068	26.988	3.6	3.2	164	159	24.8	4 000	5 300	525	522	22.2	54.0	48.0	89.0	95.0	3.6	3.2	0.29	2.10	1.16	1.05	0.411	
39.688	73.025	16.667	17.462	12.700	0.8	1.6	57.6	55.8	8.15	5 200	6 900	18587	18520	14.5	46.0	46.0	66.0	69.0	0.8	1.6	0.35	1.71	0.94	0.215	0.085
	73.025	23.812	25.654	19.050	3.6	0.8	92.6	92.2	13.8	5 400	7 200	2789R	2735X	15.9	52.0	45.0	66.0	69.0	3.6	0.8	0.30	1.98	1.09	0.288	0.134
	80.167	29.370	30.391	23.812	0.8	3.2	114	106	16.2	5 000	6 700	3386	3320	18.7	46.5	45.5	70.0	75.0	0.8	3.2	0.27	2.20	1.21	0.442	0.217
	84.138	29.370	30.391	23.812	3.6	3.2	114	106	16.2	5 000	6 700	3382	3328	18.7	52.0	45.5	72.0	76.0	3.6	3.2	0.27	2.20	1.21	0.438	0.312
40.000	76.200	20.638	20.940	15.507	1.6	1.2	71.6	65.9	9.70	5 300	7 000	28158	28300	16.5	47.5	45.0	68.0	71.0	1.6	1.2	0.40	1.49	0.82	0.266	0.137
	80.000	21.000	22.403	17.826	3.6	1.2	85.0	74.8	11.4	4 900	6 600	344	332	15.1	52.0	45.5	73.0	75.0	3.6	1.2	0.27	2.20	1.21	0.334	0.144

[Note] 1) SP indicates the specially chamfered from.

[Remark] Inch series tapered roller bearings with bore diameter larger than 100 mm are shown in catalog "large size ball & roller bearings".

Single-row tapered roller bearings
inch series

d (40.000) ~ 42.070 mm

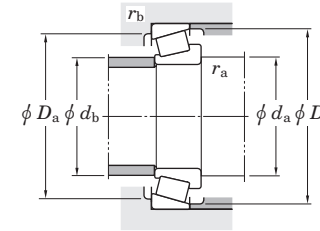
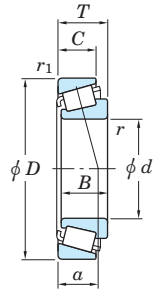

Boundary dimensions (mm)							Basic load ratings (kN)		Fatigue load limit (kN)	Limiting speeds (min ⁻¹)		Bearing No.	Load center (mm)	Mounting dimensions (mm)						Constant e	Axial load factors		(Refer.) Mass (kg)		
d	D	T	B	C	$r_{min.}$	$r1_{min.}$	C_r	C_{0r}	C_u	Grease lub.	Oil lub.			Inner ring	Outer ring	d_a	d_b	D_a	D_b		$r_{a,max.}$	$r_{b,max.}$	Y_1	Y_0	Inner ring
40.000	80.000	21.000	22.403	17.826	0.8	1.2	85.0	74.8	11.4	4 900	6 600	344A	332	15.1	46.0	45.5	73.0	75.0	0.8	1.2	0.27	2.20	1.21	0.334	0.144
	85.000	20.638	21.692	17.462	0.8	1.2	89.6	81.7	12.4	4 600	6 200	350A	354A	15.5	47.5	46.5	77.0	80.0	0.8	1.2	0.31	1.96	1.08	0.416	0.162
	88.501	26.988	29.083	22.225	3.6	1.6	123	112	17.2	4 900	6 500	420	414	16.9	52.0	46.0	77.0	80.0	3.6	1.6	0.26	2.28	1.25	0.465	0.325
	107.950	36.512	36.957	28.575	3.6	3.2	172	172	26.8	3 800	5 100	543	532X	23.9	57.0	50.0	94.0	100.0	3.6	3.2	0.30	2.03	1.11	1.17	0.570
40.483	82.550	29.370	28.575	23.020	3.6	3.2	109	117	16.9	4 900	6 600	HM801349	HM801310	24.4	58.0	49.0	68.0	78.0	3.6	3.2	0.55	1.10	0.60	0.450	0.282
41.275	73.025	16.667	17.462	12.700	3.6	1.6	57.6	55.8	8.15	5 200	6 900	18590	18520	14.5	53.0	46.0	66.0	69.0	3.6	1.6	0.35	1.71	0.94	0.199	0.085
	73.431	19.558	19.812	14.732	3.6	0.8	72.5	73.0	10.6	5 200	7 000	LM501349	LM501310	16.1	53.0	46.5	67.0	70.0	3.6	0.8	0.40	1.50	0.83	0.227	0.107
	73.431	21.430	19.812	16.604	3.6	0.8	72.5	73.0	10.6	5 200	7 000	LM501349	LM501314	18.0	53.0	46.5	66.0	70.0	3.6	0.8	0.40	1.50	0.83	0.227	0.126
	73.431	23.012	19.812	18.186	3.6	2.4	72.5	73.0	10.6	5 200	7 000	LM501349	LM501311	16.1	53.0	46.5	64.0	70.0	3.6	2.4	0.40	1.50	0.83	0.227	0.140
	76.200	18.009	17.384	14.288	1.6	1.6	64.7	63.3	9.15	5 200	6 900	11162R	11300	17.5	49.0	46.5	67.0	72.0	1.6	1.6	0.49	1.23	0.68	0.221	0.127
	76.200	22.225	23.020	17.462	3.6	0.8	82.9	83.3	12.3	5 200	6 900	24780R	24720	17.4	54.0	47.0	68.0	72.0	3.6	0.8	0.39	1.53	0.84	0.275	0.148
	80.000	21.000	22.403	17.826	0.8	1.2	85.0	74.8	11.4	4 900	6 600	336	332	15.1	47.0	46.0	73.0	75.0	0.8	1.2	0.27	2.20	1.21	0.325	0.144
	80.000	21.000	22.403	17.826	3.6	1.2	85.0	74.8	11.4	4 900	6 600	342	332	15.1	53.0	46.0	73.0	75.0	3.6	1.2	0.27	2.20	1.21	0.317	0.144
	82.550	26.543	25.654	20.193	3.6	3.2	105	105	15.4	4 900	6 500	M802048	M802011	23.3	57.0	50.6	70.0	79.0	3.6	3.2	0.55	1.10	0.60	0.403	0.227
	85.725	30.162	30.162	23.812	3.6	1.2	135	136	20.3	4 800	6 400	3877	3821	22.9	57.0	50.3	75.0	81.0	3.6	1.2	0.40	1.49	0.82	0.506	0.324
	87.312	30.162	30.886	23.812	0.8	3.2	120	120	18.2	4 600	6 200	3576R	3525	20.5	49.0	48.0	75.0	81.0	0.8	3.2	0.31	1.96	1.08	0.533	0.300
	88.501	26.988	29.083	22.225	3.6	1.6	123	112	17.2	4 900	6 500	419	414	16.9	54.0	47.0	77.0	80.0	3.6	1.6	0.26	2.28	1.25	0.441	0.325
	88.900	20.638	22.225	16.513	3.6	1.2	92.9	87.3	13.3	4 400	5 800	365A	362A	16.1	55.0	48.5	81.0	84.0	3.6	1.2	0.32	1.88	1.03	0.458	0.164
	88.900	30.162	29.370	23.020	0.8	3.2	124	125	18.5	4 600	6 100	HM803145	HM803110	26.1	54.0	53.0	74.0	85.0	0.8	3.2	0.55	1.10	0.60	0.577	0.318
	88.900	30.162	29.370	23.020	3.6	3.2	124	125	18.5	4 600	6 100	HM803146	HM803110	26.1	60.0	53.0	74.0	85.0	3.6	3.2	0.55	1.10	0.60	0.574	0.318
	90.488	39.688	40.386	33.338	3.6	3.2	166	169	25.9	4 500	6 000	4388	4335	25.6	57.0	51.0	77.0	85.0	3.6	3.2	0.28	2.11	1.16	0.775	0.454
	93.662	31.750	31.750	26.195	0.8	3.2	132	134	20.2	4 400	5 800	46162	46368	24.0	52.0	51.0	79.0	87.0	0.8	3.2	0.40	1.49	0.82	0.695	0.403
	95.250	30.162	29.370	23.020	3.6	3.2	130	140	20.7	3 300	4 400	HM804840	HM804810	26.5	61.0	54.0	81.0	91.0	3.6	3.2	0.55	1.10	0.60	0.719	0.351
	101.600	34.925	36.068	26.988	3.6	3.2	164	159	24.8	4 000	5 300	526	522	22.2	57.0	50.0	89.0	95.0	3.6	3.2	0.29	2.10	1.16	1.02	0.411
	104.775	36.512	36.512	28.575	1.6	3.2	176	195	29.3	3 800	5 100	HM807035	HM807010	29.3	60.0	57.0	89.0	100.0	1.6	3.2	0.49	1.23	0.68	1.19	0.497
42.070	90.488	39.688	40.386	33.338	3.6	3.2	166	169	25.9	4 500	6 000	4395	4335	25.6	58.0	51.0	77.0	85.0	3.6	3.2	0.28	2.11	1.16	0.751	0.459

[Remark] Inch series tapered roller bearings with bore diameter larger than 100 mm are shown in catalog "large size ball & roller bearings".

Single-row tapered roller bearings
inch series

d 42.862 ~ 45.000 mm

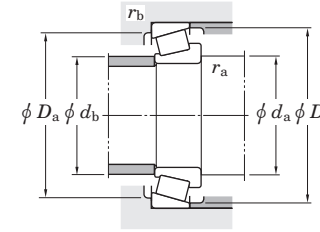
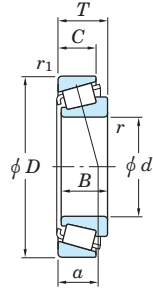

Boundary dimensions (mm)							Basic load ratings (kN)		Fatigue load limit (kN)	Limiting speeds (min ⁻¹)		Bearing No.	Load center (mm)	Mounting dimensions (mm)						Constant e	Axial load factors		(Refer.) Mass (kg)		
d	D	T	B	C	r _{min.}	r _{1 min.}	C _r	C _{0r}	C _u	Grease lub.	Oil lub.			Inner ring	Outer ring	d _a	d _b	D _a	D _b		r _{a max.}	r _{b max.}	Y ₁	Y ₀	Inner ring
42.862	76.992	17.463	17.145	11.908	1.6	1.6	60.8	62.2	8.95	5 000	6 600	12168	12303	17.5	51.0	48.5	68.0	73.0	1.6	1.6	0.51	1.19	0.65	0.220	0.097
42.875	79.375	23.812	25.400	19.050	3.6	0.8	101	105	15.8	5 000	6 700	26884R	26822	16.1	55.0	48.5	71.0	74.0	3.6	0.8	0.32	1.88	1.04	0.314	0.186
	82.931	23.812	25.400	19.050	3.6	0.8	96.8	100	15.1	4 800	6 300	25577	25520	17.5	55.0	49.0	74.0	77.0	3.6	0.8	0.33	1.79	0.99	0.382	0.200
44.450	73.025	18.258	18.258	15.083	1.6	1.6	59.4	65.5	9.50	5 100	6 800	L102849	L102810	14.6	51.0	49.0	66.0	69.0	1.6	1.6	0.32	1.88	1.04	0.183	0.102
	76.992	17.463	17.145	11.908	1.6	1.6	60.8	62.2	8.95	5 000	6 600	12175	12303	17.5	52.0	49.5	68.0	73.0	1.6	1.6	0.51	1.19	0.65	0.206	0.097
	79.375	17.462	17.462	13.495	2.8	1.6	59.2	59.1	8.65	4 800	6 400	18685	18620	16.0	54.0	49.5	71.0	74.0	2.8	1.6	0.37	1.60	0.88	0.214	0.126
	82.931	23.812	25.400	19.050	5.2	0.8	96.8	100	15.1	4 800	6 300	25582	25520	17.5	59.0	51.0	74.0	77.0	5.2	0.8	0.33	1.79	0.99	0.361	0.200
	84.138	30.162	30.886	23.812	3.6	3.2	120	120	18.2	4 600	6 200	3578R	3520	20.5	57.0	51.0	74.0	79.5	3.6	3.2	0.31	1.96	1.08	0.479	0.221
	85.000	20.638	21.692	17.462	2.4	1.2	89.6	81.7	12.4	4 600	6 200	355	354A	15.5	54.0	50.0	77.0	80.0	2.4	1.2	0.31	1.96	1.08	0.344	0.160
	85.000	20.638	21.692	17.462	0.8	1.2	89.6	81.7	12.4	4 600	6 200	355A	354A	15.5	51.0	50.0	77.0	80.0	0.8	1.2	0.31	1.96	1.08	0.344	0.160
	88.900	30.162	29.370	23.020	3.6	3.2	124	125	18.5	4 600	6 100	HM803149	HM803110	26.1	62.0	53.4	74.0	85.0	3.6	3.2	0.55	1.10	0.60	0.525	0.318
	93.662	31.750	31.750	25.400	3.6	3.2	131	123	18.8	4 400	5 900	49175	49368	22.9	59.0	53.0	82.0	87.0	3.6	3.2	0.36	1.67	0.92	0.645	0.371
	93.662	31.750	31.750	26.195	0.8	3.2	132	134	20.2	4 400	5 800	46175	46368	24.0	55.0	54.0	79.0	87.0	0.8	3.2	0.40	1.49	0.82	0.609	0.403
	93.662	31.750	31.750	26.195	3.6	3.2	132	134	20.2	4 400	5 800	46176	46368	24.0	60.0	54.0	79.0	87.0	3.6	3.2	0.40	1.49	0.82	0.609	0.403
	95.250	27.783	28.575	22.225	0.8	2.4	135	141	21.6	4 100	5 400	33885	33821	20.4	53.0	53.0	85.0	90.0	0.8	2.4	0.33	1.82	1.00	0.714	0.264
	95.250	27.783	29.901	22.225	3.6	0.8	129	122	18.8	4 500	5 900	438	432A	18.4	57.0	51.0	84.0	87.0	3.6	0.8	0.28	2.11	1.16	0.555	0.375
	95.250	30.162	29.370	23.020	0.8	2.4	130	140	20.7	3 300	4 400	HM804842	HM804810	26.5	57.0	57.0	81.0	91.0	0.8	2.4	0.55	1.10	0.60	0.673	0.351
	95.250	30.162	29.370	23.020	3.6	2.4	130	140	20.7	3 300	4 400	HM804843	HM804810	26.5	63.0	57.0	81.0	91.0	3.6	2.4	0.55	1.10	0.60	0.670	0.351
	98.425	30.162	31.750	25.400	0.8	3.2	143	143	21.9	3 900	5 200	49576	49520	24.1	55.0	54.0	88.0	96.0	0.8	3.2	0.40	1.50	0.82	0.856	0.384
	101.600	34.925	36.068	26.988	3.6	3.2	164	159	24.8	4 000	5 300	527	522	22.2	59.0	53.0	89.0	95.0	3.6	3.2	0.29	2.10	1.16	0.939	0.411
	104.775	36.512	36.512	28.575	3.6	3.2	176	195	29.3	3 800	5 100	HM807040	HM807010	29.3	66.0	59.0	89.0	100.0	3.6	3.2	0.49	1.23	0.68	1.13	0.497
111.125	38.100	36.957	30.162	3.6	3.2	172	172	26.8	3 800	5 100	535	532A	23.9	60.0	54.0	95.0	100.0	3.6	3.2	0.30	2.03	1.11	1.09	0.746	
120.650	41.275	41.275	31.750	3.6	3.2	218	217	34.0	3 500	4 600	615	612	27.3	62.0	56.0	105.0	110.0	3.6	3.2	0.31	1.91	1.05	1.48	0.853	
44.983	93.264	30.162	30.302	23.812	3.6	3.2	129	137	20.9	4 200	5 500	3776	3720	22.2	59.0	53.0	82.0	88.0	3.6	3.2	0.34	1.77	0.97	0.650	0.288
45.000	85.000	20.638	21.692	17.462	1.6	1.2	89.6	81.7	12.4	4 600	6 200	358	354A	15.5	52.5	50.0	77.0	80.0	1.6	1.2	0.31	1.96	1.08	0.338	0.162

[Remark] Inch series tapered roller bearings with bore diameter larger than 100 mm are shown in catalog 'large size ball & roller bearings'.

Single-row tapered roller bearings
inch series

d 45.242 ~ 49.212 mm

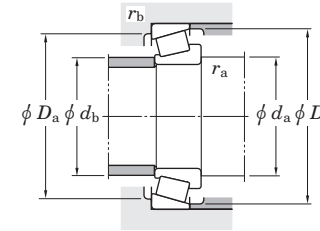
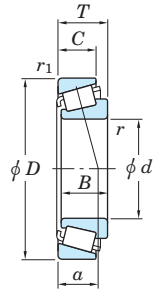

Boundary dimensions (mm)							Basic load ratings (kN)		Fatigue load limit	Limiting speeds (min ⁻¹)		Load center (mm) a	Mounting dimensions (mm)						Constant e	Axial load factors		(Refer.) Mass (kg)			
d	D	T	B	C	$r_{min.}$	$r_{1 min.}$	C_r	C_{0r}	(kN) C_u	Grease lub.	Oil lub.		Inner ring	Outer ring	d_a	d_b	D_a	D_b		$r_{a max.}$	$r_{b max.}$	Y_1	Y_0	Inner ring	Outer ring
45.242	73.431	19.558	19.812	15.748	3.6	0.8	70.0	78.1	11.4	5 100	6 700	LM102949	LM102910	14.7	56.0	50.0	68.0	70.0	3.6	0.8	0.31	1.97	1.08	0.209	0.100
	77.788	19.842	19.842	15.080	3.6	0.8	71.7	73.5	10.7	4 900	6 500	LM603049	LM603011	17.5	57.0	50.0	71.0	74.0	3.6	0.8	0.43	1.41	0.77	0.243	0.120
	77.788	21.430	19.842	16.667	3.6	0.8	71.7	73.5	10.7	4 900	6 500	LM603049	LM603012	19.1	57.0	50.0	71.0	74.0	3.6	0.8	0.43	1.41	0.77	0.243	0.138
	79.974	19.842	19.842	15.080	3.6	0.8	71.7	73.5	10.7	4 900	6 500	LM603049	LM603014	17.5	57.0	50.0	71.0	74.0	3.6	0.8	0.43	1.41	0.77	0.243	0.152
45.618	85.000	23.812	25.400	19.050	3.6	2.4	96.8	100	15.1	4 800	6 300	25590	25526	17.5	58.0	51.0	74.0	78.0	3.6	2.4	0.33	1.79	0.99	0.344	0.241
45.987	74.976	18.000	18.000	14.000	2.4	1.6	66.2	74.6	10.8	5 000	6 600	LM503349R	LM503310	16.0	53.0	51.0	67.0	72.0	2.4	1.6	0.40	1.49	0.82	0.207	0.095
46.038	79.375	17.462	17.462	13.495	2.8	1.6	59.2	59.1	8.65	4 800	6 400	18690	18620	16.0	56.0	51.0	71.0	74.0	2.8	1.6	0.37	1.60	0.88	0.208	0.123
	85.000	20.638	21.692	17.462	3.6	1.2	89.6	81.7	12.4	4 600	6 200	359A	354A	15.5	57.0	51.0	77.0	80.0	3.6	1.2	0.31	1.96	1.08	0.323	0.160
	85.000	20.638	21.692	17.462	2.4	1.2	89.6	81.7	12.4	4 600	6 200	359S	354A	15.5	55.0	51.0	77.0	80.0	2.4	1.2	0.31	1.96	1.08	0.323	0.160
	85.000	25.400	25.608	20.638	3.6	1.2	100	106	16.0	4 600	6 100	2984	2924	18.9	58.0	52.0	76.0	80.0	3.6	1.2	0.35	1.73	0.95	0.389	0.220
47.625	88.900	20.638	22.225	16.513	3.6	1.2	92.9	87.3	13.3	4 400	5 800	369A	362A	16.1	60.0	53.0	81.0	84.0	3.6	1.2	0.32	1.88	1.03	0.373	0.164
	88.900	25.400	25.400	19.050	3.6	3.2	109	112	16.6	4 400	5 900	M804049	M804010	23.6	62.0	55.0	76.0	85.0	3.6	3.2	0.55	1.10	0.60	0.450	0.216
	95.250	30.162	29.370	23.020	3.6	3.2	130	140	20.7	3 300	4 400	HM804846	HM804810	26.5	64.0	57.0	81.0	91.0	3.6	3.2	0.55	1.10	0.60	0.617	0.351
	96.838	21.000	21.946	15.875	0.8	0.8	101	101	15.3	3 900	5 200	386A	382A	17.4	56.0	55.0	89.0	92.0	0.8	0.8	0.35	1.69	0.93	0.563	0.177
	101.600	34.925	36.068	26.988	3.6	3.2	164	159	24.8	4 000	5 300	528	522	22.2	62.0	55.0	89.0	95.0	3.6	3.2	0.29	2.10	1.16	0.871	0.411
	104.775	30.162	29.317	24.605	4.8	3.2	136	144	22.2	3 700	4 900	463	453X	23.6	65.0	56.0	92.0	98.0	4.8	3.2	0.34	1.79	0.98	0.838	0.372
	104.775	30.162	29.317	24.605	0.8	3.2	136	144	22.2	3 700	4 900	467	453X	23.6	57.0	56.0	92.0	98.0	0.8	3.2	0.34	1.79	0.98	0.844	0.372
	104.775	30.162	30.958	23.812	3.6	3.2	157	165	25.6	3 700	4 900	45282	45220	22.2	64.0	59.0	93.0	99.0	3.6	3.2	0.33	1.80	0.99	0.940	0.345
48.412	95.250	30.162	29.370	23.020	2.4	3.2	130	140	20.7	3 300	4 400	HM804848	HM804810	26.5	63.0	57.5	81.0	91.0	2.4	3.2	0.55	1.10	0.60	0.606	0.351
	95.250	30.162	29.370	23.020	3.6	3.2	130	140	20.7	3 300	4 400	HM804849	HM804810	26.5	66.0	57.5	81.0	91.0	3.6	3.2	0.55	1.10	0.60	0.604	0.351
49.212	88.900	20.638	22.225	16.513	0.8	1.2	92.9	87.3	13.3	4 400	5 800	365S	362A	16.1	55.0	54.0	81.0	84.0	0.8	1.2	0.32	1.88	1.03	0.366	0.164
	104.775	36.512	36.512	28.575	3.6	3.2	176	195	29.3	3 800	5 100	HM807044	HM807010	29.3	69.0	63.0	89.0	100.0	3.6	3.2	0.49	1.23	0.68	1.03	0.497
	114.300	44.450	44.450	34.925	3.6	3.2	237	230	35.1	3 800	5 000	65390	65320	31.7	70.0	60.0	97.0	107.0	3.6	3.2	0.43	1.40	0.77	1.28	0.894
	114.300	44.450	44.450	36.068	3.6	3.2	265	263	35.4	3 700	5 000	HH506348	HH506310	30.6	71.0	61.0	97.0	107.0	3.6	3.2	0.40	1.49	0.82	1.49	0.834

[Remark] Inch series tapered roller bearings with bore diameter larger than 100 mm are shown in catalog "large size ball & roller bearings".

Single-row tapered roller bearings
inch series

d 49.987 ~ (50.800) mm

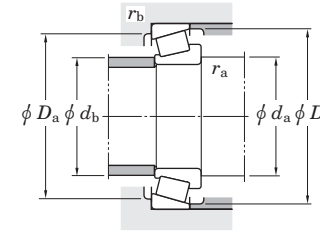
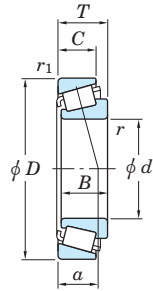

Boundary dimensions (mm)							Basic load ratings (kN)		Fatigue load limit (kN)	Limiting speeds (min ⁻¹)		Bearing No. ¹⁾	Load center (mm)	Mounting dimensions (mm)						Constant e	Axial load factors		(Refer.) Mass (kg)		
d	D	T	B	C	$r_{min.}$	$r1_{min.}$	C_r	C_{0r}	C_u	Grease lub.	Oil lub.			Inner ring	Outer ring	d_a	d_b	D_a	D_b		$r_{a,max.}$	$r_{b,max.}$	Y_1	Y_0	Inner ring
49.987	92.075	24.608	25.400	19.845	2.4	0.8	107	119	17.9	4 200	5 600	28579R	28521	19.9	60.0	56.0	83.0	87.0	2.4	0.8	0.38	1.59	0.87	0.463	0.247
50.000	82.000	21.501	21.501	17.000	3.0	0.5	90.0	97.9	14.7	4 500	6 000	JLM104948	JLM104910	16.2	60.0	55.0	76.0	78.0	3.0	0.5	0.31	1.97	1.08	0.304	0.128
	88.900	20.638	22.225	16.513	2.0	1.2	92.9	87.3	13.3	4 400	5 800	365	362A	16.1	58.0	55.0	81.0	84.0	2.0	1.2	0.32	1.88	1.03	0.346	0.164
	88.900	20.638	22.225	16.513	2.4	1.2	92.9	87.3	13.3	4 400	5 800	366	362A	16.1	59.0	55.0	81.0	84.0	2.4	1.2	0.32	1.88	1.03	0.351	0.166
	90.000	28.000	28.000	23.000	3.0	2.5	132	138	21.1	4 300	5 800	JM205149	JM205110	20.2	62.0	57.0	80.0	85.0	3.0	2.5	0.33	1.82	1.00	0.508	0.243
	105.000	37.000	36.000	29.000	3.0	2.8	186	205	30.6	3 800	5 100	JHM807045	JHM807012	29.4	69.0	63.0	90.0	100.0	3.0	2.8	0.49	1.23	0.68	1.01	0.523
110.000	22.000	21.996	18.824	0.8	1.2	109	116	17.7	3 400	4 500	396	394A	21.3	61.0	60.0	101.0	105.0	0.8	1.2	0.40	1.49	0.82	0.777	0.264	
50.800	80.962	18.258	18.258	14.288	1.6	1.6	67.8	81.1	11.8	4 600	6 100	L305649R	L305610	16.0	58.0	56.0	73.0	77.0	1.6	1.6	0.35	1.69	0.93	0.228	0.119
	82.550	21.590	22.225	16.510	3.6	1.2	77.0	84.3	12.5	4 500	6 000	LM104949	LM104911	16.4	62.0	55.0	75.0	78.0	3.6	1.2	0.31	1.97	1.08	0.287	0.131
	85.725	19.050	18.263	12.700	1.6	1.6	63.8	66.4	9.55	4 400	5 900	18200	18337	22.7	59.0	56.0	76.0	81.0	1.6	1.6	0.57	1.06	0.58	0.268	0.134
	88.900	17.462	17.462	13.495	3.6	1.2	62.5	65.5	9.55	4 400	5 900	18790	18724	17.4	62.0	56.0	78.0	82.0	3.6	1.2	0.41	1.48	0.81	0.226	0.190
	88.900	20.638	22.225	16.513	1.6	1.2	92.9	87.3	13.3	4 400	5 800	368	362A	16.1	58.0	56.0	81.0	84.0	1.6	1.2	0.32	1.88	1.03	0.333	0.164
	88.900	20.638	22.225	16.513	3.6	1.2	92.9	87.3	13.3	4 400	5 800	368A	362A	16.1	62.0	56.0	81.0	84.0	3.6	1.2	0.32	1.88	1.03	0.331	0.164
	88.900	20.638	22.225	16.513	5.2	1.2	92.9	87.3	13.3	4 400	5 800	370A	362A	16.1	65.0	56.0	81.0	84.0	5.2	1.2	0.32	1.88	1.03	0.326	0.164
	92.075	24.608	25.400	19.845	3.6	0.8	107	119	17.9	4 200	5 600	28580R	28521	19.9	63.0	57.0	83.0	87.0	3.6	0.8	0.38	1.59	0.87	0.453	0.247
	93.264	20.638	22.225	15.083	2.4	1.2	105	98.5	15.1	4 200	5 600	375	374	17.1	60.0	57.0	85.0	88.0	2.4	1.2	0.34	1.77	0.97	0.416	0.174
	93.264	30.162	30.302	23.812	3.6	3.2	129	137	20.9	4 200	5 500	3780	3720	22.2	64.0	58.0	82.0	88.0	3.6	3.2	0.34	1.77	0.97	0.547	0.288
	93.264	30.162	30.302	23.812	3.6	0.8	129	137	20.9	4 200	5 500	3780	3730	22.2	64.0	58.0	84.0	88.0	3.6	0.8	0.34	1.77	0.97	0.547	0.293
	95.250	27.783	28.575	22.225	3.6	0.8	135	141	21.6	4 100	5 400	33889	33822	20.4	64.0	58.0	86.0	90.0	3.6	0.8	0.33	1.82	1.00	0.604	0.267
	96.838	21.000	21.946	15.875	0.8	0.8	101	101	15.3	3 900	5 200	385AX	382A	17.4	59.0	58.0	89.0	92.0	0.8	0.8	0.35	1.69	0.93	0.521	0.177
	97.630	24.608	24.608	19.446	3.6	0.8	113	131	19.7	3 900	5 200	28678	28622	21.2	65.0	58.0	88.0	92.0	3.6	0.8	0.40	1.49	0.82	0.569	0.267
	98.425	30.162	30.302	23.812	3.6	3.2	129	137	20.9	4 200	5 500	3780	3732	22.2	64.0	58.0	84.0	90.0	3.6	3.2	0.34	1.77	0.97	0.547	0.433
	101.600	31.750	31.750	25.400	3.6	3.2	143	143	21.9	3 900	5 200	49585	49520	24.1	66.0	59.0	88.0	96.0	3.6	3.2	0.40	1.50	0.82	0.736	0.384
	101.600	34.925	36.068	26.988	0.8	3.2	164	159	24.8	4 000	5 300	529	522	22.2	59.0	58.0	89.0	95.0	0.8	3.2	0.29	2.10	1.16	0.806	0.411
	101.600	34.925	36.068	26.988	3.6	3.2	164	159	24.8	4 000	5 300	529X	522	22.2	65.0	58.0	89.0	95.0	3.6	3.2	0.29	2.10	1.16	0.802	0.411
	104.775	30.162	30.958	23.812	6.4	3.2	157	165	25.6	3 700	4 900	45284	45220	22.2	71.0	59.0	93.0	99.0	6.4	3.2	0.33	1.80	0.99	0.873	0.345
	104.775	36.512	36.512	28.575	3.6	3.2	185	187	28.6	3 900	5 100	59200	59412	26.9	68.0	61.0	92.0	99.0	3.6	3.2	0.40	1.49	0.82	0.767	0.623

[Note] 1) To the bearings with supplementary code "J" attached at the front of bearing number, tolerances shown in table 7-8 on page A72 are applied.

[Remark] Inch series tapered roller bearings with bore diameter larger than 100 mm are shown in catalog "large size ball & roller bearings".

Single-row tapered roller bearings
inch series

d (50.800) ~ (55.000) mm

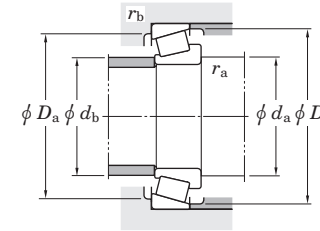
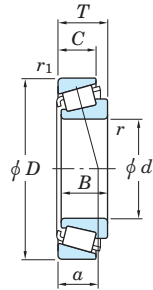

Boundary dimensions (mm)							Basic load ratings (kN)		Fatigue load limit (kN)	Limiting speeds (min ⁻¹)		Bearing No. ¹⁾	Load center (mm)	Mounting dimensions (mm)						Constant e	Axial load factors		(Refer.) Mass (kg)				
d	D	T	B	C	$r_{min.}$	$r_{1 min.}$	C_r	C_{0r}	C_u	Grease lub.	Oil lub.			Inner ring	Outer ring	d_a	d_b	D_a	D_b		$r_{a max.}$	$r_{b max.}$	Y_1	Y_0	Inner ring	Outer ring	
50.800	104.775	36.512	36.512	28.575	3.6	3.2	176	195	29.3	3 800	5 100	HM807046	HM807010	29.3	70.0	63.0	89.0	100.0	3.6	3.2	0.49	1.23	0.68	0.995	0.497		
	104.775	39.688	40.157	33.338	3.6	3.2	189	211	32.3	3 800	5 100			4580	4535	27.3	67.0	61.0	90.0	99.0	3.6	3.2	0.34	1.79	0.98	1.06	0.576
	107.950	36.512	36.957	28.575	3.6	3.2	172	172	26.8	3 800	5 100			537	532X	23.9	65.0	59.0	94.0	100.0	3.6	3.2	0.30	2.03	1.11	0.969	0.569
	112.712	30.162	30.162	23.812	3.6	3.2	184	207	32.1	3 300	4 500			39575	39520	23.3	68.0	61.0	101.0	107.0	3.6	3.2	0.34	1.77	0.97	1.13	0.355
	120.650	41.275	41.275	31.750	3.6	3.2	218	217	34.0	3 500	4 600			619	612	27.3	67.0	61.0	105.0	110.0	3.6	3.2	0.31	1.91	1.05	1.44	0.853
	127.000	44.450	44.450	34.925	3.6	3.2	259	269	41.0	3 300	4 400			65200	65500	35.2	75.0	69.0	107.0	119.0	3.6	3.2	0.49	1.23	0.68	1.86	1.03
51.592	88.900	20.638	22.225	16.513	2.0	1.2	92.9	87.3	13.3	4 400	5 800	368S	362A	16.1	59.0	56.0	81.0	84.0	2.0	1.2	0.32	1.88	1.03	0.321	0.164		
	92.075	24.608	25.400	19.845	3.6	0.8	107	119	17.9	4 200	5 600			28584R	28521	19.9	65.0	58.0	83.0	87.0	3.6	0.8	0.38	1.59	0.87	0.435	0.247
52.388	104.775	30.162	29.317	24.605	1.6	3.2	136	144	22.2	3 700	4 900	468	453X	23.6	62.0	60.0	92.0	98.0	1.6	3.2	0.34	1.79	0.98	0.748	0.372		
	88.900	19.050	19.050	13.492	2.4	2.0	79.1	86.8	12.6	4 200	5 600			LM806649	LM806610	21.5	63.0	60.0	80.0	85.0	2.4	2.0	0.55	1.10	0.60	0.312	0.135
53.975	95.250	27.783	28.575	22.225	1.6	0.8	135	141	21.6	4 100	5 400	33895	33822	20.4	63.0	60.0	86.0	90.0	1.6	0.8	0.33	1.82	1.00	0.550	0.267		
	104.775	30.162	29.317	24.605	3.6	3.2	136	144	22.2	3 700	4 900	456	453X	23.6	68.0	61.0	92.0	98.0	3.6	3.2	0.34	1.79	0.98	0.728	0.372		
	104.775	36.512	36.512	28.575	3.6	3.2	176	195	29.3	3 800	5 100	HM807049	HM807010	29.3	73.0	63.0	89.0	100.0	3.6	3.2	0.49	1.23	0.68	0.921	0.497		
	104.775	39.688	40.157	33.338	3.6	3.2	189	211	32.3	3 800	5 100			4595	4535	27.3	70.0	63.0	90.0	99.0	3.6	3.2	0.34	1.79	0.98	0.981	0.576
	107.950	36.512	36.957	28.575	3.6	3.2	172	172	26.8	3 800	5 100	539	532X	23.9	68.0	61.0	94.0	100.0	3.6	3.2	0.30	2.03	1.11	0.894	0.569		
	107.950	36.512	36.957	28.575	5.6	3.2	172	172	26.8	3 800	5 100	539A	532X	23.9	72.0	61.0	94.0	100.0	5.6	3.2	0.30	2.03	1.11	0.861	0.569		
	117.475	33.338	31.750	23.812	3.6	3.2	162	152	23.2	3 500	4 600	66212R	66462	33.2	73.0	67.0	100.0	111.0	3.6	3.2	0.63	0.96	0.53	1.03	0.552		
	120.650	41.275	41.275	31.750	3.6	3.2	218	217	34.0	3 500	4 600	621	612	27.3	70.0	63.0	105.0	110.0	3.6	3.2	0.31	1.91	1.05	1.36	0.853		
	122.238	33.338	31.750	23.812	3.6	3.2	160	153	23.3	3 300	4 300	66584	66520	35.4	75.0	68.0	105.0	116.0	3.6	3.2	0.67	0.90	0.50	1.25	0.551		
	122.238	43.658	43.764	36.512	3.6	3.2	276	318	43.6	3 200	4 300	5578R	5535	31.1	73.0	67.0	106.0	116.0	3.6	3.2	0.36	1.67	0.92	1.84	0.807		
	123.825	38.100	36.678	30.162	3.6	3.2	202	223	34.8	3 200	4 200	557S	552A	28.7	71.0	65.0	109.0	116.0	3.6	3.2	0.35	1.73	0.95	1.47	0.756		
	127.000	44.450	44.450	34.925	3.6	3.2	259	269	41.0	3 300	4 400	65212	65500	35.2	77.0	71.0	107.0	119.0	3.6	3.2	0.49	1.23	0.68	1.78	1.02		
	54.988	104.775	30.162	29.317	24.605	2.4	3.2	136	144	22.2	3 700	4 900	466	453X	23.6	67.0	61.0	92.0	98.0	2.4	3.2	0.34	1.79	0.98	0.708	0.372	
	54.991	135.755	53.975	56.007	44.450	3.6	3.2	333	357	49.3	3 000	4 000	6381	6320	34.8	76.0	70.0	117.0	126.0	3.6	3.2	0.32	1.85	1.02	2.75	1.37	
55.000	90.000	23.000	23.000	18.500	1.6	0.5	102	115	17.2	4 200	5 500	JLM506849	JLM506810	20.1	63.0	61.0	82.0	86.0	1.6	0.5	0.40	1.49	0.82	0.370	0.183		

[Note] 1) To the bearings with supplementary code "J" attached at the front of bearing number, tolerances shown in table 7-8 on page A72 are applied.

[Remark] Inch series tapered roller bearings with bore diameter larger than 100 mm are shown in catalog "large size ball & roller bearings".

Single-row tapered roller bearings
inch series

d (55.000) ~ (60.000) mm

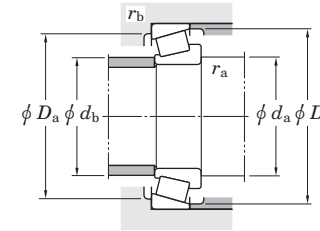
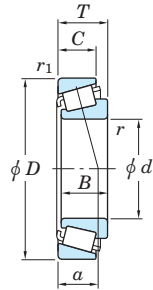

Boundary dimensions (mm)							Basic load ratings (kN)		Fatigue load limit (kN)	Limiting speeds (min ⁻¹)		Bearing No. ¹⁾	Load center (mm)	Mounting dimensions (mm)						Constant e	Axial load factors		(Refer.) Mass (kg)		
d	D	T	B	C	$r_{min.}$	$r_{1 min.}$	C_r	C_{0r}	C_u	Grease lub.	Oil lub.			Inner ring	Outer ring	d_a	d_b	D_a	D_b		$r_{a max.}$	$r_{b max.}$	Y_1	Y_0	Inner ring
55.000	95.000	29.000	29.000	23.500	1.6	2.8	138	150	23.0	4 000	5 300	JM207049	JM207010	21.3	64.0	62.0	85.0	91.0	1.6	2.8	0.33	1.79	0.99	0.567	0.256
	96.838	21.000	21.946	15.875	2.4	0.8	101	101	15.3	3 900	5 200	385	382A	17.4	65.0	61.0	89.0	92.0	2.4	0.8	0.35	1.69	0.93	0.461	0.177
	96.838	21.000	21.946	15.875	3.6	0.8	101	101	15.3	3 900	5 200	385X	382A	17.4	67.0	61.0	89.0	92.0	3.6	0.8	0.35	1.69	0.93	0.459	0.177
	110.000	39.000	39.000	32.000	3.0	2.5	220	224	34.7	3 600	4 900	JH307749	JH307710	26.8	71.0	64.0	97.0	104.0	3.0	2.5	0.35	1.73	0.95	1.16	0.560
55.562	97.630	24.608	24.608	19.446	3.6	0.8	113	131	19.7	3 900	5 200	28680	28622	21.2	68.0	62.0	88.0	92.0	3.6	0.8	0.40	1.49	0.82	0.492	0.267
	122.238	43.658	43.764	36.512	1.2	3.2	276	318	43.6	3 200	4 300	5566R	5535	31.1	70.0	68.0	106.0	116.0	1.2	3.2	0.36	1.67	0.92	1.82	0.807
	127.000	36.512	36.512	26.988	3.6	3.2	209	235	36.2	3 000	4 000	HM813840	HM813810	32.9	76.0	70.0	111.0	121.0	3.6	3.2	0.50	1.20	0.66	1.72	0.606
55.575	96.838	21.000	21.946	15.875	2.4	0.8	101	101	15.3	3 900	5 200	389	382A	17.4	65.0	61.0	89.0	92.0	2.4	0.8	0.35	1.69	0.93	0.452	0.177
57.150	96.838	21.000	21.946	15.875	2.4	0.8	101	101	15.3	3 900	5 200	387	382A	17.4	66.0	62.0	89.0	92.0	2.4	0.8	0.35	1.69	0.93	0.428	0.177
	96.838	21.000	21.946	15.875	3.6	0.8	101	101	15.3	3 900	5 200	387A	382A	17.4	69.0	62.0	89.0	92.0	3.6	0.8	0.35	1.69	0.93	0.426	0.177
	96.838	21.000	21.946	15.875	5.2	0.8	101	101	15.3	3 900	5 200	387AS	382A	17.4	72.0	62.0	89.0	92.0	5.2	0.8	0.35	1.69	0.93	0.422	0.177
	96.838	21.000	21.946	15.875	0.8	0.8	101	101	15.3	3 900	5 200	387S	382A	17.4	63.0	62.0	89.0	92.0	0.8	0.8	0.35	1.69	0.93	0.431	0.177
	98.425	21.000	21.946	17.826	2.4	0.8	101	101	15.3	3 900	5 200	387	382	17.4	66.0	62.0	89.0	92.0	2.4	0.8	0.35	1.69	0.93	0.428	0.223
	104.775	30.162	29.317	24.605	2.4	3.2	136	144	22.2	3 700	4 900	462	453X	23.6	67.0	63.0	92.0	98.0	2.4	3.2	0.34	1.79	0.98	0.685	0.372
	104.775	30.162	29.317	24.605	3.6	3.2	136	144	22.2	3 700	4 900	469	453X	23.6	70.0	63.0	92.0	98.0	3.6	3.2	0.34	1.79	0.98	0.682	0.372
	104.775	30.162	30.958	23.812	6.4	0.8	157	165	25.6	3 700	4 900	45291	45221	22.2	76.0	65.0	95.0	99.0	6.4	0.8	0.33	1.80	0.99	0.742	0.350
	112.712	30.162	30.048	23.812	3.6	3.2	139	164	25.1	3 400	4 500	3979	3920	25.9	72.0	66.0	99.0	106.0	3.6	3.2	0.40	1.49	0.82	0.916	0.448
	112.712	30.162	30.162	23.812	3.6	3.2	184	207	32.1	3 300	4 500	39580	39520	23.3	72.0	66.0	101.0	107.0	3.6	3.2	0.34	1.77	0.97	1.05	0.355
	112.712	30.162	30.162	23.812	7.9	3.2	184	207	32.1	3 300	4 500	39581	39520	23.3	81.0	66.0	101.0	107.0	7.9	3.2	0.34	1.77	0.97	1.03	0.355
	117.475	30.162	30.162	23.812	3.6	3.2	148	179	27.4	3 200	4 200	33225	33462	27.8	74.0	68.0	104.0	112.0	3.6	3.2	0.44	1.38	0.76	1.13	0.442
	120.650	41.275	41.275	31.750	3.6	3.2	218	217	34.0	3 500	4 600	623	612	27.3	72.0	66.0	105.0	110.0	3.6	3.2	0.31	1.91	1.05	1.27	0.853
	127.000	44.450	44.450	34.925	3.6	3.2	259	269	41.0	3 300	4 400	65225	65500	35.2	80.0	71.0	107.0	119.0	3.6	3.2	0.49	1.23	0.68	1.69	1.02
57.531	96.838	21.000	21.946	15.875	3.6	0.8	101	101	15.3	3 900	5 200	388A	382A	17.4	69.0	63.0	89.0	92.0	3.6	0.8	0.35	1.69	0.93	0.420	0.177
59.972	122.238	33.338	31.750	23.812	0.8	3.2	160	153	23.3	3 300	4 300	66589	66520	35.4	74.0	73.0	105.0	116.0	0.8	3.2	0.67	0.90	0.50	1.11	0.551
60.000	95.000	24.000	24.000	19.000	5.0	2.5	108	125	18.9	3 900	5 200	JLM508748	JLM508710	21.2	75.0	66.0	85.0	91.0	5.0	2.5	0.40	1.49	0.82	0.402	0.196

[Note] 1) To the bearings with supplementary code "J" attached at the front of bearing number, tolerances shown in table 7-8 on page A72 are applied.

[Remark] Inch series tapered roller bearings with bore diameter larger than 100 mm are shown in catalog "large size ball & roller bearings".

Single-row tapered roller bearings
inch series

d (60.000) ~ (65.000) mm

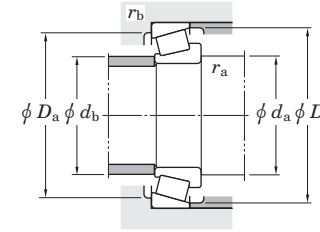
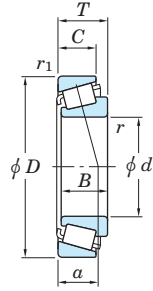

Boundary dimensions (mm)							Basic load ratings (kN)		Fatigue load limit	Limiting speeds (min ⁻¹)		Bearing No. ¹⁾	Load center (mm)	Mounting dimensions (mm)						Constant	Axial load factors		(Refer.) Mass (kg)		
d	D	T	B	C	$r_{min.}$	$r_{1 min.}$	C_r	C_{0r}	(kN) C_u	Grease lub.	Oil lub.			Inner ring	Outer ring	d_a	d_b	D_a	D_b		$r_{a max.}$	$r_{b max.}$	e	Y_1	Y_0
60.000	107.950	25.400	25.400	19.050	3.6	3.2	116	143	21.6	3 400	4 500	29580	29520	24.7	74.0	68.0	96.0	103.0	3.6	3.2	0.46	1.31	0.72	0.713	0.277
	110.000	22.000	21.996	18.824	0.8	1.2	109	116	17.7	3 400	4 500			397	394A	21.3	69.0	68.0	101.0	104.5	0.8	1.2	0.40	1.49	0.82
60.325	100.000	25.400	25.400	19.845	3.6	3.2	115	137	20.6	3 700	4 900	28985	28921	22.8	73.0	67.0	89.0	96.0	3.6	3.2	0.43	1.41	0.78	0.533	0.230
	101.600	25.400	25.400	19.845	3.6	3.2	115	137	20.6	3 700	4 900	28985	28920	22.8	73.0	67.0	89.0	96.0	3.6	3.2	0.43	1.41	0.78	0.533	0.269
	122.238	43.658	43.764	36.512	3.6	3.2	276	318	43.6	3 200	4 300	5583R	5535	31.1	78.0	72.0	106.0	116.0	3.6	3.2	0.36	1.67	0.92	1.66	0.807
	127.000	36.512	36.512	26.988	3.6	1.6	209	235	36.2	3 000	4 000	HM813841	HM813811	32.9	80.0	73.0	113.0	121.0	3.6	1.6	0.50	1.20	0.66	1.60	0.622
	127.000	36.512	36.512	26.988	1.6	3.2	209	235	36.2	3 000	4 000	HM813841A	HM813810	32.9	74.0	71.0	110.0	121.0	1.6	3.2	0.50	1.20	0.66	1.62	0.606
	127.000	44.450	44.450	34.925	3.6	3.2	259	269	41.0	3 300	4 400	65237	65500	35.2	82.0	71.0	107.0	119.0	3.6	3.2	0.49	1.23	0.68	1.59	1.02
	127.000	44.450	44.450	34.925	1.6	3.2	259	269	41.0	3 300	4 400	65237A	65500	35.2	78.0	71.0	107.0	119.0	1.6	3.2	0.49	1.23	0.68	1.59	1.02
	136.525	46.038	46.038	36.512	3.6	3.2	290	369	49.6	2 800	3 700	H715332	H715311	37.0	84.0	78.0	118.0	132.0	3.6	3.2	0.47	1.27	0.70	2.56	0.950
61.912	110.000	22.000	21.996	18.824	0.8	1.2	109	116	17.7	3 400	4 500	392	394A	21.3	70.0	69.0	101.0	104.5	0.8	1.2	0.40	1.49	0.82	0.606	0.259
63.500	107.950	25.400	25.400	19.050	1.6	3.2	116	143	21.6	3 400	4 500	29586	29520	24.7	73.0	71.0	96.0	103.0	1.6	3.2	0.46	1.31	0.72	0.649	0.277
	110.000	22.000	21.996	18.824	1.6	1.2	109	116	17.7	3 400	4 500	390A	394A	21.3	73.0	70.0	101.0	104.5	1.6	1.2	0.40	1.49	0.82	0.579	0.259
	110.000	22.000	21.996	18.824	3.6	1.2	109	116	17.7	3 400	4 500	395	394A	21.3	77.0	70.0	101.0	104.5	3.6	1.2	0.40	1.49	0.82	0.575	0.259
	110.000	25.400	25.400	19.050	3.6	1.2	116	143	21.6	3 400	4 500	29585	29521	24.7	77.0	71.0	99.0	104.0	3.6	1.2	0.46	1.31	0.72	0.644	0.333
	112.712	30.162	30.162	23.812	3.6	3.2	184	207	32.1	3 300	4 500	39585	39520	23.3	77.0	71.0	101.0	107.0	3.6	3.2	0.34	1.77	0.97	0.908	0.355
	120.000	29.794	29.007	24.237	0.8	2.0	148	161	25.0	3 200	4 200	477	472	25.7	73.0	72.0	108.0	113.0	0.8	2.0	0.38	1.56	0.86	0.967	0.493
	122.238	38.354	38.100	29.718	3.6	3.2	238	249	39.1	3 200	4 300	HM212046	HM212011	27.6	80.0	73.0	108.0	116.0	3.6	3.2	0.34	1.78	0.98	1.36	0.591
	122.238	43.658	43.764	36.512	3.6	3.2	276	318	43.6	3 200	4 300	5584R	5535	31.1	81.0	75.0	106.0	116.0	3.6	3.2	0.36	1.67	0.92	1.56	0.807
	127.000	36.512	36.170	28.575	3.6	3.2	196	226	35.3	3 000	4 000	565	563	28.6	80.0	73.0	112.0	120.0	3.6	3.2	0.36	1.65	0.91	1.43	0.648
	135.755	53.975	56.007	44.450	4.3	3.2	333	357	49.3	3 000	4 000	6382	6320	34.8	84.0	77.0	117.0	126.0	4.3	3.2	0.32	1.85	1.02	2.29	1.39
	136.525	41.275	41.275	31.750	3.6	3.2	302	308	48.1	2 900	3 800	H414235	H414210	30.3	82.0	78.0	121.0	129.0	3.6	3.2	0.36	1.67	0.92	2.11	0.796
64.986	112.712	30.162	30.924	23.812	2.4	3.2	184	207	32.1	3 300	4 500	39586	39520	23.3	76.0	72.0	101.0	107.0	2.4	3.2	0.34	1.77	0.97	0.845	0.355
65.000	105.000	24.000	23.000	18.500	3.0	1.0	120	129	19.6	3 500	4 700	JLM710949	JLM710910	23.8	77.0	71.0	96.0	100.5	3.0	1.0	0.45	1.32	0.73	0.513	0.234
	110.000	28.000	28.000	22.500	3.0	2.8	170	191	29.4	3 400	4 600	JM511946	JM511910	24.5	78.0	72.0	99.0	105.0	3.0	2.8	0.40	1.49	0.82	0.733	0.338

[Note] 1) To the bearings with supplementary code "J" attached at the front of bearing number, tolerances shown in table 7-8 on page A72 are applied.

[Remark] Inch series tapered roller bearings with bore diameter larger than 100 mm are shown in catalog "large size ball & roller bearings".

Single-row tapered roller bearings inch series

d (65.000) ~ 68.262 mm

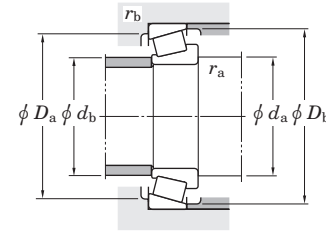
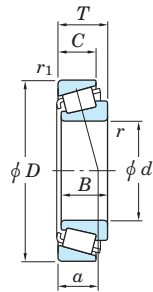

Boundary dimensions (mm)							Basic load ratings (kN)		Fatigue load limit (kN)	Limiting speeds (min ⁻¹)		Load center (mm)	Mounting dimensions (mm)						Constant e	Axial load factors		(Refer.) Mass (kg)					
d	D	T	B	C	r_{\min}	$r_{1\min}$	C_r	C_{0r}	C_u	Grease lub.	Oil lub.		a	d_a	d_b	D_a	D_b	$r_{a\max}$		$r_{b\max}$	Y_1	Y_0	Inner ring	Outer ring			
65.000	120.000	39.000	38.500	32.000	3.0	2.8	236	255	39.7	3 200	4 300		JH211749	JH211710	27.9	80.0	74.0	107.0	114.0	3.0	2.8	0.34	1.78	0.98	1.27	0.618	
	120.000	39.000	38.500	32.000	7.1	2.8	236	255	39.7	3 200	4 300		JH211749A	JH211710	27.9	88.0	74.0	107.0	114.0	7.1	2.8	0.34	1.78	0.98	1.27	0.618	
65.088	135.755	53.975	56.007	44.450	3.6	3.2	333	357	49.3	3 000	4 000		6379	6320	34.8	84.0	77.5	117.0	126.0	3.6	3.2	0.32	1.85	1.02	2.34	1.37	
	136.525	46.038	46.038	36.512	3.6	3.2	290	369	49.6	2 800	3 700		H715340	H715311	37.0	88.0	82.0	118.0	132.0	3.6	3.2	0.47	1.27	0.70	2.39	0.950	
65.883	122.238	43.658	43.764	36.512	3.6	3.2	276	318	43.6	3 200	4 300		5595R	5535	31.1	83.0	77.0	106.0	116.0	3.6	3.2	0.36	1.67	0.92	1.48	0.807	
66.675	110.000	22.000	21.996	18.824	0.8	1.2	109	116	17.7	3 400	4 500		395A	394A	21.3	73.0	73.0	101.0	104.5	0.8	1.2	0.40	1.49	0.82	0.524	0.259	
	110.000	22.000	21.996	18.824	3.6	1.2	109	116	17.7	3 400	4 500		395S	394A	21.3	79.0	73.0	101.0	104.5	3.6	1.2	0.40	1.49	0.82	0.519	0.259	
	112.712	30.162	30.048	23.812	3.6	0.8	139	164	25.1	3 400	4 500		3984	3925	25.9	80.0	74.0	101.0	106.0	3.6	0.8	0.40	1.49	0.82	0.700	0.454	
	112.712	30.162	30.162	23.812	3.6	3.2	184	207	32.1	3 300	4 500		39590	39520	23.3	80.0	74.0	101.0	107.0	3.6	3.2	0.34	1.77	0.97	0.832	0.355	
	112.712	30.162	30.162	23.812	3.6	0.8	184	207	32.1	3 300	4 500		39590	39521	23.3	80.0	74.0	103.0	107.0	3.6	0.8	0.34	1.77	0.97	0.832	0.360	
	117.475	30.162	30.162	23.812	3.6	3.2	148	179	27.4	3 200	4 200		33262	33462	27.8	81.0	75.0	104.0	112.0	3.6	3.2	0.44	1.38	0.76	0.910	0.436	
	122.238	38.100	38.354	29.718	3.6	1.6	238	249	39.1	3 200	4 300		HM212049	HM212010	27.3	82.0	75.5	110.0	116.0	3.6	1.6	0.34	1.78	0.98	1.26	0.596	
	127.000	36.512	36.512	26.988	3.6	1.6	209	235	36.2	3 000	4 000		HM813844	HM813811	32.9	85.0	78.0	113.0	121.0	3.6	1.6	0.50	1.20	0.66	1.42	0.622	
	130.175	41.275	41.275	31.750	3.6	3.2	246	267	41.8	3 000	3 900		641	633	30.3	83.0	77.0	116.0	124.0	3.6	3.2	0.36	1.66	0.91	1.68	0.703	
	135.755	53.975	56.007	44.450	4.3	3.2	333	357	49.3	3 000	4 000		6386	6320	34.8	87.0	77.5	117.0	126.0	4.3	3.2	0.32	1.85	1.02	2.27	1.37	
	135.755	53.975	56.007	44.450	6.4	3.2	333	357	49.3	3 000	4 000		6389	6320	34.8	91.0	77.5	117.0	126.0	6.4	3.2	0.32	1.85	1.02	2.15	1.37	
	136.525	41.275	41.275	31.750	3.6	3.2	302	308	48.1	2 900	3 800		H414242	H414210	30.3	85.0	81.0	121.0	129.0	3.6	3.2	0.36	1.67	0.92	2.01	0.796	
	136.525	46.038	46.038	36.512	3.6	3.2	290	369	49.6	2 800	3 700		H715341	H715311	37.0	89.0	83.0	118.0	132.0	3.6	3.2	0.47	1.27	0.70	2.33	0.950	
	68.262	110.000	22.000	21.996	18.824	2.4	1.2	109	116	17.7	3 400	4 500		399A	394A	21.3	78.0	74.0	101.0	104.5	2.4	1.2	0.40	1.49	0.82	0.493	0.259
		110.000	22.000	21.996	18.824	5.2	1.2	109	116	17.7	3 400	4 500		399AS	394A	21.3	83.0	74.0	101.0	104.5	5.2	1.2	0.40	1.49	0.82	0.485	0.259
117.475		30.162	30.162	23.812	3.6	3.2	148	179	27.4	3 200	4 200		33269	33462	27.8	82.0	76.0	104.0	112.0	3.6	3.2	0.44	1.38	0.76	0.870	0.436	
127.000		36.512	36.170	28.575	3.6	3.2	196	226	35.3	3 000	4 000		570	563	28.6	83.0	77.0	112.0	120.0	3.6	3.2	0.36	1.65	0.91	1.29	0.648	
136.525		41.275	41.275	31.750	3.6	3.2	284	308	46.1	2 900	3 800		H414245	H414210	30.3	86.0	82.0	121.0	129.0	3.6	3.2	0.36	1.67	0.92	1.92	0.788	
136.525		46.038	46.038	36.512	3.6	3.2	290	369	49.6	2 800	3 700		H715343	H715311	37.0	90.0	84.0	118.0	132.0	3.6	3.2	0.47	1.27	0.70	2.27	0.950	
152.400		47.625	46.038	31.750	3.6	3.2	306	278	38.3	2 700	3 600		9185	9121	44.5	94.0	81.5	130.0	145.0	3.6	3.2	0.66	0.91	0.50	2.67	1.20	

[Note] 1) To the bearings with supplementary code "J" attached at the front of bearing number, tolerances shown in table 7-8 on page A72 are applied.

[Remark] Inch series tapered roller bearings with bore diameter larger than 100 mm are shown in catalog "large size ball & roller bearings".

Single-row tapered roller bearings
inch series

d 69.850 ~ (73.025) mm

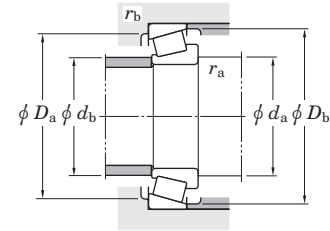
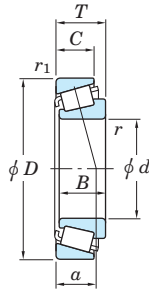

Boundary dimensions (mm)							Basic load ratings (kN)		Fatigue load limit	Limiting speeds (min ⁻¹)		Bearing No. ¹⁾	Load center (mm)	Mounting dimensions (mm)					Constant e	Axial load factors		(Refer.) Mass (kg)			
<i>d</i>	<i>D</i>	<i>T</i>	<i>B</i>	<i>C</i>	<i>r</i> _{min.}	<i>r</i> _{1 min.}	<i>C</i> _r	<i>C</i> _{0r}	(kN) <i>C</i> _u	Grease lub.	Oil lub.			Inner ring	Outer ring	<i>d</i> _a	<i>d</i> _b	<i>D</i> _a		<i>D</i> _b	<i>r</i> _{a max.}	<i>r</i> _{b max.}	<i>Y</i> ₁	<i>Y</i> ₀	Inner ring
69.850	98.425	13.495	13.495	9.525	1.6	1.6	49.1	59.8	8.45	3 500	4 700	LL713049	LL713010	18.4	77.0	74.0	92.0	94.5	1.6	1.6	0.44	1.37	0.75	0.205	0.086
	112.712	22.225	21.996	15.875	1.6	0.8	115	127	19.4	3 300	4 400	LM613449	LM613410	21.9	78.0	76.0	104.0	107.0	1.6	0.8	0.42	1.44	0.79	0.562	0.238
	112.712	25.400	25.400	19.050	1.6	3.2	122	155	23.3	3 200	4 300	29675	29620	26.2	80.0	77.0	101.0	109.0	1.6	3.2	0.49	1.23	0.68	0.676	0.270
	117.475	30.162	30.162	23.812	3.6	3.2	148	179	27.4	3 200	4 200	33275	33462	27.8	84.0	77.0	104.0	112.0	3.6	3.2	0.44	1.38	0.76	0.830	0.436
	120.000	29.002	29.007	23.444	3.6	3.2	148	161	25.0	3 200	4 200	482	472A	24.9	83.0	77.0	106.0	114.0	3.6	3.2	0.38	1.56	0.86	0.791	0.462
	120.000	29.794	29.007	24.237	3.6	2.0	148	161	25.0	3 200	4 200	482	472	25.7	83.0	77.0	108.0	113.0	3.6	2.0	0.38	1.56	0.86	0.791	0.487
	120.000	32.545	32.545	26.195	3.6	3.2	189	218	33.9	3 100	4 200	47487R	47420	26.6	84.0	78.0	107.0	114.0	3.6	3.2	0.36	1.67	0.92	1.01	0.476
	120.650	32.545	32.545	26.195	3.6	0.8	189	218	33.9	3 100	4 200	47487R	47423	26.6	84.0	78.0	109.0	114.0	3.6	0.8	0.36	1.67	0.92	1.01	0.513
	123.825	30.162	29.007	24.605	3.6	3.2	148	161	25.0	3 200	4 200	482	472X	26.0	83.0	77.0	109.0	114.0	3.6	3.2	0.38	1.56	0.86	0.791	0.625
	127.000	36.512	36.170	28.575	3.6	3.2	196	226	35.3	3 000	4 000	566	563	28.6	85.0	78.0	112.0	120.0	3.6	3.2	0.36	1.65	0.91	1.24	0.648
146.050	41.275	41.275	31.750	3.6	3.2	261	301	45.3	2 600	3 400	655	653	33.4	88.0	82.0	131.0	139.0	3.6	3.2	0.41	1.47	0.81	2.35	0.891	
150.089	44.450	46.672	36.512	3.6	3.2	330	368	50.1	2 500	3 400	745AR	742	32.4	88.0	82.0	134.0	142.0	3.6	3.2	0.33	1.84	1.01	2.79	1.07	
168.275	53.975	56.363	41.275	3.6	3.2	429	467	62.1	2 300	3 100	835R	832	35.0	91.0	84.0	149.0	155.0	3.6	3.2	0.30	2.00	1.10	4.32	1.72	
69.952	121.442	24.608	23.012	17.462	2.0	2.0	113	127	19.4	3 000	4 000	34274	34478	26.8	81.0	78.0	110.0	116.0	2.0	2.0	0.45	1.33	0.73	0.764	0.316
	110.000	26.000	25.000	20.500	1.0	2.5	129	158	23.9	3 300	4 400	JLM813049	JLM813010	26.1	78.0	77.0	98.0	105.0	1.0	2.5	0.49	1.23	0.68	0.590	0.300
70.000	115.000	29.000	29.000	23.000	3.0	2.5	155	173	26.6	3 200	4 300	JM612949	JM612910	26.2	83.0	77.0	103.0	110.0	3.0	2.5	0.43	1.39	0.77	0.776	0.358
	117.475	30.162	30.162	23.812	3.6	3.2	148	179	27.4	3 200	4 200	33281	33462	27.8	85.0	79.0	104.0	112.0	3.6	3.2	0.44	1.38	0.76	0.789	0.436
71.438	120.000	32.545	32.545	26.195	3.6	3.2	189	218	33.9	3 100	4 200	47490R	47420	26.6	86.0	79.0	107.0	114.0	3.6	3.2	0.36	1.67	0.92	0.964	0.476
	127.000	36.512	36.170	28.575	3.6	3.2	196	226	35.3	3 000	4 000	567A	563	28.6	86.0	80.0	112.0	120.0	3.6	3.2	0.36	1.65	0.91	1.19	0.648
	127.000	36.512	36.512	26.988	3.6	1.6	209	235	36.2	3 000	4 000	HM813849	HM813811	32.9	89.0	81.9	113.0	121.0	3.6	1.6	0.50	1.20	0.66	1.28	0.622
	136.525	41.275	41.275	31.750	3.6	3.2	284	308	46.1	2 900	3 800	H414249	H414210	30.3	89.0	83.3	121.0	129.0	3.6	3.2	0.36	1.67	0.92	1.80	0.788
	136.525	46.038	46.038	36.512	3.6	3.2	290	369	49.6	2 800	3 700	H715345	H715311	37.0	93.0	87.0	118.0	132.0	3.6	3.2	0.47	1.27	0.70	2.15	0.950
	112.712	25.400	25.400	19.050	3.6	3.2	122	155	23.3	3 200	4 300	29685	29620	26.2	86.0	80.0	101.0	109.0	3.6	3.2	0.49	1.23	0.68	0.602	0.270
	117.475	30.162	30.162	23.812	3.6	3.2	148	179	27.4	3 200	4 200	33287	33462	27.8	87.0	80.0	104.0	112.0	3.6	3.2	0.44	1.38	0.76	0.747	0.436
	127.000	36.512	36.170	28.575	3.6	3.2	196	226	35.3	3 000	4 000	567	563	28.6	88.0	81.0	112.0	120.0	3.6	3.2	0.36	1.65	0.91	1.14	0.648
139.992	36.512	36.098	28.575	3.6	3.2	220	262	39.8	2 700	3 600	576R	572	31.0	90.0	83.0	125.0	133.0	3.6	3.2	0.40	1.49	0.82	1.74	0.779	

[Note] 1) To the bearings with supplementary code "J" attached at the front of bearing number, tolerances shown in table 7-8 on page A72 are applied.

[Remark] Inch series tapered roller bearings with bore diameter larger than 100 mm are shown in catalog "large size ball & roller bearings".

Single-row tapered roller bearings
inch series

d (73.025) ~ 76.200 mm

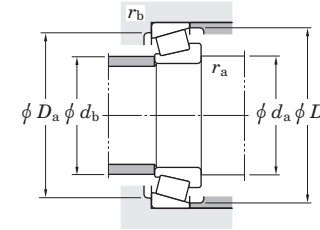
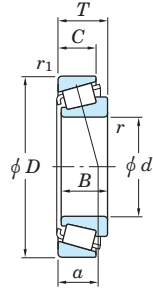

Boundary dimensions (mm)							Basic load ratings (kN)		Fatigue load limit (kN) C_u	Limiting speeds (min^{-1})		Bearing No. ¹⁾	Load center (mm) a	Mounting dimensions (mm)						Constant e	Axial load factors		(Refer.) Mass (kg)		
d	D	T	B	C	r_{min}	r_1_{min}	C_r	C_{0r}		Grease lub.	Oil lub.			Inner ring	Outer ring	d_a	d_b	D_a	D_b		$r_{a \text{ max}}$	$r_{b \text{ max}}$	Y_1	Y_0	Inner ring
73.025	146.050	41.275	41.275	31.750	3.6	3.2	261	301	45.3	2 600	3 400	657	653	33.4	90.0	85.0	131.0	139.0	3.6	3.2	0.41	1.47	0.81	2.28	0.880
	149.225	53.975	54.229	44.450	3.6	3.2	357	404	54.4	2 700	3 500	6460	6420	39.3	93.0	87.0	129.0	141.0	3.6	3.2	0.36	1.66	0.91	2.79	1.61
	150.089	44.450	46.672	36.512	3.6	3.2	330	368	50.1	2 500	3 400	744R	742	32.4	91.0	85.0	134.0	142.0	3.6	3.2	0.33	1.84	1.01	2.66	1.07
	161.925	47.625	48.260	38.100	3.6	3.2	342	391	52.4	2 400	3 200	762	752	35.5	92.0	97.0	144.0	150.0	3.6	3.2	0.34	1.76	0.97	3.18	1.61
73.817	112.712	25.400	25.400	19.050	1.6	3.2	122	155	23.3	3 200	4 300	29688	29620	26.2	83.0	81.0	101.0	109.0	1.6	3.2	0.49	1.23	0.68	0.588	0.270
	127.000	36.512	36.170	28.575	0.8	3.2	196	226	35.3	3 000	4 000	568	563	28.6	83.0	82.0	112.0	120.0	0.8	3.2	0.36	1.65	0.91	1.12	0.648
74.612	139.992	36.512	36.098	28.575	3.6	3.2	220	262	39.8	2 700	3 600	577R	572	31.0	91.0	85.0	125.0	133.0	3.6	3.2	0.40	1.49	0.82	1.69	0.779
75.000	115.000	25.000	25.000	19.000	3.0	2.8	127	151	23.0	3 100	4 200	JLM714149	JLM714110	25.5	87.0	81.0	104.0	110.0	3.0	2.8	0.46	1.31	0.72	0.612	0.269
	120.000	31.000	29.500	25.000	3.0	2.8	182	216	33.2	3 100	4 100	JM714249	JM714210	30.0	88.0	82.9	108.0	115.0	3.0	2.8	0.44	1.35	0.74	0.846	0.430
	145.000	51.000	51.000	42.000	3.0	2.5	362	412	55.2	2 700	3 600	JH415647	JH415610	36.6	94.0	89.0	129.0	139.0	3.0	2.5	0.36	1.66	0.91	2.66	1.18
76.200	121.442	24.608	23.012	17.462	3.6	2.0	113	127	19.4	3 000	4 000	34301	34478	26.8	89.0	83.0	110.0	116.0	3.6	2.0	0.45	1.33	0.73	0.617	0.313
	127.000	30.162	31.000	22.225	3.6	3.2	179	225	32.3	2 400	3 200	42687	42620	27.1	90.0	84.0	114.0	121.0	3.6	3.2	0.42	1.43	0.79	1.05	0.434
	127.000	30.162	31.000	22.225	6.4	3.2	179	225	32.3	2 400	3 200	42688	42620	27.1	96.0	84.0	114.0	121.0	6.4	3.2	0.42	1.43	0.79	1.04	0.434
	133.350	30.162	29.769	22.225	6.4	3.2	167	198	30.0	2 700	3 600	495AX	492A	29.8	98.0	86.0	120.0	128.0	6.4	3.2	0.44	1.35	0.74	1.20	0.430
	133.350	33.338	33.338	26.195	6.4	3.2	193	245	37.2	2 700	3 700	47678R	47620	29.2	97.0	90.0	119.0	128.0	6.4	3.2	0.40	1.48	0.82	1.29	0.577
	133.350	33.338	33.338	26.195	0.8	3.2	193	245	37.2	2 700	3 700	47680R	47620	29.2	86.0	85.0	119.0	128.0	0.8	3.2	0.40	1.48	0.82	1.39	0.577
	135.733	44.450	46.101	34.925	3.6	3.2	267	337	51.0	2 800	3 700	5760	5735	33.0	94.0	88.0	119.0	130.0	3.6	3.2	0.41	1.48	0.81	1.85	0.877
	136.525	30.162	29.769	22.225	3.6	3.2	167	198	30.0	2 700	3 600	495A	493	29.8	92.0	86.0	122.0	130.0	3.6	3.2	0.44	1.35	0.74	1.26	0.544
	139.992	36.512	36.098	28.575	3.6	3.2	220	262	39.8	2 700	3 600	575R	572	31.0	92.0	86.0	125.0	133.0	3.6	3.2	0.40	1.49	0.82	1.64	0.779
	139.992	36.512	36.098	28.575	6.7	3.2	220	262	39.8	2 700	3 600	575SR	572	31.0	99.0	86.0	125.0	133.0	6.7	3.2	0.40	1.49	0.82	1.61	0.779
	149.225	53.975	54.229	44.450	3.6	3.2	357	404	54.4	2 700	3 500	6461	6420	39.3	96.0	89.5	129.0	141.0	3.6	3.2	0.36	1.66	0.91	2.64	1.61
	149.225	53.975	54.229	44.450	9.5	3.2	357	404	54.4	2 700	3 500	6461A	6420	39.3	105.0	90.0	129.0	141.0	9.5	3.2	0.36	1.66	0.91	2.60	1.61
	150.089	44.450	46.672	36.512	3.6	3.2	330	368	50.1	2 500	3 400	748SR	742	32.4	93.0	87.0	134.0	142.0	3.6	3.2	0.33	1.84	1.01	2.51	1.06
	152.400	41.275	41.275	31.750	3.6	3.2	261	301	45.3	2 600	3 400	659	652	33.4	93.0	87.0	134.0	141.0	3.6	3.2	0.41	1.47	0.81	2.16	1.25
	190.500	57.150	57.531	46.038	3.6	3.2	549	602	76.9	2 000	2 700	HH221430	HH221410	42.5	101.0	95.0	171.0	179.0	3.6	3.2	0.33	1.79	0.99	6.33	2.21

[Note] 1) To the bearings with supplementary code "J" attached at the front of bearing number, tolerances shown in table 7-8 on page A72 are applied.

[Remark] Inch series tapered roller bearings with bore diameter larger than 100 mm are shown in catalog "large size ball & roller bearings".

Single-row tapered roller bearings
inch series

d 77.788 ~ (83.345) mm

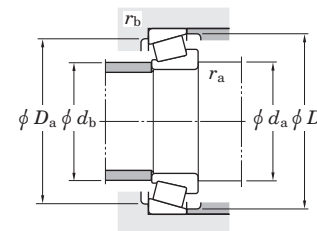
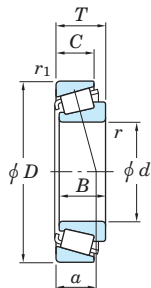

Boundary dimensions (mm)						Basic load ratings (kN)		Fatigue load limit (kN)	Limiting speeds (min ⁻¹)		Bearing No. ¹⁾	Load center (mm)	Mounting dimensions (mm)						Constant e	Axial load factors		(Refer.) Mass (kg)			
d	D	T	B	C	$r_{min.}$	$r1_{min.}$	C_r	C_{0r}	C_u	Grease lub.			Oil lub.	Inner ring	Outer ring	d_a	d_b	D_a		D_b	$r_{a,max.}$	$r_{b,max.}$	Y_1	Y_0	Inner ring
77.788	117.475	25.400	25.400	19.050	3.6	3.2	127	166	25.1	3 100	4 100	LM814849	LM814810	27.6	91.0	85.0	105.0	113.0	3.6	3.2	0.51	1.18	0.65	0.619	0.295
	121.442	24.608	23.012	17.462	3.6	2.0	113	127	19.4	3 000	4 000	34306	34478	26.8	90.0	84.0	110.0	116.0	3.6	2.0	0.45	1.33	0.73	0.583	0.313
	121.442	24.608	23.012	17.462	6.4	2.0	113	127	19.4	3 000	4 000	34307	34478	26.8	96.0	84.0	110.0	116.0	6.4	2.0	0.45	1.33	0.73	0.571	0.313
	127.000	30.162	31.000	22.225	3.6	3.2	179	225	32.3	2 400	3 200	42690	42620	27.1	91.0	85.0	114.0	121.0	3.6	3.2	0.42	1.43	0.79	1.00	0.434
79.375	146.050	41.275	41.275	31.750	3.6	3.2	261	301	45.3	2 600	3 400	661	653	33.4	96.0	90.0	131.0	139.0	3.6	3.2	0.41	1.47	0.81	2.04	0.880
	161.925	47.625	48.260	38.100	7.9	3.2	342	391	52.4	2 400	3 200	756A	752	35.5	106.0	91.0	144.0	150.0	7.9	3.2	0.34	1.76	0.97	2.95	1.59
	190.500	57.150	57.531	46.038	3.6	3.2	549	602	76.9	2 000	2 700	HH221431	HH221410	42.5	103.0	97.0	171.0	179.0	3.6	3.2	0.33	1.79	0.99	6.16	2.21
80.000	130.000	35.000	34.000	28.500	3.2	2.5	211	256	39.3	2 800	3 800	JM515649	JM515610	29.6	94.0	88.0	117.0	125.0	3.2	2.5	0.39	1.54	0.85	1.19	0.575
	200.000	52.761	49.212	34.925	3.6	3.2	433	471	58.8	1 400	1 900	98316	98788	54.5	111.0	105.0	174.0	188.0	3.6	3.2	0.63	0.95	0.52	5.73	2.28
80.962	133.350	30.162	29.769	22.225	3.6	3.2	167	198	30.0	2 700	3 600	496	492A	29.8	95.0	89.0	120.0	128.0	3.6	3.2	0.44	1.35	0.74	1.12	0.429
	133.350	33.338	33.338	26.195	3.6	3.2	193	245	37.2	2 700	3 700	47681R	47620	29.2	95.0	89.0	119.0	128.0	3.6	3.2	0.40	1.48	0.82	1.17	0.577
	139.992	36.512	36.098	28.575	3.6	3.2	220	262	39.8	2 700	3 600	581R	572	31.0	96.0	90.0	125.0	133.0	3.6	3.2	0.40	1.49	0.82	1.47	0.779
	150.089	44.450	46.672	36.512	5.2	3.2	330	368	50.1	2 500	3 400	740R	742	32.4	101.0	91.0	134.0	142.0	5.2	3.2	0.33	1.84	1.01	2.30	1.06
82.550	125.412	25.400	25.400	19.845	3.6	1.6	126	162	24.4	2 900	3 800	27687	27620	24.7	96.0	89.0	115.0	120.0	3.6	1.6	0.42	1.44	0.79	0.710	0.344
	133.350	30.162	29.769	22.225	3.6	3.2	167	198	30.0	2 700	3 600	495	492A	29.8	97.0	90.0	120.0	128.0	3.6	3.2	0.44	1.35	0.74	1.08	0.429
	133.350	33.338	33.338	26.195	3.6	0.8	193	245	37.2	2 700	3 700	47686R	47620A	29.2	97.0	90.0	121.0	128.0	3.6	0.8	0.40	1.48	0.82	1.13	0.577
	133.350	39.688	39.688	32.545	6.7	3.2	222	306	45.9	2 800	3 700	HM516448	HM516410	32.2	105.0	92.0	118.0	128.0	6.7	3.2	0.40	1.49	0.82	1.33	0.763
	139.700	36.512	36.098	28.575	3.6	3.2	220	262	39.8	2 700	3 600	580R	572X	31.0	98.0	91.0	125.0	133.0	3.6	3.2	0.40	1.49	0.82	1.41	0.765
	139.992	36.512	36.098	28.575	3.6	3.2	220	262	39.8	2 700	3 600	580R	572	31.0	98.0	91.0	125.0	133.0	3.6	3.2	0.40	1.49	0.82	1.41	0.779
	139.992	36.512	36.098	28.575	6.7	3.2	220	262	39.8	2 700	3 600	582R	572	31.0	104.0	91.0	125.0	133.0	6.7	3.2	0.40	1.49	0.82	1.40	0.779
	146.050	41.275	41.275	31.750	3.6	3.2	261	301	45.3	2 600	3 400	663	653	33.4	99.0	92.0	131.0	139.0	3.6	3.2	0.41	1.47	0.81	1.91	0.880
	150.089	44.450	46.672	36.512	3.6	3.2	330	368	50.1	2 500	3 400	749AR	742	32.4	99.0	93.0	134.0	142.0	3.6	3.2	0.33	1.84	1.01	2.23	1.06
	150.089	44.450	46.672	36.512	6.7	3.2	330	368	50.1	2 500	3 400	750AR	742	32.4	106.0	93.0	134.0	142.0	6.7	3.2	0.33	1.84	1.01	2.19	1.06
	161.925	47.625	48.260	38.100	3.6	3.2	342	391	52.4	2 400	3 200	757	752	35.5	100.0	94.0	144.0	150.0	3.6	3.2	0.34	1.76	0.97	2.83	1.59
83.345	125.412	25.400	25.400	19.845	0.8	1.6	126	162	24.4	2 900	3 800	27689	27620	24.7	90.0	90.0	115.0	120.0	0.8	1.6	0.42	1.44	0.79	0.746	0.344

[Note] 1) To the bearings with supplementary code "J" attached at the front of bearing number, tolerances shown in table 7-8 on page A72 are applied.

[Remark] Inch series tapered roller bearings with bore diameter larger than 100 mm are shown in catalog "large size ball & roller bearings".

Single-row tapered roller bearings
inch series

d (83.345) ~ (88.900) mm

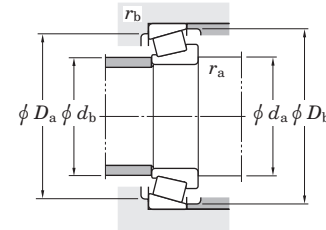
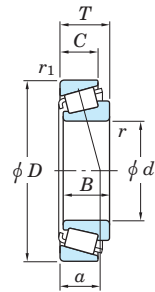

Boundary dimensions (mm)							Basic load ratings (kN)		Fatigue load limit (kN) <i>C_u</i>	Limiting speeds (min ⁻¹)		Bearing No. ¹⁾	Load center (mm) <i>a</i>	Mounting dimensions (mm)						Constant <i>e</i>	Axial load factors		(Refer.) Mass (kg)		
<i>d</i>	<i>D</i>	<i>T</i>	<i>B</i>	<i>C</i>	<i>r</i> _{min.}	<i>r</i> ₁ _{min.}	<i>C_r</i>	<i>C_{0r}</i>		Grease lub.	Oil lub.			Inner ring	Outer ring	<i>d_a</i>	<i>d_b</i>	<i>D_a</i>	<i>D_b</i>		<i>r_a</i> _{max.}	<i>r_b</i> _{max.}	<i>Y</i> ₁	<i>Y</i> ₀	Inner ring
83.345	125.412	25.400	25.400	19.845	3.6	1.6	126	162	24.4	2 900	3 800	27690	27620	24.7	96.0	90.0	115.0	120.0	3.6	1.6	0.42	1.44	0.79	0.689	0.344
	125.412	25.400	25.400	19.845	6.4	1.6	126	162	24.4	2 900	3 800	27691	27620	24.7	102.0	90.0	115.0	120.0	6.4	1.6	0.42	1.44	0.79	0.646	0.344
84.138	133.350	30.162	29.769	22.225	3.6	3.2	167	198	30.0	2 700	3 600	498	492A	29.8	98.0	91.0	120.0	128.0	3.6	3.2	0.44	1.35	0.74	1.04	0.429
85.000	130.000	30.000	29.000	24.000	3.0	2.5	179	228	34.5	2 800	3 700	JM716649	JM716610	29.1	98.0	92.0	117.0	125.0	3.0	2.5	0.44	1.35	0.74	0.937	0.456
	140.000	39.000	38.000	31.500	3.0	2.5	254	308	46.4	2 700	3 500	JHM516849	JHM516810	32.8	100.0	93.9	125.0	134.0	3.0	2.5	0.41	1.47	0.81	1.54	0.759
	150.000	46.000	46.000	38.000	3.0	2.5	342	390	53.1	2 500	3 400	JH217249	JH217210	33.6	101.0	95.2	134.0	142.0	3.0	2.5	0.33	1.80	0.99	2.28	1.08
	200.000	52.761	49.212	34.925	3.6	3.2	433	471	58.8	1 400	1 900	98335	98788	54.5	115.0	109.0	174.0	188.0	3.6	3.2	0.63	0.95	0.52	5.47	2.28
85.026	150.089	44.450	46.672	36.512	3.6	3.2	330	368	50.1	2 500	3 400	749R	742	32.4	101.0	95.0	134.0	142.0	3.6	3.2	0.33	1.84	1.01	2.12	1.06
	150.089	44.450	46.672	36.512	5.2	3.2	330	368	50.1	2 500	3 400	749SR	742	32.4	104.0	95.0	134.0	142.0	5.2	3.2	0.33	1.84	1.01	2.08	1.06
85.725	133.350	30.162	29.769	22.225	3.6	3.2	167	198	30.0	2 700	3 600	497	492A	29.8	99.0	93.0	120.0	128.0	3.6	3.2	0.44	1.35	0.74	0.978	0.429
	136.525	30.162	29.769	22.225	6.4	3.2	167	198	30.0	2 700	3 600	497A	493	29.8	105.0	93.0	122.0	130.0	6.4	3.2	0.44	1.35	0.74	0.965	0.544
	142.138	42.862	42.862	34.133	4.8	3.2	276	351	52.4	2 600	3 500	HM617049	HM617010	35.2	106.0	95.7	125.0	137.0	4.8	3.2	0.43	1.39	0.76	1.72	0.902
	146.050	41.275	41.275	31.750	3.6	3.2	261	301	45.3	2 600	3 400	665	653	33.4	102.0	95.0	131.0	139.0	3.6	3.2	0.41	1.47	0.81	1.77	0.880
	146.050	41.275	41.275	31.750	6.4	3.2	261	301	45.3	2 600	3 400	665A	653	33.4	107.0	95.0	131.0	139.0	6.4	3.2	0.41	1.47	0.81	1.76	0.880
	152.400	39.688	36.322	30.162	3.6	3.2	230	287	42.5	2 400	3 300	596	592A	37.1	102.0	96.0	135.0	144.0	3.6	3.2	0.44	1.36	0.75	1.83	1.04
	161.925	47.625	48.260	38.100	3.6	3.2	342	391	52.4	2 400	3 200	758	752	35.5	103.0	97.0	144.0	150.0	3.6	3.2	0.34	1.76	0.97	2.67	1.59
	168.275	41.275	41.275	30.162	3.6	3.2	282	349	50.4	2 200	3 000	677	672	38.6	105.0	99.0	149.0	160.0	3.6	3.2	0.47	1.28	0.70	2.89	1.22
	168.275	53.975	56.363	41.275	3.6	3.2	429	467	62.1	2 300	3 100	841R	832	35.0	104.0	97.0	149.0	155.0	3.6	3.2	0.30	2.00	1.10	3.47	1.72
	88.900	123.825	20.638	20.638	16.670	1.6	1.6	102	145	21.5	2 800	3 700	L217849	L217810	20.7	97.0	94.0	116.0	119.0	1.6	1.6	0.33	1.82	1.00	0.507
152.400		39.688	39.688	30.162	6.4	3.2	311	359	53.5	2 400	3 200	HM518445	HM518410	33.1	110.0	98.0	135.0	146.0	6.4	3.2	0.40	1.49	0.82	2.10	0.768
161.925		47.625	48.260	38.100	3.6	3.2	342	391	52.4	2 400	3 200	759	752	35.5	106.0	99.0	144.0	150.0	3.6	3.2	0.34	1.76	0.97	2.50	1.59
161.925		47.625	48.260	38.100	7.1	3.2	342	391	52.4	2 400	3 200	766	752	35.5	113.0	99.0	144.0	150.0	7.1	3.2	0.34	1.76	0.97	2.48	1.59
161.925		53.975	55.100	42.862	3.6	3.2	395	471	61.4	2 400	3 200	6580R	6535	49.8	109.0	98.0	141.0	154.0	3.6	3.2	0.40	1.50	0.82	3.09	1.65
168.275		41.275	41.275	30.162	3.6	3.2	282	349	50.4	2 200	3 000	679	672	38.6	107.0	101.0	149.0	160.0	3.6	3.2	0.47	1.28	0.70	2.75	1.22
190.500		57.150	57.531	44.450	7.9	3.2	482	565	72.4	2 100	2 700	855R	854	40.0	118.0	103.0	170.0	174.0	7.9	3.2	0.33	1.79	0.99	5.05	2.66

[Note] 1) To the bearings with supplementary code "J" attached at the front of bearing number, tolerances shown in table 7-8 on page A72 are applied.

[Remark] Inch series tapered roller bearings with bore diameter larger than 100 mm are shown in catalog "large size ball & roller bearings".

Single-row tapered roller bearings
inch series

d (88.900) ~ 99.975 mm

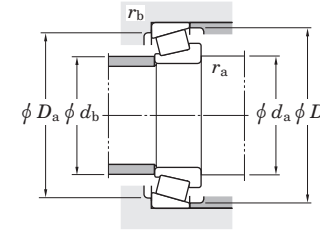
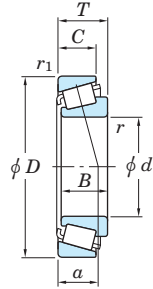

Boundary dimensions (mm)							Basic load ratings (kN)		Fatigue load limit (kN)	Limiting speeds (min ⁻¹)		Bearing No. ¹⁾	Load center (mm)	Mounting dimensions (mm)						Constant e	Axial load factors		(Refer.) Mass (kg)				
d	D	T	B	C	$r_{min.}$	$r_{1 min.}$	C_r	C_{0r}	C_u	Grease lub.	Oil lub.			Inner ring	Outer ring	d_a	d_b	D_a	D_b		$r_{a max.}$	$r_{b max.}$	Y_1	Y_0	Inner ring	Outer ring	
88.900	190.500	57.150	57.531	46.038	7.9	3.2	549	602	76.9	2 000	2 700	HH221434	HH221410	42.5	120.0	105.0	171.0	179.0	7.9	3.2	0.33	1.79	0.99	5.57	2.21		
	200.000	52.761	49.212	34.925	3.6	3.2	433	471	58.8	1 400	1 900			54.5	118.0	112.0	174.0	188.0	3.6	3.2	0.63	0.95	0.52	5.27	2.28		
89.974	146.975	40.000	40.000	32.500	7.1	3.6	259	310	46.6	2 500	3 300	HM218248	HM218210	30.8	112.0	99.0	133.0	141.0	7.1	3.6	0.33	1.80	0.99	1.66	0.784		
90.000	145.000	35.000	34.000	27.000	3.0	2.5	244	291	43.5	2 500	3 400	JM718149	JM718110	32.7	105.0	99.0	131.0	139.0	3.0	2.5	0.44	1.35	0.74	1.47	0.652		
	155.000	44.000	44.000	35.500	3.0	2.5	363	407	54.8	2 400	3 200			JHM318448	JHM318410	34.5	106.0	100.0	140.0	148.0	3.0	2.5	0.34	1.76	0.97	2.37	1.00
	161.925	53.975	55.100	42.862	3.0	3.2	395	471	61.4	2 400	3 200			6581XR	6535	41.0	102.0	98.0	141.0	154.0	3.0	3.2	0.40	1.50	0.82	3.02	1.65
90.488	161.925	47.625	48.260	38.100	3.6	3.2	342	391	52.4	2 400	3 200	760	752	35.5	107.0	101.0	144.0	150.0	3.6	3.2	0.34	1.76	0.97	2.42	1.59		
92.075	146.050	33.338	34.925	26.195	3.6	3.2	223	293	43.2	2 500	3 300	47890R	47820	32.6	107.0	101.0	131.0	140.0	3.6	3.2	0.45	1.34	0.74	1.46	0.657		
	168.275	41.275	41.275	30.162	3.6	3.2	282	349	50.4	2 200	3 000			681	672	38.6	110.0	104.0	149.0	160.0	3.6	3.2	0.47	1.28	0.70	2.61	1.22
	168.275	41.275	41.275	30.162	6.4	3.2	282	349	50.4	2 200	3 000			681A	672	38.6	116.0	104.0	149.0	160.0	6.4	3.2	0.47	1.28	0.70	2.60	1.22
	180.975	47.625	48.006	38.100	3.6	3.2	362	438	56.6	2 100	2 800			778	772	39.5	111.0	105.0	161.0	168.0	3.6	3.2	0.39	1.56	0.86	3.65	1.92
	190.500	57.150	57.531	44.450	7.9	3.2	482	565	72.4	2 100	2 700			857R	854	39.9	121.0	106.0	170.0	174.0	7.9	3.2	0.33	1.79	0.99	4.86	2.66
95.000	150.000	35.000	34.000	27.000	3.0	2.5	235	294	43.4	2 400	3 300	JM719149	JM719113	33.5	109.0	104.0	135.0	143.0	3.0	2.5	0.44	1.36	0.75	1.43	0.766		
95.250	128.588	15.875	15.083	11.908	1.6	1.6	72.6	93.0	13.1	2 600	3 500	LL319349	LL319310	20.3	103.0	100.0	122.0	125.0	1.6	1.6	0.35	1.71	0.94	0.393	0.147		
	130.175	20.638	21.432	16.670	1.6	1.6	121	167	24.7	2 600	3 500			L319249	L319210	22.2	107.0	101.0	122.0	125.0	1.6	1.6	0.35	1.72	0.95	0.548	0.246
	146.050	33.338	34.925	26.195	3.6	3.2	223	293	43.2	2 500	3 300			47896R	47820	32.6	110.0	103.0	131.0	140.0	3.6	3.2	0.45	1.34	0.74	1.34	0.657
	147.638	35.717	36.322	26.192	5.2	0.8	230	287	42.5	2 400	3 300			594A	592XE	33.4	113.0	104.0	135.0	142.0	5.2	0.8	0.44	1.36	0.75	1.45	0.620
	157.162	36.512	36.116	26.195	3.6	3.2	227	288	41.7	2 300	3 000			52375	52618	36.0	112.0	105.0	142.0	153.0	3.6	3.2	0.47	1.26	0.69	1.94	0.694
	168.275	41.275	41.275	30.162	3.6	3.2	282	349	50.4	2 200	3 000			683	672	38.6	113.0	106.0	149.0	160.0	3.6	3.2	0.47	1.28	0.70	2.46	1.22
	190.500	57.150	57.531	44.450	7.9	3.2	482	565	72.4	2 100	2 700			864R	854	39.9	123.0	108.0	170.0	174.0	7.9	3.2	0.33	1.79	0.99	4.64	2.66
	190.500	57.150	57.531	46.038	7.9	3.2	549	602	76.9	2 000	2 700			HH221440	HH221410	42.5	125.0	110.0	171.0	179.0	7.9	3.2	0.33	1.79	0.99	5.16	2.21
	98.425	168.275	41.275	41.275	30.162	3.6	3.2	282	349	50.4	2 200			3 000	685	672	38.6	116.0	109.0	149.0	160.0	3.6	3.2	0.47	1.28	0.70	2.29
190.500		57.150	57.531	46.038	3.6	3.2	549	602	76.9	2 000	2 700	HH221442	HH221410	42.5			119.0	113.0	171.0	179.0	3.6	3.2	0.33	1.79	0.99	4.97	2.21
99.975	212.725	66.675	66.675	53.975	3.6	3.2	641	699	87.1	1 800	2 400	HH224334	HH224310	47.6	122.0	117.0	192.0	202.0	3.6	3.2	0.33	1.84	1.01	7.91	3.03		

[Note] 1) To the bearings with supplementary code "J" attached at the front of bearing number, tolerances shown in table 7-8 on page A72 are applied.

[Remark] Inch series tapered roller bearings with bore diameter larger than 100 mm are shown in catalog "large size ball & roller bearings".

Single-row tapered roller bearings
inch series

d 99.982 ~ (107.950) mm

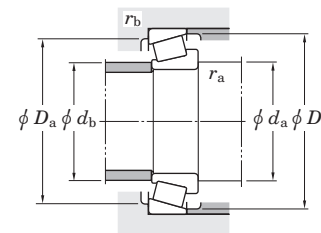
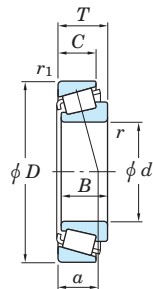

Boundary dimensions (mm)							Basic load ratings (kN)		Fatigue load limit (kN)	Limiting speeds (min ⁻¹)		Inner ring	Outer ring	Load center (mm) a	Mounting dimensions (mm)					Constant e	Axial load factors		(Refer.) Mass (kg)		
d	D	T	B	C	r _{min.}	r _{1 min.}	C _r	C _{0r}	C _u	Grease lub.	Oil lub.				d _a	d _b	D _a	D _b	r _{a max.}		r _{b max.}	Y ₁	Y ₀	Inner ring	Outer ring
99.982	190.500	57.150	57.531	46.038	6.4	3.2	549	602	76.9	2 000	2 700	HH221447	HH221410	42.5	126.0	114.0	171.0	179.0	6.4	3.2	0.33	1.79	0.99	4.84	2.21
100.000	155.000	36.000	35.000	28.000	3.0	2.5	256	328	47.7	2 300	3 100	JM720249	JM720210	35.6	110.0	110.0	139.0	148.0	3.0	2.5	0.47	1.27	0.70	1.64	0.763
	160.000	41.000	40.000	32.000	3.0	2.5	298	378	54.6	2 300	3 000	JHM720249	JHM720210	38.3	110.0	111.0	143.0	153.0	3.0	2.5	0.47	1.28	0.70	2.11	0.964
100.012	157.162	36.512	36.116	26.195	3.6	3.2	227	288	41.7	2 300	3 000	52393	52618	36.0	113.0	115.0	142.0	153.0	3.6	3.2	0.47	1.26	0.69	1.74	0.694
101.600	157.162	36.512	36.116	26.195	3.6	3.2	227	288	41.7	2 300	3 000	52400	52618	36.0	114.0	115.0	142.0	153.0	3.6	3.2	0.47	1.26	0.69	1.67	0.694
	157.162	36.512	36.116	26.195	7.9	3.2	227	288	41.7	2 300	3 000	52401	52618	36.0	126.0	111.0	142.0	153.0	7.9	3.2	0.47	1.26	0.69	1.64	0.694
	168.275	41.275	41.275	30.162	3.6	3.2	282	349	50.4	2 200	3 000	687	672	38.6	114.0	115.0	146.0	157.0	3.6	3.2	0.47	1.28	0.70	2.15	1.22
	180.975	47.625	48.006	38.100	3.6	3.2	362	438	56.6	2 100	2 800	780	772	39.5	114.0	120.0	156.0	165.0	3.6	3.2	0.39	1.56	0.86	3.09	1.92
	190.500	57.150	57.531	44.450	7.9	3.2	482	565	72.4	2 100	2 700	861R	854	39.9	129.0	114.0	170.0	174.0	7.9	3.2	0.33	1.79	0.99	4.20	2.66
	190.500	57.150	57.531	46.038	7.9	3.2	549	602	76.9	2 000	2 700	HH221449	HH221410	42.5	123.0	119.0	168.0	178.0	7.9	3.2	0.33	1.79	0.99	4.72	2.21
	200.000	52.761	49.212	34.925	3.6	3.2	433	471	58.8	1 400	1 900	98400	98788	54.5	114.0	123.0	170.0	185.0	3.6	3.2	0.63	0.95	0.52	4.55	2.28
	212.725	66.675	66.675	53.975	7.1	3.2	563	674	84.1	1 800	2 400	941	932	47.6	121.0	135.0	181.0	192.0	7.1	3.2	0.33	1.84	1.01	7.07	4.07
212.725	66.675	66.675	53.975	7.1	3.2	641	699	87.1	1 800	2 400	HH224335	HH224310	47.6	121.0	134.0	189.0	201.0	7.1	3.2	0.33	1.84	1.01	7.76	3.03	
104.775	180.975	47.625	48.006	38.100	3.6	3.2	362	438	56.6	2 100	2 800	782	772	39.5	117.0	120.0	156.0	165.0	3.6	3.2	0.39	1.56	0.86	2.90	1.92
	180.975	47.625	48.006	38.100	6.4	3.2	362	438	56.6	2 100	2 800	786	772	39.5	123.0	120.0	156.0	165.0	6.4	3.2	0.39	1.56	0.86	2.88	1.92
	180.975	47.625	48.006	38.100	7.1	3.2	362	438	56.6	2 100	2 800	787	772	39.5	129.0	116.0	161.0	168.0	7.1	3.2	0.39	1.56	0.86	2.87	1.92
	190.500	47.625	49.212	34.925	3.6	3.2	381	483	60.9	1 900	2 600	71412	71750	40.9	117.0	131.0	167.0	177.0	3.6	3.2	0.42	1.44	0.79	3.96	1.72
106.362	165.100	36.512	36.512	26.988	3.6	3.2	245	325	46.3	2 200	2 900	56418R	56650	38.6	122.0	116.0	149.0	159.0	3.6	3.2	0.50	1.21	0.66	1.84	0.852
107.950	146.050	21.432	21.432	16.670	1.6	1.6	108	167	23.5	2 300	3 100	L521949R	L521910	26.2	116.0	114.0	136.0	141.0	1.6	1.6	0.39	1.53	0.84	0.665	0.325
	158.750	23.020	21.438	15.875	3.6	3.2	130	169	23.9	2 200	3 000	37425	37625	36.5	121.0	121.0	141.0	148.0	3.6	3.2	0.61	0.99	0.54	0.893	0.484
	159.987	34.925	34.925	26.988	3.6	3.2	231	319	45.8	2 200	2 900	LM522546	LM522510	32.9	122.0	116.0	146.0	154.0	3.6	3.2	0.40	1.50	0.82	1.64	0.784
	161.925	34.925	34.925	26.988	3.6	3.2	216	293	41.8	2 200	2 900	48190	48120	39.1	121.0	120.0	145.0	154.0	3.6	3.2	0.51	1.19	0.65	1.57	0.820
	165.100	36.512	36.512	26.988	3.6	3.2	245	325	46.3	2 200	2 900	56425R	56650	38.6	123.0	117.0	149.0	159.0	3.6	3.2	0.50	1.21	0.66	1.76	0.852
	168.275	36.512	36.512	26.988	3.6	3.2	245	325	46.3	2 200	2 900	56425R	56662	38.6	123.0	117.0	150.0	160.0	3.6	3.2	0.50	1.21	0.66	1.76	1.03
	190.500	47.625	49.212	34.925	3.6	3.2	381	483	60.9	1 900	2 600	71425	71750	40.9	121.0	131.0	167.0	177.0	3.6	3.2	0.42	1.44	0.79	3.76	1.72

[Note] 1) To the bearings with supplementary code "J" attached at the front of bearing number, tolerances shown in table 7-8 on page A72 are applied.

[Remark] Inch series tapered roller bearings with bore diameter larger than 100 mm are shown in catalog "large size ball & roller bearings".

Single-row tapered roller bearings
inch series

d (107.950) ~ 127.000 mm

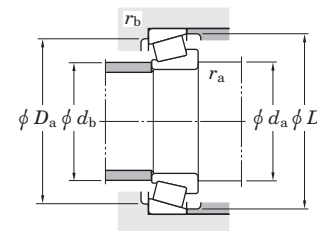
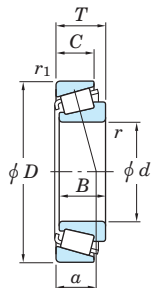

Boundary dimensions (mm)							Basic load ratings (kN)		Fatigue load limit (kN)	Limiting speeds (min ⁻¹)		Bearing No. ¹⁾	Load center (mm)	Mounting dimensions (mm)					Constant e	Axial load factors		(Refer.) Mass (kg)			
d	D	T	B	C	$r_{min.}$	$r_{1 min.}$	C_r	C_{0r}	C_u	Grease lub.	Oil lub.			Inner ring	Outer ring	d_a	d_b	D_a		D_b	$r_{a max.}$	$r_{b max.}$	Y_1	Y_0	Inner ring
107.950	212.725	66.675	66.675	53.975	7.9	3.2	563	674	84.1	1 800	2 400	936 HH224340	932 HH224310	47.6	137.0	122.0	187.0	193.0	7.9	3.2	0.33	1.84	1.01	6.52	4.07
	212.725	66.675	66.675	53.975	7.9	3.2	641	699	87.1	1 800	2 400			47.6	129.0	134.0	189.0	201.0	7.9	3.2	0.33	1.84	1.01	7.21	3.03
109.538	158.750	23.020	21.438	15.875	3.6	3.2	130	169	23.9	2 200	3 000	37431	37625	36.5	123.0	116.0	143.0	152.0	6.4	6.4	0.61	0.99	0.54	0.848	0.484
109.987	159.987	34.925	34.925	26.988	7.9	3.2	231	319	45.8	2 200	2 900	LM522548 LM522549	LM522510 LM522510	32.9	131.0	121.0	146.0	154.0	7.9	3.2	0.40	1.50	0.82	1.52	0.784
	159.987	34.925	34.925	26.988	3.6	3.2	231	319	45.8	2 200	2 900			32.9	123.0	121.0	146.0	154.0	3.6	3.2	0.40	1.50	0.82	1.55	0.784
109.992	177.800	41.275	41.275	30.162	3.6	3.2	294	380	53.4	2 000	2 700	64433R	64700	42.8	128.0	121.0	160.0	172.6	3.6	3.2	0.52	1.16	0.64	2.69	1.10
110.000	165.000	35.000	35.000	26.500	3.0	2.5	245	325	46.3	2 200	2 900	JM822049 JHM522649	JM822010 JHM522610	38.1	121.0	121.0	148.0	157.0	3.0	2.5	0.50	1.21	0.66	1.64	0.826
	180.000	47.000	46.000	38.000	3.0	2.5	385	487	62.3	2 000	2 700			40.6	121.0	125.0	160.0	171.0	3.0	2.5	0.41	1.48	0.81	3.08	1.49
114.300	177.800	41.275	41.275	30.162	3.6	3.2	294	380	53.4	2 000	2 700	64450R 68450 71450 938 HH224346 HH926744	64700 68712 71750 932 HH224310 HH926710	42.8	131.0	125.0	160.0	172.0	3.6	3.2	0.52	1.16	0.64	2.45	1.10
	180.975	34.925	31.750	25.400	3.6	3.2	216	247	35.1	2 000	2 700			40.6	127.0	131.0	161.0	170.0	3.6	3.2	0.50	1.21	0.66	1.89	1.04
	190.500	47.625	49.212	34.925	3.6	3.2	381	483	60.9	1 900	2 600			40.9	127.0	131.0	167.0	177.0	3.6	3.2	0.42	1.44	0.79	3.33	1.72
	212.725	66.675	66.675	53.975	7.1	3.2	563	674	84.1	1 800	2 400			47.6	141.0	128.0	187.0	193.0	7.1	3.2	0.33	1.84	1.01	5.96	4.07
	212.725	66.675	66.675	53.975	7.1	3.2	641	699	87.1	1 800	2 400			47.6	134.0	134.0	189.0	201.0	7.1	3.2	0.33	1.84	1.01	6.64	3.03
	273.050	82.550	82.550	53.975	6.4	6.4	885	898	104	1 500	1 900			76.1	133.0	151.0	230.0	252.0	6.4	6.4	0.63	0.95	0.52	15.0	6.97
114.976	212.725	66.675	66.675	53.975	7.1	3.2	641	699	87.1	1 800	2 400	HH224349	HH224310	47.6	135.0	134.0	189.0	201.0	7.1	3.2	0.33	1.84	1.01	6.58	3.03
115.087	190.500	47.625	49.212	34.925	3.6	3.2	381	483	60.9	1 900	2 600	71453 71455	71750 71750	40.9	133.0	126.0	171.0	181.0	3.6	3.2	0.42	1.44	0.79	3.28	1.72
	190.500	47.625	49.212	34.925	7.9	3.2	381	483	60.9	1 900	2 600			40.9	136.0	131.0	167.0	177.0	7.9	3.2	0.42	1.44	0.79	3.25	1.72
117.475	180.975	34.925	31.750	25.400	3.6	3.2	216	247	35.1	2 000	2 700	68462 68463	68712 68712	40.6	130.0	131.0	161.0	170.0	3.6	3.2	0.50	1.21	0.66	1.75	1.04
	180.975	34.925	31.750	25.400	7.9	3.2	216	247	35.1	2 000	2 700			40.6	141.0	125.0	163.0	172.0	7.9	3.2	0.50	1.21	0.66	1.61	1.05
120.650	190.500	46.038	46.038	34.925	3.6	1.6	393	512	63.9	1 900	2 500	HM624749 HH228340	HM624710 HH228310	41.6	146.0	132.0	174.0	184.0	3.6	1.6	0.43	1.41	0.77	3.20	1.44
	254.000	77.788	82.550	61.912	9.5	6.4	895	1 050	125	1 500	2 000			54.3	158.0	142.0	223.0	234.0	9.5	6.4	0.32	1.87	1.03	12.6	6.00
127.000	254.000	77.788	82.550	61.912	9.5	6.4	895	1 050	125	1 500	2 000	HH228349	HH228310	54.3	164.0	148.0	223.0	234.0	9.5	6.4	0.32	1.87	1.03	11.8	6.00

[Note] 1) To the bearings with supplementary code "J" attached at the front of bearing number, tolerances shown in table 7-8 on page A72 are applied.

[Remark] Inch series tapered roller bearings with bore diameter larger than 100 mm are shown in catalog "large size ball & roller bearings".

Single-row tapered roller bearings
inch series

d 133.350 ~ 292.100 mm

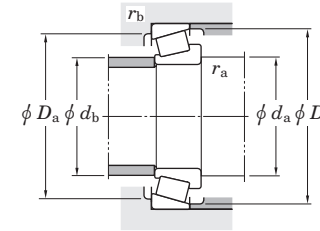
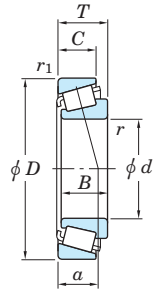

Boundary dimensions (mm)							Basic load ratings (kN)		Fatigue load limit (kN) C_u	Limiting speeds (min^{-1})		Bearing No. ¹⁾	Load center (mm) a	Mounting dimensions (mm)						Constant e	Axial load factors		(Refer.) Mass (kg)		
d	D	T	B	C	r_{min}	$r_{1 \text{ min}}$	C_r	C_{0r}		Grease lub.	Oil lub.			Inner ring	Outer ring	d_a	d_b	D_a	D_b		$r_{a \text{ max}}$	$r_{b \text{ max}}$	Y_1	Y_0	Inner ring
133.350	177.008	25.400	26.195	20.638	1.6	1.6	176	278	38.2	1 900	2 500	L327249	L327210	29.1	142.0	145.0	164.0	171.0	1.6	1.6	0.35	1.72	0.95	1.14	0.543
142.875	200.025	41.275	39.688	34.130	7.9	3.3	307	491	66.5	1 700	2 200	48684	48620	38.4	166.0	151.0	185.0	193.0	7.9	3.3	0.34	1.78	0.98	2.43	1.38
	200.025	41.275	39.688	34.130	3.6	3.3	307	491	66.5	1 700	2 200	48685	48620	38.4	156.0	157.0	182.0	192.0	3.6	3.3	0.34	1.78	0.98	2.46	1.38
170.000	230.000	39.000	38.000	31.000	3.0	2.5	363	558	72.8	1 400	1 900	JHM534149	JHM534110	43.6	181.0	184.0	214.0	222.0	3.0	2.5	0.38	1.57	0.86	3.17	1.29
	240.000	46.000	44.500	37.000	3.0	2.5	443	666	77.1	1 400	1 800	JM734449	JM734410	50.6	181.0	184.0	220.0	231.0	3.0	2.5	0.44	1.37	0.75	4.31	2.00
171.450	222.250	25.400	24.608	19.050	1.6	1.6	197	299	38.7	1 400	1 900	L435049	L435010	36.0	181.0	179.0	211.0	215.0	1.6	1.6	0.38	1.60	0.88	1.63	0.697
180.000	250.000	47.000	45.000	37.000	3.0	2.5	456	705	81.7	1 300	1 700	JM736149	JM736110	55.2	191.0	193.0	230.0	242.0	3.0	2.5	0.48	1.25	0.69	4.47	2.10
190.000	260.000	46.000	44.000	36.500	3.0	2.5	461	723	81.4	1 200	1 700	JM738249	JM738210	56.0	201.0	203.0	240.0	251.0	3.0	2.5	0.48	1.26	0.69	4.71	2.18
196.850	254.000	28.575	27.783	21.433	1.6	1.6	236	387	48.2	1 200	1 600	L540049	L540010	43.1	206.0	214.0	238.0	245.0	1.6	1.6	0.40	1.51	0.83	2.34	1.02
200.000	300.000	65.000	62.000	51.000	3.6	2.5	773	1 140	124	1 100	1 500	JHM840449	JHM840410	72.1	213.0	218.0	270.0	288.0	3.6	2.5	0.52	1.15	0.63	9.97	5.13
220.878	317.500	47.625	52.388	36.513	3.2	3.2	611	928	103	970	1 300	LM245833	LM245810	50.5	234.0	253.0	296.0	304.0	3.2	3.2	0.33	1.80	0.99	9.56	2.78
228.600	358.775	71.438	71.438	53.975	3.6	3.2	968	1 590	166	840	1 100	M249732	M249710	64.4	242.0	279.0	330.0	343.0	3.6	3.2	0.33	1.80	0.99	20.1	6.44
230.188	317.500	47.625	52.388	36.513	3.2	3.2	611	928	103	970	1 300	LM245846	LM245810	50.5	242.0	238.0	309.0	312.0	3.2	3.2	0.33	1.80	0.99	8.25	2.78
231.775	317.500	47.625	52.388	36.513	3.2	3.2	611	928	103	970	1 300	LM245848	LM245810	50.5	244.0	240.0	309.0	312.0	3.2	3.2	0.33	1.80	0.99	8.02	2.78
	336.550	65.088	65.088	50.800	6.4	3.2	887	1 380	150	920	1 200	M246942	M246910	59.9	258.0	249.0	313.0	322.0	6.4	3.2	0.33	1.80	0.99	13.1	5.44
	358.775	71.438	71.438	53.975	6.4	3.2	968	1 590	166	920	1 200	M249734	M249710	64.4	258.0	253.0	335.0	343.0	6.4	3.2	0.33	1.80	0.99	19.9	6.44
254.000	358.775	71.438	71.438	53.975	3.6	3.2	968	1 590	166	840	1 100	M249749	M249710	64.4	268.0	279.0	330.0	343.0	3.6	3.2	0.33	1.80	0.99	14.8	6.44
257.175	342.900	57.150	57.150	44.450	6.4	3.2	764	1 280	135	870	1 200	M349549	M349510	60.1	276.0	276.0	320.0	330.0	6.4	3.2	0.35	1.73	0.95	9.27	3.99
292.100	374.650	47.625	47.625	34.925	3.6	3.2	587	971	111	760	1 000	L555249	L555210	64.7	306.0	309.0	351.0	360.0	3.6	3.2	0.40	1.49	0.82	7.97	3.53

[Note] 1) To the bearings with supplementary code "J" attached at the front of bearing number, tolerances shown in table 7-8 on page A72 are applied.

[Remark] Inch series tapered roller bearings with bore diameter larger than 100 mm are shown in catalog "large size ball & roller bearings".

Double-row tapered roller bearings TDO type

d 25 ~ (60) mm

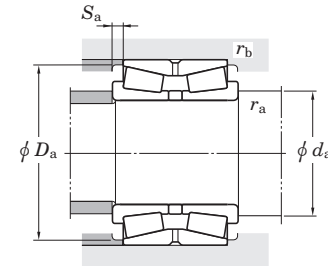
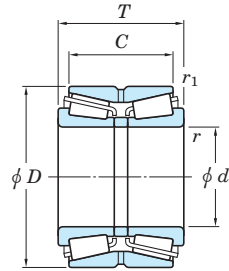

Boundary dimensions (mm)						Basic load ratings (kN)		Fatigue load limit (kN)	Limiting speeds (min ⁻¹)		Bearing No.	Mounting dimensions (mm)					Constant e	Axial load factors			(Refer.) Mass (kg)
d	D	T	C	r min.	r1 min.	Cr	Cor	Cu	Grease lub.	Oil lub.		da min.	Da min.	Sa min.	ra max.	rb max.		Y2	Y3	Y0	
25	62	40	29.5	1.5	0.6	85.2	84.9	5.80	4 500	6 400	46T30305DJR/29.5	33.5	58.5	5	1.5	0.6	0.83	0.82	1.22	0.8	0.592
30	72	45	31.5	1.5	0.6	109	110	7.70	3 900	5 400	46T30306DJR/31.5	38.5	68	6.5	1.5	0.6	0.83	0.82	1.22	0.8	0.872
35	80	51	35.5	2	0.6	135	138	9.85	3 400	4 800	46T30307DJR/35.5	45	76.5	7.5	2	0.6	0.83	0.82	1.22	0.8	1.2
40	80	45	37.5	1.5	0.6	134	138	10.3	4 000	5 300	46T30208JR/37.5	48.5	75	3.5	1.5	0.6	0.37	1.8	2.68	1.76	0.954
	80	55	43.5	1.5	0.6	166	182	13.6	4 000	5 300	46T32208JR/43.5	48.5	75	5.5	1.5	0.6	0.37	1.8	2.68	1.76	1.19
	90	56	39.5	2	0.6	172	180	13.1	3 000	4 200	46T30308DJR/39.5	50	86.5	8	2	0.6	0.83	0.82	1.22	0.8	1.67
	90	56	45.5	2	0.6	194	202	15.5	3 600	4 900	46T30308JR/45.5	50	82	5	2	0.6	0.35	1.96	2.91	1.91	1.67
45	85	47	37.5	1.5	0.6	144	155	11.6	3 700	4 900	46T30209JR/37.5	53.5	80	4.5	1.5	0.6	0.4	1.67	2.48	1.63	1.1
	85	55	43.5	1.5	0.6	180	207	15.6	3 700	4 900	46T32209JR-1/43.5	53.5	81	5.5	1.5	0.6	0.4	1.67	2.48	1.63	1.31
	100	60	41.5	2	0.6	204	214	15.8	2 700	3 800	46T30309DJR/41.5	55	96	9	2	0.6	0.83	0.82	1.22	0.8	2.15
	100	60	49.5	2	0.6	242	256	19.9	3 300	4 300	46T30309JR/49.5	55	93	5	2	0.6	0.35	1.96	2.91	1.91	2.2
50	90	49	39.5	1.5	0.6	164	183	13.8	3 400	4 600	46T30210JR/39.5	58.5	85	4.5	1.5	0.6	0.42	1.61	2.39	1.57	1.22
	90	55	43.5	1.5	0.6	182	211	15.9	3 500	4 600	46T32210JR/43.5	58.5	85	5.5	1.5	0.6	0.42	1.61	2.39	1.57	1.39
	110	64	51.5	2	0.6	295	305	24.0	3 000	4 000	46T30310JR/51.5	62	102	6	2	0.6	0.35	1.96	2.91	1.91	2.68
	110	73	52.5	2	0.6	247	266	19.8	2 500	3 500	46T30310DJR/52.5	62	105	10	2	0.6	0.83	0.82	1.22	0.8	3.11
	110	90	71.5	2	0.6	378	440	34.2	3 000	4 000	46T32310JR/71.5	62	102	9	2	0.6	0.35	1.96	2.91	1.91	3.95
55	100	51	41.5	2	0.6	203	226	17.3	3 100	4 100	46T30211JR/41.5	65	94	4.5	2	0.6	0.4	1.67	2.48	1.63	1.6
	100	60	48.5	2	0.6	230	266	20.5	3 100	4 100	46T32211JR-1/48.5	65	95	5.5	2	0.6	0.4	1.67	2.48	1.63	1.87
	120	70	49	2	0.6	276	297	22.3	2 300	3 200	46T30311DJR/49	67	113	10.5	2	0.6	0.83	0.82	1.22	0.8	3.54
	120	70	57	2	0.6	320	341	27.0	2 700	3 600	46T30311JR/57	67	111	6.5	2	0.6	0.35	1.96	2.91	1.91	3.57
	120	97	76	2	0.6	429	500	39.1	2 700	3 600	46T32311JR/76	67	111	10.5	2	0.6	0.35	1.96	2.91	1.91	4.98
60	110	53	43.5	2	0.6	228	254	19.7	2 800	3 800	46T30212JR/43.5	70	103	4.5	2	0.6	0.4	1.67	2.48	1.63	2.04
	110	66	54.5	2	0.6	282	334	25.9	2 800	3 800	46T32212JR/54.5	70	104	5.5	2	0.6	0.4	1.67	2.48	1.63	—
	130	74	51	2.5	1	327	359	27.1	2 100	2 900	46T30312DJR/51	74	124	11.5	2.5	1	0.83	0.82	1.22	0.8	4.45
	130	74	59	2.5	1	372	401	31.9	2 500	3 300	46T30312JR/59	74	120	7.5	2.5	1	0.35	1.96	2.91	1.91	4.46

[Remark] Bearings not shown above (e.g. inch series) are shown in catalog "large size ball & roller bearings".

Double-row tapered roller bearings TDO type

d (60) ~ (90) mm

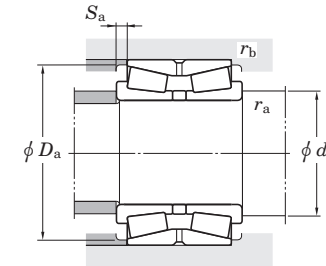
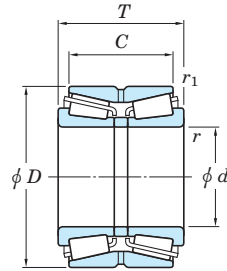

Boundary dimensions (mm)						Basic load ratings (kN)		Fatigue load limit (kN)	Limiting speeds (min ⁻¹)		Bearing No.	Mounting dimensions (mm)					Constant e	Axial load factors			(Refer.) Mass (kg)
d	D	T	C	$r_{min.}$	$r_{1 min.}$	C_r	C_{Or}	C_u	Grease lub.	Oil lub.		d_a min.	D_a min.	S_a min.	r_a max.	r_b max.		Y_2	Y_3	Y_0	
60	130	104	81	2.5	1	524	629	44.1	2 500	3 300	46T32312JR/81	74	120	11.5	2.5	1	0.35	1.96	2.91	1.91	6.45
65	120	56	46.5	2	0.6	275	311	24.3	2 600	3 400	46T30213JR/46.5	75	113	4.5	2	0.6	0.4	1.67	2.48	1.63	—
	120	73	61.5	2	0.6	337	406	31.7	2 600	3 400	46T32213JR/61.5	75	115	5.5	2	0.6	0.4	1.67	2.48	1.63	3.4
	140	79	53	2.5	1	377	417	31.4	1 900	2 700	46T30313DJR/53	79	133	13	2.5	1	0.83	0.82	1.22	0.8	5.3
	140	79	63	2.5	1	437	478	37.6	2 300	3 000	46T30313JR/63	79	130	8	2.5	1	0.35	1.96	2.91	1.91	5.51
	140	108	84	2.5	1	593	714	49.6	2 300	3 100	46T32313JR/84	79	130	12	2.5	1	0.35	1.96	2.91	1.91	7.71
70	125	59	48.5	2	0.6	296	346	27.1	2 400	3 300	46T30214JR/48.5	80	118	5	2	0.6	0.42	1.61	2.39	1.57	—
	125	74	61.5	2	0.6	363	450	35.2	2 400	3 300	46T32214JR/61.5	80	119	6	2	0.6	0.42	1.61	2.39	1.57	3.7
	150	83	57	2.5	1	421	470	34.9	1 800	2 500	46T30314DJR/57	84	142	13	2.5	1	0.83	0.82	1.22	0.8	6.48
	150	83	67	2.5	1	493	546	42.2	2 100	2 800	46T30314JR/67	84	140	8	2.5	1	0.35	1.96	2.91	1.91	6.65
	150	116	92	2.5	1	679	829	57.2	2 200	2 900	46T32314JR/92	84	140	12	2.5	1	0.35	1.96	2.91	1.91	9.46
75	115	30	26	1.5	0.6	89.9	105	7.30	2 500	3 300	46215	83.5	106.5	2	1.5	0.6	0.32	2.12	3.15	2.07	0.994
	115	38	30	1.5	0.6	153	207	15.6	2 500	3 300	46215A	83.5	107.4	4	1.5	0.6	0.32	2.12	3.15	2.07	1.32
	130	62	51.5	2	0.6	305	362	28.2	2 300	3 100	46T30215JR/51.5	85	124	5	2	0.6	0.44	1.55	2.31	1.52	3.12
	130	74	61.5	2	0.6	373	469	36.4	2 300	3 100	46T32215JR/61.5	85	125	6	2	0.6	0.44	1.55	2.31	1.52	3.85
	160	87	69	2.5	1	557	621	44.9	2 000	2 600	46T30315JR/69	89	149	9	2.5	1	0.35	1.96	2.91	1.91	7.8
	160	125	99	2.5	1	779	963	64.6	2 000	2 700	46T32315JR/99	89	149	13	2.5	1	0.35	1.96	2.91	1.91	11.5
80	125	34	30	1.5	0.6	136	155	11.3	2 300	3 100	46216	88.5	116.9	2	1.5	0.6	0.35	1.95	2.90	1.91	1.38
	140	64	51.5	2	0.6	346	405	31.2	2 200	2 900	46T30216JR/51.5	92	132	6	2	0.6	0.42	1.61	2.39	1.57	3.76
	140	78	63.5	2	0.6	434	542	41.5	2 200	2 900	46T32216JR/63.5	92	134	7	2	0.6	0.42	1.61	2.39	1.57	4.71
	170	92	73	2.5	1	630	711	49.9	1 800	2 500	46T30316JR/73	94	159	9.5	2.5	1	0.35	1.96	2.91	1.91	9.44
85	150	70	57	2	0.6	391	463	35.1	2 000	2 700	46T30217JR/57	97	141	6.5	2	0.6	0.42	1.61	2.39	1.57	4.79
	150	86	69	2	0.6	498	630	47.5	2 000	2 700	46T32217JR/69	97	142	8.5	2	0.6	0.42	1.61	2.39	1.57	6.05
	180	98	77	3	1	679	768	53.0	1 700	2 300	46T30317JR/77	103	167	10.5	3	1	0.35	1.96	2.91	1.91	11
	180	137	108	3	1	941	1 170	77.6	1 800	2 400	46T32317JR/108	103	167	14.5	3	1	0.35	1.96	2.91	1.91	16
90	140	37	33	2	0.6	171	199	14.4	2 100	2 800	46218	100	130.6	2	2	0.6	0.35	1.95	2.90	1.91	1.89

[Remark] Bearings not shown above (e.g. inch series) are shown in catalog "large size ball & roller bearings".

Double-row tapered roller bearings
TDO type

d (90) ~ 110 mm

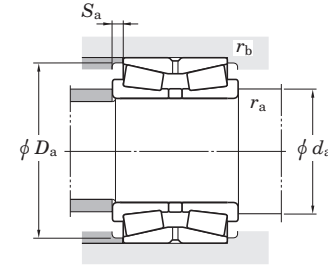
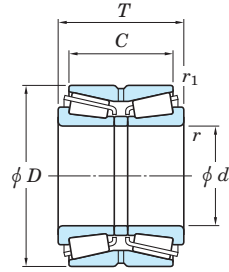

Boundary dimensions (mm)						Basic load ratings (kN)		Fatigue load limit (kN)	Limiting speeds (min ⁻¹)		Bearing No.	Mounting dimensions (mm)					Constant	Axial load factors			(Refer.) Mass (kg)
d	D	T	C	r min.	r1 min.	Cr	Cor	Cu	Grease lub.	Oil lub.		da min.	Da min.	Sa min.	ra max.	rb max.	e	Y2	Y3	Y0	Mass
90	140	46	37	2	0.6	196	266	19.6	2 000	2 700	46218A 46T30218JR/61 46T32218JR/77 46T30318JR/81 46T32318JR/115	100	129.9	4.5	2	0.6	0.32	2.12	3.15	2.07	2.37
	160	74	61	2	0.6	438	522	39.0	1 900	2 500		102	150	6.5	2	0.6	0.42	1.61	2.39	1.57	5.85
	160	94	77	2	0.6	565	724	53.7	1 900	2 500		102	152	8.5	2	0.6	0.42	1.61	2.39	1.57	7.53
	190	102	81	3	1	741	841	57.1	1 600	2 200		108	177	10.5	3	1	0.35	1.96	2.91	1.91	13
	190	144	115	3	1	989	1 230	78.7	1 700	2 200		108	177	14.5	3	1	0.35	1.96	2.91	1.91	18.6
95	170	78	63	2.5	1	496	598	44.0	1 800	2 400	46T30219JR/63 46T32219JR/83 46T30319JR/85 46T32319JR/118	109	159	7.5	2.5	1	0.42	1.61	2.39	1.57	7.01
	170	100	83	2.5	1	667	877	64.1	1 800	2 400		109	161	8.5	2.5	1	0.42	1.61	2.39	1.57	9.25
	200	108	85	3	1	798	909	60.9	1 600	2 100		113	186	11.5	3	1	0.35	1.96	2.91	1.91	14.8
	200	151	118	3	1	1 110	1 390	89.2	1 600	2 100		113	186	16.5	3	1	0.35	1.96	2.91	1.91	21.4
100	150	46	37	2	0.6	226	293	21.3	1 900	2 500	46220A 46320 46320A 46T30220JR/67 46T32220JR/87 46T30320JR/87 46T32320JR/127	110	142	4.5	2	0.6	0.35	1.95	2.90	1.91	2.53
	165	52	46	2.5	0.6	249	305	22.0	1 700	2 300		112	154	3	2	0.6	0.35	1.95	2.90	1.91	4.03
	165	65	52	2.5	0.6	333	443	32.4	1 800	2 300		112	153	6.5	2	0.6	0.35	1.95	2.90	1.91	4.97
	180	83	67	2.5	1	554	676	49.1	1 700	2 200		114	168	8	2.5	1	0.42	1.61	2.39	1.57	8.33
	180	107	87	2.5	1	745	990	63.9	1 700	2 200		114	171	10	2.5	1	0.42	1.61	2.39	1.57	11.1
	215	112	87	3	1	906	1 040	68.0	1 500	1 900		118	200	12.5	3	1	0.35	1.96	2.91	1.91	18.1
	215	162	127	3	1	1 240	1 570	96.9	1 500	2 000		118	200	17.5	3	1	0.35	1.96	2.91	1.91	27.2
105	190	88	70	2.5	1	618	761	52.3	1 600	2 100	46T30221JR/70 46T32221JR/95 46T30321JR/91 46T32321JR/133	119	178	9	2.5	1	0.42	1.61	2.39	1.57	9.87
	190	115	95	2.5	1	840	1 130	73.0	1 600	2 100		119	180	10	2.5	1	0.42	1.61	2.39	1.57	13.5
	225	116	91	3	1	995	1 160	73.6	1 400	1 800		123	209	12.5	3	1	0.35	1.96	2.91	1.91	20.7
	225	170	133	3	1	1 360	1 730	107	1 400	1 900		123	209	18.5	3	1	0.35	1.96	2.91	1.91	30.9
110	170	45	40	2.5	0.6	219	304	21.2	1 700	2 200	46222 46322 46322A 46T30222JR/74 46T32222JR/101 46T30322JR/93 46T32322JR/142	122	158	2.5	2	0.6	0.35	1.95	2.90	1.91	3.58
	180	56	50	2.5	0.6	308	388	27.7	1 600	2 100		122	168	3	2	0.6	0.35	1.95	2.90	1.91	5.13
	180	70	56	2.5	0.6	391	533	38.1	1 600	2 100		122	168	7	2	0.6	0.35	1.92	2.86	1.88	6.43
	200	92	74	2.5	1	695	868	58.1	1 500	2 000		124	188	9	2.5	1	0.42	1.61	2.39	1.57	11.6
	200	121	101	2.5	1	938	1 280	80.4	1 500	2 000		124	190	10	2.5	1	0.42	1.61	2.39	1.57	15.9
	240	118	93	3	1	1 030	1 180	75.2	1 300	1 700		128	222	12.5	3	1	0.35	1.96	2.91	1.91	23.8
	240	181	142	3	1	1 480	1 890	115	1 300	1 700		128	222	19.5	3	1	0.35	1.96	2.91	1.91	37.3

[Remark] Bearings not shown above (e.g. inch series) are shown in catalog "large size ball & roller bearings".

Double-row tapered roller bearings
TDO type

d 120 ~ (150) mm

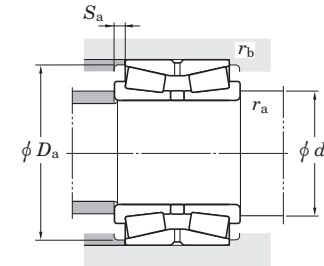
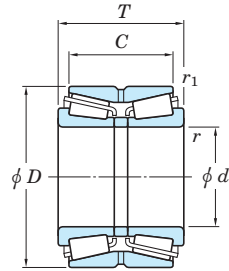

Boundary dimensions (mm)						Basic load ratings (kN)		Fatigue load limit (kN) C_u	Limiting speeds (min^{-1})		Bearing No.	Mounting dimensions (mm)					Con-stant e	Axial load factors			(Refer.) Mass (kg)
d	D	T	C	r_{min}	r_1_{min}	C_r	C_{Or}		Grease lub.	Oil lub.		d_a_{min}	D_a_{min}	S_a_{min}	r_a_{max}	r_b_{max}		Y_2	Y_3	Y_0	
120	180	46	41	2.5	0.6	232	317	21.8	1 500	2 000	46224 46224A 46324 46324A 46324AS 46T30224JR/78 46T32224JR/109 46T30324JR/101 46T32324JR/145	132	170	2.5	2	0.6	0.35	1.95	2.90	1.91	3.81
	180	58	46	2.5	0.6	309	460	32.2	1 500	2 100		132	169	6	2	0.6	0.35	1.95	2.90	1.91	4.66
	200	62	55	2.5	0.6	367	470	32.8	1 400	1 900		132	184	3.5	2	0.6	0.35	1.95	2.90	1.91	7.28
	200	78	62	2.5	0.6	486	672	47.0	1 400	1 900		132	185	8	2	0.6	0.35	1.95	2.90	1.91	9.14
	200	100	84	2.5	0.6	670	1 010	62.5	1 400	1 900		132	190	8	2	0.6	0.35	1.95	2.90	1.91	12.0
	215	97	78	2.5	1	745	945	61.7	1 400	1 800		134	203	9.5	2.5	1	0.44	1.55	2.31	1.52	13.9
	215	132	109	2.5	1	1 010	1 380	84.0	1 400	1 900		134	204	11.5	2.5	1	0.44	1.55	2.31	1.52	19.8
	260	128	101	3	1	1 220	1 430	89.9	1 200	1 600		138	239	13.5	3	1	0.35	1.96	2.91	1.91	30.6
	260	188	145	4	1.5	1 720	2 210	131	1 200	1 600		142	239	21.5	4	1.5	0.35	1.96	2.91	1.91	45.9
	130	200	52	46	2.5	0.6	299	425	28.9	1 400		1 800	46226 46226A 46326 46326A 46T30226JR/78.5 46T32226JR/117.5 46T30326JR/107.5	142	187	3	2	0.6	0.35	1.95	2.90
200		65	52	2.5	0.6	400	618	42.5	1 400	1 900	142	185		6.5	2	0.6	0.35	1.95	2.90	1.91	7.06
210		64	57	2.5	0.6	404	535	36.8	1 400	1 800	142	196		3.5	2	0.6	0.36	1.87	2.79	1.83	7.81
210		80	64	2.5	0.6	513	723	49.7	1 300	1 800	142	198		8	2	0.6	0.36	1.87	2.79	1.83	9.57
230		98	78.5	3	1	809	1 020	65.7	1 300	1 700	148	218		9.5	3	1	0.44	1.55	2.31	1.52	15.7
230		145	117.5	3	1	1 190	1 660	99.9	1 300	1 700	148	219		14	3	1	0.44	1.55	2.31	1.52	24.1
280		137	107.5	4	1.5	1 410	1 670	102	1 100	1 400	152	255		15	4	1.5	0.35	1.96	2.91	1.91	38.1
140		210	53	47	2.5	0.6	299	404	27.3	1 300	1 800	46228 46228A 46328 46328A 46T30228JR/82.5 46T32228JR/125.5 46T30328JR/115.5		152	196	3	2	0.6	0.33	2.03	3.02
	210	66	53	2.5	0.6	452	639	43.4	1 300	1 800	152		199	6.5	2	0.6	0.47	1.43	2.12	1.40	7.18
	225	68	61	3	1	423	564	38.1	1 200	1 700	154		210	3.5	2.5	1	0.35	1.95	2.90	1.91	9.56
	225	85	68	3	1	597	836	56.6	1 200	1 700	154		212	8	2.5	1	0.35	1.95	2.90	1.91	11.8
	250	102	82.5	3	1	902	1 140	71.8	1 200	1 500	158		237	9.5	3	1	0.44	1.55	2.31	1.52	19.7
	250	153	125.5	3	1	1 360	1 920	112	1 200	1 600	158		238	14	3	1	0.44	1.55	2.31	1.52	30.2
	300	145	115.5	4	1.5	1 610	1 920	114	1 000	1 300	162		273	15	4	1.5	0.35	1.96	2.91	1.91	46.6
	150	225	56	50	3	1	348	476	31.6	1 200	1 600		46230 46230A 46330 46330A 46T30230JR/87	164	213	3	2.5	1	0.33	2.03	3.02
225		70	56	3	1	472	703	47.0	1 200	1 600	164	213		7	2.5	1	0.33	2.03	3.02	1.98	8.82
250		80	71	3	1	587	786	49.2	1 100	1 500	164	233		4.5	2.5	1	0.35	1.95	2.90	1.91	14.6
250		100	80	3	1	748	1 070	66.2	1 100	1 500	164	234		10	2.5	1	0.35	1.95	2.90	1.91	17.6
270		109	87	3	1	1 040	1 330	80.9	1 100	1 400	168	255		11	3	1	0.44	1.55	2.31	1.52	24.6

[Remark] Bearings not shown above (e.g. inch series) are shown in catalog "large size ball & roller bearings".

Double-row tapered roller bearings
TDO type

d (150) ~ (200) mm

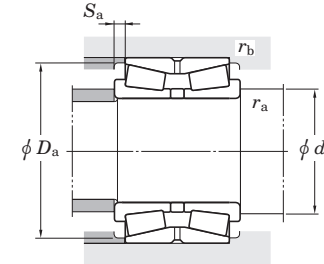
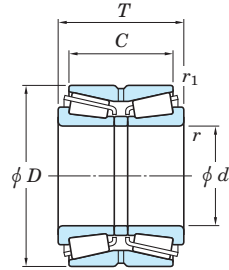

Boundary dimensions (mm)						Basic load ratings (kN)		Fatigue load limit (kN)	Limiting speeds (min ⁻¹)		Mounting dimensions (mm)	Constant e	Axial load factors			(Refer.) Mass (kg)					
d	D	T	C	r min.	r1 min.	C _r	C _{0r}	C _u	Grease lub.	Oil lub.			d _a min.	D _a min.	S _a min.		r _a max.	r _b max.	Y ₂	Y ₃	Y ₀
150	270	164	130	3	1	1 510	2 130	122	1 100	1 400	46T32230JR/130 46T30330JR/120	168	254	17	3	1	0.44	1.55	2.31	1.52	38
	320	154	120	4	1.5	1 800	2 160	129	930	1 200		172	292	17	4	1.5	0.35	1.96	2.91	1.91	56
160	240	60	53	3	1	405	565	37.0	1 100	1 500	46232 46232A 46332 46332A 46T30232JR/91 46T32232JR/144	174	228	3.5	2.5	1	0.33	2.03	3.02	1.98	8.71
	240	75	60	3	1	508	756	49.8	1 100	1 500		174	226	7.5	2.5	1	0.33	2.03	3.02	1.98	10.6
	270	86	76	3	1	695	950	57.5	1 000	1 400		174	252	5	2.5	1	0.35	1.95	2.90	1.91	18.8
	270	108	86	3	1	871	1 270	75.1	1 000	1 400		174	252	11	2.5	1	0.35	1.95	2.90	1.91	23.1
	290	115	91	3	1	1 160	1 500	89.3	980	1 300		178	269	12	3	1	0.44	1.55	2.31	1.52	29.9
	290	178	144	3	1	1 700	2 420	137	1 000	1 300		178	274	17	3	1	0.44	1.55	2.31	1.52	47.6
170	260	67	60	3	1	480	642	41.7	1 000	1 400	46234 46234A 46334 46334A 46T30234JR/97 46T32234JR/152	184	243	3.5	2.5	1	0.33	2.03	3.02	1.98	11.4
	260	84	67	3	1	629	969	62.6	1 000	1 400		184	244	8.5	2.5	1	0.33	2.03	3.02	1.98	14.7
	280	88	78	3	1	754	1 050	62.5	970	1 300		184	263	5	2.5	1	0.33	2.06	3.06	2.01	19.8
	280	110	88	3	1	938	1 390	81.5	980	1 300		184	260	11	2.5	1	0.33	2.06	3.06	2.01	24.7
	310	125	97	4	1.5	1 330	1 730	103	900	1 200		192	288	14	4	1.5	0.44	1.55	2.31	1.52	37.5
	310	192	152	4	1.5	1 930	2 760	152	910	1 200		192	294	20	4	1.5	0.44	1.55	2.31	1.52	58.8
180	280	74	66	3	1	582	801	49.4	950	1 300	46236 46236A 46336 46336A 46T30236JR/99 46T32236JR/152	194	263	4	2.5	1	0.33	2.03	3.02	1.98	15.5
	280	93	74	3	1	732	1 080	65.6	960	1 300		194	261	9.5	2.5	1	0.33	2.03	3.02	1.98	19.0
	300	96	85	4	1.5	872	1 240	74.5	910	1 200		198	277	5.5	3	1.5	0.33	2.06	3.06	2.01	25.8
	300	120	96	4	1.5	1 080	1 630	95.1	900	1 200		198	279	12	3	1.5	0.33	2.06	3.06	2.01	31.3
	320	127	99	4	1.5	1 320	1 740	102	860	1 200		202	297	14	4	1.5	0.45	1.5	2.23	1.47	40.1
	320	192	152	4	1.5	2 060	3 030	164	880	1 200		202	303	20	4	1.5	0.45	1.5	2.23	1.47	62.5
190	290	75	67	3	1	610	866	52.9	910	1 200	46238 46238A 46338 46338A 46T30238JR/105 46T32238JR/160	204	272	4	2.5	1	0.32	2.12	3.15	2.07	16.5
	290	94	75	3	1	793	1 170	70.2	900	1 200		204	274	9.5	2.5	1	0.33	2.03	3.02	1.98	20.0
	320	104	92	4	1.5	1 020	1 450	84.1	830	1 100		208	298	6	3	1.5	0.35	1.95	2.90	1.91	31.9
	320	130	104	4	1.5	1 230	1 860	106	840	1 100		208	298	13	3	1.5	0.35	1.95	2.90	1.91	39.0
	340	133	105	4	1.5	1 560	2 060	118	800	1 100		212	318	14	4	1.5	0.44	1.55	2.31	1.52	47.8
	340	204	160	4	1.5	2 340	3 480	187	810	1 100		212	323	22	4	1.5	0.44	1.55	2.31	1.52	75.1
200	310	82	73	3	1	716	1 040	61.6	850	1 100	46240	214	288	4.5	2.5	1	0.32	2.12	3.15	2.07	21.4

[Remark] Bearings not shown above (e.g. inch series) are shown in catalog "large size ball & roller bearings".

Double-row tapered roller bearings

TDO type

d (200) ~ (300) mm

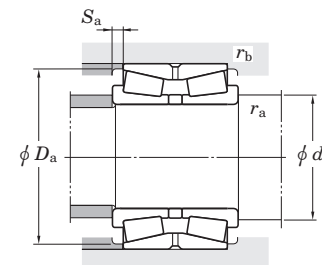
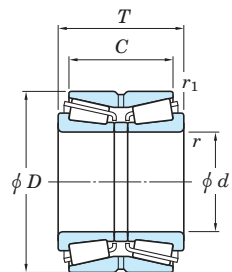

Boundary dimensions (mm)						Basic load ratings (kN)		Fatigue load limit (kN)	Limiting speeds (min ⁻¹)		Bearing No.	Mounting dimensions (mm)					Constant e	Axial load factors			(Refer.) Mass (kg)
d	D	T	C	r min.	r_1 min.	C_r	C_{Or}	C_u	Grease lub.	Oil lub.		d_a min.	D_a min.	S_a min.	r_a max.	r_b max.		Y_2	Y_3	Y_0	
200	310	103	82	3	1	893	1 380	80.2	840	1 100	46240A 46340 46340A 46T30240JR/110 46T32240JR/174	214	289	10.5	2.5	1	0.32	2.12	3.15	2.07	26.3
	340	112	100	4	1.5	1 100	1 580	90.2	780	1 000		218	316	6	3	1.5	0.35	1.95	2.90	1.91	39.6
	340	140	112	4	1.5	1 350	2 040	113	770	1 000		218	319	14	3	1.5	0.35	1.95	2.90	1.91	48.2
	360	142	110	4	1.5	1 700	2 240	126	750	1 000		222	336	16	4	1.5	0.44	1.55	2.31	1.52	56.5
	360	218	174	4	1.5	2 660	3 760	200	770	1 000		222	340	22	4	1.5	0.41	1.66	2.47	1.62	88.2
220	340	90	80	4	1.5	849	1 240	71.0	750	990	46244 46244A 46344 46344A 46T30244JR/114	238	319	5	3	1.5	0.32	2.12	3.15	2.07	27.8
	340	113	90	4	1.5	1 040	1 620	91.5	750	1 000		238	318	11.5	3	1.5	0.32	2.12	3.15	2.07	34.2
	370	120	107	5	1.5	1 260	1 810	101	700	930		242	346	6.5	4	1.5	0.35	1.95	2.90	1.91	49.1
	370	150	120	5	1.5	1 600	2 470	136	710	940		242	343	15	4	1.5	0.35	1.95	2.90	1.91	60.1
	400	150	114	4	1.5	2 170	2 880	160	660	890		242	371	18	4	1.5	0.42	1.61	2.39	1.57	75.8
240	360	92	82	4	1.5	962	1 430	79.7	690	920	46248 46248A 46348 46348A	258	338	5	3	1.5	0.32	2.12	3.15	2.07	29.6
	360	115	92	4	1.5	1 240	1 980	108	690	920		258	341	11.5	3	1.5	0.32	2.12	3.15	2.07	36.9
	400	128	114	5	1.5	1 490	2 180	121	630	840		262	377	7	4	1.5	0.35	1.95	2.90	1.91	59.0
	400	160	128	5	1.5	1 940	3 060	162	630	850		262	373	16	4	1.5	0.35	1.95	2.90	1.91	76.2
260	400	104	92	5	1.5	1 170	1 830	100	610	820	46252 46252A 46352 46352A	282	373	6	4	1.5	0.33	2.03	3.02	1.98	44.6
	400	130	104	5	1.5	1 520	2 480	133	610	810		282	376	13	4	1.5	0.32	2.12	3.15	2.07	54.8
	440	144	128	5	1.5	1 900	2 880	151	560	750		282	410	8	4	1.5	0.35	1.95	2.90	1.91	83.8
	440	180	144	5	1.5	2 430	3 960	204	570	760		282	409	18	4	1.5	0.35	1.95	2.90	1.91	105
280	420	106	94	5	1.5	1 260	1 970	106	570	760	46256 46256A 46356 46356A	302	395	6	4	1.5	0.33	2.03	3.02	1.98	46.9
	420	133	106	5	1.5	1 570	2 610	139	570	760		302	394	13.5	4	1.5	0.33	2.03	3.02	1.98	58.9
	460	146	130	6	2	1 950	2 930	154	530	700		308	430	8	5	2	0.35	1.95	2.90	1.91	90.0
	460	183	146	6	2	2 470	3 940	203	520	690		308	434	18.5	5	2	0.35	1.95	2.90	1.91	111
300	460	118	105	5	1.5	1 630	2 400	127	500	670	46260 46260A 46360 46360A	322	436	6.5	4	1.5	0.32	2.12	3.15	2.07	64.6
	460	148	118	5	1.5	2 050	3 230	165	510	680		322	433	15	4	1.5	0.32	2.12	3.15	2.07	80.2
	500	160	142	6	2	2 320	3 540	183	470	620		328	469	9	5	2	0.35	1.95	2.90	1.91	116
	500	200	160	6	2	2 860	4 630	231	470	630		328	466	20	5	2	0.35	1.95	2.90	1.91	144

[Remark] Bearings not shown above (e.g. inch series) are shown in catalog "large size ball & roller bearings".

Double-row tapered roller bearings
TDO type

d (300) ~420 mm

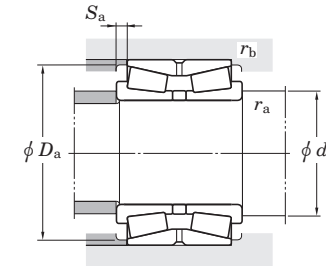
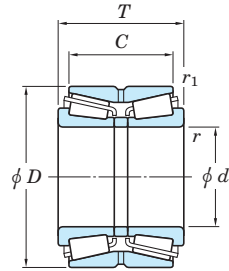

Boundary dimensions (mm)						Basic load ratings (kN)		Fatigue load limit (kN)	Limiting speeds (min ⁻¹)		Bearing No.	Mounting dimensions (mm)					Constant e	Axial load factors			(Refer.) Mass (kg)
d	D	T	C	$r_{min.}$	$r_{1 min.}$	C_r	C_{Or}	C_u	Grease lub.	Oil lub.		$d_a min.$	$D_a min.$	$S_a min.$	$r_a max.$	$r_b max.$		Y_2	Y_3	Y_0	
300	500	200	160	6	1.5	3 140	4 650	237	—	—	46360D	328	475	20	5	1.5	0.40	1.68	2.50	1.64	139
320	480	121	108	5	1.5	1 800	2 700	142	480	640	46264	342	452	6.5	4	1.5	0.32	2.12	3.15	2.07	71.6
	480	151	121	5	1.5	2 060	3 410	171	470	630	46264A	342	454	15	4	1.5	0.32	2.12	3.15	2.07	87.7
	540	176	157	6	2	2 880	4 570	228	420	560	46364	348	502	9.5	5	2	0.35	1.95	2.90	1.91	154
	540	220	176	6	2	3 280	5 390	264	430	570	46364A	348	497	22	5	2	0.35	1.95	2.90	1.91	190
340	520	133	118	6	2	1 940	3 070	157	420	570	46268	368	489	7.5	5	2	0.32	2.12	3.15	2.07	95.3
	520	165	133	6	2	2 420	4 060	203	420	560	46268A	368	491	16	5	2	0.32	2.12	3.15	2.07	117
	580	190	169	6	2	2 980	4 620	227	380	510	46368	368	539	10.5	5	2	0.35	1.95	2.90	1.91	198
	580	238	190	6	2	3 820	6 340	303	370	500	46368A	368	543	24	5	2	0.35	1.95	2.90	1.91	244
360	540	134	120	6	2	2 070	3 290	166	400	530	46272	388	510	7	5	2	0.32	2.12	3.15	2.07	93.0
	540	169	134	6	2	2 530	4 230	210	390	530	46272A	388	512	17.5	5	2	0.32	2.12	3.15	2.07	124
	600	192	171	6	2	3 600	4 880	264	360	480	46372	388	557	10.5	5	2	0.35	1.95	2.90	1.91	206
	600	240	192	6	2	4 590	7 230	345	360	480	46372A	388	568	24	5	2	0.39	1.74	2.59	1.70	254
380	560	135	122	6	2	2 190	3 560	177	370	500	46276	408	530	6.5	5	2	0.32	2.12	3.15	2.07	100
	560	171	135	6	2	2 810	4 670	228	380	500	46276A	408	531	18	5	2	0.39	1.74	2.59	1.70	129
	620	194	173	6	2	3 380	5 220	250	340	450	46376	408	582	10.5	5	2	0.39	1.74	2.59	1.70	215
	620	243	194	6	2	4 390	7 360	342	330	440	46376A	408	587	24.5	5	2	0.35	1.95	2.90	1.91	265
400	600	148	132	6	2	2 350	3 720	183	340	460	46280	428	560	8	5	2	0.32	2.12	3.15	2.07	135
	600	185	148	6	2	3 030	5 150	245	340	460	46280A	428	563	18.5	5	2	0.32	2.12	3.15	2.07	167
	650	200	178	6	3	3 740	5 920	283	320	420	46380	428	605	11	5	2.5	0.35	1.95	2.90	1.91	243
	650	250	200	6	3	5 110	8 850	406	310	420	46380A	428	610	25	5	2.5	0.35	1.95	2.90	1.91	306
420	620	150	134	6	2	2 520	4 130	200	320	420	46284	448	590	8	5	2	0.33	2.03	3.02	1.98	142
	620	188	150	6	2	3 390	5 660	267	320	430	46284A	448	589	19	5	2	0.39	1.74	2.59	1.70	176
	700	224	200	6	3	4 650	6 880	324	290	380	46384	448	656	12	5	2.5	0.39	1.74	2.59	1.70	325
	700	280	224	6	3	6 040	9 620	430	290	380	46384A	448	659	28	5	2.5	0.39	1.74	2.59	1.70	400

[Remark] Bearings not shown above (e.g. inch series) are shown in catalog "large size ball & roller bearings".

Double-row tapered roller bearings
TDO type

d 440 ~ 500 mm

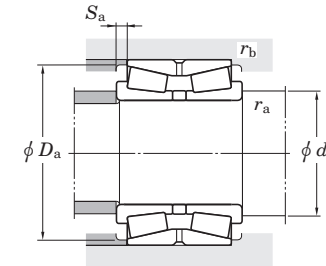
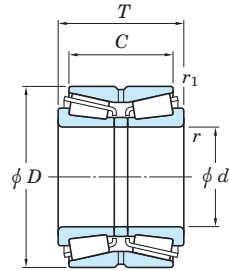

d	Boundary dimensions (mm)				Basic load ratings (kN)		Fatigue load limit (kN) C _u	Limiting speeds (min ⁻¹)		Bearing No.	Mounting dimensions (mm)					Constant e	Axial load factors			(Refer.) Mass (kg)	
	D	T	C	r _{min.}	r _{1 min.}	C _r		C _{0r}	Grease lub.		Oil lub.	d _{a min.}	D _{a min.}	S _{a min.}	r _{a max.}		r _{b max.}	Y ₂	Y ₃		Y ₀
440	650	157	140	6	3	2 840	4 430	212	300	390	46288 46288A 46388 46388A	468	622	8.5	5	2.5	0.33	2.03	3.02	1.98	156
	650	196	157	6	3	3 770	6 370	300	300	400		468	620	19.5	5	2.5	0.39	1.74	2.59	1.70	198
	720	226	201	6	3	4 950	8 110	372	270	360		468	676	12.5	5	2.5	0.39	1.74	2.59	1.70	354
	720	283	226	6	3	6 210	10 100	447	270	360		468	679	28.5	5	2.5	0.40	1.68	2.51	1.65	418
460	680	163	145	6	3	3 130	5 340	253	280	370	46292 46292A 46392 46392A	488	637	9	5	2.5	0.37	1.83	2.72	1.78	196
	680	204	163	6	3	4 040	6 850	317	280	370		488	646	20.5	5	2.5	0.39	1.74	2.59	1.70	232
	760	240	214	7.5	4	5 460	9 000	408	250	330		496	710	13	6	3	0.39	1.74	2.59	1.70	424
	760	300	240	7.5	4	7 130	11 600	504	250	330		496	718	30	6	3	0.39	1.74	2.59	1.70	506
480	700	165	147	6	3	3 180	5 300	247	260	340	46296 46296A 46396 46396A	508	672	9	5	2.5	0.33	2.03	3.02	1.98	186
	700	206	165	6	3	4 040	7 230	333	260	340		508	666	20.5	5	2.5	0.33	2.03	3.02	1.98	240
	790	248	221	7.5	4	5 820	8 920	405	230	310		516	742	13.5	6	3	0.39	1.74	2.59	1.70	457
	790	310	248	7.5	4	7 530	12 400	528	230	310		516	749	31	6	3	0.39	1.74	2.59	1.70	560
500	720	167	149	6	3	3 230	5 690	265	250	330	462/500 462/500A 463/500 463/500A	528	679	9	5	2.5	0.40	1.71	2.54	1.67	210
	720	209	167	6	3	4 390	7 850	356	250	330		528	690	21	5	2.5	0.42	1.62	2.41	1.58	258
	830	264	235	7.5	4	6 570	10 900	477	210	280		536	776	14.5	6	3	0.39	1.74	2.59	1.70	559
	830	330	264	7.5	4	8 510	14 000	586	210	280		536	784	33	6	3	0.39	1.74	2.59	1.70	669

[Remark] Bearings not shown above (e.g. inch series) are shown in catalog "large size ball & roller bearings".

Double-row tapered roller bearings

TDI type

d 100 ~ (220) mm

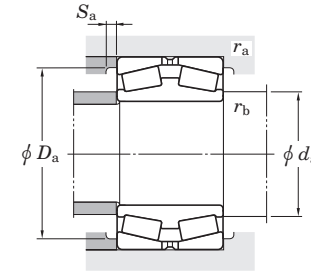
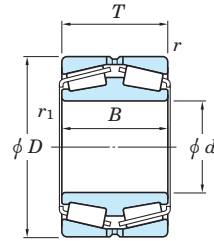

Boundary dimensions (mm)						Basic load ratings (kN)		Fatigue load limit (kN)	Limiting speeds (min ⁻¹)		Bearing No.	Mounting dimensions (mm)					Constant e	Axial load factors			(Refer.) Mass (kg)	
d	D	B	T	$r_{min.}$	$r1_{min.}$	C_r	C_{0r}	C_u	Grease lub.	Oil lub.		d_a max.	D_a max.	S_a min.	r_a max.	r_b max.		Y_2	Y_3	Y_0		
100	165	52	52	2	2.5	298	384	28.0	1 800	2 300	45320	119	155	148	3.9	2	2	0.35	1.95	2.90	1.91	4.26
110	180	56	56	2	2.5	378	505	36.1	1 600	2 100	45322	128	170	160	4	2	2	0.35	1.95	2.90	1.91	5.40
120	180	46	46	2	2.5	286	424	29.7	1 500	2 100	45224	138	170	163	4	2	2	0.26	2.55	3.80	2.50	4.08
	200	62	62	2	2.5	444	598	41.7	1 400	1 900	45324	142	190	178	4	2	2	0.35	1.95	2.90	1.91	7.92
130	200	52	52	2	2.5	376	548	37.8	1 400	1 800	45226	152	190	179	4	2	2	0.27	2.47	3.67	2.41	5.96
	210	64	64	2	2.5	476	657	45.2	1 300	1 800	45326	153	200	185	4	2	2	0.36	1.87	2.79	1.83	8.41
140	210	53	53	2	2.5	390	564	38.5	1 300	1 800	45228	159	200	188	4	2	2	0.27	2.47	3.67	2.41	6.45
	225	68	68	2.5	3	611	807	51.3	1 200	1 700	45328	160	213	210	4	2	2.5	0.40	1.68	2.50	1.64	10.0
150	225	56	56	2.5	3	445	686	45.8	1 200	1 600	45230	174	213	203	4	2	2.5	0.26	2.55	3.80	2.50	7.87
	250	80	80	2.5	3	684	955	59.8	1 100	1 500	45330	179	238	220	4	2	2.5	0.35	1.95	2.90	1.91	15.5
160	240	60	60	2.5	3	488	705	46.6	1 100	1 500	45232	184	228	217	5	2	2.5	0.24	2.79	4.15	2.73	9.22
	270	86	86	2.5	3	832	1 100	73.2	1 000	1 400	45332	193	258	237	4	2	2.5	0.35	1.95	2.90	1.91	19.8
170	260	67	67	2.5	3	654	956	62.1	1 000	1 400	45234	195	248	233	5	2	2.5	0.31	2.21	3.29	2.16	12.4
	280	88	88	2.5	3	834	1 210	72.7	970	1 300	45334	201	268	247	5	2	2.5	0.33	2.03	3.02	1.98	21.6
180	280	74	74	2.5	3	722	1 050	62.5	950	1 300	45236	208	268	250	5	2	2.5	0.28	2.43	3.61	2.37	16.8
	300	96	96	3	4	992	1 370	81.2	910	1 200	45336	210	286	263	5	2.5	3	0.35	1.95	2.90	1.91	26.5
190	290	75	75	2.5	3	751	1 130	66.3	900	1 200	45238	219	278	260	5	2	2.5	0.26	2.55	3.80	2.50	17.7
	320	104	104	3	4	1 130	1 590	91.3	840	1 100	45338	224	306	280	5	2.5	3	0.35	1.95	2.90	1.91	34.0
200	310	82	82	2.5	3	913	1 410	83.1	830	1 100	45240	234	298	280	5	2	2.5	0.26	2.55	3.80	2.50	22.9
	340	112	112	3	4	1 250	1 840	104	770	1 000	45340	244	326	300	5	2.5	3	0.35	1.95	2.90	1.91	41.9
220	340	90	90	3	4	933	1 460	83.4	740	990	45244	259	326	306	5	2.5	3	0.28	2.43	3.61	2.37	28.5

[Remark] Bearings not shown above (e.g. inch series) are shown in catalog "large size ball & roller bearings".

Double-row tapered roller bearings

TDI type

d (220) ~ (420) mm

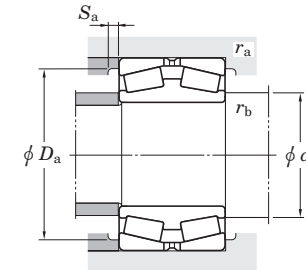
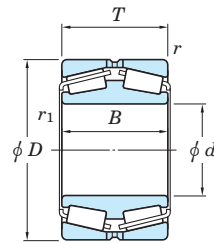

Boundary dimensions (mm)						Basic load ratings (kN)		Fatigue load limit (kN)	Limiting speeds (min ⁻¹)		Bearing No.	Mounting dimensions (mm)					Constant e	Axial load factors			(Refer.) Mass (kg)	
d	D	B	T	$r_{min.}$	$r_{1 min.}$	C_r	C_{0r}	C_u	Grease lub.	Oil lub.		d_a max.	D_a max.	D_a min.	S_a min.	r_a max.		r_b max.	Y_2	Y_3		Y_0
220	370	120	120	4	5	1 400	2 060	113	700	930	45344	263	352	324	5	3	4	0.35	1.95	2.90	1.91	50.8
230	350	90	90	3	4	991	1 560	88.6	710	950	45246	267	336	318	6	2.5	3	0.28	2.43	3.61	2.37	30.6
240	360	92	92	3	4	1 150	1 790	99.8	690	920	45248	271	346	325	5	2.5	3	0.32	2.12	3.15	2.07	32.2
	400	128	128	4	5	1 650	2 470	133	630	840	45348	286	382	354	5	3	4	0.35	1.95	2.90	1.91	65.4
260	400	104	104	4	5	1 320	2 120	113	610	810	45252	302	382	360	6	3	4	0.25	2.74	4.08	2.68	48.1
	440	144	144	4	5	2 180	3 440	179	560	750	45352	313	422	386	6	3	4	0.35	1.95	2.90	1.91	92.2
280	420	106	106	4	5	1 490	2 470	133	560	750	45256	321	402	370	6	3	4	0.25	2.69	4.00	2.63	51.9
	460	146	146	5	6	2 310	3 320	175	520	700	45356	323	438	409	6	4	5	0.39	1.74	2.59	1.70	93.1
300	460	118	118	4	5	1 870	3 150	162	500	670	45260	350	442	418	6	3	4	0.25	2.74	4.08	2.68	78.5
	500	160	160	5	6	2 670	4 240	216	470	630	45360	356	478	440	6	4	5	0.35	1.95	2.90	1.91	129
320	480	121	121	4	5	1 830	3 180	161	470	630	45264	368	462	434	6	3	4	0.26	2.55	3.80	2.50	77.8
	540	176	176	5	6	3 380	5 280	264	430	570	45364R	378	518	474	6	4	5	0.32	2.12	3.15	2.07	167
340	520	133	133	5	6	2 380	3 850	186	420	570	45268	398	498	464	6	4	5	0.26	2.55	3.80	2.50	104
	580	190	190	5	6	3 790	5 470	269	390	510	45368	401	558	515	6	4	5	0.32	2.12	3.15	2.07	202
360	540	134	134	5	6	2 370	3 910	196	400	540	45272	408	518	488	11	4	5	0.32	2.12	3.15	2.07	101
	600	192	192	5	6	4 230	6 750	324	360	490	45372	419	578	528	10	4	5	0.32	2.12	3.15	2.07	228
380	560	135	135	5	6	2 300	3 790	185	380	500	45276	428	538	510	6	4	5	0.27	2.47	3.67	2.41	112
	620	194	194	5	6	3 860	6 360	303	340	450	45376	445	598	545	6	4	5	0.32	2.12	3.15	2.07	234
400	600	148	148	5	6	3 020	4 960	239	340	450	45280	452	578	545	6	4	5	0.33	2.03	3.02	1.98	143
	650	200	200	6	6	4 840	7 810	368	320	420	45380	458	622	580	11	5	5	0.39	1.74	2.59	1.70	265
420	620	150	150	5	6	3 010	5 200	248	320	430	45284	475	598	564	6	4	5	0.33	2.03	3.02	1.98	152

[Remark] Bearings not shown above (e.g. inch series) are shown in catalog "large size ball & roller bearings".

Double-row tapered roller bearings
TDI type

d (420) ~ 500 mm

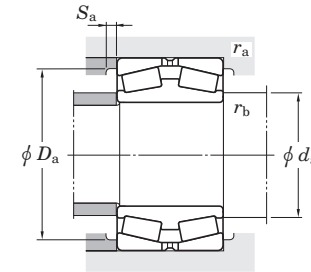
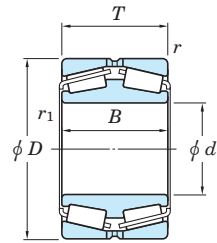

d	Boundary dimensions (mm)					Basic load ratings (kN)		Fatigue load limit (kN) C_u	Limiting speeds (min^{-1})		Bearing No.	Mounting dimensions (mm)					Constant e	Axial load factors			(Refer.) Mass (kg)	
	D	B	T	$r_{\text{min.}}$	$r_{1\text{ min.}}$	C_r	C_{0r}		Grease lub.	Oil lub.		$d_{a\text{ max.}}$	$D_{a\text{ max.}}$	$D_{a\text{ min.}}$	$S_{a\text{ min.}}$	$r_{a\text{ max.}}$		$r_{b\text{ max.}}$	Y_2	Y_3		Y_0
420	700	224	224	6	6	5 430	8 380	389	280	380	45384	488	672	623	7	5	5	0.39	1.74	2.59	1.70	352
440	650	157	157	6	6	3 190	5 500	256	300	390	45288	500	622	592	10	5	5	0.28	2.43	3.61	2.37	182
	720	226	226	6	6	5 750	9 130		417	270		360	45388	506	692	642	7		5	5	0.39	
460	680	163	163	6	6	3 480	5 660	265	280	370	45292	510	652	616	6	5	5	0.39	1.74	2.59	1.70	197
	760	240	240	7.5	7.5	6 570	10 400		463	250		330	45392	532	724	677	7		6	6	0.39	
480	700	165	165	6	6	3 830	6 710	307	260	350	45296	531	672	625	6	5	5	0.40	1.68	2.50	1.64	215
500	720	167	167	6	6	4 300	7 350	340	250	330	452/500	545	692	645	8	5	5	0.39	1.74	2.59	1.70	222
	830	264	264	7.5	7.5	7 970	12 300		555	210		280	453/500	587	794	729	7		6	6	0.33	

[Remark] Bearings not shown above (e.g. inch series) are shown in catalog "large size ball & roller bearings".

Spherical roller bearings

Spherical roller bearings feature a large load rating capacity and self-aligning capability.

This type of bearing is suitable for low- or medium-speed applications which involve heavy or impact loading.

- These bearings are divided into R(RR), RZ and RHA types, which differ in internal structure. (refer to Table 1.)
- Each type can be produced with a cylindrical bore or tapered bore.

Bearings with a tapered bore can be fit and removed easily using an adapter assembly or withdrawal sleeve.

The rate of taper is equivalent among all bearing series.

240 and 241 series ... 1 : 30 (supplementary code "K30")

Others ... 1 : 12 (supplementary code "K")

Spherical roller bearings



Cylindrical bore Tapered bore

Bore diameter **25 – 500 mm**

Adapter assemblies

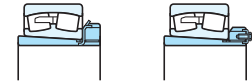

Bore diameter **20 – 470 mm**

Withdrawal sleeves



Bore diameter **35 – 480 mm**

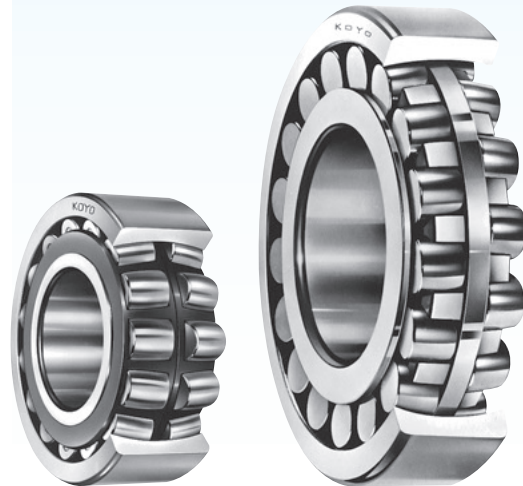



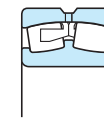

Table 1 Spherical roller bearings : types and structures

Structure	 R, RR type	 RZ type	 RHA type
Roller	Convex asymmetrical roller	Convex symmetrical roller	Convex symmetrical roller
Cage	Copper alloy prong type machined cage	Pressed cage	Copper alloy integral type machined cage
Inner ring (with or without rib)	With center rib	Without center rib (guide ring)	Without center rib (guide ring)
	With ribs on both sides (to prevent rollers from falling)	Without ribs on both sides	With ribs on both sides (to prevent rollers from falling)
Characteristics	Excellent high-speed properties	Excellent high-speed properties Large load rating capacity Usable at high temperatures (up to 200°C)	Large load rating capacity

■ Spherical roller bearings for shaker screens



- These bearings consist of convex asymmetric rollers and a prong type, copper alloy, outer ring guided, machined cage. This cage possesses optimum characteristics for use with shaker screens.

- The bearings most commonly used with shaker screens are 223 series spherical roller bearings. They are identified by the supplementary code "ROVS W502." The outer ring outside diameter tolerance of these bearings is held to a small allowable variation.

■ Bearings with lubrication holes and a lubrication groove

- Outer rings can be provided with lubrication holes, a lubrication groove and an anti-rotation pin hole. (Specifications are given in Table 4.)
- Inner rings can also be provided with lubrication holes and a lubrication groove.

Table 2 Supplementary codes for identification of bearings with lubrication holes, lubrication groove and anti-rotation pin hole (outer ring)

Supplementary code		Number of lubrication holes	Hole layout
With lubrication holes and lubrication groove	With lubrication holes, lubrication groove and anti-rotation pin hole		
W33	W3N	3 ¹⁾	3 equally spaced positions ¹⁾
W33A	W3NA	4	4 equally spaced positions
-	W3NB	5	6 equally spaced positions ²⁾
W33C	W3NC	6	6 equally spaced positions
-	W3ND	7	8 equally spaced positions ²⁾
W33T	-	8	8 equally spaced positions

[Notes] 1) Also 4 or 6 holes are provided in smaller size bearings, consult with JTEKT.
 2) One hole is used for the antirotation pin.

[Remark] Boldfaced codes indicate JTEKT standards.

Table 3 Supplementary codes for identification of bearings with lubrication holes and/or lubrication groove

Supplementary code	Inner ring		Outer ring	
	Number of lubrication holes	Lubrication groove	Number of lubrication holes	Lubrication groove
W513	3	-	3	○
W518	3	-	3	-
W26	3	-	-	-

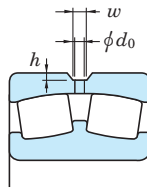

Table 4 (1) Lubrication hole and lubrication groove dimensions Unit : mm

Bore diameter number	Nominal bore diameter <i>d</i>	239			230			240			231			241			222			232			213			223			
		<i>d</i> ₀	<i>w</i>	<i>h</i>	<i>d</i> ₀	<i>w</i>	<i>h</i>	<i>d</i> ₀	<i>w</i>	<i>h</i>	<i>d</i> ₀	<i>w</i>	<i>h</i>	<i>d</i> ₀	<i>w</i>	<i>h</i>	<i>d</i> ₀	<i>w</i>	<i>h</i>	<i>d</i> ₀	<i>w</i>	<i>h</i>	<i>d</i> ₀	<i>w</i>	<i>h</i>	<i>d</i> ₀	<i>w</i>	<i>h</i>	
5	25	-	-	-	-	-	-	-	-	-	-	-	-	-	-	-	3	4	0.7	-	-	-	-	-	-	-	-	-	-
6	30	-	-	-	-	-	-	-	-	-	-	-	-	-	-	-	3	4	0.7	-	-	-	-	3	4	0.7	4	6	1
7	35	-	-	-	-	-	-	-	-	-	-	-	-	-	-	-	3	4	0.8	-	-	-	-	3	4	0.7	3	4	1
8	40	-	-	-	-	-	-	-	-	-	-	-	-	-	-	-	3	4	0.8	-	-	-	-	3	4	0.7	4	5	1
9	45	-	-	-	-	-	-	-	-	-	-	-	-	-	-	-	3	4	0.8	-	-	-	-	3	4	0.7	4	6	1
10	50	-	-	-	-	-	-	-	-	-	-	-	-	-	-	-	3	4	0.8	-	-	-	-	3	4	0.7	4	6	1
11	55	-	-	-	-	-	-	-	-	-	-	-	-	-	-	-	3	4	0.8	-	-	-	-	3	4	0.7	4	6	1.1
12	60	-	-	-	-	-	-	-	-	-	-	-	-	-	-	-	3	4	1	-	-	-	-	3	4	1	4	6	1.1
13	65	-	-	-	-	-	-	-	-	-	-	-	-	-	-	-	3	4	1	-	-	-	-	3	4	1	4	6	1.2
14	70	-	-	-	-	-	-	-	-	-	-	-	-	-	-	-	3	4	1	-	-	-	-	3	4	1	5	7	1.3
15	75	-	-	-	-	-	-	-	-	-	-	-	-	-	-	-	3	4	1	-	-	-	-	3	4	1	5	7	1.3
16	80	-	-	-	-	-	-	-	-	-	-	-	-	-	-	-	3	4	1	4	6	1.2	4	6	1	5	7	1.3	
17	85	-	-	-	-	-	-	-	-	-	-	-	-	-	-	-	4	5	1	4	6	1.2	4	6	1.2	6	8	1.3	
18	90	-	-	-	-	-	-	-	-	-	-	-	-	-	-	-	4	5	1	4	5	8	1.2	4	6	1.2	6	8	1.3
19	95	-	-	-	-	-	-	-	-	-	-	-	-	-	-	-	5	6	1.2	5	8	1.2	4	6	1.2	6	8	2	
20	100	-	-	-	4	5	1	-	-	-	-	5	6	1.4	-	-	5	6	1.2	5	8	1.2	4	6	1.2	6	8	2	
22	110	-	-	-	5	7	1	-	-	-	5	6	1.4	6	8	1.5	5	7	1.5	6	8	1.7	4	6	1.2	6	8	2	
24	120	-	-	-	5	7	1	5	6	1.4	5	6	1.4	6	8	1.5	5	7	1.5	6	10	1.7	-	-	-	8	10	2.5	
26	130	-	-	-	5	7	1.2	6	8	1.5	5	6	1.5	6	8	1.5	5	7	1.5	6	10	1.7	-	-	-	8	12	2.5	
28	140	4	5	1	5	7	1.2	6	8	1.5	6	8	1.5	8	10	2	6	8	1.8	8	10	2.5	-	-	-	12	14	3	
30	150	5	7	1	5	8	1.2	6	8	1.5	6	10	1.5	8	10	2	6	10	1.8	8	10	2.5	-	-	-	12	14	3	
32	160	5	7	1.2	5	8	1.2	6	8	1.5	8	12	2	10	12	2	10	12	2	10	12	2.5	-	-	-	12	14	3	
34	170	5	7	1.2	6	10	1.5	8	10	2	8	12	2	10	12	2	12	14	3	10	12	2.5	-	-	-	12	14	3	
36	180	6	7	1.3	8	12	1.5	10	12	2.5	10	12	2.5	10	12	2	12	14	3	10	12	2.5	-	-	-	14	16.5	4	
38	190	5	7	1.2	10	12	2.5	10	12	2.5	10	12	2.5	10	12	2	12	14	3	12	14	3	-	-	-	14	16.5	4	
40	200	6	8	1.5	10	12	2.5	10	12	2.5	12	14	3	12	14	3	12	14	3	12	14	3	-	-	-	14	16.5	4	
44	220	6	8	1.5	10	12	2.5	10	12	2.5	12	14	3	12	14	3	12	14	3	12	14	3	-	-	-	14	16.5	4	
48	240	6	8	1.5	10	12	2.5	10	12	2.5	12	14	3	12	14	3	14	16.5	4	14	16.5	4	-	-	-	14	16.5	4	
52	260	10	12	2.5	12	14	3	12	14	3	12	14	3	12	14	3	14	16.5	4	14	16.5	4	-	-	-	14	16.5	4	
56	280	10	12	2.5	12	14	3	12	14	3	12	14	3	12	14	3	14	16.5	4	14	16.5	4	-	-	-	14	16.5	4	
60	300	10	12	2.5	12	14	3	12	14	3	12	14	3	12	14	3	14	16.5	4	14	16.5	4	-	-	-	14	16.5	4	
64	320	10	12	2.5	12	14	3	12	14	3	14	16.5	4	14	16.5	4	14	16.5	4	14	16.5	4	-	-	-	14	16.5	4	
68	340	12	14	3	14	16.5	4	14	16.5	4	14	16.5	4	14	16.5	4	14	16.5	4	14	16.5	4	-	-	-	14	16.5	4	
72	360	12	14	3	14	16.5	4	14	16.5	4	14	16.5	4	14	16.5	4	14	16.5	4	14	16.5	4	-	-	-	14	16.5	4	

Table 4 (2) Lubrication hole and lubrication groove dimensions Unit : mm

Bore diameter number	Nominal bore diameter <i>d</i>	239			230			240			231			241			222			232			213			223		
		<i>d</i> ₀	<i>w</i>	<i>h</i>	<i>d</i> ₀	<i>w</i>	<i>h</i>	<i>d</i> ₀	<i>w</i>	<i>h</i>	<i>d</i> ₀	<i>w</i>	<i>h</i>	<i>d</i> ₀	<i>w</i>	<i>h</i>	<i>d</i> ₀	<i>w</i>	<i>h</i>	<i>d</i> ₀	<i>w</i>	<i>h</i>	<i>d</i> ₀	<i>w</i>	<i>h</i>	<i>d</i> ₀	<i>w</i>	<i>h</i>
76	380	12	14	3	14	16.5	4	14	16.5	3	14	16.5	4	14	16.5	4	-	-	-	14	16.5	4	-	-	-	14	16.5	4
80	400	12	14	3	14	16.5	4	14	16.5	4	14	16.5	4	14	16.5	4	-	-	-	14	16.5	4	-	-	-	14	16.5	4
84	420	12	14	3	14	16.5	4	14	16.5	4	14	16.5	4	14	16.5	4	-	-	-	14	16.5	4	-	-	-	14	16.5	4
88	440	14	16.5	4	14	16.5	4	14	16.5	4	14	16.5	4	14	16.5	4	-	-	-	14	16.5	4	-	-	-	14	16.5	4
92	460	14	16.5	4	14	16.5	4	14	16.5	4	14	16.5	4	14	16.5	4	-	-	-	14	16.5	4	-	-	-	14	16.5	4
96	480	14	16.5	4	14	16.5	4	14	16.5	4	14	16.5	4	14	16.5	4	-	-	-	14	16.5	4	-	-	-	14	16.5	4
/500	500	14	16.5	4	14	16.5	4	14	16.5	4	14	16.5	4	14	16.5	4	-	-	-	14	16.5	4	-	-	-	14	16.5	4

Boundary dimensions	As specified in JIS B 1512.
Tolerances	As specified in JIS B 1514-1, class 0. (refer to Table 7-3 on pp. A 60 – A 63.) Refer to Table 7-11 on p. A 76 for the tolerance of tapered bores.
Radial internal clearance	As specified in JIS B 1520. (refer to Table 10-9 on p. A 108.)
Recommended fits	Refer to Table 9-4 on pp. A 91, 92.
Standard cages	Refer to Table 5.
Allowable aligning angle	Refer to Table 5. (varies depending on bearing series.)
Equivalent radial load	Dynamic equivalent radial load $\left(\text{When } \frac{F_a}{F_r} \leq e \right) P_r = F_r + Y_1 F_a \quad \left(\text{When } \frac{F_a}{F_r} > e \right) P_r = 0.67F_r + Y_2 F_a$ Static equivalent radial load $P_{0r} = F_r + Y_0 F_a$ [Note] Refer to the specification table for the values of axial load factors Y_1 , Y_2 and Y_0 and of constant e .

[Remark] If the ratio of axial load to radial load exceeds the value e given in the specification table ($F_a/F_r > e$), slippage occurs between rollers in rows that are not axial-loaded and the raceway. This may cause smearing, especially when the bearing is large. Consult with JTEKT on the use of bearings under such conditions.

Table 5 Application of standard cages and allowable aligning angle

Bearing series	Standard cages		Allowable aligning angle
	Pressed cage	Machined cage	
239 R	—	23930R – 239/500R	0.026 rad (1.5°)
230 R	—	23038R – 230/500R	
RZ	23020RZ – 23036RZ	—	0.026 rad (1.5°)
RHA	—	23038RHA – 23096RHA	
240 R(RR)	—	24036RR – 240/500R	0.035 rad (2°)
RZ	24022RZ – 24034RZ	—	
RHA	—	24038RHA – 24096RHA	
231 R	—	23136R – 231/500R	0.026 rad (1.5°)
RZ	23120RZ – 23134RZ	—	
RHA	—	23136RHA – 23196RHA	
241 R(RR)	—	24132RR – 241/500R	0.044 rad (2.5°)
RZ	24122RZ – 24130RZ	—	
RHA	—	24136RHA – 24196RHA	
222 R(RR)	—	22232RR – 222/500R	0.026 rad (1.5°)
RZ	22205RZ – 22230RZ	—	
RHA	—	22232RHA – 22260RHA	
232 R	—	23232R – 232/500R	0.044 rad (2.5°)
RZ	23216RZ – 23230RZ	—	
RHA	—	23232RHA – 23296RHA	
213 R	—	—	0.017 rad (1°)
RZ	21306RZ – 21322RZ	—	
223 R(RR)	—	22330R – 223/600R	0.035 rad (2°)
RZ	22308RZ – 22326RZ	—	
RHA	—	22330RHA – 22356RHA	

Spherical roller bearings

d 25 ~ 70 mm

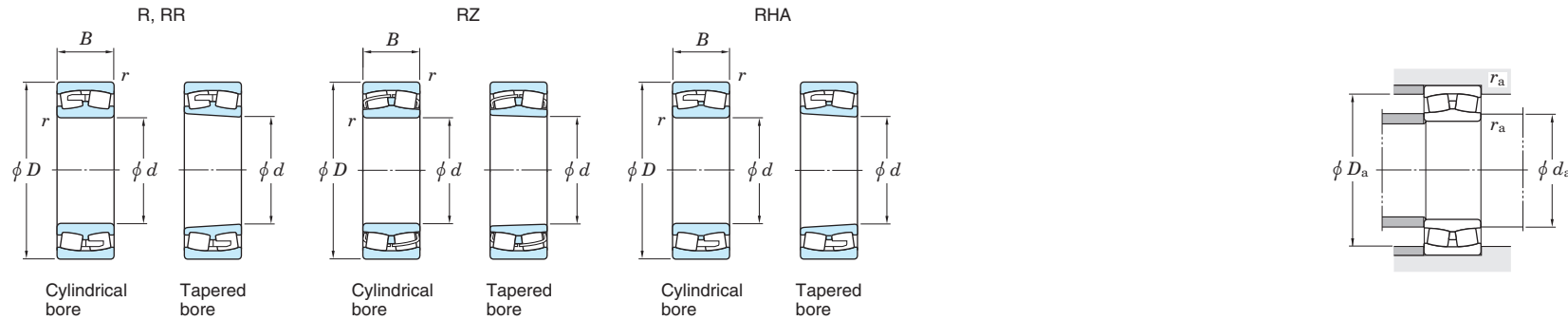

Boundary dimensions (mm)				Basic load ratings (kN)		Fatigue load limit (kN)	Limiting speeds (min ⁻¹)		Bearing No.		Mounting dimensions (mm)					Constant	Axial load factors			(Refer.) Mass (kg)	
d	D	B	r min.	C _r	C _{0r}	C _u	Grease lub.	Oil lub.	Cylindrical bore	Tapered bore	d _a min.	d _a max.	D _a max.	D _a min.	r _a max.	e	Y ₁	Y ₂	Y ₀	Cylindrical bore	Tapered bore
25	52	18	1	56.8	48.1	3.90	9 600	12 800	22205RZ	22205RZK	31	31	46	46	1	0.35	1.91	2.85	1.87	0.188	0.184
30	62	20	1	76.6	65.9	5.30	8 100	10 900	22206RZ	22206RZK	36	36.5	56	55.5	1	0.33	2.04	3.04	2.00	0.296	0.290
	72	19	1.1	74.2	62.7	4.80	7 200	9 600	21306RZ	21306RZK	37	41.5	65	61.5	1	0.27	2.49	3.71	2.43	0.430	0.424
35	72	23	1.1	100	88.7	7.75	6 900	9 200	22207RZ	22207RZK	42	42.5	65	64	1	0.32	2.09	3.11	2.04	0.459	0.449
	80	21	1.5	86.8	75.8	5.90	6 200	8 300	21307RZ	21307RZK	43.5	46.5	71.5	68.5	1.5	0.27	2.49	3.71	2.43	0.572	0.564
40	80	23	1.1	114	102	9.55	6 200	8 300	22208RZ	22208RZK	47	49	73	72.5	1	0.28	2.37	3.53	2.32	0.602	0.591
	90	23	1.5	105	95.5	7.55	5 600	7 600	21308RZ	21308RZK	48.5	53.5	81.5	77	1.5	0.26	2.55	3.80	2.50	0.781	0.770
	90	33	1.5	170	152	11.8	5 600	7 600	22308RZ	22308RZK	48.5	51	81.5	78.5	1.5	0.37	1.83	2.72	1.79	1.08	1.06
45	85	23	1.1	119	110	10.2	5 800	7 700	22209RZ	22209RZK	52	53.5	78	77.5	1	0.26	2.55	3.80	2.50	0.602	0.590
	100	25	1.5	132	124	9.95	5 000	6 700	21309RZ	21309RZK	53.5	60	91.5	86	1.5	0.26	2.62	3.90	2.56	1.05	1.04
	100	36	1.5	208	183	13.8	5 100	6 700	22309RZ	22309RZK	53.5	55.5	91.5	87	1.5	0.37	1.83	2.72	1.79	1.42	1.39
50	90	23	1.1	128	122	12.7	5 400	7 200	22210RZ	22210RZK	57	58.5	83	82.5	1	0.24	2.79	4.15	2.73	0.648	0.634
	110	27	2	157	151	12.0	4 500	6 100	21310RZ	21310RZK	60	67	100	94.5	2	0.25	2.71	4.04	2.65	1.37	1.35
	110	40	2	255	237	17.5	4 500	6 200	22310RZ	22310RZK	60	62.5	100	95.5	2	0.36	1.85	2.76	1.81	1.92	1.88
55	100	25	1.5	154	144	15.0	4 700	6 300	22211RZ	22211RZK	63.5	64	91.5	91.5	1.5	0.24	2.84	4.23	2.78	0.867	0.849
	120	29	2	180	165	13.0	4 100	5 600	21311RZ	21311RZK	65	71.5	110	101.5	2	0.25	2.71	4.03	2.65	1.69	1.67
	120	43	2	296	264	21.1	4 100	5 500	22311RZ	22311RZK	65	66	110	104	2	0.36	1.85	2.76	1.81	2.40	2.35
60	110	28	1.5	190	181	18.7	4 300	5 800	22212RZ	22212RZK	68.5	70	101.5	100	1.5	0.25	2.74	4.08	2.68	1.19	1.17
	130	31	2.1	210	193	15.1	3 900	5 100	21312RZ	21312RZK	72	77.5	118	110	2	0.24	2.78	4.14	2.72	2.11	2.08
	130	46	2.1	354	334	24.9	3 900	5 100	22312RZ	22312RZK	72	73.5	118	113	2	0.36	1.86	2.77	1.82	3.06	2.99
65	120	31	1.5	222	211	20.7	4 000	5 200	22213RZ	22213RZK	73.5	76	111.5	109	1.5	0.25	2.69	4.00	2.63	1.55	1.52
	140	33	2.1	242	232	19.8	3 600	4 700	21313RZ	21313RZK	77	85.5	128	119	2	0.24	2.83	4.21	2.76	2.62	2.58
	140	48	2.1	382	360	30.8	3 600	4 700	22313RZ	22313RZK	77	79.5	128	122	2	0.34	1.98	2.94	1.93	3.66	3.58
70	125	31	1.5	233	222	24.4	3 700	5 000	22214RZ	22214RZK	78.5	80	116.5	114	1.5	0.24	2.87	4.27	2.80	1.64	1.61
	150	35	2.1	268	260	21.6	3 300	4 400	21314RZ	21314RZK	82	91	138	126.5	2	0.24	2.84	4.23	2.78	3.19	3.15
	150	51	2.1	435	413	35.0	3 300	4 400	22314RZ	22314RZK	82	85.5	138	131	2	0.34	1.98	2.94	1.93	4.45	4.36

[Remark] Standard cage types used for the above bearings are shown in Table 5 earlier in this section.

Spherical roller bearings

d 75 ~ (110) mm

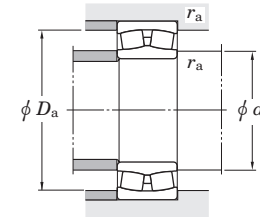
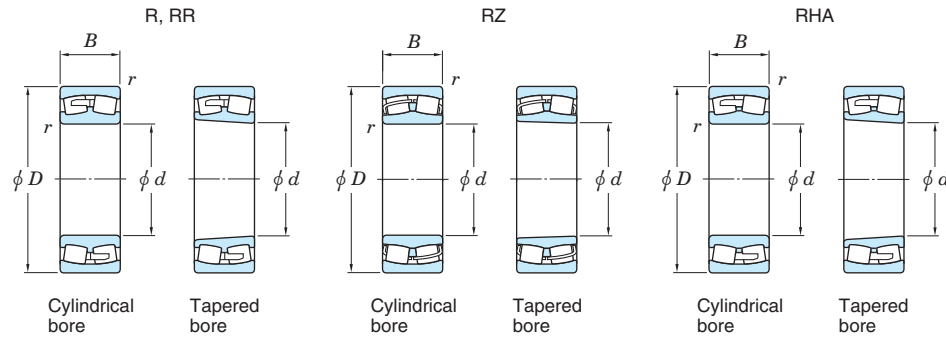

Boundary dimensions (mm)				Basic load ratings (kN)		Fatigue load limit (kN) C _u	Limiting speeds (min ⁻¹)		Bearing No.		Mounting dimensions (mm)					Constant e	Axial load factors			(Refer.) Mass (kg)	
d	D	B	r _{min.}	C _r	C _{0r}		Grease lub.	Oil lub.	Cylindrical bore	Tapered bore	d _a min.	d _a max.	D _a max.	D _a min.	r _a max.		Y ₁	Y ₂	Y ₀	Cylindrical bore	Tapered bore
75	130	31	1.5	241	236	28.2	3 600	4 700	22215RZ	22215RZK	83.5	85.5	121.5	119	1.5	0.22	3.07	4.57	3.00	1.73	1.69
	160	37	2.1	306	298	24.3	3 000	4 100	21315RZ	21315RZK	87	98	148	138	2	0.24	2.87	4.27	2.80	3.81	3.76
	160	55	2.1	492	473	38.4	3 000	4 100	22315RZ	22315RZK	87	91	148	139.5	2	0.35	1.95	2.90	1.91	5.45	5.33
80	140	33	2	271	271	30.5	3 300	4 400	22216RZ	22216RZK	90	92	130	128	2	0.22	3.07	4.57	3.00	2.17	2.13
	140	44.4	2	305	342	31.2	3 300	4 400	23216RZ	23216RZK	90	93	130	124	2	0.29	2.35	3.50	2.30	2.95	2.86
	170	39	2.1	344	339	27.5	2 900	3 900	21316RZ	21316RZK	92	104	158	146	2	0.23	2.88	4.29	2.82	4.53	4.47
	170	58	2.1	539	521	41.7	2 900	3 900	22316RZ	22316RZK	92	97	158	148	2	0.35	1.95	2.90	1.91	6.44	6.30
85	150	36	2	322	324	35.7	3 000	4 100	22217RZ	22217RZK	95	97	140	137	2	0.22	3.01	4.48	2.94	2.75	2.69
	150	49.2	2	358	410	36.2	3 000	4 100	23217RZ	23217RZK	95	99	140	134	2	0.30	2.25	3.34	2.20	3.78	3.67
	180	41	3	374	372	29.6	2 800	3 600	21317RZ	21317RZK	99	109	166	154	2.5	0.23	2.89	4.33	2.83	5.32	5.25
	180	60	3	601	586	47.8	2 800	3 600	22317RZ	22317RZK	99	103	166	157	2.5	0.33	2.02	3.00	1.97	7.47	7.31
90	160	40	2	372	381	39.2	2 900	3 900	22218RZ	22218RZK	100	104	150	145	2	0.24	2.79	4.15	2.73	3.50	3.43
	160	52.4	2	421	482	42.9	2 900	3 900	23218RZ	23218RZK	100	103	150	141	2	0.32	2.14	3.19	2.09	4.63	4.50
	190	43	3	413	416	32.9	2 600	3 400	21318RZ	21318RZK	104	116	176	162	2.5	0.23	2.91	4.30	2.84	6.20	6.11
	190	64	3	672	662	50.5	2 600	3 400	22318RZ	22318RZK	104	108	176	166	2.5	0.34	2.00	2.98	1.96	8.82	8.63
95	170	43	2.1	417	422	42.7	2 800	3 600	22219RZ	22219RZK	107	109	158	154	2	0.24	2.76	4.11	2.70	4.24	4.15
	170	55.6	2.1	457	516	43.9	2 800	3 600	23219RZ	23219RZK	107	110	158	150	2	0.30	2.25	3.34	2.20	5.50	5.35
	200	45	3	452	461	36.3	2 500	3 200	21319RZ	21319RZK	109	123	186	171	2.5	0.23	2.92	4.35	2.86	7.16	7.06
	200	67	3	733	726	55.6	2 500	3 200	22319RZ	22319RZK	109	114	186	174	2.5	0.33	2.02	3.00	1.97	10.2	9.98
100	150	37	1.5	262	332	33.7	2 900	3 900	23020RZ	23020RZK	109	110	141	138	1.5	0.22	3.01	4.48	2.94	2.34	2.27
	165	52	2	412	510	48.5	2 800	3 600	23120RZ	23120RZK	110	114	155	147	2	0.29	2.33	3.47	2.28	4.52	4.38
	180	46	2.1	470	481	47.6	2 600	3 400	22220RZ	22220RZK	112	115	168	163	2	0.25	2.74	4.08	2.68	5.11	5.00
	180	60.3	2.1	533	629	53.5	2 600	3 400	23220RZ	23220RZK	112	116	168	157	2	0.32	2.09	3.11	2.04	6.85	6.66
	215	47	3	519	524	40.2	2 200	3 000	21320RZ	21320RZK	114	131	201	184	2.5	0.22	3.02	4.49	2.95	8.79	8.68
	215	73	3	875	877	63.9	2 200	3 000	22320RZ	22320RZK	114	121	201	187	2.5	0.35	1.95	2.90	1.91	13.2	12.9
110	170	45	2	377	486	48.4	2 600	3 400	23022RZ	23022RZK	120	123	160	156	2	0.24	2.84	4.23	2.78	3.85	3.74

[Remark] Standard cage types used for the above bearings are shown in Table 5 earlier in this section.

Spherical roller bearings

d (110) ~ 140 mm

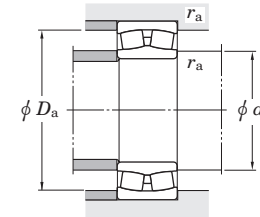
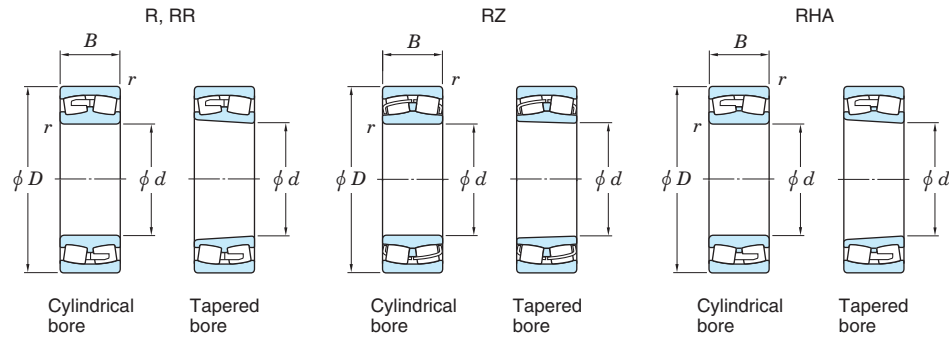

Boundary dimensions (mm)				Basic load ratings (kN)		Fatigue load limit (kN) C_u	Limiting speeds (min ⁻¹)		Bearing No.		Mounting dimensions (mm)					Constant e	Axial load factors			(Refer.) Mass (kg)	
d	D	B	$r_{min.}$	C_r	C_{0r}		Grease lub.	Oil lub.	Cylindrical bore	Tapered bore	d_a min.	d_a max.	D_a max.	D_a min.	r_a max.		Y_1	Y_2	Y_0	Cylindrical bore	Tapered bore
110	170	60	2	472	647	58.6	2 600	3 600	24022RZ	24022RZK30	120	120	160	151	2	0.32	2.08	3.10	2.04	5.07	4.99
	180	56	2	484	605	53.7	2 500	3 300	23122RZ	23122RZK	120	125	170	161	2	0.29	2.36	3.51	2.31	5.72	5.54
	180	69	2	569	778	63.4	2 500	3 300	24122RZ	24122RZK30	120	120	170	154	2	0.37	1.84	2.74	1.80	6.98	6.87
	200	53	2.1	612	642	58.7	2 300	3 000	22222RZ	22222RZK	122	127	188	180	2	0.26	2.64	3.93	2.58	7.37	7.21
	200	69.8	2.1	672	792	65.4	2 300	3 000	23222RZ	23222RZK	122	127	188	173	2	0.34	1.99	2.96	1.94	9.76	9.48
	240	50	3	604	616	46.0	1 900	2 600	21322RZ	21322RZK	124	147	226	205	2.5	0.21	3.19	4.75	3.12	11.8	11.7
	240	80	3	1 040	1 040	77.7	1 900	2 600	22322RZ	22322RZK	124	136	226	208	2.5	0.33	2.03	3.02	1.98	18.1	17.7
120	180	46	2	394	524	51.6	2 300	3 200	23024RZ	23024RZK	130	132	170	165	2	0.23	2.95	4.40	2.89	4.20	4.07
	180	60	2	484	709	61.8	2 300	3 200	24024RZ	24024RZK30	130	130	170	160	2	0.30	2.23	3.32	2.18	5.43	5.34
	200	62	2	571	714	61.2	2 200	3 000	23124RZ	23124RZK	130	137	190	176	2	0.29	2.34	3.49	2.29	7.98	7.74
	200	80	2	733	1 020	78.6	2 200	3 000	24124RZ	24124RZK30	130	133	190	172	2	0.38	1.75	2.61	1.72	10.2	10.0
	215	58	2.1	706	764	67.2	2 100	2 800	22224RZ	22224RZK	132	138	203	193	2	0.26	2.60	3.87	2.54	9.31	9.10
	215	76	2.1	772	956	78.9	2 100	2 900	23224RZ	23224RZK	132	139	203	185	2	0.34	1.97	2.94	1.93	12.2	11.8
	260	86	3	1 120	1 130	87.2	1 800	2 500	22324RZ	22324RZK	134	149	246	228	2.5	0.33	2.03	3.02	1.98	22.8	22.3
130	200	52	2	509	674	63.6	2 200	2 900	23026RZ	23026RZK	140	145	190	182	2	0.24	2.87	4.27	2.80	6.15	5.97
	200	69	2	625	914	77.3	2 200	2 900	24026RZ	24026RZK30	140	143	190	177	2	0.32	2.14	3.18	2.09	8.03	7.90
	210	64	2	621	799	68.4	2 100	2 800	23126RZ	23126RZK	140	147	200	187	2	0.28	2.42	3.61	2.37	8.71	8.44
	210	80	2	754	1 080	91.8	2 100	2 800	24126RZ	24126RZK30	140	145	200	184	2	0.36	1.90	2.83	1.86	10.8	10.6
	230	64	3	821	914	74.4	1 900	2 600	22226RZ	22226RZK	144	148	216	206	2.5	0.26	2.55	3.80	2.50	11.6	11.3
	230	80	3	880	1 090	89.4	1 900	2 600	23226RZ	23226RZK	144	151	216	201	2.5	0.33	2.05	3.05	2.00	14.4	14.0
	280	93	4	1 310	1 340	98.6	1 700	2 200	22326RZ	22326RZK	148	160	262	245	3	0.33	2.03	3.02	1.98	28.5	27.9
140	210	53	2	530	723	67.9	2 100	2 800	23028RZ	23028RZK	150	155	200	192	2	0.23	2.98	4.44	2.92	6.62	6.42
	210	69	2	640	957	81.7	2 100	2 800	24028RZ	24028RZK30	150	153	200	188	2	0.30	2.28	3.39	2.23	8.49	8.35
	225	68	2.1	710	940	79.6	1 900	2 600	23128RZ	23128RZK	152	158	213	201	2	0.28	2.45	3.65	2.40	10.6	10.3
	225	85	2.1	853	1 170	90.7	1 900	2 600	24128RZ	24128RZK30	152	153	213	194	2	0.36	1.89	2.82	1.85	13.1	12.9
	250	68	3	947	1 030	85.2	1 800	2 300	22228RZ	22228RZK	154	158	236	224	2.5	0.26	2.60	3.87	2.54	14.5	14.2
	250	88	3	1 020	1 290	103	1 800	2 300	23228RZ	23228RZK	154	161	236	214	2.5	0.34	1.99	2.96	1.95	19.0	18.4
	300	102	4	1 470	1 570	105	1 500	2 100	22328RZ	22328RZK	158	172	282	255	3	0.35	1.95	2.90	1.90	35.7	34.9

[Remark] Standard cage types used for the above bearings are shown in Table 5 earlier in this section.

Spherical roller bearings

d 150 ~ (170) mm

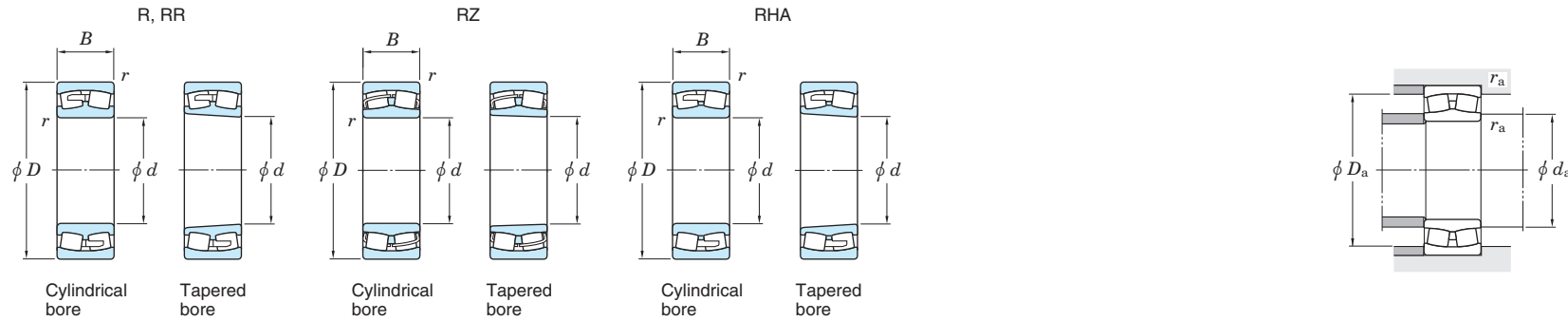

Boundary dimensions (mm)				Basic load ratings (kN)		Fatigue load limit (kN)	Limiting speeds (min ⁻¹)		Bearing No.		Mounting dimensions (mm)					Constant e	Axial load factors			(Refer.) Mass (kg)	
d	D	B	r min.	C _r	C _{0r}	C _u	Grease lub.	Oil lub.	Cylindrical bore	Tapered bore	d _a min.	d _a max.	D _a max.	D _a min.	r _a max.		Y ₁	Y ₂	Y ₀	Cylindrical bore	Tapered bore
150	210	45	2	418	622	62.5	1 600	2 100	23930R	23930RK	160	170	200	195	2	0.20	3.44	5.12	3.36	5.09	4.93
	225	56	2.1	579	797	76.3	1 900	2 500	23030RZ	23030RZK	162	166	213	205	2	0.22	3.04	4.53	2.97	8.01	7.77
	225	75	2.1	724	1 100	90.3	1 900	2 500	24030RZ	24030RZK	162	163	213	199	2	0.30	2.23	3.32	2.18	10.6	10.4
	250	80	2.1	902	1 230	102	1 800	2 300	23130RZ	23130RZK	162	171	238	216	2	0.30	2.24	3.34	2.19	16.4	15.9
	250	100	2.1	1 110	1 590	116	1 800	2 300	24130RZ	24130RZK	162	166	238	213	2	0.38	1.77	2.64	1.73	19.9	19.6
	270	73	3	1 080	1 200	102	1 700	2 200	22230RZ	22230RZK	164	172	256	243	2.5	0.25	2.69	4.00	2.63	18.9	18.5
	270	96	3	1 200	1 540	121	1 700	2 200	23230RZ	23230RZK	164	173	256	230	2.5	0.34	1.96	2.93	1.92	24.5	23.8
	320	108	4	1 540	1 600	175	1 200	1 500	22330R	22330RK	168	195	302	273	3	0.38	1.78	2.64	1.74	43.6	42.7
	320	108	4	1 620	1 740	121	1 200	1 500	22330RHA	22330RHAK	168	196	302	273	3	0.35	1.93	2.87	1.88	40.3	39.4
	160	220	45	2	426	649	65.4	1 500	2 000	23932R	23932RK	170	179	210	204	2	0.19	3.60	5.37	3.52	5.37
240		60	2.1	667	924	86.0	1 800	2 300	23032RZ	23032RZK	172	177	228	219	2	0.22	3.01	4.48	2.94	9.74	9.44
240		80	2.1	829	1 270	103	1 800	2 300	24032RZ	24032RZK30	172	175	228	215	2	0.30	2.24	3.34	2.19	12.9	12.7
270		86	2.1	1 070	1 430	117	1 700	2 200	23132RZ	23132RZK	172	182	258	234	2	0.30	2.22	3.30	2.17	20.8	20.2
270		109	2.1	1 270	1 720	145	1 300	1 700	24132RR	24132RRK30	172	188	258	230	2	0.39	1.72	2.56	1.68	25.9	25.5
290		80	3	1 110	1 270	127	1 200	1 600	22232R	22232RK	174	199	276	257	2.5	0.28	2.40	3.57	2.35	23.4	22.9
290		80	3	1 120	1 320	97.1	1 200	1 600	22232RHA	22232RHAK	174	200	276	257	2.5	0.27	2.49	3.71	2.44	21.9	21.4
290		104	3	1 290	1 650	163	1 200	1 600	23232R	23232RK	174	194	276	245	2.5	0.38	1.79	2.66	1.75	31.0	30.1
290		104	3	1 370	1 780	139	1 200	1 600	23232RHA	23232RHAK	174	193	276	245	2.5	0.36	1.87	2.78	1.83	29.4	28.5
340		114	4	1 720	1 790	188	1 100	1 400	22332R	22332RK	178	207	322	290	3	0.38	1.76	2.62	1.72	51.9	51.0
340		114	4	1 780	1 940	135	1 100	1 400	22332RHA	22332RHAK	178	210	322	290	3	0.35	1.94	2.89	1.90	48.0	47.1
170		230	45	2	441	691	69.6	1 400	1 900	23934R	23934RK	180	189	220	214	2	0.18	3.78	5.63	3.70	5.67
	260	67	2.1	795	1 090	97.9	1 700	2 200	23034RZ	23034RZK	182	189	248	236	2	0.23	2.90	4.31	2.83	13.2	12.8
	260	90	2.1	1 010	1 540	120	1 700	2 200	24034RZ	24034RZK30	182	184	248	227	2	0.32	2.11	3.15	2.07	17.5	17.2
	280	88	2.1	1 150	1 550	124	1 500	2 100	23134RZ	23134RZK	182	194	268	249	2	0.29	2.30	3.43	2.25	21.9	21.2
	280	109	2.1	1 320	1 820	154	1 200	1 600	24134RR	24134RRK30	182	198	268	241	2	0.37	1.80	2.68	1.76	27.2	26.8
	310	86	4	1 190	1 390	141	1 100	1 500	22234R	22234RK	188	212	292	271	3	0.29	2.29	3.41	2.24	29.0	28.4
	310	86	4	1 260	1 490	109	1 100	1 500	22234RHA	22234RHAK	188	210	292	271	3	0.28	2.45	3.64	2.39	27.1	26.5
	310	110	4	1 560	1 920	127	1 100	1 500	23234RR	23234RRK	188	209	292	268	3	0.37	1.85	2.75	1.80	37.2	36.1
	310	110	4	1 520	1 940	147	1 100	1 500	23234RHA	23234RHAK	188	207	292	261	3	0.36	1.89	2.82	1.85	35.6	34.6

[Remark] Standard cage types used for the above bearings are shown in Table 5 earlier in this section.

Spherical roller bearings

d (170) ~ (190) mm

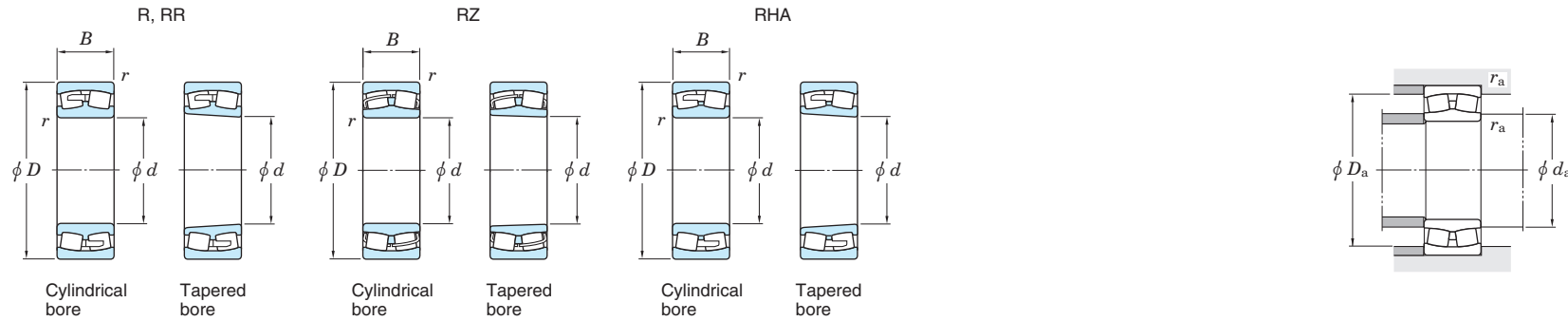

Boundary dimensions (mm)				Basic load ratings (kN)		Fatigue load limit (kN)	Limiting speeds (min ⁻¹)		Bearing No.		Mounting dimensions (mm)					Constant	Axial load factors			(Refer.) Mass (kg)		
d	D	B	r min.	C _r	C _{0r}	C _u	Grease lub.	Oil lub.	Cylindrical bore	Tapered bore	d _a min.	d _a max.	D _a max.	D _a min.	r _a max.	e	Y ₁	Y ₂	Y ₀	Cylindrical bore	Tapered bore	
170	360	120	4	1 830	1 920	206	1 000	1 300	22334R	22334RK	188	221	342	307	3	0.38	1.77	2.64	1.73	62.0	60.8	
	360	120	4	1 990	2 200	150	1 000	1 300	22334RHA	22334RHAK	188	222	342	307	3	0.35	1.95	2.91	1.91	57.3	56.1	
180	250	52	2	599	939	88.9	1 300	1 700	23936R	23936RK	190	203	240	232	2	0.19	3.55	5.29	3.48	8.22	7.97	
	280	74	2.1	966	1 330	118	1 500	1 900	23036RZ	23036RZK	192	202	268	253	2	0.24	2.84	4.23	2.78	17.4	16.9	
	280	100	2.1	1 170	1 710	138	1 200	1 600	24036RR	24036RRK30	192	206	268	246	2	0.34	2.00	2.98	1.96	23.4	23.0	
	300	96	3	1 260	1 800	165	1 100	1 500	23136R	23136RK	194	214	286	259	2.5	0.33	2.04	3.04	2.00	28.4	27.5	
	300	96	3	1 330	1 790	139	1 100	1 500	23136RHA	23136RHAK	194	215	286	265	2.5	0.31	2.19	3.25	2.14	26.5	25.6	
	300	118	3	1 530	2 120	176	1 100	1 500	24136RR	24136RRK30	194	211	286	258	2.5	0.38	1.78	2.65	1.74	34.4	33.9	
	300	118	3	1 510	2 240	155	1 100	1 500	24136RHA	24136RHAK30	194	207	286	255	2.5	0.38	1.79	2.66	1.75	31.8	31.2	
	320	86	4	1 220	1 450	165	1 100	1 400	22236R	22236RK	198	222	302	281	3	0.28	2.37	3.53	2.32	30.5	29.8	
	320	86	4	1 320	1 610	118	1 100	1 400	22236RHA	22236RHAK	198	221	302	281	3	0.26	2.55	3.80	2.50	28.5	27.8	
	320	112	4	1 640	2 100	134	1 100	1 400	23236RR	23236RRK	198	219	302	279	3	0.36	1.87	2.78	1.83	39.8	38.6	
	320	112	4	1 660	2 170	166	1 100	1 400	23236RHA	23236RHAK	198	220	302	277	3	0.34	1.97	2.93	1.92	37.7	36.5	
	380	126	4	2 180	2 360	263	920	1 200	22336R	22336RK	198	237	362	327	3	0.36	1.89	2.81	1.84	71.4	69.9	
	380	126	4	2 180	2 410	163	930	1 200	22336RHA	22336RHAK	198	235	362	323	3	0.34	1.97	2.94	1.93	66.0	64.5	
	190	260	52	2	608	969	90.7	1 200	1 600	23938R	23938RK	200	212	250	241	2	0.18	3.69	5.50	3.61	8.40	8.10
		290	75	2.1	923	1 370	132	1 100	1 500	23038R	23038RK	202	221	278	260	2	0.25	2.67	3.97	2.61	18.8	18.2
		290	75	2.1	992	1 430	115	1 100	1 500	23038RHA	23038RHAK	202	219	278	260	2	0.25	2.75	4.10	2.69	17.2	16.6
290		100	2.1	1 240	1 840	161	1 100	1 500	24038RR	24038RRK30	202	215	278	257	2	0.33	2.06	3.07	2.02	24.5	24.1	
290		100	2.1	1 230	1 920	152	1 100	1 500	24038RHA	24038RHAK30	202	215	278	256	2	0.32	2.14	3.19	2.09	22.4	22.0	
320		104	3	1 370	2 000	162	1 000	1 400	23138R	23138RK	204	229	306	275	2.5	0.34	1.96	2.92	1.92	35.5	34.4	
320		104	3	1 520	2 080	161	1 000	1 400	23138RHA	23138RHAK	204	227	306	281	2.5	0.31	2.14	3.19	2.10	33.2	32.1	
320		128	3	1 750	2 470	198	1 000	1 400	24138RR	24138RRK30	204	223	306	272	2.5	0.39	1.74	2.59	1.70	43.0	42.4	
320		128	3	1 770	2 630	179	1 000	1 400	24138RHA	24138RHAK30	204	222	306	272	2.5	0.38	1.76	2.63	1.72	40.1	39.5	
340		92	4	1 390	1 730	172	1 000	1 300	22238R	22238RK	208	236	322	296	3	0.29	2.29	3.41	2.24	37.4	36.6	
340		92	4	1 420	1 770	128	1 000	1 300	22238RHA	22238RHAK	208	234	322	296	3	0.27	2.52	3.76	2.46	34.9	34.1	
340		120	4	1 830	2 370	160	1 000	1 300	23238RR	23238RRK	208	233	322	294	3	0.36	1.86	2.76	1.81	48.5	47.1	
340		120	4	1 870	2 470	185	990	1 300	23238RHA	23238RHAK	208	233	322	293	3	0.35	1.94	2.89	1.90	44.9	43.5	
400		132	5	2 380	2 610	258	880	1 200	22338R	22338RK	212	248	378	342	4	0.38	1.79	2.66	1.75	84.1	82.4	

[Remark] Standard cage types used for the above bearings are shown in Table 5 earlier in this section.

Spherical roller bearings

d (190) ~ (220) mm

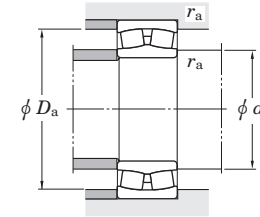
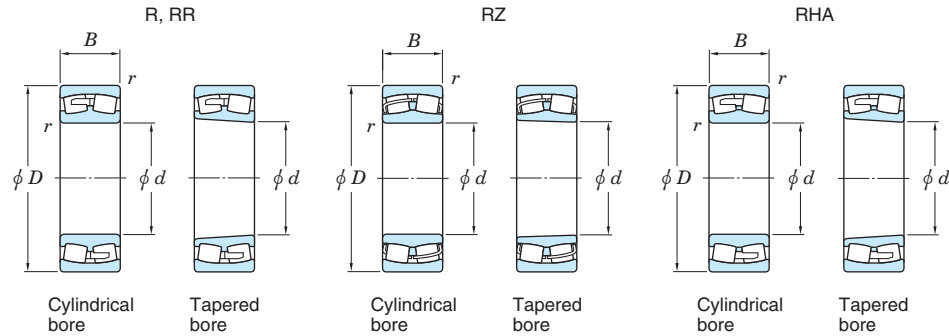

Boundary dimensions (mm)				Basic load ratings (kN)		Fatigue load limit (kN) <i>C_u</i>	Limiting speeds (min ⁻¹)		Bearing No.		Mounting dimensions (mm)					Constant <i>e</i>	Axial load factors			(Refer.) Mass (kg)	
<i>d</i>	<i>D</i>	<i>B</i>	<i>r</i> _{min.}	<i>C_r</i>	<i>C_{0r}</i>		Grease lub.	Oil lub.	Cylindrical bore	Tapered bore	<i>d_a</i> _{min.}	<i>d_a</i> _{max.}	<i>D_a</i> _{max.}	<i>d_a</i> _{min.}	<i>r_a</i> _{max.}		<i>Y</i> ₁	<i>Y</i> ₂	<i>Y</i> ₀	Cylindrical bore	Tapered bore
190	400	132	5	2 430	2 810	192	870	1 200	22338RHA	22338RHAK	212	251	378	342	4	0.34	1.99	2.97	1.95	77.7	76.0
200	280	60	2.1	753	1 190	109	1 100	1 500	23940R	23940RK	212	226	268	259	2	0.20	3.44	5.13	3.37	12.0	11.6
	310	82	2.1	1 120	1 670	155	1 000	1 400	23040R	23040RK	212	235	298	278	2	0.26	2.62	3.90	2.56	24.1	23.4
	310	82	2.1	1 180	1 680	133	1 100	1 400	23040RHA	23040RHAK	212	231	298	278	2	0.25	2.68	3.99	2.62	22.0	21.3
	310	109	2.1	1 430	2 110	180	1 100	1 400	24040RR	24040RRK30	212	228	298	273	2	0.33	2.02	3.00	1.97	31.2	30.7
	310	109	2.1	1 440	2 230	173	1 100	1 400	24040RHA	24040RHAK30	212	227	298	272	2	0.33	2.06	3.07	2.02	28.5	28.0
	340	112	3	1 740	2 350	186	980	1 300	23140RR	23140RRK	214	241	326	298	2.5	0.33	2.04	3.03	1.99	43.3	42.0
	340	112	3	1 730	2 340	178	970	1 300	23140RHA	23140RHAK	214	239	326	297	2.5	0.32	2.10	3.13	2.06	40.8	39.5
	340	140	3	2 030	2 820	222	990	1 300	24140RR	24140RRK30	214	234	326	289	2.5	0.40	1.68	2.49	1.64	53.3	52.5
	340	140	3	2 000	2 970	196	990	1 300	24140RHA	24140RHAK30	214	232	326	286	2.5	0.41	1.65	2.46	1.62	49.5	48.7
	360	98	4	1 620	2 050	138	930	1 200	22240RR	22240RRK	218	252	342	316	3	0.30	2.26	3.36	2.21	45.0	44.0
	360	98	4	1 630	2 030	146	940	1 300	22240RHA	22240RHAK	218	247	342	316	3	0.27	2.50	3.72	2.45	42.0	41.0
	360	128	4	1 950	2 610	228	940	1 300	23240R	23240RK	218	244	342	306	3	0.38	1.79	2.67	1.75	58.1	56.4
	360	128	4	2 080	2 780	209	930	1 200	23240RHA	23240RHAK	218	245	342	309	3	0.35	1.92	2.86	1.88	55.1	53.4
	420	138	5	2 510	2 750	288	830	1 100	22340R	22340RK	222	260	398	359	4	0.38	1.80	2.68	1.76	95.4	93.5
	420	138	5	2 570	2 920	193	820	1 100	22340RHA	22340RHAK	222	262	398	356	4	0.34	1.99	2.97	1.95	88.1	86.2
220	300	60	2.1	792	1 300	119	1 000	1 400	23944R	23944RK	232	246	288	279	2	0.18	3.70	5.50	3.61	13.0	12.6
	340	90	3	1 230	1 890	173	940	1 300	23044R	23044RK	234	256	326	301	2.5	0.26	2.55	3.80	2.50	31.5	30.6
	340	90	3	1 370	1 950	148	940	1 200	23044RHA	23044RHAK	234	255	326	307	2.5	0.25	2.69	4.01	2.63	28.8	27.9
	340	118	3	1 660	2 480	208	950	1 300	24044RR	24044RRK30	234	251	326	300	2.5	0.33	2.04	3.04	2.00	40.5	39.8
	340	118	3	1 680	2 630	199	950	1 300	24044RHA	24044RHAK30	234	248	326	297	2.5	0.33	2.08	3.09	2.03	37.0	36.4
	370	120	4	1 810	2 700	205	880	1 200	23144R	23144RK	238	266	352	319	3	0.34	2.00	2.98	1.96	54.8	53.2
	370	120	4	2 000	2 790	208	870	1 200	23144RHA	23144RHAK	238	263	352	324	3	0.31	2.15	3.20	2.10	51.2	49.6
	370	150	4	2 360	3 390	258	880	1 200	24144RR	24144RRK30	238	258	352	315	3	0.39	1.71	2.55	1.67	67.3	66.2
	370	150	4	2 330	3 550	229	880	1 200	24144RHA	24144RHAK30	238	255	352	313	3	0.40	1.69	2.52	1.65	62.0	61.0
	400	108	4	2 000	2 410	257	820	1 100	22244RR	22244RRK	238	276	382	355	3	0.28	2.40	3.57	2.34	60.3	59.0
	400	108	4	1 980	2 440	168	820	1 100	22244RHA	22244RHAK	238	274	382	349	3	0.27	2.52	3.76	2.47	58.8	57.5
	400	144	4	2 350	3 200	259	830	1 100	23244R	23244RK	238	268	382	336	3	0.39	1.71	2.55	1.68	81.6	79.2
	400	144	4	2 520	3 350	239	810	1 100	23244RHA	23244RHAK	238	272	382	346	3	0.36	1.89	2.81	1.85	77.4	75.0

[Remark] Standard cage types used for the above bearings are shown in Table 5 earlier in this section.

Spherical roller bearings

d (220) ~ (260) mm

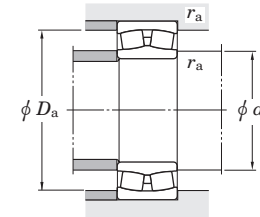
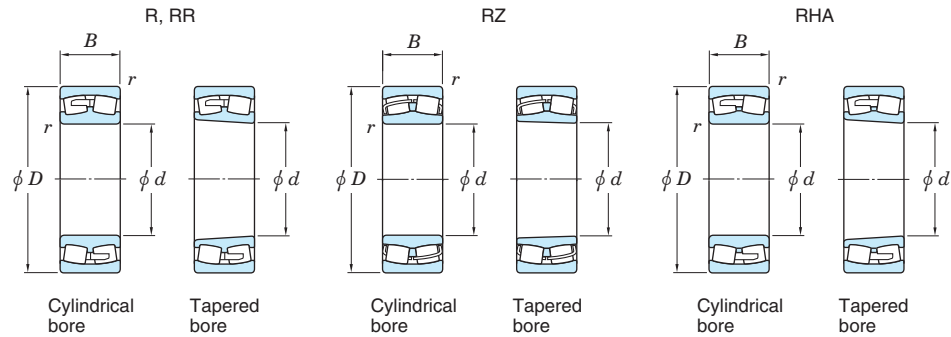

Boundary dimensions (mm)				Basic load ratings (kN)		Fatigue load limit (kN)	Limiting speeds (min ⁻¹)		Bearing No.		Mounting dimensions (mm)					Constant	Axial load factors			(Refer.) Mass (kg)	
d	D	B	r _{min.}	C _r	C _{0r}	C _u	Grease lub.	Oil lub.	Cylindrical bore	Tapered bore	d _a min.	d _a max.	D _a max.	D _a min.	r _a max.	e	Y ₁	Y ₂	Y ₀	Cylindrical bore	Tapered bore
220	460	145	5	2 980	3 380	359	720	960	22344R	22344RK	242	290	438	393	4	0.34	2.00	2.99	1.96	124	122
	460	145	5	2 960	3 470	226	730	970	22344RHA	22344RHAK	242	290	438	390	4	0.32	2.08	3.09	2.03	115	113
240	320	60	2.1	814	1 380	128	940	1 300	23948R	23948RK	252	265	308	298	2	0.17	3.95	5.88	3.86	14.0	13.5
	360	92	3	1 480	2 190	161	860	1 100	23048RR	23048RRK	254	276	346	327	2.5	0.25	2.73	4.07	2.67	33.9	32.9
	360	92	3	1 470	2 180	166	860	1 100	23048RHA	23048RHAK	254	275	346	327	2.5	0.24	2.83	4.21	2.77	31.9	30.9
	360	118	3	1 750	2 710	228	870	1 200	24048RR	24048RRK30	254	272	346	321	2.5	0.31	2.20	3.27	2.15	43.5	42.9
	360	118	3	1 750	2 840	215	870	1 200	24048RHA	24048RHAK30	254	269	346	321	2.5	0.30	2.24	3.33	2.19	39.6	39.0
	400	128	4	2 280	3 220	213	790	1 100	23148RR	23148RRK	258	287	382	353	3	0.32	2.11	3.14	2.06	67.2	65.1
	400	128	4	2 270	3 200	233	790	1 000	23148RHA	23148RHAK	258	286	382	353	3	0.31	2.19	3.25	2.14	63.1	61.1
	400	160	4	2 640	3 850	287	800	1 100	24148RR	24148RRK30	258	280	382	340	3	0.39	1.75	2.60	1.71	82.7	81.4
	400	160	4	2 670	4 130	262	800	1 100	24148RHA	24148RHAK30	258	278	382	340	3	0.39	1.72	2.56	1.68	76.6	75.3
	440	120	4	2 390	2 940	295	730	970	22248R	22248RK	258	299	422	384	3	0.29	2.35	3.50	2.30	85.0	83.2
	440	120	4	2 400	2 990	202	730	970	22248RHA	22248RHAK	258	299	422	384	3	0.27	2.49	3.71	2.43	79.4	77.6
	440	160	4	3 050	3 970	310	730	970	23248RR	23248RRK	258	295	422	376	3	0.38	1.78	2.64	1.74	110	107
	440	160	4	3 080	4 130	289	730	970	23248RHA	23248RHAK	258	295	422	376	3	0.36	1.87	2.78	1.83	104	101
	500	155	5	3 360	4 020	347	650	870	22348R	22348RK	262	320	478	420	4	0.35	1.94	2.89	1.90	157	154
	500	155	5	3 400	3 990	255	650	870	22348RHA	22348RHAK	262	315	478	426	4	0.32	2.12	3.16	2.07	145	142
260	360	75	2.1	1 140	1 880	160	820	1 100	23952R	23952RK	272	292	348	333	2	0.19	3.54	5.27	3.46	24.0	23.3
	400	104	4	1 670	2 570	212	760	1 000	23052R	23052RK	278	304	382	359	3	0.25	2.65	3.95	2.59	50.7	49.3
	400	104	4	1 850	2 720	201	760	1 000	23052RHA	23052RHAK	278	302	382	359	3	0.25	2.75	4.10	2.69	46.3	44.9
	400	140	4	2 280	3 570	282	770	1 000	24052RR	24052RRK30	278	296	382	352	3	0.33	2.02	3.01	1.98	66.3	65.2
	400	140	4	2 270	3 670	265	770	1 000	24052RHA	24052RHAK30	278	292	382	347	3	0.33	2.06	3.07	2.02	60.3	59.4
	440	144	4	2 760	3 850	231	710	940	23152RR	23152RRK	278	313	422	387	3	0.33	2.05	3.06	2.01	92.2	89.4
	440	144	4	2 790	4 000	285	700	930	23152RHA	23152RHAK	278	311	422	384	3	0.32	2.12	3.16	2.08	87.4	84.6
	440	180	4	3 250	4 700	345	720	950	24152RR	24152RRK30	278	304	422	374	3	0.40	1.69	2.51	1.65	114	112
	440	180	4	3 210	4 950	309	720	950	24152RHA	24152RHAK30	278	299	422	368	3	0.41	1.66	2.47	1.62	106	105
	480	130	5	2 800	3 460	347	650	870	22252R	22252RK	282	326	458	419	4	0.28	2.40	3.57	2.35	110	108
	480	130	5	2 790	3 430	226	650	870	22252RHA	22252RHAK	282	324	458	418	4	0.27	2.50	3.72	2.44	103	101
	480	174	5	3 440	4 640	326	640	860	23252R	23252RK	282	325	458	408	4	0.40	1.69	2.51	1.65	144	140

[Remark] Standard cage types used for the above bearings are shown in Table 5 earlier in this section.

Spherical roller bearings

d (260) ~ (300) mm

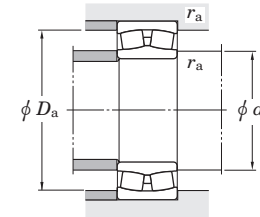
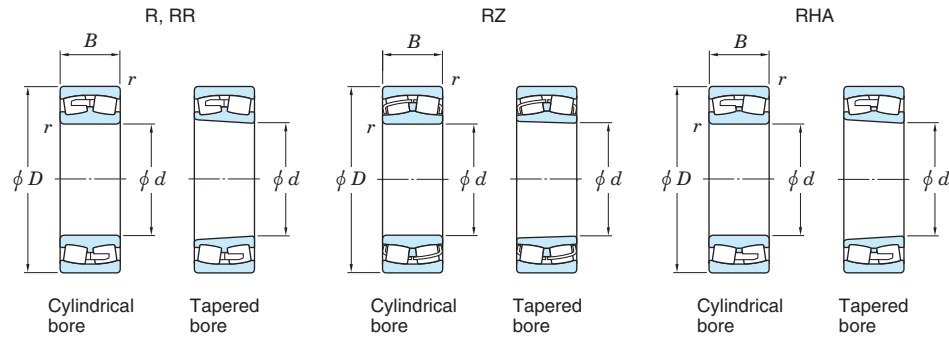

Boundary dimensions (mm)				Basic load ratings (kN)		Fatigue load limit (kN) C_u	Limiting speeds (min ⁻¹)		Bearing No.		Mounting dimensions (mm)					Constant e	Axial load factors			(Refer.) Mass (kg)	
d	D	B	$r_{min.}$	C_r	C_{Or}		Grease lub.	Oil lub.	Cylindrical bore	Tapered bore	d_a min.	d_a max.	D_a max.	D_a min.	r_a max.		Y_1	Y_2	Y_0	Cylindrical bore	Tapered bore
260	480	174	5	3 590	4 900	280	650	860	23252RHA	23252RHAK	282	322	458	408	4	0.36	1.87	2.78	1.83	137	133
	540	165	6	3 540	4 380	363	590	780	22352R	22352RK	288	346	512	453	5	0.35	1.94	2.89	1.90	196	192
	540	165	6	3 900	4 620	290	580	780	22352RHA	22352RHAK	288	342	512	461	5	0.31	2.15	3.21	2.11	181	177
280	380	75	2.1	1 160	1 960	165	760	1 000	23956R	23956RK	292	312	368	353	2	0.18	3.74	5.57	3.66	26.0	25.2
	420	106	4	1 790	2 860	235	710	950	23056R	23056RK	298	322	402	377	3	0.25	2.74	4.08	2.68	54.5	52.9
	420	106	4	1 940	2 950	218	700	940	23056RHA	23056RHAK	298	322	402	380	3	0.24	2.87	4.27	2.80	49.8	48.2
	420	140	4	2 370	3 780	291	710	950	24056RR	24056RRK30	298	316	402	373	3	0.31	2.15	3.21	2.11	70.2	69.1
	420	140	4	2 390	4 000	287	710	950	24056RHA	24056RHAK30	298	314	402	372	3	0.31	2.20	3.28	2.15	64.0	62.9
	460	146	5	2 910	4 160	250	660	880	23156RR	23156RRK	302	332	438	407	4	0.32	2.14	3.18	2.09	98.8	95.7
	460	146	5	2 940	4 290	304	650	870	23156RHA	23156RHAK	302	331	438	406	4	0.30	2.22	3.30	2.17	93.4	90.3
	460	180	5	3 390	5 140	370	660	880	24156RR	24156RRK30	302	326	438	396	4	0.38	1.79	2.67	1.75	122	120
	460	180	5	3 320	5 240	322	660	880	24156RHA	24156RHAK30	302	321	438	390	4	0.38	1.76	2.62	1.72	113	112
	500	130	5	2 640	3 380	308	610	810	22256R	22256RK	302	347	478	438	4	0.28	2.42	3.60	2.37	114	112
	500	130	5	2 900	3 670	240	610	810	22256RHA	22256RHAK	302	346	478	440	4	0.26	2.64	3.93	2.58	106	104
	500	176	5	3 370	4 910	323	610	820	23256R	23256RK	302	345	478	421	4	0.37	1.83	2.72	1.79	153	149
	500	176	5	3 770	5 300	365	600	800	23256RHA	23256RHAK	302	343	478	430	4	0.35	1.95	2.91	1.91	145	141
	580	175	6	3 930	4 910	407	530	710	22356R	22356RK	308	372	552	486	5	0.34	1.98	2.95	1.93	229	225
	580	175	6	4 390	5 260	325	530	700	22356RHA	22356RHAK	308	367	552	495	5	0.31	2.19	3.25	2.14	212	208
300	420	90	3	1 610	2 610	220	680	910	23960R	23960RK	314	336	406	387	2.5	0.20	3.42	5.09	3.34	40.0	38.8
	460	118	4	2 190	3 480	286	630	840	23060R	23060RK	318	351	442	412	3	0.25	2.69	4.00	2.63	75.8	73.7
	460	118	4	2 370	3 700	255	630	840	23060RHA	23060RHAK	318	347	442	416	3	0.24	2.79	4.16	2.73	68.9	66.8
	460	160	4	2 950	4 690	354	640	850	24060RR	24060RRK30	318	342	442	406	3	0.33	2.04	3.04	2.00	99.5	97.9
	460	160	4	2 950	4 910	350	640	850	24060RHA	24060RHAK30	318	338	442	404	3	0.32	2.09	3.11	2.04	90.7	89.1
	500	160	5	3 450	5 030	351	590	790	23160RR	23160RRK	322	358	478	439	4	0.32	2.09	3.11	2.04	131	127
	500	160	5	3 430	4 970	345	580	780	23160RHA	23160RHAK	322	357	478	439	4	0.31	2.18	3.25	2.13	123	119
	500	200	5	4 160	6 280	433	590	790	24160RR	24160RRK30	322	349	478	425	4	0.40	1.67	2.49	1.63	162	160
	500	200	5	4 030	6 420	385	590	790	24160RHA	24160RHAK30	322	347	478	424	4	0.39	1.72	2.56	1.68	150	148
	540	140	5	3 360	4 330	412	550	740	22260R	22260RK	322	368	518	467	4	0.27	2.48	3.69	2.43	145	142
	540	140	5	3 320	4 360	284	550	740	22260RHA	22260RHAK	322	370	518	467	4	0.26	2.62	3.90	2.56	135	132

[Remark] Standard cage types used for the above bearings are shown in Table 5 earlier in this section.

Spherical roller bearings

d (300) ~ (360) mm

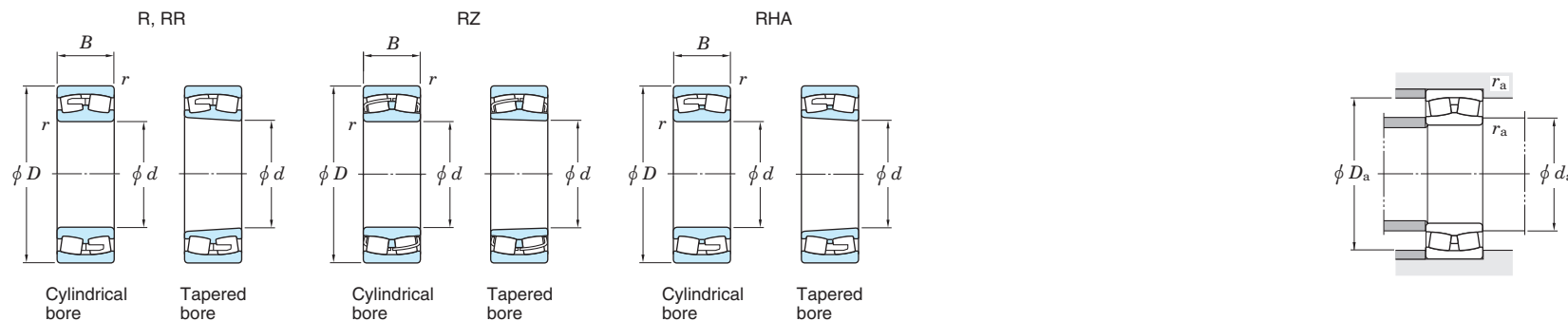

Boundary dimensions (mm)				Basic load ratings (kN)		Fatigue load limit (kN) C _u	Limiting speeds (min ⁻¹)		Bearing No.		Mounting dimensions (mm)					Constant e	Axial load factors			(Refer.) Mass (kg)	
d	D	B	r _{min.}	C _r	C _{0r}		Grease lub.	Oil lub.	Cylindrical bore	Tapered bore	d _a min.	d _a max.	D _a max.	D _a min.	r _a max.		Y ₁	Y ₂	Y ₀	Cylindrical bore	Tapered bore
300	540	192	5	4 300	5 910	401	540	720	23260R	23260RK	322	370	518	464	4	0.37	1.83	2.72	1.79	197	192
	540	192	5	4 440	6 310	429	540	720	23260RHA	23260RHAK	322	371	518	464	4	0.35	1.93	2.88	1.89	187	182
	620	185	7.5	4 890	5 430	555	470	630	22360R	22360RK	336	390	584	547	6	0.32	2.09	3.10	2.04	289	284
320	440	90	3	1 670	2 870	233	630	840	23964R	23964RK	334	358	426	408	2.5	0.19	3.61	5.38	3.53	43.0	41.7
	480	121	4	2 290	3 740	295	590	790	23064R	23064RK	338	369	462	431	3	0.24	2.76	4.11	2.70	81.2	78.8
	480	121	4	2 490	3 850	278	590	780	23064RHA	23064RHAK	338	367	462	436	3	0.24	2.87	4.27	2.80	74.5	72.1
	480	160	4	3 020	4 920	382	590	790	24064RR	24064RRK30	338	363	462	427	3	0.31	2.16	3.22	2.11	105	103
	480	160	4	3 060	5 230	363	590	790	24064RHA	24064RHAK30	338	360	462	425	3	0.31	2.21	3.29	2.16	93.4	91.4
	540	176	5	3 650	5 700	366	530	700	23164R	23164RK	342	389	518	467	4	0.33	2.04	3.04	2.00	171	166
	540	176	5	4 040	5 960	404	530	700	23164RHA	23164RHAK	342	383	518	472	4	0.32	2.13	3.17	2.08	160	155
	540	218	5	4 680	6 950	486	530	710	24164RR	24164RRK30	342	373	518	460	4	0.39	1.72	2.56	1.68	208	205
	540	218	5	4 550	7 190	429	530	710	24164RHA	24164RHAK30	342	371	518	458	4	0.40	1.70	2.52	1.66	199	196
	580	150	5	3 420	4 540	385	490	660	22264R	22264RK	342	402	558	504	4	0.28	2.41	3.59	2.35	175	171
	580	208	5	4 550	6 550	496	500	670	23264R	23264RK	342	394	558	488	4	0.38	1.76	2.62	1.72	249	242
580	208	5	5 020	7 030	464	490	650	23264RHA	23264RHAK	342	392	558	495	4	0.36	1.90	2.83	1.86	236	229	
340	460	90	3	1 680	2 980	242	590	790	23968R	23968RK	354	377	446	426	2.5	0.18	3.82	5.69	3.74	45.0	43.6
	520	133	5	2 670	4 330	353	530	710	23068R	23068RK	362	397	498	465	4	0.25	2.69	4.00	2.63	108	105
	520	133	5	2 930	4 470	312	530	710	23068RHA	23068RHAK	362	393	498	468	4	0.24	2.80	4.18	2.74	98.7	95.7
	520	180	5	3 680	5 970	432	530	710	24068RR	24068RRK30	362	387	498	460	4	0.33	2.06	3.06	2.01	142	140
	520	180	5	3 720	6 330	430	530	710	24068RHA	24068RHAK30	362	385	498	459	4	0.32	2.11	3.14	2.06	130	128
	580	190	5	4 130	6 430	472	480	640	23168R	23168RK	362	413	558	497	4	0.34	1.97	2.93	1.93	216	210
	580	190	5	4 620	6 720	449	480	640	23168RHA	23168RHAK	362	407	558	503	4	0.32	2.11	3.14	2.06	202	196
	580	243	5	5 570	8 400	564	490	650	24168RR	24168RRK30	362	396	558	490	4	0.41	1.64	2.45	1.61	270	266
	580	243	5	5 490	8 810	449	490	650	24168RHA	24168RHAK30	362	390	558	482	4	0.42	1.61	2.39	1.57	259	255
	620	165	6	4 430	5 430	551	440	590	22268R	22268RK	368	424	592	551	5	0.28	2.43	3.61	2.37	221	216
	620	224	6	5 130	7 560	526	450	600	23268R	23268RK	368	423	592	521	5	0.38	1.77	2.63	1.73	306	297
	620	224	6	5 690	8 030	517	440	590	23268RHA	23268RHAK	368	418	592	532	5	0.36	1.88	2.81	1.84	290	281
	360	480	90	3	1 710	3 060	248	550	730	23972R	23972RK	374	399	466	447	2.5	0.17	3.95	5.88	3.86	46.5

[Remark] Standard cage types used for the above bearings are shown in Table 5 earlier in this section.

Spherical roller bearings

d (360) ~ (400) mm

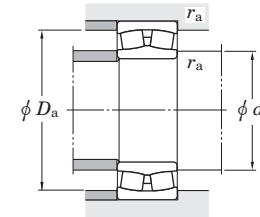
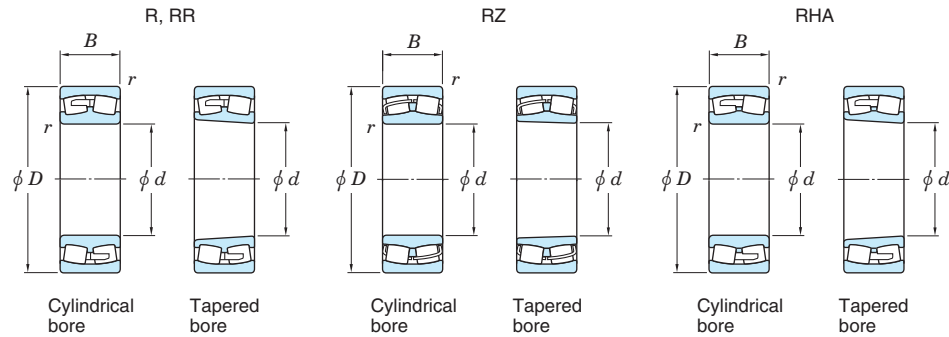

Boundary dimensions (mm)				Basic load ratings (kN)		Fatigue load limit (kN) C _u	Limiting speeds (min ⁻¹)		Bearing No.		Mounting dimensions (mm)					Constant e	Axial load factors			(Refer.) Mass (kg)	
d	D	B	r _{min.}	C _r	C _{0r}		Grease lub.	Oil lub.	Cylindrical bore	Tapered bore	d _a min.	d _a max.	D _a max.	D _a min.	r _a max.		Y ₁	Y ₂	Y ₀	Cylindrical bore	Tapered bore
360	540	134	5	2 860	4 800	375	500	660	23072R	23072RK	382	416	518	484	4	0.24	2.76	4.11	2.70	115	111
	540	134	5	3 040	4 770	334	500	660	23072RHA	23072RHAK	382	414	518	489	4	0.23	2.92	4.34	2.85	105	101
	540	180	5	3 810	6 300	465	500	660	24072RR	24072RRK30	382	407	518	481	4	0.31	2.15	3.21	2.11	149	147
	540	180	5	3 810	6 620	446	500	660	24072RHA	24072RHAK30	382	406	518	480	4	0.30	2.22	3.30	2.17	135	133
	600	192	5	4 740	7 040	459	440	590	23172R	23172RK	382	431	578	527	4	0.33	2.07	3.09	2.03	228	221
	600	192	5	4 830	7 210	474	450	590	23172RHA	23172RHAK	382	429	578	527	4	0.31	2.19	3.25	2.14	213	206
	600	243	5	5 080	7 690	437	450	600	24172R	24172RK30	382	420	578	512	4	0.39	1.74	2.59	1.70	287	283
	600	243	5	5 580	9 180	517	460	610	24172RHA	24172RHAK30	382	413	578	505	4	0.40	1.69	2.51	1.65	274	270
	650	170	6	4 710	5 830	583	410	550	22272R	22272RK	388	447	622	579	5	0.27	2.47	3.68	2.42	248	243
	650	232	6	6 080	8 810	548	410	540	23272R	23272RK	388	446	622	555	5	0.37	1.83	2.72	1.79	346	336
650	232	6	6 220	9 050	591	410	550	23272RHA	23272RHAK	388	442	622	558	5	0.35	1.92	2.85	1.87	328	318	
380	520	106	4	2 220	3 940	295	500	660	23976R	23976RK	398	425	502	481	3	0.19	3.62	5.39	3.54	70.0	67.9
	560	135	5	2 910	4 970	355	470	630	23076R	23076RK	402	433	538	503	4	0.24	2.79	4.16	2.73	122	118
	560	135	5	3 160	5 080	354	460	620	23076RHA	23076RHAK	402	434	538	512	4	0.22	3.03	4.51	2.96	112	108
	560	180	5	3 900	6 590	486	470	620	24076RR	24076RRK30	402	428	538	502	4	0.30	2.26	3.36	2.21	156	154
	560	180	5	3 900	6 910	454	470	620	24076RHA	24076RHAK30	402	426	538	502	4	0.29	2.32	3.45	2.27	142	139
	620	194	5	4 520	7 320	442	420	560	23176R	23176RK	402	454	598	540	4	0.31	2.18	3.24	2.13	240	233
	620	194	5	5 030	7 700	503	420	560	23176RHA	23176RHAK	402	450	598	547	4	0.30	2.26	3.36	2.21	224	217
	620	243	5	5 300	8 220	467	430	570	24176R	24176RK30	402	439	598	529	4	0.38	1.78	2.65	1.74	302	297
	620	243	5	5 870	9 840	561	420	560	24176RHA	24176RHAK30	402	438	598	534	4	0.38	1.78	2.65	1.74	288	283
	680	240	6	6 510	9 500	590	380	500	23276R	23276RK	408	469	652	583	5	0.36	1.85	2.76	1.81	386	375
	680	240	6	6 660	9 760	622	380	510	23276RHA	23276RHAK	408	466	652	586	5	0.35	1.94	2.89	1.90	365	354
	400	540	106	4	2 350	4 300	320	470	620	23980R	23980RK	418	443	522	500	3	0.18	3.76	5.59	3.67	73.0
600		148	5	3 390	5 790	408	420	560	23080R	23080RK	422	462	578	540	4	0.24	2.84	4.23	2.78	155	151
600		148	5	3 690	5 860	398	420	560	23080RHA	23080RHAK	422	460	578	543	4	0.23	2.94	4.37	2.87	142	138
600		200	5	4 820	8 110	444	430	570	24080R	24080RK30	422	450	578	531	4	0.32	2.09	3.12	2.05	206	203
600		200	5	4 620	8 140	535	420	570	24080RHA	24080RHAK30	422	450	578	534	4	0.31	2.21	3.29	2.16	192	189
650		200	6	4 730	7 780	521	390	520	23180R	23180RK	428	476	622	564	5	0.31	2.19	3.25	2.14	273	265

[Remark] Standard cage types used for the above bearings are shown in Table 5 earlier in this section.

Spherical roller bearings

d (400) ~ (460) mm

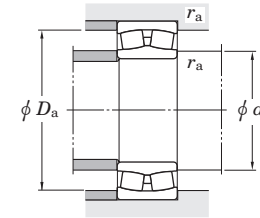
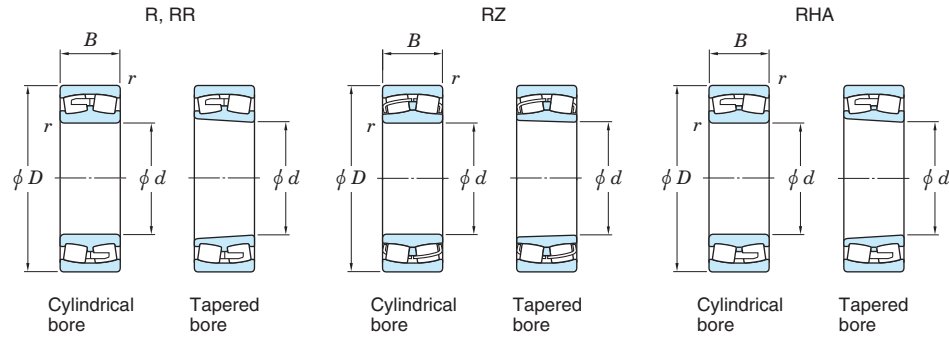

Boundary dimensions (mm)				Basic load ratings (kN)		Fatigue load limit (kN)	Limiting speeds (min ⁻¹)		Bearing No.		Mounting dimensions (mm)					Constant	Axial load factors			(Refer.) Mass (kg)	
d	D	B	r _{min.}	C _r	C _{0r}	C _u	Grease lub.	Oil lub.	Cylindrical bore	Tapered bore	d _a min.	d _a max.	D _a max.	D _a min.	r _a max.	e	Y ₁	Y ₂	Y ₀	Cylindrical bore	Tapered bore
400	650	200	6	5 410	8 300	542	390	520	23180RHA	23180RHAK	428	473	622	574	5	0.29	2.30	3.43	2.25	255	247
	650	250	6	5 840	9 140	499	390	530	24180R	24180RK30	428	461	622	558	5	0.37	1.82	2.70	1.78	338	333
	650	250	6	6 290	10 600	600	390	520	24180RHA	24180RHAK30	428	462	622	558	5	0.37	1.82	2.71	1.78	322	317
	720	256	6	6 540	9 850	590	350	470	23280R	23280RK	428	496	692	605	5	0.37	1.80	2.69	1.76	468	454
	720	256	6	7 320	10 600	665	350	460	23280RHA	23280RHAK	428	489	692	619	5	0.35	1.92	2.86	1.88	441	427
420	560	106	4	2 330	4 320	331	430	580	23984R	23984RK	438	465	542	522	3	0.17	3.91	5.82	3.82	76.0	73.6
	620	150	5	3 500	6 120	412	400	530	23084R	23084RK	442	483	598	560	4	0.23	2.90	4.31	2.83	164	159
	620	150	5	3 820	6 230	425	400	530	23084RHA	23084RHAK	442	480	598	563	4	0.22	3.02	4.49	2.95	150	145
	620	200	5	4 510	7 600	438	400	530	24084R	24084RK30	442	471	598	554	4	0.30	2.23	3.32	2.18	212	209
	620	200	5	4 730	8 490	555	400	530	24084RHA	24084RHAK30	442	471	598	554	4	0.29	2.31	3.44	2.26	198	195
	700	224	6	5 620	9 110	583	350	470	23184R	23184RK	448	506	672	604	5	0.33	2.03	3.02	1.98	363	352
	700	224	6	6 330	9 630	616	350	470	23184RHA	23184RHAK	448	500	672	615	5	0.31	2.19	3.25	2.14	339	328
	700	280	6	6 840	10 600	574	360	480	24184R	24184RK30	448	486	672	593	5	0.40	1.71	2.54	1.67	445	438
	700	280	6	7 420	12 400	685	350	470	24184RHA	24184RHAK30	448	486	672	596	5	0.39	1.72	2.56	1.68	425	418
	760	272	7.5	8 130	11 500	754	320	430	23284R	23284RK	456	514	724	652	6	0.37	1.84	2.74	1.80	556	540
760	272	7.5	8 230	11 900	735	320	430	23284RHA	23284RHAK	456	512	724	652	6	0.36	1.90	2.83	1.86	525	508	
440	600	118	4	2 910	5 330	387	400	530	23988R	23988RK	458	490	582	554	3	0.18	3.75	5.58	3.66	101	97.8
	650	157	6	3 790	6 540	455	370	500	23088R	23088RK	468	501	622	584	5	0.24	2.76	4.11	2.70	188	183
	650	157	6	4 230	6 910	465	370	490	23088RHA	23088RHAK	468	504	622	591	5	0.22	3.04	4.53	2.97	172	167
	650	212	6	4 910	8 320	475	370	490	24088R	24088RK30	468	494	622	579	5	0.29	2.35	3.50	2.30	247	243
	650	212	6	5 290	9 560	618	370	490	24088RHA	24088RHAK30	468	492	622	575	5	0.30	2.28	3.39	2.23	231	227
	720	226	6	5 800	9 600	591	330	440	23188R	23188RK	468	526	692	625	5	0.33	2.08	3.09	2.03	378	366
	720	226	6	6 590	10 300	655	330	440	23188RHA	23188RHAK	468	521	692	636	5	0.30	2.25	3.34	2.20	353	341
	720	280	6	7 080	11 200	589	340	450	24188R	24188RK30	468	507	692	615	5	0.38	1.76	2.62	1.72	460	453
	720	280	6	7 540	12 900	707	330	440	24188RHA	24188RHAK30	468	509	692	616	5	0.38	1.79	2.67	1.75	439	432
	790	280	7.5	8 580	12 300	793	300	400	23288R	23288RK	476	540	754	684	6	0.36	1.86	2.77	1.82	613	595
	790	280	7.5	8 670	12 700	776	300	390	23288RHA	23288RHAK	476	539	754	682	6	0.35	1.93	2.88	1.89	580	562
460	600	90	3	1 800	3 660	306	350	460	23896R	23896RK	476	519	586	568	2.5	0.13	5.06	7.53	4.95	60.4	58.4

[Remark] Standard cage types used for the above bearings are shown in Table 5 earlier in this section.

Spherical roller bearings

d (460) ~ 500 mm

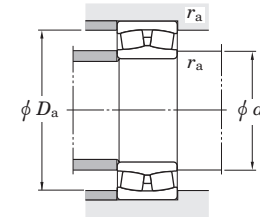
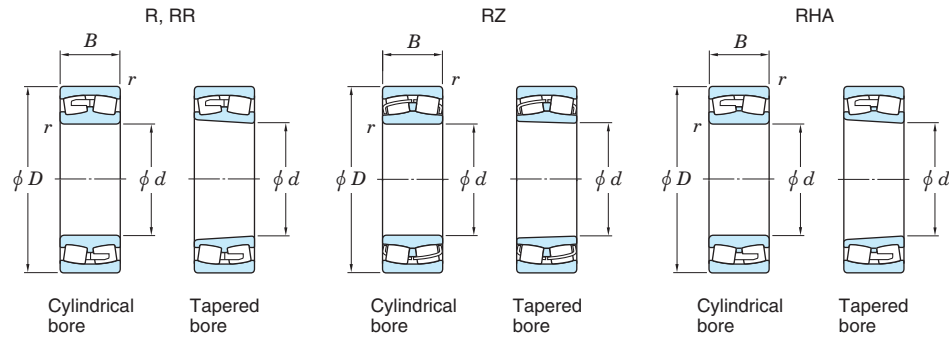

Boundary dimensions (mm)				Basic load ratings (kN)		Fatigue load limit (kN)	Limiting speeds (min ⁻¹)		Bearing No.		Mounting dimensions (mm)					Constant	Axial load factors			(Refer.) Mass (kg)	
d	D	B	$r_{min.}$	C_r	C_{0r}	C_u	Grease lub.	Oil lub.	Cylindrical bore	Tapered bore	d_a min.	d_a max.	D_a max.	D_a min.	r_a max.	e	Y_1	Y_2	Y_0	Cylindrical bore	Tapered bore
460	620	118	4	2 890	5 350	404	370	500	23992R	23992RK	478	512	602	577	3	0.17	3.89	5.79	3.80	107	104
	680	163	6	4 060	7 170	480	340	460	23092R	23092RK	488	529	652	613	5	0.23	2.92	4.34	2.85	215	209
	680	163	6	4 520	7 430	497	340	460	23092RHA	23092RHAK	488	527	652	618	5	0.22	3.04	4.53	2.97	197	191
	680	218	6	5 740	10 100	536	340	460	24092R	24092RK30	488	519	652	607	5	0.30	2.23	3.32	2.18	277	272
	680	218	6	5 660	10 300	656	340	460	24092RHA	24092RHAK30	488	518	652	604	5	0.29	2.33	3.46	2.27	259	254
	760	240	7.5	6 510	10 800	648	310	410	23192R	23192RK	496	552	724	656	6	0.33	2.07	3.09	2.03	450	436
	760	240	7.5	7 240	11 200	697	300	400	23192RHA	23192RHAK	496	546	724	669	6	0.30	2.22	3.31	2.17	420	406
	760	300	7.5	7 320	12 200	597	310	410	24192R	24192RK30	496	537	724	647	6	0.35	1.95	2.90	1.91	550	541
	760	300	7.5	8 390	14 200	746	310	410	24192RHA	24192RHAK30	496	535	724	651	6	0.38	1.75	2.61	1.72	525	516
	830	296	7.5	9 520	13 700	867	270	370	23292R	23292RK	496	567	794	718	6	0.36	1.85	2.76	1.81	720	699
	830	296	7.5	9 600	14 200	856	270	360	23292RHA	23292RHAK	496	564	794	714	6	0.35	1.92	2.85	1.87	679	658
	480	650	128	5	3 290	6 130	446	350	460	23996R	23996RK	502	534	628	603	4	0.18	3.75	5.59	3.67	123
700		165	6	4 190	7 540	505	320	430	23096R	23096RK	508	549	672	633	5	0.22	3.01	4.47	2.94	225	218
700		165	6	4 670	7 860	532	320	430	23096RHA	23096RHAK	508	548	672	639	5	0.22	3.12	4.64	3.05	206	199
700		218	6	5 540	9 650	514	320	430	24096R	24096RK30	508	539	672	626	5	0.29	2.32	3.45	2.26	287	282
700		218	6	5 800	10 700	492	320	430	24096RHA	24096RHAK30	508	537	672	626	5	0.28	2.41	3.59	2.35	268	263
790		248	7.5	6 840	11 500	698	280	380	23196R	23196RK	516	579	754	685	6	0.32	2.09	3.12	2.05	503	488
790		248	7.5	7 740	12 000	638	280	380	23196RHA	23196RHAK	516	570	754	697	6	0.30	2.24	3.34	2.19	470	455
790		308	7.5	8 730	14 800	707	280	380	24196R	24196RK30	516	560	754	678	6	0.39	1.74	2.59	1.70	606	597
790		308	7.5	9 880	15 900	792	290	380	24196RHA	24196RHAK30	516	553	754	684	6	0.38	1.78	2.65	1.74	580	568
870		310	7.5	10 500	15 100	953	250	340	23296R	23296RK	516	588	834	745	6	0.36	1.85	2.75	1.81	831	807
870		310	7.5	10 600	15 700	791	250	340	23296RHA	23296RHAK	516	589	834	748	6	0.35	1.91	2.85	1.87	785	761
500		670	128	5	3 330	6 310	447	330	440	239/500R	239/500RK	522	553	648	622	4	0.17	3.87	5.76	3.79	131
	720	167	6	4 490	8 090	561	310	410	230/500R	230/500RK	528	568	692	656	5	0.23	2.94	4.37	2.87	235	228
	720	218	6	5 620	10 300	545	310	410	240/500R	240/500RK30	528	561	692	647	5	0.28	2.39	3.56	2.34	297	292
	830	264	7.5	7 750	13 000	708	260	350	231/500R	231/500RK	536	601	794	714	6	0.33	2.05	3.05	2.00	595	577
	830	325	7.5	9 350	15 900	763	260	350	241/500R	241/500RK30	536	591	794	712	6	0.36	1.85	2.76	1.81	712	701
	920	336	7.5	11 000	16 700	908	230	310	232/500R	232/500RK	536	622	884	774	6	0.39	1.74	2.59	1.70	1 020	992

[Remark] Standard cage types used for the above bearings are shown in Table 5 earlier in this section.

Adapter assemblies for spherical roller bearings

d_1 20 ~ 65 mm

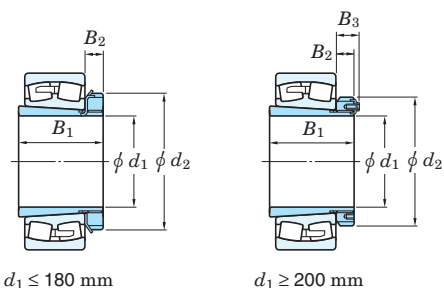

d_1 70 ~ 110 mm

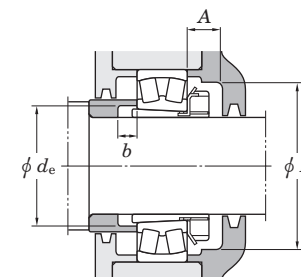

Boundary dimensions (mm)					Brg. bore d (mm)	Designations Bearing + adapter ass'y	Mounting dimensions (mm)				Mass Brg.+adapter ass'y (kg)	(Refer.)	
d_1	B_1	d_2	B_2	B_3			A min.	K min.	d_e min.	b min.		Adapter sleeve No.	Locknut No.
20	29	38	8	—	25	22205RZK+H305X	15	45	29	5	0.269	A305X	AN05
25	31	45	8	—	30	22206RZK+H306X	15	50	34	5	0.404	A306X	AN06
	31	45	8	—	30	21306RZK+H306X	15	50	34	6	0.538	A306X	AN06
30	35	52	9	—	35	22207RZK+H307X	17	58	39	5	0.610	A307X	AN07
	35	52	9	—	35	21307RZK+H307X	17	58	39	7	0.725	A307X	AN07
35	36	58	10	—	40	22208RZK+H308X	17	65	44	5	0.793	A308X	AN08
	36	58	10	—	40	21308RZK+H308X	17	65	44	5	0.972	A308X	AN08
	46	58	10	—	40	22308RZK+H2308X	17	65	45	5	1.30	A2308X	AN08
40	39	65	11	—	45	22209RZK+H309X	17	72	49	8	0.855	A309X	AN09
	39	65	11	—	45	21309RZK+H309X	17	72	49	5	1.31	A309X	AN09
	50	65	11	—	45	22309RZK+H2309X	17	72	50	5	1.70	A2309X	AN09
45	42	70	12	—	50	22210RZK+H310X	19	76	54	10	0.953	A310X	AN10
	42	70	12	—	50	21310RZK+H310X	19	76	54	5	1.67	A310X	AN10
	55	70	12	—	50	22310RZK+H2310X	19	76	56	5	2.26	A2310X	AN10
50	45	75	12	—	55	22211RZK+H311X	19	85	60	11	1.22	A311X	AN11
	45	75	12	—	55	21311RZK+H311X	19	85	60	6	2.04	A311X	AN11
	59	75	12	—	55	22311RZK+H2311X	19	85	61	6	2.80	A2311X	AN11
55	47	80	13	—	60	22212RZK+H312X	20	90	65	9	1.59	A312X	AN12
	47	80	13	—	60	21312RZK+H312X	20	90	65	5	2.50	A312X	AN12
	62	80	13	—	60	22312RZK+H2312X	20	90	66	5	3.50	A2312X	AN12
60	50	85	14	—	65	22213RZK+H313X	21	96	70	8	2.01	A313X	AN13
	50	85	14	—	65	21313RZK+H313X	21	96	70	5	3.07	A313X	AN13
	65	85	14	—	65	22313RZK+H2313X	21	96	72	5	4.17	A2313X	AN13
65	55	98	15	—	75	22215RZK+H315X	23	110	80	12	2.58	A315X	AN15
	55	98	15	—	75	21315RZK+H315X	23	110	80	5	4.65	A315X	AN15
	73	98	15	—	75	22315RZK+H2315X	23	110	82	5	6.44	A2315X	AN15

Boundary dimensions (mm)					Brg. bore d (mm)	Designations Bearing + adapter ass'y	Mounting dimensions (mm)				Mass Brg.+adapter ass'y (kg)	(Refer.)	
d_1	B_1	d_2	B_2	B_3			A min.	K min.	d_e min.	b min.		Adapter sleeve No.	Locknut No.
70	59	105	17	—	80	22216RZK+H316X	25	120	86	12	3.22	A316X	AN16
	59	105	17	—	80	21316RZK+H316X	25	120	86	5	5.56	A316X	AN16
	78	105	17	—	80	22316RZK+H2316X	25	120	87	5	7.64	A2316X	AN16
75	63	110	18	—	85	22217RZK+H317X	27	128	91	12	3.93	A317X	AN17
	63	110	18	—	85	21317RZK+H317X	27	128	91	6	6.49	A317X	AN17
	82	110	18	—	85	22317RZK+H2317X	27	128	94	6	8.83	A2317X	AN17
80	65	120	18	—	90	22218RZK+H318X	28	139	96	10	4.88	A318X	AN18
	86	120	18	—	90	23218RZK+H2318X	28	139	99	18	6.20	A2318X	AN18
	65	120	18	—	90	21318RZK+H318X	28	139	96	6	7.56	A318X	AN18
	86	120	18	—	90	22318RZK+H2318X	28	139	99	6	10.3	A2318X	AN18
85	68	125	19	—	95	22219RZK+H319X	29	145	102	9	5.77	A319X	AN19
	68	125	19	—	95	21319RZK+H319X	29	145	102	7	8.68	A319X	AN19
	90	125	19	—	95	22319RZK+H2319X	29	145	105	7	12.0	A2319X	AN19
90	71	130	20	—	100	22220RZK+H320X	30	150	107	8	6.80	A320X	AN20
	97	130	20	—	100	23220RZK+H2320X	30	150	110	19	8.94	A2320X	AN20
	71	130	20	—	100	21320RZK+H320X	30	150	107	7	10.5	A320X	AN20
	97	130	20	—	100	22320RZK+H2320X	30	150	110	7	15.2	A2320X	AN20
100	81	145	21	—	110	23122RZK+H3122X	32	170	117	7	7.91	A3122X	AN22
	77	145	21	—	110	22222RZK+H3222X	32	170	117	6	9.50	A322X	AN22
	105	145	21	—	110	23222RZK+H2322X	32	170	121	17	12.4	A2322X	AN22
	77	145	21	—	110	21322RZK+H3222X	32	170	117	9	14.0	A322X	AN22
	105	145	21	—	110	22322RZK+H2322X	32	170	121	7	20.6	A2322X	AN22
110	72	145	22	—	120	23024RZK+H3024X	33	180	127	7	6.12	A3024	ANL24
	88	155	22	—	120	23124RZK+H3124X	33	180	128	7	10.5	A3124	AN24
	88	155	22	—	120	22224RZK+H3124X	33	180	128	11	11.9	A3124	AN24
	112	155	22	—	120	23224RZK+H2324X	33	180	131	17	15.1	A2324	AN24
	112	155	22	—	120	22324RZK+H2324X	33	180	131	7	25.6	A2324	AN24

Adapter assemblies for spherical roller bearings

d_1 115 ~ (150) mm

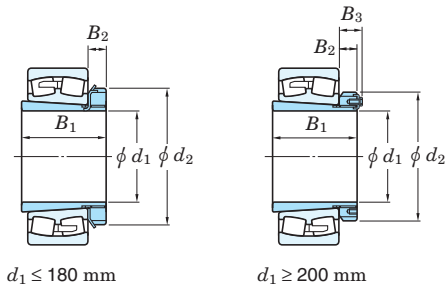

d_1 (150) ~ (180) mm

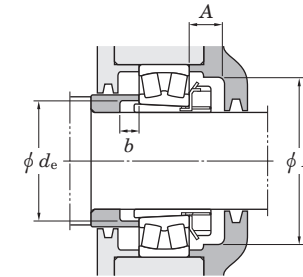

Boundary dimensions (mm)					Brg. bore d (mm)	Designations Bearing + adapter ass'y	Mounting dimensions (mm)				Mass Brg.+adapter ass'y (kg)	(Refer.)	
d_1	B_1	d_2	B_2	B_3			A min.	K min.	d_e min.	b min.		Adapter sleeve No.	Locknut No.
115	80	155	23	—	130	23026RZK+H3026	34	190	137	8	9.01	A3026	ANL26
	92	165	23	—	130	23126RZK+H3126	34	190	138	8	12.3	A3126	AN26
	92	165	23	—	130	22226RZK+H3126	34	190	138	8	15.1	A3126	AN26
	121	165	23	—	130	23226RZK+H2326	34	190	142	21	18.8	A2326	AN26
	121	165	23	—	130	22326RZK+H2326	34	190	142	8	32.7	A2326	AN26
125	82	165	24	—	140	23028RZK+H3028	36	205	147	8	9.79	A3028	ANL28
	97	180	24	—	140	23128RZK+H3128	36	205	149	8	14.9	A3128	AN28
	97	180	24	—	140	22228RZK+H3128	36	205	149	8	18.8	A3128	AN28
	131	180	24	—	140	23228RZK+H2328	36	205	152	22	24.3	A2328	AN28
	131	180	24	—	140	22328RZK+H2328	36	205	152	8	40.8	A2328	AN28
135	87	180	26	—	150	23030RZK+H3030	37	220	158	8	11.9	A3030	ANL30
	111	195	26	—	150	23130RZK+H3130	37	220	160	8	21.7	A3130	AN30
	111	195	26	—	150	22230RZK+H3130	37	220	160	15	24.3	A3130	AN30
	139	195	26	—	150	23230RZK+H2330	37	220	163	20	30.8	A2330	AN30
	139	195	26	—	150	22330RK+H2330	37	220	163	8	49.7	A2330	AN30
140	93	190	28	—	160	23032RZK+H3032	39	230	168	8	15.0	A3032	ANL32
	119	210	28	—	160	23132RZK+H3132	39	230	170	8	27.9	A3132	AN32
	119	210	28	—	160	22232RK+H3132	39	230	170	14	30.6	A3132	AN32
	119	210	28	—	160	22232RHAK+H3132	39	230	170	14	29.1	A3132	AN32
	147	210	28	—	160	23232RK+H2332	39	230	174	18	39.6	A2332	AN32
	147	210	28	—	160	23232RHAK+H2332	39	230	174	18	38.0	A2332	AN32
	147	210	28	—	160	22332RK+H2332	39	230	174	8	60.5	A2332	AN32
	147	210	28	—	160	22332RHAK+H2332	39	230	174	8	56.6	A2332	AN32
	150	101	200	29	—	170	23034RZK+H3034	40	250	179	8	19.2	A3034
122		220	29	—	170	23134RZK+H3134	40	250	180	8	30.0	A3134	AN34
122		220	29	—	170	22234RK+H3134	40	250	180	10	37.2	A3134	AN34
122		220	29	—	170	22234RHAK+H3134	40	250	180	10	35.3	A3134	AN34

Boundary dimensions (mm)					Brg. bore d (mm)	Designations Bearing + adapter ass'y	Mounting dimensions (mm)				Mass Brg.+adapter ass'y (kg)	(Refer.)		
d_1	B_1	d_2	B_2	B_3			A min.	K min.	d_e min.	b min.		Adapter sleeve No.	Locknut No.	
150	154	220	29	—	170	23234RRK+H2334	40	250	185	18	47.2	A2334	AN34	
	154	220	29	—	170	23234RHAK+H2334	40	250	185	18	45.3	A2334	AN34	
	154	220	29	—	170	22334RK+H2334	40	250	185	8	71.5	A2334	AN34	
	154	220	29	—	170	22334RHAK+H2334	40	250	185	8	66.8	A2334	AN34	
160	109	210	30	—	180	23036RZK+H3036	41	260	189	8	24.2	A3036	ANL36	
	131	230	30	—	180	23136RK+H3136	41	260	191	8	37.1	A3136	AN36	
	131	230	30	—	180	23136RHAK+H3136	41	260	191	8	35.2	A3136	AN36	
	131	230	30	—	180	22236RK+H3136	41	260	191	18	39.4	A3136	AN36	
	131	230	30	—	180	22236RHAK+H3136	41	260	191	18	37.4	A3136	AN36	
	161	230	30	—	180	23236RRK+H2336	41	260	195	22	50.5	A2336	AN36	
	161	230	30	—	180	23236RHAK+H2336	41	260	195	22	48.4	A2336	AN36	
	161	230	30	—	180	22336RK+H2336	41	260	195	8	81.8	A2336	AN36	
170	112	220	31	—	190	23038RK+H3038	43	270	199	9	26.1	A3038	ANL38	
	112	220	31	—	190	23038RHAK+H3038	43	270	199	9	24.5	A3038	ANL38	
	141	240	31	—	190	23138RK+H3138	43	270	202	9	45.3	A3138	AN38	
	141	240	31	—	190	23138RHAK+H3138	43	270	202	9	43.0	A3138	AN38	
	141	240	31	—	190	22238RK+H3138	43	270	202	21	47.5	A3138	AN38	
	141	240	31	—	190	22238RHAK+H3138	43	270	202	21	45.0	A3138	AN38	
	169	240	31	—	190	23238RRK+H2338	43	270	206	21	59.2	A2338	AN38	
	169	240	31	—	190	23238RHAK+H2338	43	270	206	21	56.7	A2338	AN38	
	169	240	31	—	190	22338RK+H2338	43	270	206	9	95.6	A2338	AN38	
	169	240	31	—	190	22338RHAK+H2338	43	270	206	9	89.2	A2338	AN38	
	180	120	240	32	—	200	23040RK+H3040	46	280	210	10	32.8	A3040	ANL40
		120	240	32	—	200	23040RHAK+H3040	46	280	210	10	30.7	A3040	ANL40
150		250	32	—	200	23140RRK+H3140	46	280	212	10	54.7	A3140	AN40	
150		250	32	—	200	23140RHAK+H3140	46	280	212	10	51.8	A3140	AN40	
150		250	32	—	200	22240RRK+H3140	46	280	212	24	56.3	A3140	AN40	

Adapter assemblies for spherical roller bearings

d_1 (180) ~ (240) mm

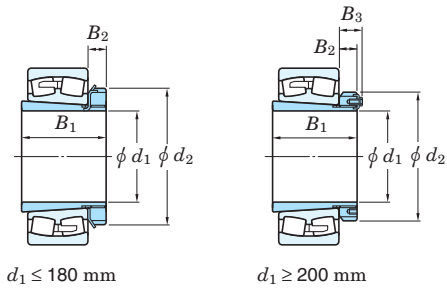

d_1 (240) ~ (300) mm

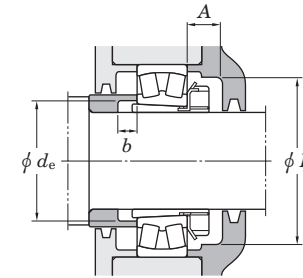

Boundary dimensions (mm)					Brg. bore d (mm)	Designations Bearing + adapter ass'y	Mounting dimensions (mm)				Mass Brg.+adapter ass'y (kg)	(Refer.)		
d_1	B_1	d_2	B_2	B_3			A min.	K min.	d_e min.	b min.		Adapter sleeve No.	Locknut No.	
180	150	250	32	—	200	22240RHAK+H3140	46	280	212	24	53.3	A3140	AN40	
	176	250	32	—	200	23240RK+H2340	46	280	216	20	71.0	A2340	AN40	
	176	250	32	—	200	23240RHAK+H2340	46	280	216	20	68.0	A2340	AN40	
	176	250	32	—	200	22340RK+H2340	46	280	216	10	108	A2340	AN40	
	176	250	32	—	200	22340RHAK+H2340	46	280	216	10	101	A2340	AN40	
	200	128	260	30	41	220	23044RK+H3044	—	—	231	12	41.4	A3044	ANL44
128		260	30	41	220	23044RHAK+H3044	—	—	231	12	38.7	A3044	ANL44	
158		280	32	44	220	23144RK+H3144	—	—	233	10	68.4	A3144	AN44	
158		280	32	44	220	23144RHAK+H3144	—	—	233	10	64.8	A3144	AN44	
158		280	32	44	220	22244RRK+H3144	—	—	233	22	76.9	A3144	AN44	
158		280	32	44	220	22244RHAK+H3144	—	—	233	22	72.7	A3144	AN44	
183		280	32	44	220	23244RK+H2344	—	—	236	11	96.5	A2344	AN44	
183		280	32	44	220	23244RHAK+H2344	—	—	236	11	92.3	A2344	AN44	
183		280	32	44	220	22344RK+H2344	—	—	236	10	139	A2344	AN44	
183		280	32	44	220	22344RHAK+H2344	—	—	236	10	130	A2344	AN44	
220		133	290	34	46	240	23048RRK+H3048	—	—	251	11	47.7	A3048	ANL48
		133	290	34	46	240	23048RHAK+H3048	—	—	251	11	44.8	A3048	ANL48
	169	300	34	46	240	23148RRK+H3148	—	—	254	11	83.6	A3148	AN48	
	169	300	34	46	240	23148RHAK+H3148	—	—	254	11	79.1	A3148	AN48	
	169	300	34	46	240	22248RK+H3148	—	—	254	19	101	A3148	AN48	
	169	300	34	46	240	22248RHAK+H3148	—	—	254	19	95.6	A3148	AN48	
	196	300	34	46	240	23248RRK+H2348	—	—	257	6	128	A2348	AN48	
	196	300	34	46	240	23248RHAK+H2348	—	—	257	6	122	A2348	AN48	
	196	300	34	46	240	22348RK+H2348	—	—	257	11	175	A2348	AN48	
	196	300	34	46	240	22348RHAK+H2348	—	—	257	11	163	A2348	AN48	
	240	147	310	34	46	260	23052RK+H3052	—	—	272	13	65.4	A3052	ANL52
		147	310	34	46	260	23052RHAK+H3052	—	—	272	13	61.0	A3052	ANL52
187		330	36	49	260	23152RRK+H3152	—	—	276	11	114	A3152	AN52	

Boundary dimensions (mm)					Brg. bore d (mm)	Designations Bearing + adapter ass'y	Mounting dimensions (mm)				Mass Brg.+adapter ass'y (kg)	(Refer.)		
d_1	B_1	d_2	B_2	B_3			A min.	K min.	d_e min.	b min.		Adapter sleeve No.	Locknut No.	
240	187	330	36	49	260	23152RHAK+H3152	—	—	276	11	108	A3152	AN52	
	187	330	36	49	260	22252RK+H3152	—	—	276	25	131	A3152	AN52	
	187	330	36	49	260	22252RHAK+H3152	—	—	276	25	124	A3152	AN52	
	208	330	36	49	260	23252RK+H2352	—	—	278	2	165	A2352	AN52	
	208	330	36	49	260	23252RHAK+H2352	—	—	278	2	158	A2352	AN52	
	208	330	36	49	260	22352RK+H2352	—	—	278	11	217	A2352	AN52	
	208	330	36	49	260	22352RHAK+H2352	—	—	278	11	202	A2352	AN52	
	260	152	330	38	50	280	23056RK+H3056	—	—	292	12	71.5	A3056	ANL56
		152	330	38	50	280	23056RHAK+H3056	—	—	292	12	66.8	A3056	ANL56
		192	350	38	51	280	23156RRK+H3156	—	—	296	12	123	A3156	AN56
192		350	38	51	280	23156RHAK+H3156	—	—	296	12	116	A3156	AN56	
192		350	38	51	280	22256RK+H3156	—	—	296	28	138	A3156	AN56	
192		350	38	51	280	22256RHAK+H3156	—	—	296	28	130	A3156	AN56	
221		350	38	51	280	23256RK+H2356	—	—	299	11	178	A2356	AN56	
221		350	38	51	280	23256RHAK+H2356	—	—	299	11	170	A2356	AN56	
221		350	38	51	280	22356RK+H2356	—	—	299	12	254	A2356	AN56	
221		350	38	51	280	22356RHAK+H2356	—	—	299	12	237	A2356	AN56	
280	168	360	42	54	300	23060RK+H3060	—	—	313	12	97.7	A3060	ANL60	
	168	360	42	54	300	23060RHAK+H3060	—	—	313	12	90.8	A3060	ANL60	
	208	380	40	53	300	23160RRK+H3160	—	—	317	12	159	A3160	AN60	
	208	380	40	53	300	23160RHAK+H3160	—	—	317	12	150	A3160	AN60	
	208	380	40	53	300	22260RK+H3160	—	—	317	32	173	A3160	AN60	
	208	380	40	53	300	22260RHAK+H3160	—	—	317	32	163	A3160	AN60	
	240	380	40	53	300	23260RK+H3260	—	—	321	12	227	A3260	AN60	
	240	380	40	53	300	23260RHAK+H3260	—	—	321	12	217	A3260	AN60	
	300	171	380	42	55	320	23064RK+H3064	—	—	334	13	105	A3064	ANL64
		171	380	42	55	320	23064RHAK+H3064	—	—	334	13	98.1	A3064	ANL64
226		400	42	56	320	23164RK+H3164	—	—	339	13	202	A3164	AN64	

Adapter assemblies for spherical roller bearings

d_1 (300) ~ 380 mm

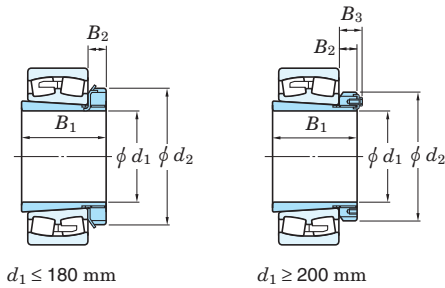

d_1 400 ~ 470 mm

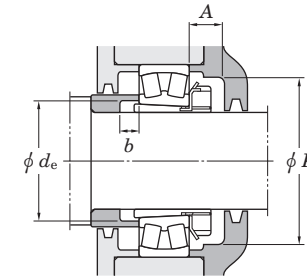

Boundary dimensions (mm)					Brg. bore d (mm)	Designations Bearing + adapter ass'y	Mounting dimensions (mm)				Mass Brg.+adapter ass'y (kg)	(Refer.)	
d_1	B_1	d_2	B_2	B_3			A min.	K min.	d_e min.	b min.		Adapter sleeve No.	Locknut No.
300	226	400	42	56	320	23164RHAK+H3164	—	—	339	13	191	A3164	AN64
	226	400	42	56	320	22264RK+H3164	—	—	339	39	207	A3164	AN64
	258	400	42	56	320	23264RK+H3264	—	—	343	13	283	A3264	AN64
	258	400	42	56	320	23264RHAK+H3264	—	—	343	13	270	A3264	AN64
320	187	400	45	58	340	23068RK+H3068	—	—	355	14	135	A3068	ANL68
	187	400	45	58	340	23068RHAK+H3068	—	—	355	14	126	A3068	ANL68
	254	440	55	72	340	23168RK+H3168	—	—	360	14	262	A3168	AN68
	254	440	55	72	340	23168RHAK+H3168	—	—	360	14	248	A3168	AN68
	288	440	55	72	340	23268RK+H3268	—	—	364	14	355	A3268	AN68
	288	440	55	72	340	23268RHAK+H3268	—	—	364	14	339	A3268	AN68
340	188	420	45	58	360	23072RK+H3072	—	—	375	14	143	A3072	ANL72
	188	420	45	58	360	23072RHAK+H3072	—	—	375	14	133	A3072	ANL72
	259	460	58	75	360	23172RK+H3172	—	—	380	14	278	A3172	AN72
	259	460	58	75	360	23172RHAK+H3172	—	—	380	14	263	A3172	AN72
	299	460	58	75	360	23272RK+H3272	—	—	385	14	400	A3272	AN72
	299	460	58	75	360	23272RHAK+H3272	—	—	385	14	382	A3272	AN72
360	193	450	48	62	380	23076RK+H3076	—	—	396	15	156	A3076	ANL76
	193	450	48	62	380	23076RHAK+H3076	—	—	396	15	146	A3076	ANL76
	264	490	60	77	380	23176RK+H3176	—	—	401	15	298	A3176	AN76
	264	490	60	77	380	23176RHAK+H3176	—	—	401	15	282	A3176	AN76
	310	490	60	77	380	23276RK+H3276	—	—	405	15	448	A3276	AN76
	310	490	60	77	380	23276RHAK+H3276	—	—	405	15	427	A3276	AN76
380	210	470	52	66	400	23080RK+H3080	—	—	417	15	195	A3080	ANL80
	210	470	52	66	400	23080RHAK+H3080	—	—	417	15	182	A3080	ANL80
	272	520	62	82	400	23180RK+H3180	—	—	421	15	339	A3180	AN80
	272	520	62	82	400	23180RHAK+H3180	—	—	421	15	321	A3180	AN80
	328	520	62	82	400	23280RK+H3280	—	—	427	15	539	A3280	AN80
	328	520	62	82	400	23280RHAK+H3280	—	—	427	15	512	A3280	AN80

Boundary dimensions (mm)					Brg. bore d (mm)	Designations Bearing + adapter ass'y	Mounting dimensions (mm)				Mass Brg.+adapter ass'y (kg)	(Refer.)	
d_1	B_1	d_2	B_2	B_3			A min.	K min.	d_e min.	b min.		Adapter sleeve No.	Locknut No.
400	212	490	52	66	420	23084RK+H3084	—	—	437	16	205	A3084	ANL84
	212	490	52	66	420	23084RHAK+H3084	—	—	437	16	191	A3084	ANL84
	304	540	70	90	420	23184RK+H3184	—	—	443	16	441	A3184	AN84
	304	540	70	90	420	23184RHAK+H3184	—	—	443	16	417	A3184	AN84
	352	540	70	90	420	23284RK+H3284	—	—	448	16	639	A3284	AN84
	352	540	70	90	420	23284RHAK+H3284	—	—	448	16	607	A3284	AN84
410	228	520	60	77	440	23088RK+H3088	—	—	458	17	252	A3088	ANL88
	228	520	60	77	440	23088RHAK+H3088	—	—	458	17	236	A3088	ANL88
	307	560	70	90	440	23188RK+H3188	—	—	464	17	474	A3188	AN88
	307	560	70	90	440	23188RHAK+H3188	—	—	464	17	449	A3188	AN88
	361	560	70	90	440	23288RK+H3288	—	—	469	17	718	A3288	AN88
	361	560	70	90	440	23288RHAK+H3288	—	—	469	17	685	A3288	AN88
430	234	540	60	77	460	23092RK+H3092	—	—	478	17	283	A3092	ANL92
	234	540	60	77	460	23092RHAK+H3092	—	—	478	17	265	A3092	ANL92
	326	580	75	95	460	23192RK+H3192	—	—	485	17	559	A3192	AN92
	326	580	75	95	460	23192RHAK+H3192	—	—	485	17	529	A3192	AN92
	382	580	75	95	460	23292RK+H3292	—	—	491	17	838	A3292	AN92
	382	580	75	95	460	23292RHAK+H3292	—	—	491	17	797	A3292	AN92
450	237	560	60	77	480	23096RK+H3096	—	—	499	18	295	A3096	ANL96
	237	560	60	77	480	23096RHAK+H3096	—	—	499	18	276	A3096	ANL96
	335	620	75	95	480	23196RK+H3196	—	—	505	18	628	A3196	AN96
	335	620	75	95	480	23196RHAK+H3196	—	—	505	18	595	A3196	AN96
	397	620	75	95	480	23296RK+H3296	—	—	512	18	966	A3296	AN96
	397	620	75	95	480	23296RHAK+H3296	—	—	512	18	920	A3296	AN96
470	247	580	68	85	500	230/500RK+H30/500	—	—	519	18	315	A30/500	ANL100
	356	630	80	100	500	231/500RK+H31/500	—	—	527	18	727	A31/500	AN100
	428	630	80	100	500	232/500RK+H32/500	—	—	534	18	1 167	A32/500	AN100

Withdrawal sleeves for spherical roller bearings

d_1 35 ~ (75) mm

d_1 (75) ~ (115) mm

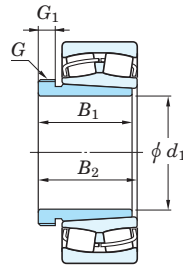

d_1	Boundary dimensions (mm)			G_1	Brg. bore d (mm)	Designations Bearing + withdrawal sleeve	Mass Brg.+withdrawal sleeve (kg)	(Refer.) Applicable locknut No.
	B_1	B_2	$G^{1)}$ Screw size					
35	29	32	M45×1.5	6	40	22208RZK+AH308	0.681	AN09
	29	32	M45×1.5	6	40	21308RZK+AH308	0.860	AN09
	40	43	M45×1.5	7	40	22308RZK+AH2308	1.19	AN09
40	31	34	M50×1.5	6	45	22209RZK+AH309	0.699	AN10
	31	34	M50×1.5	6	45	21309RZK+AH309	1.14	AN10
	44	47	M50×1.5	7	45	22309RZK+AH2309	1.55	AN10
45	35	38	M55×2	7	50	22210RZK+AHX310	0.771	AN11
	35	38	M55×2	7	50	21310RZK+AHX310	1.49	AN11
	50	53	M55×2	9	50	22310RZK+AHX2310	2.09	AN11
50	37	40	M60×2	7	55	22211RZK+AHX311	1.01	AN12
	37	40	M60×2	7	55	21311RZK+AHX311	1.83	AN12
	54	57	M60×2	10	55	22311RZK+AHX2311	2.60	AN12
55	40	43	M65×2	8	60	22212RZK+AHX312	1.35	AN13
	40	43	M65×2	8	60	21312RZK+AHX312	2.27	AN13
	58	61	M65×2	11	60	22312RZK+AHX2312	3.29	AN13
60	42	45	M75×2	8	65	22213RZK+AH313	1.77	AN15
	42	45	M75×2	8	65	21313RZK+AH313	2.84	AN15
	61	64	M75×2	12	65	22313RZK+AH2313	3.98	AN15
65	43	47	M80×2	8	70	22214RZK+AH314	1.89	AN16
	43	47	M80×2	8	70	21314RZK+AH314	3.43	AN16
	64	68	M80×2	12	70	22314RZK+AHX2314	4.82	AN16
70	45	49	M85×2	8	75	22215RZK+AH315	2.01	AN17
	45	49	M85×2	8	75	21315RZK+AH315	4.07	AN17
	68	72	M85×2	12	75	22315RZK+AHX2315	5.87	AN17
75	48	52	M90×2	8	80	22216RZK+AH316	2.49	AN18
	48	52	M90×2	8	80	21316RZK+AH316	4.83	AN18

d_1	Boundary dimensions (mm)			G_1	Brg. bore d (mm)	Designations Bearing + withdrawal sleeve	Mass Brg.+withdrawal sleeve (kg)	(Refer.) Applicable locknut No.
	B_1	B_2	$G^{1)}$ Screw size					
75	71	75	M90×2	12	80	22316RZK+AHX2316	6.90	AN18
80	52	56	M95×2	9	85	22217RZK+AHX317	3.12	AN19
	52	56	M95×2	9	85	21317RZK+AHX317	5.68	AN19
	74	78	M95×2	13	85	22317RZK+AHX2317	7.98	AN19
85	53	57	M100×2	9	90	22218RZK+AHX318	3.89	AN20
	63	67	M100×2	10	90	23218RZK+AHX3218	5.08	AN20
	53	57	M100×2	9	90	21318RZK+AHX318	6.58	AN20
	79	83	M100×2	14	90	22318RZK+AHX2318	9.41	AN20
90	57	61	M105×2	10	95	22219RZK+AHX319	4.68	AN21
	57	61	M105×2	10	95	21319RZK+AHX319	7.59	AN21
	85	89	M105×2	16	95	22319RZK+AHX2319	10.9	AN21
95	59	63	M110×2	10	100	22220RZK+AHX320	5.58	AN22
	73	77	M110×2	11	100	23220RZK+AHX3220	7.43	AN22
	59	63	M110×2	10	100	21320RZK+AHX320	9.26	AN22
	90	94	M110×2	16	100	22320RZK+AHX2320	13.9	AN22
105	68	72	M120×2	11	110	23122RZK+AHX3122	6.30	AN24
	82	91	M115×2	13	110	24122RZK30+AH24122	7.60	AN23
	68	72	M120×2	11	110	22222RZK+AHX3122	7.97	AN24
	82	86	M125×2	11	110	23222RZK+AHX3222	10.5	AN25
	63	67	M120×2	12	110	21322RZK+AHX322	12.3	AN24
115	98	102	M125×2	16	110	22322RZK+AHX2322	19.1	AN25
	60	64	M130×2	13	120	23024RZK+AHX3024	4.82	AN26
	73	82	M125×2	13	120	24024RZK30+AH24024	5.99	AN25
	75	79	M130×2	12	120	23124RZK+AHX3124	8.69	AN26
	93	102	M130×2	13	120	24124RZK30+AH24124	11.0	AN26
75	79	M130×2	12	120	22224RZK+AHX3124	10.1	AN26	

[Note] 1) Basic profile and dimensions of screw thread identified by prefix M are in accordance with JIS B 0205.
Basic profile and dimensions of screw thread identified by prefix Tr are in accordance with JIS B 0216.

Withdrawal sleeves for spherical roller bearings

d_1 (115) ~ (150) mm

d_1 (150) ~ 170 mm

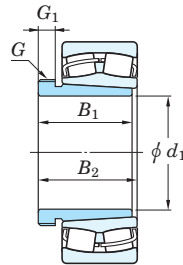

d_1	Boundary dimensions (mm)			G_1	Brg. bore d (mm)	Designations Bearing + withdrawal sleeve	Mass Brg.+withdrawal sleeve (kg)	(Refer.) Applicable locknut No.
	B_1	B_2	$G^{1)}$ Screw size					
115	90	94	M135×2	13	120	23224RZK+ AHX3224	13.1	AN27
	105	109	M135×2	17	120	22324RZK+ AHX2324	23.9	AN27
125	67	71	M140×2	14	130	23026RZK+ AHX3026	6.90	AN28
	83	93	M135×2	14	130	24026RZK30+ AH24026	8.74	AN27
	78	82	M140×2	12	130	23126RZK+ AHX3126	9.52	AN28
	94	104	M140×2	14	130	24126RZK30+ AH24126	11.7	AN28
	78	82	M140×2	12	130	22226RZK+ AHX3126	12.4	AN28
	98	102	M145×2	15	130	23226RZK+ AHX3226	15.6	AN29
	115	119	M145×2	19	130	22326RZK+ AHX2326	29.9	AN29
135	68	73	M150×2	14	140	23028RZK+ AHX3028	7.43	AN30
	83	93	M145×2	14	140	24028RZK30+ AH24028	9.26	AN29
	83	88	M150×2	14	140	23128RZK+ AHX3128	11.5	AN30
	99	109	M150×2	14	140	24128RZK30+ AH24128	14.1	AN30
	83	88	M150×2	14	140	22228RZK+ AHX3128	15.4	AN30
	104	109	M155×3	15	140	23228RZK+ AHX3228	20.3	AN31
	125	130	M155×3	20	140	22328RZK+ AHX2328	35.0	AN31
145	72	77	M160×3	15	150	23030RZK+ AHX3030	8.92	AN32
	90	101	M155×3	15	150	24030RZK30+ AH24030	11.4	AN31
	96	101	M165×3	15	150	23130RZK+ AHX3130	17.7	AN33
	115	126	M160×3	15	150	24130RZK30+ AH24130	21.2	AN32
	96	101	M165×3	15	150	22230RZK+ AHX3130	20.3	AN33
	114	119	M165×3	17	150	23230RZK+ AHX3230	26.0	AN33
	135	140	M165×3	24	150	22330RK+ AHX2330	45.5	AN33
	135	140	M165×3	24	150	22330RHAK+ AHX2330	42.2	AN33
150	77	82	M170×3	16	160	23032RZK+ AHX3032	11.5	AN34
	95	106	M170×3	15	160	24032RZK30+ AH24032	15.0	AN34
	103	108	M180×3	16	160	23132RZK+ AHX3132	23.4	AN36

d_1	Boundary dimensions (mm)			G_1	Brg. bore d (mm)	Designations Bearing + withdrawal sleeve	Mass Brg.+withdrawal sleeve (kg)	(Refer.) Applicable locknut No.
	B_1	B_2	$G^{1)}$ Screw size					
150	103	108	M180×3	16	160	22232RK+ AH3132	26.1	AN36
	103	108	M180×3	16	160	22232RHAK+ AH3132	24.6	AN36
	124	130	M180×3	20	160	23232RK+ AH3232	35.1	AN36
	124	130	M180×3	20	160	23232RHAK+ AH3232	32.6	AN36
	140	146	M180×3	24	160	22332RK+ AH2332	55.7	AN36
	140	146	M180×3	24	160	22332RHAK+ AH2332	51.8	AN36
160	85	90	M180×3	17	170	23034RZK+ AH3034	15.2	AN36
	106	117	M180×3	16	170	24034RZK30+ AH24034	20.0	AN36
	104	109	M190×3	16	170	23134RZK+ AH3134	24.6	AN38
	125	136	M180×3	16	170	24134RRK30+ AH24134	30.0	AN36
	104	109	M190×3	16	170	22234RK+ AH3134	31.8	AN38
	104	109	M190×3	16	170	22234RHAK+ AH3134	29.9	AN38
	134	140	M190×3	24	170	23234RRK+ AH3234	42.3	AN38
	134	140	M190×3	24	170	23234RHAK+ AH3234	39.4	AN38
	146	152	M190×3	24	170	22334RK+ AH2334	66.1	AN38
	146	152	M190×3	24	170	22334RHAK+ AH2334	61.4	AN38
170	92	98	M190×3	17	180	23036RZK+ AH3036	19.7	AN38
	116	127	M190×3	16	180	24036RRK30+ AH24036	26.1	AN38
	116	122	M200×3	19	180	23136RK+ AH3136	31.7	AN40
	116	122	M200×3	19	180	23136RHAK+ AH3136	29.8	AN40
	134	145	M190×3	16	180	24136RRK30+ AH24136	37.6	AN38
	134	145	M190×3	16	180	24136RHAK30+ AH24136	34.9	AN38
	105	110	M200×3	17	180	22236RK+ AH2236	33.5	AN40
	105	110	M200×3	17	180	22236RHAK+ AH2236	31.5	AN40
	140	146	M200×3	24	180	23236RRK+ AH3236	45.1	AN40
	140	146	M200×3	24	180	23236RHAK+ AH3236	41.8	AN40
	154	160	M200×3	24	180	22336RK+ AH2336	75.7	AN40
	154	160	M200×3	24	180	22336RHAK+ AH2336	70.3	AN40

[Note] 1) Basic profile and dimensions of screw thread identified by prefix M are in accordance with JIS B 0205.
Basic profile and dimensions of screw thread identified by prefix Tr are in accordance with JIS B 0216.

Withdrawal sleeves for spherical roller bearings

d_1 180 ~ 190 mm

d_1 200 ~ 220 mm

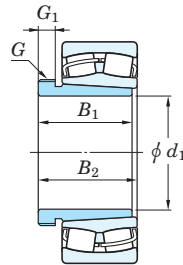

d_1	Boundary dimensions (mm)			G_1	Brg. bore d (mm)	Designations Bearing + withdrawal sleeve	Mass Brg.+withdrawal sleeve (kg)	(Refer.) Applicable locknut No.	
	B_1	B_2	$G^{1)}$ Screw size						
180	96	102	Tr205×4	18	190	23038RK+AH3038	21.5	HNL41	
	96	102	Tr205×4	18	190	23038RHAK+AH3038	19.9	HNL41	
	118	131	M200×3	18	190	24038RRK30+AH24038	27.6	AN40	
	118	131	M200×3	18	190	24038RHAK30+AH24038	25.5	AN40	
	125	131	Tr210×4	20	190	23138RK+AH3138	39.3	HN42	
	125	131	Tr210×4	20	190	23138RHAK+AH3138	37.0	HN42	
	146	159	M200×3	18	190	24138RRK30+AH24138	46.7	AN40	
	146	159	M200×3	18	190	24138RHAK30+AH24138	43.8	AN40	
	112	117	Tr210×4	18	190	22238RK+AH2238	40.9	HN42	
	112	117	Tr210×4	18	190	22238RHAK+AH2238	38.4	HN42	
	145	152	Tr210×4	25	190	23238RRK+AH3238	53.3	HN42	
	145	152	Tr210×4	25	190	23238RHAK+AH3238	49.4	HN42	
	160	167	Tr210×4	26	190	22338RK+AH2338	89.0	HN42	
	160	167	Tr210×4	26	190	22338RHAK+AH2338	82.6	HN42	
	190	102	108	Tr215×4	19	200	23040RK+AH3040	27.2	HNL43
		102	108	Tr215×4	19	200	23040RHAK+AH3040	25.1	HNL43
127		140	Tr210×4	18	200	24040RRK30+AH24040	34.6	HN42	
127		140	Tr210×4	18	200	24040RHAK30+AH24040	31.9	HN42	
134		140	Tr220×4	21	200	23140RRK+AH3140	47.9	HN44	
134		140	Tr220×4	21	200	23140RHAK+AH3140	45.0	HN44	
158		171	Tr210×4	18	200	24140RRK30+AH24140	57.6	HN42	
158		171	Tr210×4	18	200	24140RHAK30+AH24140	53.8	HN42	
118		123	Tr220×4	19	200	22240RRK+AH2240	48.7	HN44	
118		123	Tr220×4	19	200	22240RHAK+AH2240	45.7	HN44	
153		160	Tr220×4	25	200	23240RK+AH3240	64.7	HN44	
153		160	Tr220×4	25	200	23240RHAK+AH3240	60.1	HN44	
170		177	Tr220×4	26	200	22340RK+AH2340	101	HN44	
170		177	Tr220×4	26	200	22340RHAK+AH2340	93.4	HN44	

d_1	Boundary dimensions (mm)			G_1	Brg. bore d (mm)	Designations Bearing + withdrawal sleeve	Mass Brg.+withdrawal sleeve (kg)	(Refer.) Applicable locknut No.	
	B_1	B_2	$G^{1)}$ Screw size						
200	111	117	Tr235×4	20	220	23044RK+AH3044	38.0	HNL47	
	111	117	Tr235×4	20	220	23044RHAK+AH3044	35.3	HNL47	
	138	152	Tr230×4	20	220	24044RRK30+AH24044	48.1	—	
	138	152	Tr230×4	20	220	24044RHAK30+AH24044	44.7	—	
	145	151	Tr240×4	23	220	23144RK+AH3144	63.6	HN48	
	145	151	Tr240×4	23	220	23144RHAK+AH3144	60.0	HN48	
	170	184	Tr230×4	20	220	24144RRK30+AH24144	76.4	—	
	170	184	Tr230×4	20	220	24144RHAK30+AH24144	71.2	—	
	130	136	Tr240×4	20	220	22244RRK+AH2244	70.8	HN48	
	130	136	Tr240×4	20	220	22244RHAK+AH2244	66.6	HN48	
	181	189	Tr240×4	30	220	23244RK+AH2344	95.1	HN48	
	181	189	Tr240×4	30	220	23244RHAK+AH2344	88.5	HN48	
	181	189	Tr240×4	30	220	22344RK+AH2344	136	HN48	
	181	189	Tr240×4	30	220	22344RHAK+AH2344	127	HN48	
	220	116	123	Tr260×4	21	240	23048RRK+AH3048	42.6	HNL52
		116	123	Tr260×4	21	240	23048RHAK+AH3048	39.7	HNL52
138		153	Tr250×4	20	240	24048RRK30+AH24048	51.9	—	
138		153	Tr250×4	20	240	24048RHAK30+AH24048	48.0	—	
154		161	Tr260×4	25	240	23148RRK+AH3148	77.6	HN52	
154		161	Tr260×4	25	240	23148RHAK+AH3148	73.1	HN52	
180		195	Tr260×4	20	240	24148RRK30+AH24148	94.0	HN52	
180		195	Tr260×4	20	240	24148RHAK30+AH24148	87.9	HN52	
144		150	Tr260×4	21	240	22248RK+AH2248	94.3	HN52	
144		150	Tr260×4	21	240	22248RHAK+AH2248	88.7	HN52	
189		197	Tr260×4	30	240	23248RRK+AH2348	126	HN52	
189		197	Tr260×4	30	240	23248RHAK+AH2348	117	HN52	
189		197	Tr260×4	30	240	22348RK+AH2348	170	HN52	
189		197	Tr260×4	30	240	22348RHAK+AH2348	158	HN52	

[Note] 1) Basic profile and dimensions of screw thread identified by prefix M are in accordance with JIS B 0205.
Basic profile and dimensions of screw thread identified by prefix Tr are in accordance with JIS B 0216.

Withdrawal sleeves for spherical roller bearings

d_1 240 ~ 260 mm

d_1 280 ~ (320) mm

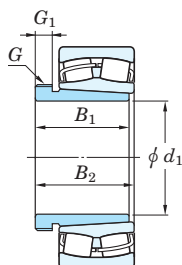

d_1	Boundary dimensions (mm)			G_1	Brg. bore d (mm)	Designations Bearing + withdrawal sleeve	Mass Brg.+withdrawal sleeve (kg)	(Refer.) Applicable locknut No.
	B_1	B_2	$G^{(1)}$ Screw size					
240	128	135	Tr280×4	23	260	23052RK+AH3052	60.0	HNL56
	128	135	Tr280×4	23	260	23052RHAK+AH3052	55.6	HNL56
	162	178	Tr270×4	22	260	24052RRK30+AH24052	77.0	—
	162	178	Tr270×4	22	260	24052RHAK30+AH24052	71.2	—
	172	179	Tr290×4	26	260	23152RK+AH3152	107	HN58
	172	179	Tr290×4	26	260	23152RHAK+AH3152	101	HN58
	202	218	Tr280×4	22	260	24152RRK30+AH24152	128	—
	202	218	Tr280×4	22	260	24152RHAK30+AH24152	120	—
	155	161	Tr290×4	23	260	22252RK+AH2252	122	HN58
	155	161	Tr290×4	23	260	22252RHAK+AH2252	115	HN58
	205	213	Tr290×4	30	260	23252RK+AH2352	164	HN58
	205	213	Tr290×4	30	260	23252RHAK+AH2352	153	HN58
	205	213	Tr290×4	30	260	22352RK+AH2352	212	HN58
	205	213	Tr290×4	30	260	22352RHAK+AH2352	197	HN58
260	131	139	Tr300×4	24	280	23056RK+AH3056	64.9	HNL60
	131	139	Tr300×4	24	280	23056RHAK+AH3056	60.2	HNL60
	162	179	Tr290×4	22	280	24056RRK30+AH24056	81.9	HN58
	162	179	Tr290×4	22	280	24056RHAK30+AH24056	75.7	HN58
	175	183	Tr310×5	28	280	23156RRK+AH3156	114	HN62
	175	183	Tr310×5	28	280	23156RHAK+AH3156	108	HN62
	202	219	Tr300×4	22	280	24156RRK30+AH24156	136	—
	202	219	Tr300×4	22	280	24156RHAK30+AH24156	128	—
	155	163	Tr310×5	24	280	22256RK+AH2256	127	HN62
	155	163	Tr310×5	24	280	22256RHAK+AH2256	119	HN62
	212	220	Tr310×5	30	280	23256RK+AH2356	175	HN62
	212	220	Tr310×5	30	280	23256RHAK+AH2356	163	HN62
	212	220	Tr310×5	30	280	22356RK+AH2356	247	HN62
	212	220	Tr310×5	30	280	22356RHAK+AH2356	230	HN62

d_1	Boundary dimensions (mm)			G_1	Brg. bore d (mm)	Designations Bearing + withdrawal sleeve	Mass Brg.+withdrawal sleeve (kg)	(Refer.) Applicable locknut No.
	B_1	B_2	$G^{(1)}$ Screw size					
280	145	153	Tr320×5	26	300	23060RK+AH3060	88.1	HNL64
	145	153	Tr320×5	26	300	23060RHAK+AH3060	81.2	HNL64
	184	202	Tr310×5	24	300	24060RRK30+AH24060	112	HN62
	184	202	Tr310×5	24	300	24060RHAK30+AH24060	105	HN62
	192	200	Tr330×5	30	300	23160RRK+AH3160	149	HN66
	192	200	Tr330×5	30	300	23160RHAK+AH3160	140	HN66
	224	242	Tr320×5	24	300	24160RRK30+AH24160	180	—
	224	242	Tr320×5	24	300	24160RHAK30+AH24160	168	—
	170	178	Tr330×5	26	300	22260RK+AH2260	160	HN66
	170	178	Tr330×5	26	300	22260RHAK+AH2260	150	HN66
300	228	236	Tr330×5	34	300	23260RK+AH3260	223	HN66
	228	236	Tr330×5	34	300	23260RHAK+AH3260	208	HN66
	149	157	Tr345×5	27	320	23064RK+AH3064	94.8	HNL69
	149	157	Tr345×5	27	320	23064RHAK+AH3064	88.1	HNL69
	184	202	Tr330×5	24	320	24064RRK30+AH24064	120	HN66
	184	202	Tr330×5	24	320	24064RHAK30+AH24064	108	HN66
	209	217	Tr350×5	31	320	23164RK+AH3164	191	HN70
	209	217	Tr350×5	31	320	23164RHAK+AH3164	180	HN70
	242	260	Tr340×5	24	320	24164RRK30+AH24164	226	—
	242	260	Tr340×5	24	320	24164RHAK30+AH24164	217	—
320	180	190	Tr350×5	27	320	22264RK+AH2264	191	HN70
	246	254	Tr350×5	36	320	23264RK+AH3264	280	HN70
	246	254	Tr350×5	36	320	23264RHAK+AH3264	260	HN70
	162	171	Tr365×5	28	340	23068RK+AH3068	125	HNL73
	162	171	Tr365×5	28	340	23068RHAK+AH3068	115	HNL73
	225	234	Tr370×5	33	340	23168RK+AH3168	239	HN74
	225	234	Tr370×5	33	340	23168RHAK+AH3168	225	HN74
	269	288	Tr360×5	26	340	24168RRK30+AH24168	293	—

[Note] 1) Basic profile and dimensions of screw thread identified by prefix M are in accordance with JIS B 0205.
Basic profile and dimensions of screw thread identified by prefix Tr are in accordance with JIS B 0216.

Withdrawal sleeves for spherical roller bearings

d_1 (320) ~ 380 mm

d_1 400 ~ 480 mm

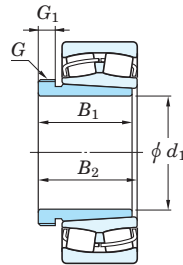

d_1	Boundary dimensions (mm)			G_1	Brg. bore d (mm)	Designations Bearing + withdrawal sleeve	Mass Brg.+withdrawal sleeve (kg)	(Refer.) Applicable locknut No.
	B_1	B_2	$G^{1)}$ Screw size					
320	269	288	Tr360×5	26	340	24168RHAK30+ AH24168	282	—
	264	273	Tr370×5	38	340	23268RK+ AH3268	342	HN74
	264	273	Tr370×5	38	340	23268RHAK+ AH3268	317	HN74
340	167	176	Tr385×5	30	360	23072RK+ AH3072	132	HNL77
	167	176	Tr385×5	30	360	23072RHAK+ AH3072	122	HNL77
	229	238	Tr400×5	35	360	23172RK+ AH3172	254	HN80
	232	238	Tr400×5	35	360	23172RHAK+ AH3172	239	HN80
	269	289	Tr380×5	26	360	24172RK30+ AH24172	313	—
	269	289	Tr380×5	26	360	24172RHAK30+ AH24172	300	—
	274	283	Tr400×5	40	360	23272RK+ AH3272	388	HN80
	274	283	Tr400×5	40	360	23272RHAK+ AH3272	360	HN80
360	170	180	Tr410×5	31	380	23076RK+ AH3076	141	HNL82
	170	180	Tr410×5	31	380	23076RHAK+ AH3076	131	HNL82
	232	242	Tr420×5	36	380	23176RK+ AH3176	269	HN84
	240	242	Tr420×5	36	380	23176RHAK+ AH3176	253	HN84
	271	291	Tr400×5	28	380	24176RK30+ AH24176	328	HN80
	271	291	Tr400×5	28	380	24176RHAK30+ AH24176	314	HN80
	284	294	Tr420×5	42	380	23276RK+ AH3276	432	HN84
	284	294	Tr420×5	42	380	23276RHAK+ AH3276	400	HN84
380	183	193	Tr430×5	33	400	23080RK+ AH3080	178	HNL86
	183	193	Tr430×5	33	400	23080RHAK+ AH3080	165	HNL86
	240	250	Tr440×5	38	400	23180RK+ AH3180	305	HN88
	266	250	Tr440×5	38	400	23180RHAK+ AH3180	287	HN88
	278	298	Tr420×5	28	400	24180RK30+ AH24180	368	HN84
	278	298	Tr420×5	28	400	24180RHAK30+ AH24180	352	HN84
	302	312	Tr440×5	44	400	23280RK+ AH3280	521	HN88
	302	312	Tr440×5	44	400	23280RHAK+ AH3280	480	HN88

d_1	Boundary dimensions (mm)			G_1	Brg. bore d (mm)	Designations Bearing + withdrawal sleeve	Mass Brg.+withdrawal sleeve (kg)	(Refer.) Applicable locknut No.
	B_1	B_2	$G^{1)}$ Screw size					
400	186	196	Tr450×5	34	420	23084RK+ AH3084	188	HNL90
	186	196	Tr450×5	34	420	23084RHAK+ AH3084	174	HNL90
	266	276	Tr460×5	40	420	23184RK+ AH3184	399	HN92
	270	276	Tr460×5	40	420	23184RHAK+ AH3184	375	HN92
	321	331	Tr460×5	46	420	23284RK+ AH3284	673	HN92
420	321	331	Tr460×5	46	420	23284RHAK+ AH3284	568	HN92
	194	205	Tr470×5	35	440	23088RK+ AHX3088	215	HNL94
	194	205	Tr470×5	35	440	23088RHAK+ AHX3088	199	HNL94
	270	281	Tr480×5	42	440	23188RK+ AHX3188	416	HN96
	285	281	Tr480×5	42	440	23188RHAK+ AHX3188	391	HN96
440	330	341	Tr480×5	48	440	23288RK+ AHX3288	678	HN96
	330	341	Tr480×5	48	440	23288RHAK+ AHX3288	627	HN96
	202	213	Tr490×5	37	460	23092RK+ AHX3092	244	HNL98
	202	213	Tr490×5	37	460	23092RHAK+ AHX3092	226	HNL98
	285	296	Tr510×6	43	460	23192RK+ AHX3192	494	HN102
460	295	296	Tr510×6	43	460	23192RHAK+ AHX3192	464	HN102
	349	360	Tr510×6	50	460	23292RK+ AHX3292	795	HN102
	349	360	Tr510×6	50	460	23292RHAK+ AHX3292	733	HN102
	205	217	Tr520×6	38	480	23096RK+ AHX3096	257	HNL104
	205	217	Tr520×6	38	480	23096RHAK+ AHX3096	238	HNL104
480	295	307	Tr530×6	45	480	23196RK+ AHX3196	551	HN106
	313	307	Tr530×6	45	480	23196RHAK+ AHX3196	518	HN106
	364	376	Tr530×6	52	480	23296RK+ AHX3296	914	HN106
	364	376	Tr530×6	52	480	23296RHAK+ AHX3296	844	HN106
	209	221	Tr540×6	40	500	230/500RK+ AHX30/500	271	HNL108
500	313	325	Tr550×6	47	500	231/500RK+ AHX31/500	648	HN110
	393	405	Tr550×6	54	500	232/500RK+ AHX32/500	1 015	HN110

[Note] 1) Basic profile and dimensions of screw thread identified by prefix M are in accordance with JIS B 0205.
Basic profile and dimensions of screw thread identified by prefix Tr are in accordance with JIS B 0216.

Thrust ball bearings

Thrust ball bearings are divided into single and double direction types. The former is able to accommodate axial load in one direction, while the latter is able to accommodate it in both directions.

Neither is suitable for applications that involve radial load or high-speed rotation.

Bearings whose housing race back face is spherical (with a spherical back face or aligning seat race) are designed with a self-aligning capability and can accommodate the effects of inaccurate mounting.

Single direction thrust ball bearings

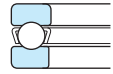

Bore diameter 10 – 360 mm

Double direction thrust ball bearings

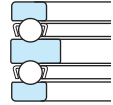

Bore diameter 10 – 190 mm



Boundary dimensions	As specified in JIS B 1512.
Tolerances	As specified in JIS B 1514-2. (refer to Table 7-9 on p. A 74.)
Recommended fits	Refer to Table 9-8 on p. A 98.
Standard cages	<ul style="list-style-type: none"> • Pressed cage (supplementary code : //) • Copper alloy or carbon steel machined cage (supplementary code : FY or FC) • Polyamide resin molded cage (supplementary code : MG)

Application of standard cages

Bearing series	Molded cage	Pressed cage	Machined cage
511	51100 – 51107	51108 – 51132	51134 – 51172
512	51200 – 51207	51208 – 51224	51226 – 51272
532	53200 – 53207	53208 – 53224	53226 – 53272
532 U	53200U – 53207U	53208U – 53224U	53226U – 53272U
513	–	51305 – 51313	51314 – 51340
533	–	53305 – 53313	53314 – 53340
533 U	–	53305U – 53313U	53314U – 53340U
514	–	51405 – 51416	51417 – 51436
534	–	53405 – 53416	53417 – 53420
534 U	–	53405U – 53416U	53417U – 53420U
522	–	52202 – 52224	52226 – 52244
542	–	54202 – 54224	54226 – 54244
542 U	–	54205U – 54224U	54226U – 54244U
523	–	52305 – 52313	52314 – 52340
543	–	54305 – 54313	54314 – 54324
543 U	–	54305U – 54313U	54314U – 54324U
524	–	52405 – 52411	52412 – 52444
544	–	54405 – 54411	54412 – 54420
544 U	–	54405U – 54411U	54412U – 54420U

Required minimum axial load	A certain degree of load is necessary in order for bearings to operate satisfactorily. (refer to p. A 116.)
Allowable misalignment	Misalignment not allowed. (for flat back face type.)
Equivalent axial load	Dynamic equivalent axial load $P_a = F_a$ Static equivalent axial load $P_{0a} = F_a$

Single direction thrust ball bearings

d 10 ~ (40) mm

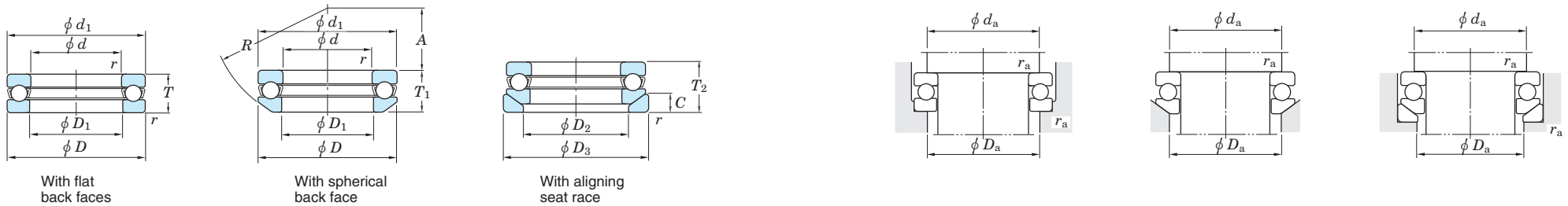

Boundary dimensions (mm)						Basic load ratings (kN)		Fatigue load limit (kN)	Limiting speeds (min ⁻¹)		Bearing No.			Dimensions (mm)						Mounting dimensions (mm)			(Refer.) Mass (kg)			
d	D	T	T ₁	T ₂	r _{min.}	C _a	C _{0a}	C _u	Grease lub.	Oil lub.	With flat back faces	With spherical back face	With aligning seat race	d ₁ max.	D ₁ min.	D ₂	D ₃	A	R	C	d _a min.	D _a max.	r _a max.	With flat back faces	With spherical back face	With aligning seat race
10	24	9	—	—	0.3	12.5	14.0	0.630	6 500	10 000	51100	—	—	24	11	—	—	—	—	—	18	16	0.3	0.020	—	—
	26	11	11.6	13	0.6	15.8	17.1	0.770	5 700	8 800	51200	53200	53200U	26	12	18	28	8.5	22	3.5	20	16	0.6	0.030	0.029	0.037
12	26	9	—	—	0.3	12.9	14.0	0.690	6 500	10 000	51101	—	—	26	13	—	—	—	—	—	20	18	0.3	0.022	—	—
	28	11	11.4	13	0.6	16.5	19.0	0.860	5 400	8 300	51201	53201	53201U	28	14	20	30	11.5	25	3.5	22	18	0.6	0.034	0.031	0.043
15	28	9	—	—	0.3	13.2	15.4	0.760	6 100	9 400	51102	—	—	28	16	—	—	—	—	—	23	20	0.3	0.024	—	—
	32	12	13.3	15	0.6	20.8	24.8	1.10	4 900	7 500	51202	53202	53202U	32	17	24	35	12	28	4	25	22	0.6	0.046	0.048	0.062
17	30	9	—	—	0.3	13.5	18.2	0.820	6 100	9 400	51103	—	—	30	18	—	—	—	—	—	25	22	0.3	0.028	—	—
	35	12	13.2	15	0.6	21.5	27.3	1.25	4 900	7 500	51203	53203	53203U	35	19	26	38	16	32	4	28	24	0.6	0.053	0.055	0.070
20	35	10	—	—	0.3	17.8	24.7	1.10	5 100	7 900	51104	—	—	35	21	—	—	—	—	—	29	26	0.3	0.040	—	—
	40	14	14.7	17	0.6	27.9	37.7	1.70	3 900	6 000	51204	53204	53204U	40	22	30	42	18	36	5	32	28	0.6	0.082	0.080	0.100
25	42	11	—	—	0.6	24.4	37.2	1.70	4 400	6 800	51105	—	—	42	26	—	—	—	—	—	35	32	0.6	0.059	—	—
	47	15	16.7	19	0.6	34.6	50.4	2.30	3 600	5 500	51205	53205	53205U	47	27	36	50	19	40	5.5	38	34	0.6	0.120	0.120	0.152
	52	18	19.8	22	1	44.7	61.4	2.75	3 100	4 800	51305	53305	53305U	52	27	38	55	21	45	6	41	36	1	0.180	0.180	0.224
	60	24	26.4	29	1	69.5	89.4	4.05	2 600	4 000	51405	53405	53405U	60	27	42	62	19	50	8	46	39	1	0.340	0.350	0.442
30	47	11	—	—	0.6	25.5	42.2	1.90	4 300	6 600	51106	—	—	47	32	—	—	—	—	—	40	37	0.6	0.068	—	—
	52	16	17.8	20	0.6	36.7	58.2	2.65	3 400	5 200	51206	53206	53206U	52	32	42	55	22	45	5.5	43	39	0.6	0.150	0.160	0.193
	60	21	22.6	25	1	53.5	78.7	3.55	2 700	4 200	51306	53306	53306U	60	32	45	62	22	50	7	48	42	1	0.270	0.270	0.326
	70	28	30.1	33	1	91.0	126	5.70	2 200	3 400	51406	53406	53406U	70	32	50	75	20	56	9	54	46	1	0.530	0.530	0.660
35	52	12	—	—	0.6	25.5	47.2	2.00	3 900	6 000	51107	—	—	52	37	—	—	—	—	—	45	42	0.6	0.090	—	—
	62	18	19.9	22	1	48.9	78.2	3.55	2 900	4 500	51207	53207	53207U	62	37	48	65	24	50	7	51	46	1	0.220	0.220	0.277
	68	24	25.6	28	1	69.3	105	4.75	2 400	3 700	51307	53307	53307U	68	37	52	72	24	56	7.5	55	48	1	0.390	0.400	0.484
	80	32	34	37	1.1	109	155	7.00	1 900	2 900	51407	53407	53407U	80	37	58	85	23	64	10	62	53	1	0.790	0.790	0.960
40	60	13	—	—	0.6	33.6	62.8	2.85	3 400	5 300	51108	—	—	60	42	—	—	—	—	—	52	48	0.6	0.120	—	—
	68	19	20.3	23	1	58.7	98.3	4.45	2 700	4 200	51208	53208	53208U	68	42	55	72	28.5	56	7	57	51	1	0.270	0.270	0.340
	78	26	28.5	31	1	86.6	135	6.05	2 100	3 300	51308	53308	53308U	78	42	60	82	28	64	8.5	63	55	1	0.550	0.570	0.690

[Remark] Standard cage types used for the above bearings are described earlier in this section.

Single direction thrust ball bearings

d (40) ~ 70 mm

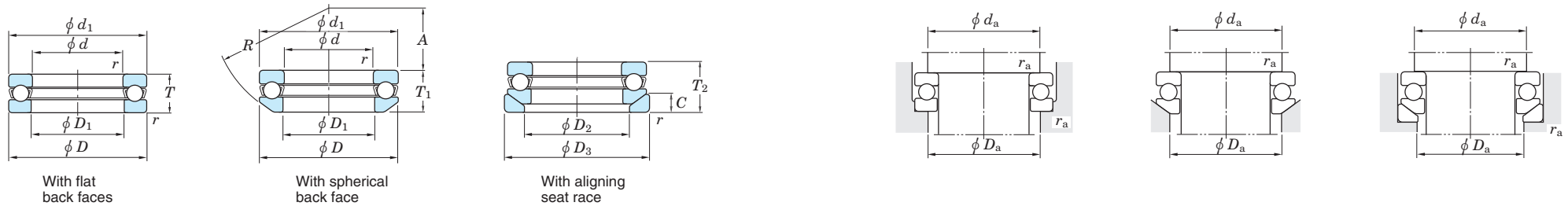

Boundary dimensions (mm)						Basic load ratings (kN)		Fatigue load limit (kN)	Limiting speeds (min ⁻¹)		Bearing No.			Dimensions (mm)						Mounting dimensions (mm)			(Refer.) Mass (kg)				
d	D	T	T ₁	T ₂	r _{min.}	C _a	C _{0a}	C _u	Grease lub.	Oil lub.	With flat back faces	With spherical back face	With aligning seat race	d ₁ max.	D ₁ min.	D ₂	D ₃	A	R	C	d _a min.	D _a max.	r _a max.	With flat back faces	With spherical back face	With aligning seat race	
40	90	36	38.2	42	1.1	141	205	9.25	1 700	2 600	51408	53408	53408U	90	42	65	95	26	72	12	70	60	1	1.14	1.12	1.37	
	45	65	14	—	—	0.6	34.8	69.1	3.10	3 200	5 000	51109	—	—	65	47	—	—	—	—	—	57	53	0.6	0.150	—	—
		73	20	21.3	24	1	59.7	105	4.75	2 600	4 000	51209	53209	53209U	73	47	60	78	26	56	7.5	62	56	1	0.320	0.310	0.397
		85	28	30.1	33	1	100	163	7.40	1 900	3 000	51309	53309	53309U	85	47	65	90	25	64	10	69	61	1	0.690	0.680	0.850
100	39	42.4	46	1.1	162	242	10.9	1 500	2 300	51409	53409	53409U	100	47	72	105	29	80	12.5	78	67	1	1.47	1.50	1.82		
50	70	14	—	—	0.6	35.9	75.4	3.40	3 100	4 800	51110	—	—	70	52	—	—	—	—	—	62	58	0.6	0.160	—	—	
	78	22	23.5	26	1	60.6	111	5.05	2 300	3 600	51210	53210	53210U	78	52	62	82	32.5	64	7.5	67	61	1	0.390	0.380	0.480	
	95	31	34.3	37	1.1	121	202	9.10	1 800	2 700	51310	53310	53310U	95	52	72	100	28	72	11	77	68	1	1.00	1.01	1.24	
	110	43	45.6	50	1.5	185	283	12.8	1 400	2 100	51410	53410	53410U	110	52	80	115	35	90	14	86	74	1.5	1.99	1.97	2.38	
55	78	16	—	—	0.6	43.5	93.1	4.20	2 800	4 300	51111	—	—	78	57	—	—	—	—	—	69	64	0.6	0.240	—	—	
	90	25	27.3	30	1	86.7	159	7.20	2 100	3 200	51211	53211	53211U	90	57	72	95	35	72	9	76	69	1	0.610	0.620	0.770	
	105	35	39.3	42	1.1	149	246	11.1	1 600	2 400	51311	53311	53311U	105	57	80	110	30	80	11.5	85	75	1	1.34	1.41	1.69	
	120	48	50.5	55	1.5	223	359	16.2	1 200	1 900	51411	53411	53411U	120	57	88	125	28	90	15.5	94	81	1.5	2.64	2.57	3.10	
60	85	17	—	—	1	51.8	113	5.10	2 600	4 000	51112	—	—	85	62	—	—	—	—	—	75	70	1	0.290	—	—	
	95	26	28	31	1	92.0	179	8.05	1 900	3 000	51212	53212	53212U	95	62	78	100	32.5	72	9	81	74	1	0.690	0.690	0.850	
	110	35	38.3	42	1.1	154	267	12.1	1 500	2 300	51312	53312	53312U	110	62	85	115	41	90	11.5	90	80	1	1.43	1.47	1.78	
	130	51	54	58	1.5	267	437	19.7	1 100	1 700	51412	53412	53412U	130	62	95	135	34	100	16	102	88	1.5	3.51	3.44	4.13	
65	90	18	—	—	1	52.1	117	5.30	2 400	3 700	51113	—	—	90	67	—	—	—	—	—	80	75	1	0.340	—	—	
	100	27	28.7	32	1	93.6	189	8.50	1 900	2 900	51213	53213	53213U	100	67	82	105	40	80	9	86	79	1	0.770	0.750	0.930	
	115	36	39.4	43	1.1	159	287	13.0	1 400	2 200	51313	53313	53313U	115	67	90	120	38.5	90	12.5	95	85	1	1.57	1.61	1.95	
	140	56	60.2	65	2	290	493	22.0	1 000	1 600	51413	53413	53413U	140	68	100	145	40	112	17.5	110	95	2	4.47	4.47	5.28	
70	95	18	—	—	1	53.8	127	5.70	2 300	3 600	51114	—	—	95	72	—	—	—	—	—	85	80	1	0.360	—	—	
	105	27	28.8	32	1	95.2	199	8.95	1 800	2 800	51214	53214	53214U	105	72	88	110	38	80	9	91	84	1	0.810	0.800	0.990	
	125	40	44.2	48	1.1	167	291	13.1	1 300	2 000	51314	53314	53314U	125	72	98	130	43	100	13	103	92	1	2.06	2.15	2.56	
	150	60	63.6	69	2	312	553	23.8	940	1 450	51414	53414	53414U	150	73	110	155	34	112	19.5	118	102	2	5.48	5.38	6.37	

[Remark] Standard cage types used for the above bearings are described earlier in this section.

Single direction thrust ball bearings

d 75 ~ (120) mm

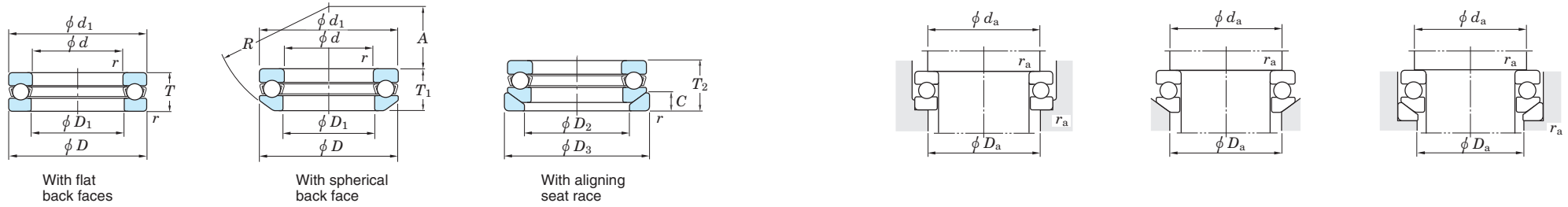

Boundary dimensions (mm)						Basic load ratings (kN)		Fatigue load limit (kN)	Limiting speeds (min ⁻¹)		Bearing No.			Dimensions (mm)						Mounting dimensions (mm)			(Refer.) Mass (kg)			
d	D	T	T ₁	T ₂	r _{min.}	C _a	C _{0a}	C _u	Grease lub.	Oil lub.	With flat back faces	With spherical back face	With aligning seat race	d ₁ max.	D ₁ min.	D ₂	D ₃	A	R	C	d _a min.	D _a max.	r _a max.	With flat back faces	With spherical back face	With aligning seat race
75	100	19	—	—	1	55.5	136	6.15	2 200	3 400	51115	—	—	100	77	—	—	—	—	—	90	85	1	0.420	—	—
	110	27	28.3	32	1	96.7	209	9.40	1 800	2 700	51215	53215	53215U	110	77	92	115	49	90	9.5	96	89	1	0.860	0.850	1.06
	135	44	48.1	52	1.5	192	339	15.0	1 200	1 900	51315	53315	53315U	135	77	105	140	37	100	15	111	99	1.5	2.68	2.72	3.27
	160	65	69	75	2	315	560	23.3	880	1 350	51415	53415	53415U	160	78	115	165	42	125	21	125	110	2	6.75	6.64	7.87
80	105	19	—	—	1	55.8	141	6.35	2 100	3 300	51116	—	—	105	82	—	—	—	—	—	95	90	1	0.430	—	—
	115	28	29.5	33	1	98.1	218	9.85	1 700	2 600	51216	53216	53216U	115	82	98	120	46	90	10	101	94	1	0.950	0.930	1.15
	140	44	47.6	52	1.5	200	368	15.8	1 200	1 800	51316	53316	53316U	140	82	110	145	50	112	15	116	104	1.5	2.82	2.86	3.43
	170	68	72.2	78	2.1	337	621	25.1	810	1 250	51416	53416	53416U	170	83	125	175	36	125	22	133	117	2	7.97	7.84	9.22
85	110	19	—	—	1	57.4	150	6.80	2 100	3 200	51117	—	—	110	87	—	—	—	—	—	100	95	1	0.460	—	—
	125	31	33.1	37	1	119	264	11.6	1 500	2 300	51217	53217	53217U	125	88	105	130	52	100	11	109	101	1	1.29	1.28	1.57
	150	49	53.1	58	1.5	232	419	17.5	1 100	1 700	51317	53317	53317U	150	88	115	155	43	112	17.5	124	111	1.5	3.66	3.63	4.44
	180	72	77	83	2.1	384	753	29.5	780	1 200	51417	53417	53417U	177	88	130	185	47	140	23	141	124	2	9.29	9.20	10.8
90	120	22	—	—	1	74.6	190	8.40	1 900	2 900	51118	—	—	120	92	—	—	—	—	—	108	102	1	0.680	—	—
	135	35	38.5	42	1.1	146	326	13.9	1 400	2 100	51218	53218	53218U	135	93	110	140	45	100	13.5	117	108	1	1.77	1.77	2.19
	155	50	54.6	59	1.5	242	454	18.5	1 000	1 600	51318	53318	53318U	155	93	120	160	40	112	18	129	116	1.5	3.88	3.87	4.71
	190	77	81.2	88	2.1	409	826	31.5	710	1 100	51418	53418	53418U	187	93	140	195	40	140	25.5	149	131	2	11.0	10.7	12.6
100	135	25	—	—	1	106	268	11.2	1 600	2 500	51120	—	—	135	102	—	—	—	—	—	121	114	1	0.990	—	—
	150	38	40.9	45	1.1	183	410	16.6	1 200	1 900	51220	53220	53220U	150	103	125	155	52	112	14	130	120	1	2.36	2.34	2.84
	170	55	59.2	64	1.5	296	595	23.2	940	1 450	51320	53320	53320U	170	103	135	175	46	125	18	142	128	1.5	5.11	5.10	6.05
	210	85	90	98	3	460	983	35.7	620	950	51420	53420	53420U	205	103	155	220	50	160	27	165	145	2.5	14.6	14.5	17.4
110	145	25	—	—	1	109	288	11.5	1 600	2 400	51122	—	—	145	112	—	—	—	—	—	131	124	1	1.08	—	—
	160	38	40.2	45	1.1	191	450	17.6	1 200	1 800	51222	53222	53222U	160	113	135	165	65	125	14	140	130	1	2.57	2.50	3.06
	190	63	67.2	72	2	334	704	25.9	810	1 250	51322	53322	53322U	187	113	150	195	51	140	20.5	158	142	2	7.72	7.63	8.90
	230	95	—	—	3	474	1 070	37.1	550	850	51422	—	—	225	113	—	—	—	—	—	181	159	2.5	19.8	—	—
120	155	25	—	—	1	111	305	11.9	1 500	2 300	51124	—	—	155	122	—	—	—	—	—	141	134	1	1.16	—	—

[Remark] Standard cage types used for the above bearings are described earlier in this section.

Single direction thrust ball bearings

d (120) ~ (180) mm

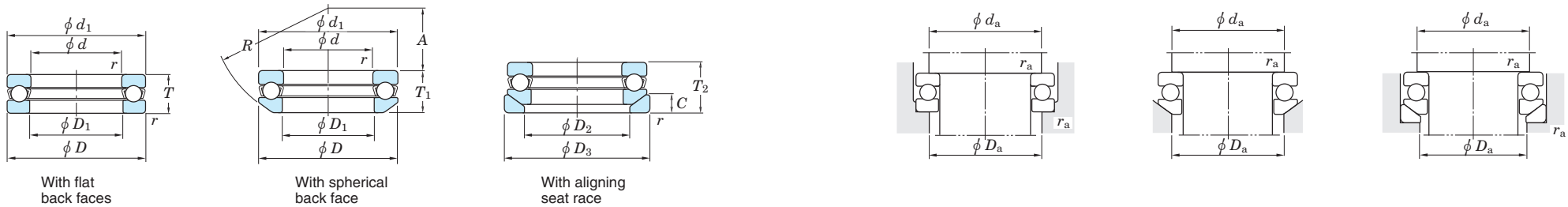

Boundary dimensions (mm)						Basic load ratings (kN)		Fatigue load limit (kN)	Limiting speeds (min ⁻¹)		Bearing No.			Dimensions (mm)						Mounting dimensions (mm)			(Refer.) Mass (kg)			
d	D	T	T ₁	T ₂	r _{min.}	C _a	C _{0a}	C _u	Grease lub.	Oil lub.	With flat back faces	With spherical back face	With aligning seat race	d ₁ max.	D ₁ min.	D ₂	D ₃	A	R	C	d _a min.	D _a max.	r _a max.	With flat back faces	With spherical back face	With aligning seat race
120	170	39	40.8	46	1.1	192	470	17.7	1 100	1 700	51224	53224	53224U	170	123	145	175	61	125	15	150	140	1	2.86	2.81	3.46
	210	70	74.1	80	2.1	389	869	30.5	710	1 100	51324	53324	53324U	205	123	165	220	63	160	22	173	157	2	10.6	10.4	12.4
	250	102	—	—	4	601	1 460	48.5	520	800	51424	—	—	245	123	—	—	—	—	—	196	174	3	25.0	—	—
130	170	30	—	—	1	130	350	13.0	1 300	2 000	51126	—	—	170	132	—	—	—	—	—	154	146	1	1.87	—	—
	190	45	47.9	53	1.5	254	620	22.2	970	1 500	51226	53226	53226U	187	133	160	195	67	140	17	166	154	1.5	4.09	3.98	4.88
	225	75	80.3	86	2.1	413	958	32.5	650	1 000	51326	53326	53326U	220	134	177	235	53	160	26	186	169	2	13.0	12.7	15.2
	270	110	—	—	4	623	1 540	49.0	490	750	51426	—	—	265	134	—	—	—	—	—	212	188	3	31.4	—	—
140	180	31	—	—	1	133	375	13.5	1 200	1 900	51128	—	—	178	142	—	—	—	—	—	164	156	1	2.02	—	—
	200	46	48.6	55	1.5	234	650	19.6	940	1 450	51228	53228	53228U	197	143	170	210	87	160	17	176	164	1.5	4.46	4.35	5.89
	240	80	84.9	92	2.1	458	1 130	36.9	620	950	51328	53328	53328U	235	144	190	250	68	180	26	199	181	2	15.5	15.1	18.0
	280	112	—	—	4	650	1 680	52.2	450	700	51428	—	—	275	144	—	—	—	—	—	222	198	3	33.9	—	—
150	190	31	—	—	1	137	400	13.9	1 200	1 900	51130	—	—	188	152	—	—	—	—	—	174	166	1	2.15	—	—
	215	50	53.3	60	1.5	266	652	21.8	840	1 300	51230	53230	53230U	212	153	180	225	79	160	20.5	189	176	1.5	5.64	5.45	7.14
	250	80	83.7	92	2.1	451	1 130	36.0	580	900	51330	53330	53330U	245	154	200	260	89.5	200	26	209	191	2	16.3	15.7	18.8
	300	120	—	—	4	711	1 910	57.4	420	650	51430	—	—	295	154	—	—	—	—	—	238	212	3	41.6	—	—
160	200	31	—	—	1	140	425	14.4	1 200	1 800	51132	—	—	198	162	—	—	—	—	—	184	176	1	2.28	—	—
	225	51	54.7	61	1.5	279	718	23.4	810	1 250	51232	53232	53232U	222	163	190	235	74	160	21	199	186	1.5	6.53	6.09	7.90
	270	87	91.7	100	3	512	1 340	41.3	550	850	51332	53332	53332U	265	164	215	280	77	200	29	225	205	2.5	21.0	21.0	23.4
	320	130	—	—	5	852	2 410	70.3	390	600	51432	—	—	315	164	—	—	—	—	—	254	226	4	51.2	—	—
170	215	34	—	—	1.1	168	510	16.7	1 100	1 700	51134	—	—	213	172	—	—	—	—	—	197	188	1	3.25	—	—
	240	55	58.7	65	1.5	326	834	26.3	750	1 150	51234	53234	53234U	237	173	200	250	91	180	21.5	212	198	1.5	8.12	7.69	9.83
	280	87	91.3	100	3	579	1 570	47.4	520	800	51334	53334	53334U	275	174	220	290	105	225	29	235	215	2.5	22.0	22.0	24.5
	340	135	—	—	5	943	2 730	77.2	360	550	51434	—	—	335	174	—	—	—	—	—	270	240	4	60.0	—	—
180	225	34	—	—	1.1	168	525	16.7	1 000	1 600	51136	—	—	222	183	—	—	—	—	—	207	198	1	3.39	—	—
	250	56	58.2	66	1.5	332	874	26.9	710	1 100	51236	53236	53236U	247	183	210	260	112	200	21.5	222	208	1.5	8.68	8.08	10.4
	300	95	99.3	109	3	578	1 580	46.2	490	750	51336	53336	53336U	295	184	240	310	91	225	32	251	229	2.5	28.1	26.9	29.9

[Remark] Standard cage types used for the above bearings are described earlier in this section.

Single direction thrust ball bearings

d (180) ~ 360 mm

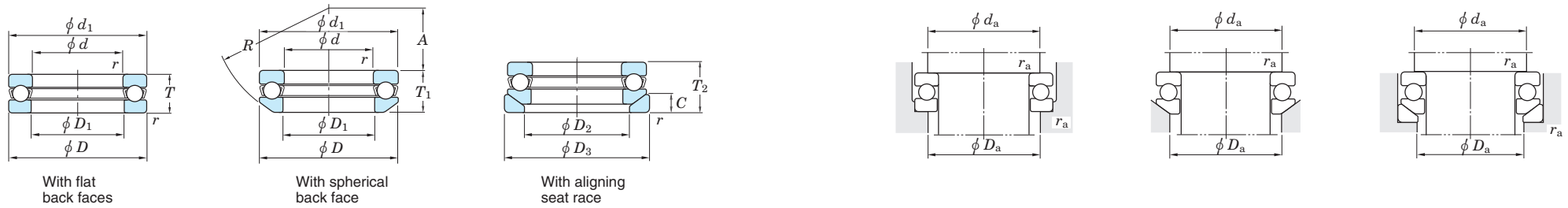

Boundary dimensions (mm)						Basic load ratings (kN)		Fatigue load limit (kN)	Limiting speeds (min ⁻¹)		Bearing No.			Dimensions (mm)						Mounting dimensions (mm)			(Refer.) Mass (kg)			
d	D	T	T_1	T_2	$r_{min.}$	C_a	C_{0a}	C_u	Grease lub.	Oil lub.	With flat back faces	With spherical back face	With aligning seat race	d_1 max.	D_1 min.	D_2	D_3	A	R	C	d_a min.	D_a max.	r_a max.	With flat back faces	With spherical back face	With aligning seat race
180	360	140	—	—	5	928	2 730	75.1	320	500	51436	—	—	355	184	—	—	—	—	—	286	254	4	69.5	—	—
190	240	37	—	—	1.1	213	655	20.2	970	1 500	51138	—	—	237	193	—	—	—	—	—	220	210	1	3.95	—	—
	270	62	65.7	73	2	385	1 060	31.4	650	1 000	51238	53238	53238U	267	194	230	280	98	200	23	238	222	2	11.7	11.2	13.9
	320	105	111	121	4	679	1 950	55.3	440	680	51338	53338	53338U	315	195	255	330	104	250	33	266	244	3	36.0	36.3	39.7
200	250	37	—	—	1.1	215	675	20.4	940	1 450	51140	—	—	247	203	—	—	—	—	—	230	220	1	4.13	—	—
	280	62	65.3	74	2	392	1 110	32.2	620	950	51240	53240	53240U	277	204	240	290	125	225	23	248	232	2	12.2	11.6	14.8
	340	110	118.4	130	4	745	2 220	61.1	420	650	51340	53340	53340U	335	205	270	350	92	250	38	282	258	3	42.9	42.7	46.7
220	270	37	—	—	1.1	221	740	21.3	880	1 350	51144	—	—	267	223	—	—	—	—	—	250	240	1	4.50	—	—
	300	63	65.6	75	2	428	1 310	36.6	580	900	51244	53244	53244U	297	224	260	310	118	225	25	268	252	2	13.5	12.6	15.9
240	300	45	—	—	1.5	301	1 020	28.0	750	1 150	51148	—	—	297	243	—	—	—	—	—	276	264	1.5	7.38	—	—
	340	78	81.6	92	2.1	553	1 800	47.8	520	800	51248	53248	53248U	335	244	290	350	122	250	30	299	281	2	23.1	20.9	25.6
260	320	45	—	—	1.5	289	990	26.2	710	1 100	51152	—	—	317	263	—	—	—	—	—	296	284	1.5	7.93	—	—
	360	79	82.8	93	2.1	556	1 880	48.1	490	750	51252	53252	53252U	355	264	305	370	152	280	30	319	301	2	25.0	22.6	28.5
280	350	53	—	—	1.5	411	1 430	36.4	640	900	51156	—	—	347	283	—	—	—	—	—	322	308	1.5	12.0	—	—
300	380	62	—	—	2	454	1 610	39.4	540	810	51160	—	—	376	304	—	—	—	—	—	348	332	2	17.5	—	—
	420	95	100.5	112	3	713	2 600	61.9	400	600	51260	53260	53260U	415	304	360	430	164	320	34	371	349	2.5	42.5	39.5	48.0
320	400	63	—	—	2	474	1 760	41.9	540	810	51164	—	—	396	324	—	—	—	—	—	368	352	2	19.0	—	—
	440	95	100.5	112	3	721	2 710	62.9	400	600	51264	53264	53264U	435	325	380	450	157	320	36	391	369	2.5	45.0	42.0	52.0
340	420	64	—	—	2	483	1 860	43.1	500	770	51168	—	—	416	344	—	—	—	—	—	388	372	2	20.5	—	—
	460	96	100.3	113	3	730	2 830	63.8	380	570	51268	53268	53268U	455	345	400	470	199	360	36	411	389	2.5	48.0	45.0	55.0
360	440	65	—	—	2	493	1 960	44.3	500	720	51172	—	—	436	364	—	—	—	—	—	408	392	2	21.5	—	—
	500	110	116.7	130	4	876	3 500	76.1	340	500	51272	53272	53272U	495	365	430	510	172	360	43	443	417	3	70.0	65.0	82.0

[Remark] Standard cage types used for the above bearings are described earlier in this section.

Double direction thrust ball bearings

d_2 10 ~ (50) mm

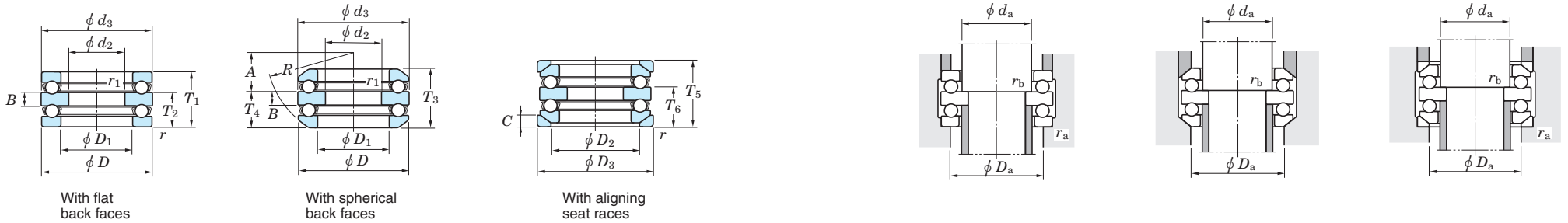

d_2	Boundary dimensions (mm)						Basic load ratings (kN)		Fatigue load limit (kN)	Limiting speeds (min^{-1})		Bearing No.			Dimensions (mm)										Mounting dimensions (mm)				(Refer.) Mass (kg)		
	D	T_1	T_3	T_5	r_{min}	$r_{1 \text{ min}}$	C_a	C_{0a}	C_u	Grease lub.	Oil lub.	With flat back faces	With spherical back faces	With aligning seat races	d_3 max.	D_1 min.	D_2	D_3	T_2	T_4	T_6	A	R	B	C	d_a min.	D_a max.	r_a max.	r_b max.	With flat back faces	With aligning seat races
10	32	22	24.6	28	0.6	0.3	20.8	24.8	1.10	4 900	7 500	52202	54202	54202U	32	17	24	35	13.5	14.8	16.5	10.5	28	5	4	15	24	0.6	0.3	0.085	0.118
	60	45	49.8	55	1	0.6	69.5	89.4	4.05	2 600	4 000	52405	54405	54405U	60	27	42	62	28	30.4	33	15	50	11	8	25	42	1	0.6	0.630	0.804
20	47	28	31.4	36	0.6	0.3	34.6	50.4	2.30	3 600	5 500	52205	54205	54205U	47	27	36	50	17.5	19.2	21.5	16.5	40	7	5.5	25	36	0.6	0.3	0.230	0.304
	52	34	37.6	42	1	0.3	44.7	61.4	2.75	3 100	4 800	52305	54305	54305U	52	27	38	55	21	22.8	25	18	45	8	6	25	38	1	0.3	0.330	0.428
	70	52	56.2	62	1	0.6	91.0	126	5.70	2 200	3 400	52406	54406	54406U	70	32	50	75	32	34.1	37	16	56	12	9	30	50	1	0.6	1.00	1.25
25	52	29	32.6	37	0.6	0.3	36.7	54.3	2.65	3 400	5 200	52206	54206	54206U	52	32	42	55	18	19.8	22	20	45	7	5.5	30	42	0.6	0.3	0.270	0.346
	60	38	41.2	46	1	0.3	53.5	78.7	3.55	2 700	4 200	52306	54306	54306U	60	32	45	62	23.5	25.1	27.5	19.5	50	9	7	30	45	1	0.3	0.490	0.602
	80	59	63	69	1.1	0.6	109	155	7.00	1 900	2 900	52407	54407	54407U	80	37	58	85	36.5	38.5	41.5	18.5	64	14	10	35	58	1	0.6	1.44	1.79
30	62	34	37.8	42	1	0.3	48.9	83.8	3.55	2 900	4 500	52207	54207	54207U	62	37	48	65	21	22.9	25	21	50	8	7	35	48	1	0.3	0.420	0.544
	68	36	38.6	44	1	0.6	58.7	98.3	4.45	2 700	4 200	52208	54208	54208U	68	42	55	72	22.5	23.8	26.5	25	56	9	7	40	55	1	0.6	0.540	0.680
	68	44	47.2	52	1	0.3	69.3	105	4.75	2 400	3 700	52307	54307	54307U	68	37	52	72	27	28.6	31	21	56	10	7.5	35	52	1	0.3	0.710	0.898
	78	49	54	59	1	0.6	86.6	135	6.05	2 100	3 300	52308	54308	54308U	78	42	60	82	30.5	33	35.5	23.5	64	12	8.5	40	60	1	0.6	1.06	1.34
90	65	69.4	77	1.1	0.6	141	205	9.25	1 700	2 600	52408	54408	54408U	90	42	65	95	40	42.2	46	22	72	15	12	40	65	1	0.6	2.03	2.55	
35	73	37	39.6	45	1	0.6	59.7	105	4.75	2 600	4 000	52209	54209	54209U	73	47	60	78	23	24.3	27	23	56	9	7.5	45	60	1	0.6	0.620	0.784
	85	52	56.2	62	1	0.6	100	163	7.40	1 900	3 000	52309	54309	54309U	85	47	65	90	32	34.1	37	21	64	12	10	45	65	1	0.6	1.29	1.62
	100	72	78.8	86	1.1	0.6	162	242	10.9	1 500	2 300	52409	54409	54409U	100	47	72	105	44.5	47.9	51.5	23.5	80	17	12.5	45	72	1	0.6	2.91	3.42
40	78	39	42	47	1	0.6	60.6	111	5.05	2 300	3 600	52210	54210	54210U	78	52	62	82	24	25.5	28	30.5	64	9	7.5	50	62	1	0.6	0.710	0.890
	95	58	64.6	70	1.1	0.6	121	186	9.10	1 800	2 700	52310	54310	54310U	95	52	72	100	36	39.3	42	23	72	14	11	50	72	1	0.6	1.86	2.35
	110	78	83.2	92	1.5	0.6	185	283	12.8	1 400	2 100	52410	54410	54410U	110	52	80	115	48	50.6	55	30	90	18	14	50	80	1.5	0.6	3.56	4.39
45	90	45	49.6	55	1	0.6	86.7	159	7.20	2 100	3 200	52211	54211	54211U	90	57	72	95	27.5	29.8	32.5	32.5	72	10	9	55	72	1	0.6	1.12	1.44
	105	64	72.6	78	1.1	0.6	149	246	11.1	1 600	2 400	52311	54311	54311U	105	57	80	110	39.5	43.8	46.5	25.5	80	15	11.5	55	80	1	0.6	2.51	3.21
	120	87	92	101	1.5	0.6	223	359	16.2	1 200	1 900	52411	54411	54411U	120	57	88	125	53.5	56	60.5	22.5	90	20	15.5	55	88	1.5	0.6	4.70	5.62
50	95	46	50	56	1	0.6	92.0	179	8.05	1 900	3 000	52212	54212	54212U	95	62	78	100	28	30	33	30.5	72	10	9	60	78	1	0.6	1.25	1.57
	110	64	70.6	78	1.1	0.6	154	267	12.1	1 500	2 300	52312	54312	54312U	110	62	85	115	39.5	42.8	46.5	36.5	90	15	11.5	60	85	1	0.6	2.68	3.37
	130	93	99	107	1.5	0.6	267	397	19.7	1 100	1 700	52412	54412	54412U	130	62	95	135	57	60	64	28	100	21	16	60	95	1.5	0.6	6.33	7.60

[Remark] Standard cage types used for the above bearings are described earlier in this section.

Double direction thrust ball bearings

d_2 (50) ~ 95 mm

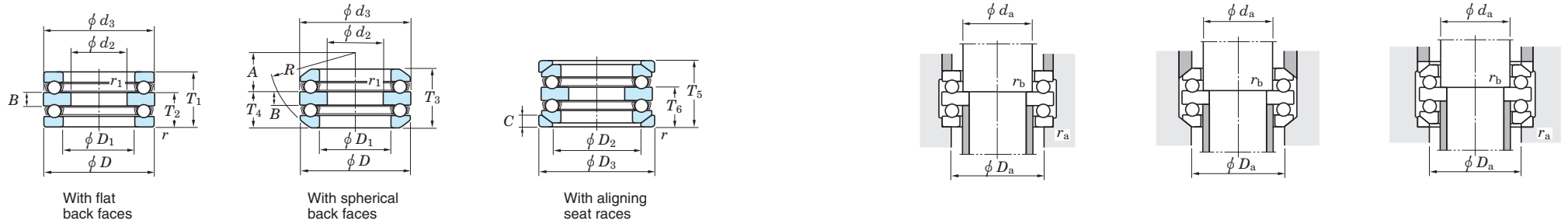

d_2	Boundary dimensions (mm)					Basic load ratings (kN)		Fatigue load limit (kN) C_u	Limiting speeds (min^{-1})		Bearing No.			Dimensions (mm)								Mounting dimensions (mm)				(Refer.) Mass (kg)					
	D	T_1	T_3	T_5	r_{min}	$r_{1 \text{ min}}$	C_a		C_{0a}	Grease lub.	Oil lub.	With flat back faces	With spherical back faces	With aligning seat races	d_3 max.	D_1 min.	D_2	D_3	T_2	T_4	T_6	A	R	B	C	d_a min.	D_a max.	r_a max.	r_b max.	With flat back faces	With aligning seat races
50	140	101	109.4	119	2	1	290	493	22.0	1 000	1 600	52413	54413	54413U	140	68	100	145	62	66.2	71	34	112	23	17.5	65	100	2	1	8.03	9.72
55	100	47	50.4	57	1	0.6	93.6	189	8.50	1 900	2 900	52213	54213	54213U	100	67	82	105	28.5	30.2	33.5	38.5	80	10	9	65	82	1	0.6	1.36	1.70
	105	47	50.6	57	1	1	95.2	189	8.95	1 800	2 800	52214	54214	54214U	105	72	88	110	28.5	30.3	33.5	36.5	80	10	9	70	88	1	1	1.48	1.84
	115	65	71.8	79	1.1	0.6	159	287	13.0	1 400	2 200	52313	54313	54313U	115	67	90	120	40	43.4	47	34.5	90	15	12.5	65	90	1	0.6	2.90	3.66
	125	72	80.4	88	1.1	1	167	339	13.1	1 300	2 000	52314	54314	54314U	125	72	98	130	44	48.2	52	39	100	16	13	70	98	1	1	3.90	4.78
	150	107	114.2	125	2	1	312	553	23.8	940	1 450	52414	54414	54414U	150	73	110	155	65.5	69.1	74.5	28.5	112	24	19.5	70	110	2	1	9.71	11.6
60	110	47	49.6	57	1	1	96.7	209	9.40	1 800	2 700	52215	54215	54215U	110	77	92	115	28.5	29.8	33.5	47.5	90	10	9.5	75	92	1	1	1.57	1.96
	135	79	87.2	95	1.5	1	192	396	15.0	1 200	1 900	52315	54315	54315U	135	77	105	140	48.5	52.6	56.5	32.5	100	18	15	75	105	1.5	1	4.83	6.08
	160	115	123	135	2	1	315	560	23.3	880	1 350	52415	54415	54415U	160	78	115	165	70.5	74.5	80.5	36.5	125	26	21	75	115	2	1	11.8	14.3
65	115	48	51	58	1	1	98.1	218	9.85	1 700	2 600	52216	54216	54216U	115	82	98	120	29	30.5	34	45	90	10	10	80	98	1	1	1.69	2.09
	140	79	86.2	95	1.5	1	200	424	15.8	1 200	1 800	52316	54316	54316U	140	82	110	145	48.5	52.1	56.5	45.5	112	18	15	80	110	1.5	1	5.06	6.36
	170	120	128.4	140	2.1	1	337	621	25.1	810	1 250	52416	54416	54416U	170	83	125	175	73.5	77.7	83.5	30.5	125	27	22	80	125	2	1	14.0	16.6
	180	128	138	150	2.1	1.1	384	753	29.5	780	1 200	52417	54417	54417U	179.5	88	130	185	78.5	83.5	89.5	40.5	140	29	23	85	130	2	1	17.5	19.7
70	125	55	59.2	67	1	1	119	251	11.6	1 500	2 300	52217	54217	54217U	125	88	105	130	33.5	35.6	39.5	49.5	100	12	11	85	105	1	1	2.34	2.90
	150	87	95.2	105	1.5	1	232	489	17.5	1 100	1 700	52317	54317	54317U	150	88	115	155	53	57.1	62	39	112	19	17.5	85	115	1.5	1	6.43	8.03
	190	135	143.4	157	2.1	1.1	409	826	31.5	710	1 100	52418	54418	54418U	189.5	93	140	195	82.5	86.7	93.5	34.5	140	30	25.5	90	140	2	1	19.6	22.8
75	135	62	69	76	1.1	1	146	326	13.9	1 400	2 100	52218	54218	54218U	135	93	110	140	38	41.5	45	42	100	14	13.5	90	110	1	1	3.22	4.07
	155	88	97.2	106	1.5	1	242	524	18.5	1 000	1 600	52318	54318	54318U	155	93	120	160	53.5	58.1	62.5	36.5	112	19	18	90	120	1.5	1	6.60	8.44
80	210	150	160	176	3	1.1	460	983	35.7	620	950	52420	54420	54420U	209.5	103	155	220	91.5	96.5	104.5	43.5	160	33	27	100	155	2.5	1	26.6	32.0
85	150	67	72.8	81	1.1	1	183	410	16.6	1 200	1 900	52220	54220	54220U	150	103	125	155	41	43.9	48	49	112	15	14	100	125	1	1	4.29	5.25
	170	97	105.4	115	1.5	1	296	596	23.2	940	1 450	52320	54320	54320U	170	103	135	175	59	63.2	68	42	125	21	18	100	135	1.5	1	8.90	10.8
90	230	166	—	—	3	1.1	474	1 070	37.1	550	850	52422	—	—	229	113	—	—	101.5	—	—	—	—	37	—	110	170	2.5	1	34.9	—
95	160	67	71.4	81	1.1	1	191	431	17.6	1 200	1 800	52222	54222	54222U	160	113	135	165	41	43.2	48	62	125	15	14	110	135	1	1	4.68	5.66
	190	110	118.4	128	2	1	334	754	25.9	810	1 250	52322	54322	54322U	189.5	113	150	195	67	71.2	76	47	140	24	20.5	110	150	2	1	13.8	16.3
	250	177	—	—	4	1.5	601	1 460	48.5	520	800	52424	—	—	249	123	—	—	108.5	—	—	—	—	40	—	120	185	3	1.5	44.2	—

[Remark] Standard cage types used for the above bearings are described earlier in this section.

Double direction thrust ball bearings

d_2 100 ~ 190 mm

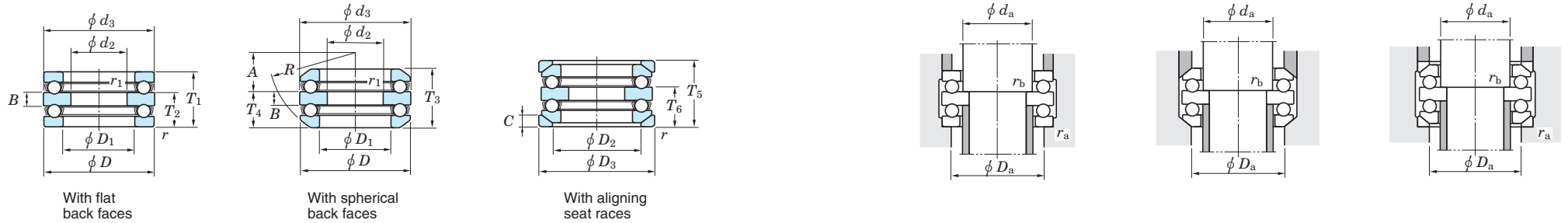

d_2	Boundary dimensions (mm)					Basic load ratings (kN)		Fatigue load limit (kN) C_u	Limiting speeds (min^{-1})		Bearing No.			Dimensions (mm)										Mounting dimensions (mm)				(Refer.) Mass (kg)			
	D	T_1	T_3	T_5	r_{min}	r_1	C_a		C_{0a}	Grease lub.	Oil lub.	With flat back faces	With spherical back faces	With aligning seat races	d_3 max.	D_1 min.	D_2	D_3	T_2	T_4	T_6	A	R	B	C	d_a min.	D_a max.	r_a max.	r_b max.	With flat back faces	With aligning seat races
100	170	68	71.6	82	1.1	1.1	192	472	17.7	1 100	1 700	52224	54224	54224U	170	123	145	175	41.5	43.3	48.5	58.5	125	15	15	120	145	1	1	5.24	6.44
	210	123	131.2	143	2.1	1.1	389	931	30.5	710	1 100	52324	54324	54324U	209.5	123	165	220	75	79.1	85	58	160	27	22	120	165	2	1	17.2	22.9
	270	192	—	—	4	2	623	1 540	49.0	490	750	52426	—	—	269	134	—	—	117	—	—	—	—	42	—	130	200	3	2	56.5	—
110	190	80	85.8	96	1.5	1.1	254	622	22.2	970	1 500	52226	54226	54226U	189.5	133	160	195	49	51.9	57	63	140	18	17	130	160	1.5	1	7.72	9.29
	225	130	—	—	2.1	1.1	413	1 030	32.5	650	1 000	52326	—	—	224	134	—	—	80	—	—	—	—	30	—	130	177	2	1	22.1	—
	280	196	—	—	4	2	650	1 680	52.2	450	700	52428	—	—	279	144	—	—	120	—	—	—	—	44	—	140	206	3	2	60.6	—
120	200	81	86.2	99	1.5	1.1	234	669	19.6	940	1 450	52228	54228	54228U	199.5	143	170	210	49.5	52.1	58.5	83.5	160	18	17	140	170	1.5	1	8.31	10.5
	240	140	—	—	2.1	1.1	458	1 130	36.9	620	950	52328	—	—	239	144	—	—	85.5	—	—	—	—	31	—	140	190	2	1	27.8	—
	300	209	—	—	4	2	711	1 910	57.4	420	650	52430	—	—	299	154	—	—	127.5	—	—	—	—	46	—	150	225	3	2	73.9	—
130	215	89	95.6	109	1.5	1.1	266	768	21.8	840	1 300	52230	54230	54230U	214.5	153	180	225	54.5	57.8	64.5	74.5	160	20	20.5	150	180	1.5	1	10.6	13.6
	250	140	—	—	2.1	1.1	451	1 200	36.0	580	900	52330	—	—	249	154	—	—	85.5	—	—	—	—	31	—	150	200	2	1	29.2	—
	320	226	—	—	5	2	852	2 410	70.3	390	600	52432	—	—	319	164	—	—	138	—	—	—	—	50	—	160	240	4	2	90.3	—
135	340	236	—	—	5	2.1	943	2 730	77.2	360	550	52434	—	—	339	174	—	—	143	—	—	—	—	50	—	170	255	4	2	108	—
140	225	90	97.4	110	1.5	1.1	279	803	23.4	810	1 250	52232	54232	54232U	224.5	163	190	235	55	58.7	65	70	160	20	21	160	190	1.5	1	12.2	14.6
	270	153	—	—	3	1.1	512	1 570	41.3	550	850	52332	—	—	269	164	—	—	93	—	—	—	—	33	—	160	215	2.5	1	37.7	—
	360	245	—	—	5	3	928	2 730	75.1	320	500	52436	—	—	359	184	—	—	148.5	—	—	—	—	52	—	180	270	4	2.5	126	—
150	240	97	104.4	117	1.5	1.1	326	874	26.3	750	1 150	52234	54234	54234U	239.5	173	200	250	59	62.7	69	87	180	21	21.5	170	200	1.5	1	15.2	17.8
	250	98	102.4	118	1.5	2	332	986	26.9	710	1 100	52236	54236	54236U	249	183	210	260	59.5	61.7	69.5	108.5	200	21	21.5	180	210	1.5	2	15.9	19.6
	280	153	—	—	3	1.1	579	1 570	47.4	520	800	52334	—	—	279	174	—	—	93	—	—	—	—	33	—	170	220	2.5	1	39.6	—
	300	165	—	—	3	2	578	1 580	46.2	490	750	52336	—	—	299	184	—	—	101	—	—	—	—	37	—	180	240	2.5	2	50.9	—
160	270	109	116.4	131	2	2	385	1 010	31.4	650	1 000	52238	54238	54238U	269	194	220	280	66.5	70.2	77.5	93.5	200	24	23	190	230	2	2	21.6	25.2
	320	183	—	—	4	2	679	1 950	55.3	440	680	52338	—	—	319	195	—	—	111.5	—	—	—	—	40	—	190	255	3	2	64.9	—
170	280	109	115.6	133	2	2	392	1 110	32.2	620	950	52240	54240	54240U	279	204	240	290	66.5	69.8	78.5	120.5	225	24	23	200	240	2	2	22.7	27.3
	340	192	—	—	4	2	745	2 220	61.1	420	650	52340	—	—	339	205	—	—	117	—	—	—	—	42	—	200	270	3	2	77.8	—
190	300	110	115.2	134	2	2	428	1 310	36.6	580	900	52244	54244	54244U	299	224	260	310	67	69.6	79	114	225	24	25	220	260	2	2	23.9	29.5

[Remark] Standard cage types used for the above bearings are described earlier in this section.

Spherical thrust roller bearings

Spherical thrust roller bearings

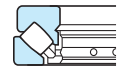

Bore diameter **60 – 500 mm**

Spherical thrust roller bearings are designed to carry high axial loads. They can also support radial load if magnitude is no more than 55 % of the axial load being carried.

These bearings are not suitable for high-speed rotation.

Having a spherical housing race raceway surface, these bearings are self-aligning, adjusting to axial inclination.

They are usually used with oil lubrication.



Boundary dimensions	As specified in JIS B 1512.
Tolerances	As specified in JIS B 1514-2, class 0. (refer to table 7-10 on p. A 75.)
Recommended fits	Refer to Table 9-8 on p. A 98.
Required minimum axial load	A certain degree of load is necessary in order for bearings to operate satisfactorily. (refer to p. A 116.)
Standard cage	Copper alloy machined cage (supplementary code : FY)
Allowable aligning angle	0.035 – 0.052 rad (2° – 3°) in general, depending on bearing series.
Equivalent axial load	Dynamic equivalent axial load $P_a = 1.2F_r + F_a$ Static equivalent axial load $P_{0a} \doteq 2.7F_r + F_a$ (Note : $F_r / F_a \leq 0.55$)

Spherical thrust roller bearings

d 60 ~ 160 mm

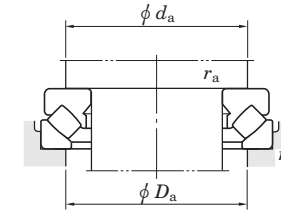
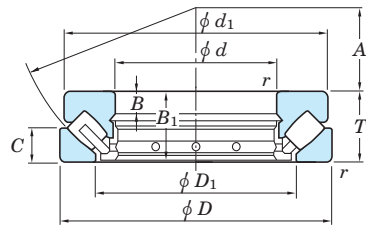

Boundary dimensions (mm)				Basic load ratings (kN)		Fatigue load limit (kN)	Limiting speed (min ⁻¹)	Bearing No.	Dimensions (mm)						Mounting dimensions (mm)			(Refer.) Mass (kg)
d	D	T	$r_{min.}$	C_a	C_{0a}	C_u	Oil lub.		d_1	D_1	B	B_1	C	A	d_a min.	D_a max.	r_a max.	Mass
60	130	42	1.5	399	884	73.7	2 700	29412R	123	89	15	39.5	20	38	90	108	1.5	2.75
65	140	45	2	450	1 020	73.4	2 500	29413R	133	96	16	42.5	21	42	100	115	2	3.41
70	150	48	2	485	1 100	105	2 300	29414R	142	103	17	45.5	23	44	105	125	2	4.16
75	160	51	2	584	1 360	102	2 100	29415R	152	109	18	48	24	47	115	132	2	4.98
80	170	54	2.1	631	1 480	128	2 000	29416R	162	117	19	51	26	50	120	140	2	5.95
85	150	39	1.5	400	1 000	100	2 600	29317R	143.5	114	13	37	19	50	115	135	1.5	2.87
	180	58	2.1	714	1 700	124	1 900	29417R	170	125	21	55	28	54	130	150	2	7.19
90	155	39	1.5	412	1 050	103	2 500	29318R	148.5	117	13	37	19	52	120	140	1.5	3.06
	190	60	2.1	821	2 010	158	1 800	29418R	180	132	22	57	29	56	135	157	2	8.28
100	170	42	1.5	481	1 270	118	2 300	29320R	163	129	14	40	20.8	58	130	150	1.5	3.91
	210	67	3	911	2 220	166	1 650	29420R	200	146	24	64	32	62	150	175	2.5	11.2
110	190	48	2	628	1 690	147	2 000	29322R	182	143	16	45.5	23	64	145	165	2	5.67
	230	73	3	1 120	2 810	203	1 500	29422R	220	162	26	69	35	69	165	190	2.5	14.7
120	210	54	2.1	759	2 030	182	1 800	29324R	200	159	18	51	26	70	160	180	2	7.90
	250	78	4	1 300	3 270	241	1 350	29424R	236	174	29	74	37	74	180	205	3	18.5
130	225	58	2.1	894	2 440	209	1 700	29326R	215	171	19	55	28	76	170	195	2	9.45
	270	85	4	1 490	3 870	270	1 250	29426R	255	189	31	81	41	81	195	225	3	23.5
140	240	60	2.1	898	2 490	206	1 600	29328R	230	183	20	57	29	82	185	205	2	11.1
	280	85	4	1 560	4 080	289	1 250	29428R	268	199	31	81	41	86	205	235	3	24.6
150	250	60	2.1	965	2 740	233	1 550	29330R	240	194	20	57	29	87	195	215	2	11.7
	300	90	4	1 730	4 620	334	1 100	29430R	285	214	32	86	44	92	220	250	3	29.6
160	270	67	3	1 150	3 070	272	1 400	29332R	260	208	23	64	32	92	210	235	2.5	15.4
	320	95	5	1 990	5 370	375	1 050	29432R	306	229	34	91	45	99	230	265	4	35.9

Spherical thrust roller bearings

d 170 ~ 320 mm

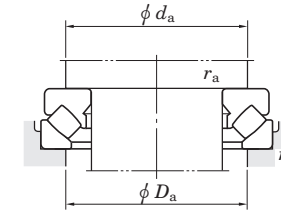
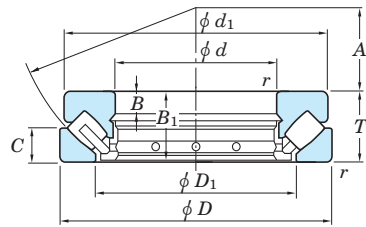

Boundary dimensions (mm)				Basic load ratings (kN)		Fatigue load limit	Limiting speed (min ⁻¹)	Bearing No.	Dimensions (mm)						Mounting dimensions (mm)			(Refer.) Mass (kg)
d	D	T	r _{min.}	C _a	C _{0a}	(kN) C _u	Oil lub.		d ₁	D ₁	B	B ₁	C	A	d _a min.	D _a max.	r _a max.	Mass
170	280	67	3	1 190	3 180	286	1 350	29334R 29434R	270	216	23	64	32	96	220	245	2.5	15.4
	340	103	5	2 120	5 880	389	950		324	243	37	99	50	104	245	285	4	44.0
180	300	73	3	1 380	3 170	330	1 250	29336R 29436R	290	232	25	69	35	103	235	260	2.5	20.7
	360	109	5	2 450	6 590	447	900		342	255	39	105	52	110	260	300	4	52.2
190	320	78	4	1 570	4 230	369	1 150	29338R 29438R	308	246	27	74	38	110	250	275	3	25.1
	380	115	5	2 790	7 690	504	850		360	271	41	111	55	117	275	320	4	61.4
200	280	48	2	641	2 170	151	1 600	29240 29340R 29440R	271	236	15	45	24	108	235	255	2	8.90
	340	85	4	1 810	5 040	415	1 050		325	261	29	81	41	116	265	295	3	31.2
	400	122	5	3 060	8 470	575	800		380	286	43	117	59	122	290	335	4	73.0
220	300	48	2	670	2 340	148	1 550	29244 29344R 29444R	292	254	15	45	24	117	260	275	2	10.0
	360	85	4	1 840	5 240	439	1 000		345	280	29	81	41	125	285	315	3	33.3
	420	122	6	3 160	8 990	619	750		400	308	43	117	58	132	310	355	5	74.2
240	340	60	2.1	1 030	3 670	233	1 250	29248 29348A 29448R	330	283	19	57	30	130	285	305	2	16.7
	380	85	4	1 790	5 330	99.3	950		365	300	29	81	41	135	300	330	3	35.5
	440	122	6	3 260	9 510	659	700		420	326	43	117	59	142	330	375	5	83.0
260	360	60	2.1	1 050	3 720	240	1 200	29252 29352 29452R	350	302	19	57	30	139	305	325	2	18.5
	420	95	5	1 960	6 040	389	850		405	329	32	91	45	148	330	365	4	51.5
	480	132	6	3 760	11 100	764	650		460	357	48	127	64	154	360	405	5	110
280	380	60	2.1	1 030	3 730	225	1 150	29256 29356 29456R	370	323	19	57	30	150	325	345	2	19.5
	440	95	5	2 200	6 870	439	800		423	348	32	91	46	158	350	390	4	53.2
	520	145	6	4 560	13 600	907	550		495	387	52	140	68	166	390	440	5	137
300	420	73	3	1 330	4 880	302	950	29260 29360 29460R	405	353	21	69	38	162	355	380	2.5	30.5
	480	109	5	2 470	7 780	496	700		460	379	37	105	50	168	380	420	4	74.9
	540	145	6	4 670	14 900	925	550		515	402	52	140	70	175	410	460	5	146
320	440	73	3	1 780	6 480	321	900	29264R 29364 29464R	430	372	21	69	38	172	375	400	2.5	32.7
	500	109	5	2 890	9 380	573	650		482	399	37	105	53	180	400	440	4	78.0
	580	155	7.5	5 190	16 100	1 040	500		555	435	55	149	75	191	435	495	6	179

Spherical thrust roller bearings

d 340 ~ 500 mm

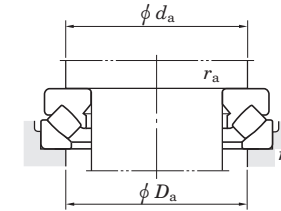
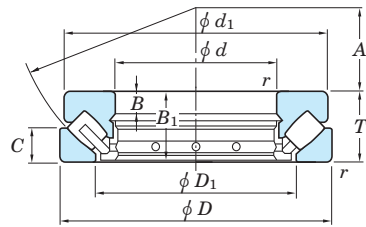

Boundary dimensions (mm)				Basic load ratings (kN)		Fatigue load limit	Limiting speed	Bearing No.	Dimensions (mm)						Mounting dimensions (mm)			(Refer.)
d	D	T	$r_{min.}$	C_a	C_{0a}	(kN) C_u	(min^{-1}) Oil lub.		d_1	D_1	B	B_1	C	A	d_a min.	D_a max.	r_a max.	Mass (kg)
340	460	73	3	1 800	6 420	307	900	29268R	445	395	21	69	37	183	395	420	2.5	34.7
	540	122	5	3 810	12 700	890	600	29368R	520	428	41	117	59	192	430	470	4	106
	620	170	7.5	6 190	19 400	1 210	450	29468R	590	462	61	164	82	201	465	530	6	224
360	500	85	4	1 650	6 080	332	750	29272	485	423	25	81	44	194	420	455	3	51.8
	560	122	5	3 890	13 200	923	550	29372R	540	448	41	117	59	202	450	495	4	110
	640	170	7.5	6 440	20 600	1 300	450	29472R	610	480	61	164	82	210	485	550	6	231
380	520	85	4	1 750	6 610	343	700	29276	505	441	27	81	42	202	440	475	3	52.8
	600	132	6	4 430	15 000	1 030	500	29376R	580	477	44	127	63	216	480	525	5	141
	670	175	7.5	6 780	22 000	1 300	410	29476R	640	504	63	168	85	230	510	575	6	263
400	540	85	4	1 980	7 610	377	700	29280	526	460	27	81	42	212	460	490	3	55.3
	620	132	6	4 630	16 100	1 080	500	29380R	596	494	44	127	64	225	500	550	5	144
	710	185	7.5	7 750	25 300	1 530	380	29480R	680	534	67	178	89	236	540	610	6	315
420	580	95	5	2 310	8 750	463	600	29284	564	489	30	91	46	225	490	525	4	75.4
	650	140	6	5 070	17 700	1 160	450	29384R	626	520	48	135	68	235	525	575	5	169
	730	185	7.5	7 960	26 500	1 630	370	29484R	700	556	67	178	89	244	560	630	6	330
440	600	95	5	2 340	8 970	441	600	29288	585	508	30	91	49	235	510	545	4	77.9
	680	145	6	5 360	18 800	1 250	420	29388R	655	548	49	140	70	245	550	600	5	190
	780	206	9.5	9 100	30 000	1 800	320	29488R	745	588	74	199	100	260	595	670	8	423
460	620	95	5	2 460	9 620	440	550	29292	605	530	30	91	46	245	530	570	4	81.0
	710	150	6	4 580	15 800	875	400	29392	685	567	51	144	72	257	575	630	5	216
	800	206	9.5	9 360	31 600	1 870	300	29492R	765	608	74	199	100	272	615	690	8	438
480	650	103	5	2 880	11 600	531	500	29296	635	556	33	99	55	259	555	595	4	89.0
	850	224	9.5	10 900	36 300	2 100	270	29496R	810	638	81	216	108	280	645	730	8	548
500	870	224	9.5	10 800	36 400	2 120	270	294/500R	830	661	81	216	107	290	670	750	8	562

Needle roller bearings

Needle roller bearings are small in sectional height, therefore useful in making machinery smaller and lighter. This type of bearing is used in a wide range of machinery, such as automobiles, motor cycles, electric machines, machine tools, aerospace and office equipment.

- Compact, highly rigid and superior in load carrying performance, compared with other types of bearings.
- Excellent for carrying oscillating loads; contains many small diameter rollers.
- Widely employed in stud type and yoke type track rollers used as guide rollers in cam mechanisms or linear motion units. Allowable loads of these truck rollers are examined with load ratings different from those of general bearings. For detailed information, contact us.
Also used in miniature one-way clutches in the clutch mechanisms of office equipment, such as copying machines.

The catalog also covers bearings employing rollers other than those prescribed in JIS B 1506 "rollers for roller bearings".

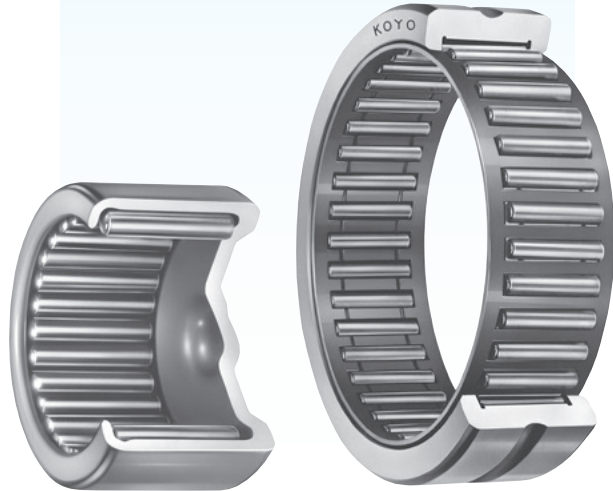

Needle roller and cage assemblies

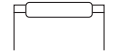

Bore diameter of a needle roller and cage assembly

Metric series **3 – 110 mm**

Inch series **9.525 – 127.000 mm**

Drawn cup needle roller bearings



Metric series Roller set bore dia. **3 – 60 mm**

Inch series Roller set bore dia. **3.175 – 69.850 mm**

Heavy-duty needle roller bearings

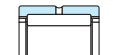

Metric series Roller set bore dia. **5 – 175 mm**

Inch series Roller set bore dia. **15.875 – 88.900 mm**

Needle roller thrust bearings



Metric series Bore dia. **6 – 160 mm**

Inch series Bore dia. **6.350 – 104.780 mm**

Cylindrical roller thrust bearings

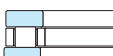

Bore dia. **15 – 90 mm**

Combined needle roller bearings

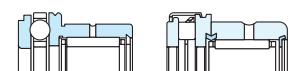

Roller set bore dia. **10 – 70 mm**

Inner rings



Metric series Bore dia. **5 – 180 mm**

Inch series Bore dia. **9.525 – 76.2 mm**

Miniature one-way clutches (Refer.)



Roller set bore dia. **4 – 12 mm**

For details, refer to JTEKT separate catalog "Needle Roller Bearings" (CAT. NO. B2020E)

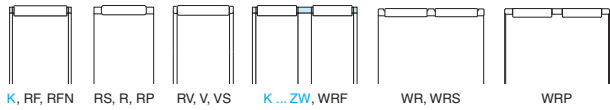

Table 1 (1) Types of needle roller bearing

(1) Radial Needle Roller and Cage Assemblies

Metric Series Inch Series

Single-Row, Double-Row



Single-Row

Metric Series

Assemblies for Crank Pin End Applications



Assemblies for Wrist Pin End Applications

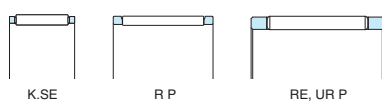

(2) Drawn Cup Needle Roller Bearings

Metric Series (Caged)

Open Ends, Closed One End

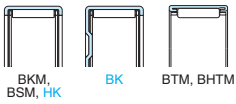

Sealed

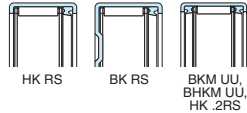

(Full Complement)

Open Ends, Closed One End

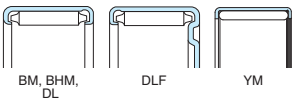

Inch Series (Caged)

Open Ends, Closed One End



Sealed

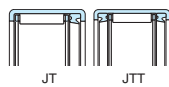

(Full Complement)

Open Ends, Closed One End

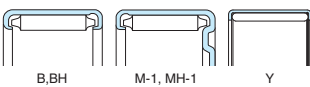

Extra-Precision



Inner Rings

Inch Series

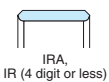

The needle roller bearings explained in this catalog are indicated in blue.
For additional details on Koyo's Needle Roller Bearing product line please refer to Catalog B2020E.

(3) Drawn Cup Roller Clutches

Metric Series

Clutches

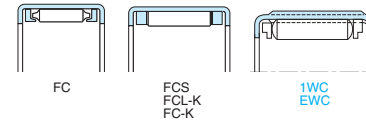

Clutch and Bearing Assemblies

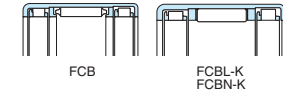

Inch Series

Clutches

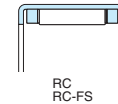

Clutch and Bearing Assemblies

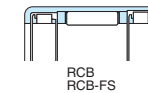

(4) Heavy-Duty Needle Roller Bearings

Metric Series (Caged, With Inner Ring)

Unsealed

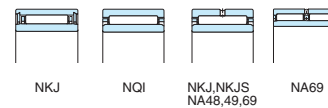

Sealed

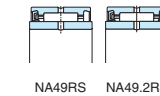

Without Flanges

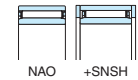

(Without Inner Ring)

Unsealed

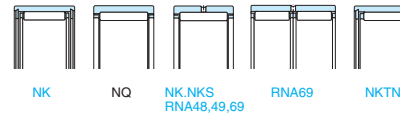

Sealed

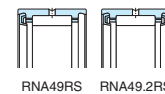

Without Flanges

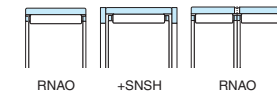

(Full Complement) Inch Series (Without Inner Ring) Inner Rings

With Inner Ring Without Inner Ring

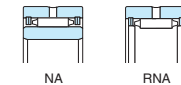

Unsealed



Sealed

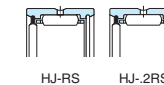

Inch Series



Table 1 (2) Types of needle roller bearing

(5) Track Rollers

[Stud-Type]

Metric Series (Caged)



(Full Complement)

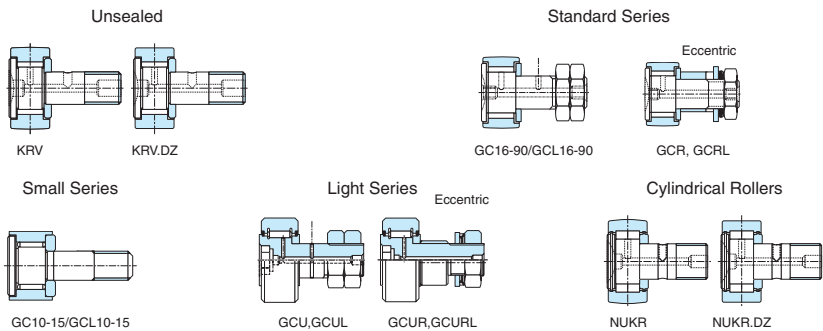

[Yoke-Type]

Metric Series (Caged, Without End Washers)

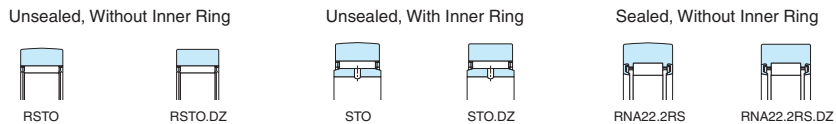

(Caged, Without End Washers)

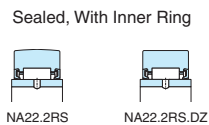

(Caged, With End Washers)

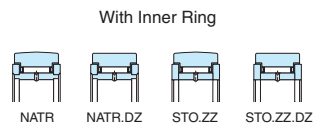

(Full Complement, With End Washers)



(Full Complement, With Metal Seals)

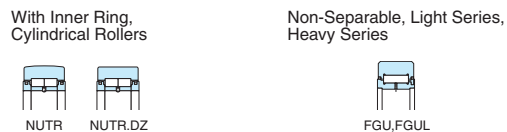

(6) Thrust Bearings, Assemblies, Washers

Metric Series

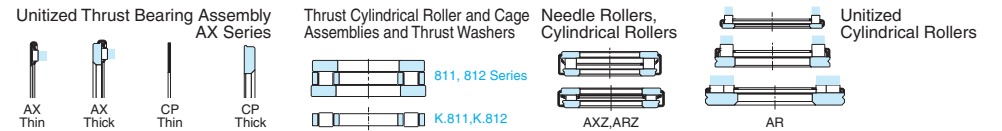

Inch Series

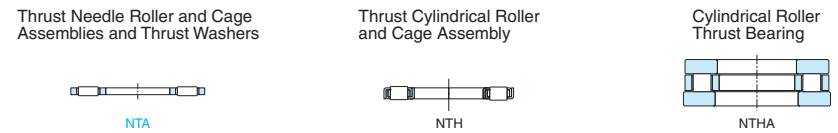

(7) Combined Needle Roller Bearings

Metric Series (Heavy-Duty, Without Inner Ring)

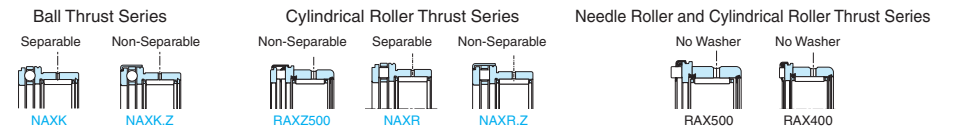

(Drawn Cup, Without Inner Ring)

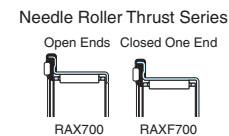

(8) Needle Rollers, Accessories

Inner Rings (Caged)

<Metric Series>

For Drawn Cup Needle Roller Bearings, Heavy-Duty

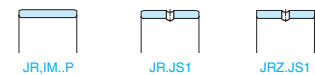

(Full Complement)

For Drawn Cup Needle Roller Bearings

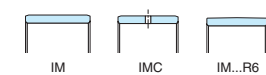

For Machine-Tool Quality Precision-Combined Bearings

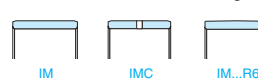

For RNA Bearings (With Oil Holes, Extra Wide)

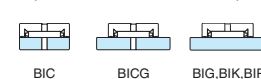

For Metric Series NAO and RNAO Bearings



[Tolerances of needle roller bearings]

Table 2 Tolerance grades of needle rollers (JIS B 1506)

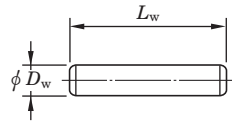

Unit : μm

Class	Single ¹⁾ plane diameter variation V_{Dwp} max.	Deviation ¹⁾ from circular form Δ_{Rw} max.	Gauge lot ¹⁾ diameter variation V_{DwL} max.
2	1	1	2
3	1.5	1.5	3
5	2	2.5	5

Class	Actual ²⁾ length deviation Δ_{Lws}	Recommended gauge S
2	h 13	0/- 2, - 1/- 3, - 2/- 4, - 3/- 5, - 4/- 6, - 5/- 7, - 6/- 8, - 7/- 9, - 8/- 10
3		0/- 3, - 1.5/- 4.5, - 3/- 6, - 4.5/- 7.5, - 6/- 9, - 7/- 10
5		0/- 5, - 3/- 8, - 5/- 10

[Notes] 1) Values apply only at middle of roller length.
2) Applied tolerance differs according to L_w division.

[Remark] Along the entire length of the roller, all the actually measured diameters should not exceed the actual maximum diameter at the middle of the entire length of the roller by the lengths shown below.
a) Class 2 : 0.5 μm b) Class 3 : 0.8 μm
c) Class 5 : 1 μm

Table 3 Tolerance of needle roller cage width B (JIS B 1536-3)

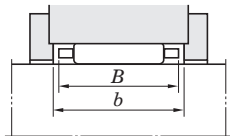

Bearing type	B deviation (mm)	
	upper	lower
K, K...ZW	- 0.2	- 0.55
WJ, WJC	0	- 0.38

[Remark] Values in Italics are prescribed in JTEKT standards.

[Reference] The guide width (b) should satisfy the equation : $b = B + (H11)$

Table 4 Metric series drawn cup needle roller bearing gauge specifications (caged)

Unit : mm

Nominal bore diameter	Ring gage ¹⁾	Needle roller complement bore diameter	
		max.	min.
3	6.484	3.024	3.006
4	7.984	4.028	4.010
5	8.984	5.028	5.010
6	9.984	6.028	6.010
7	10.980	7.031	7.013
8	11.980	8.031	8.013
9	12.980	9.031	9.013
10	13.980	10.031	10.013
12	15.980	12.034	12.016
12	17.980	12.034	12.016
13	18.976	13.034	13.016
14	19.976	14.034	14.016
15	20.976	15.034	15.016
16	21.976	16.034	16.016
17	22.976	17.034	17.016
18	23.976	18.034	18.016
20	25.976	20.041	20.020
22	27.976	22.041	22.020
25	31.972	25.041	25.020
28	34.972	28.041	28.020
30	36.972	30.041	30.020
35	41.972	35.050	35.025
40	46.972	40.050	40.025
45	51.967	45.050	45.025
50	57.967	50.050	50.025
60	67.967	60.060	60.030

[Note] 1) The ring gage sizes are in accordance with ISO N6 lower limit.

Table 5 Inch series drawn cup needle roller bearing gauge specifications (caged)

Unit : mm

Bearing bore designation	Nominal shaft diameter	Nominal bore diameter	Ring gage	Needle roller complement bore diameter	
				max.	min.
2	3.175	3.175	6.363	3.218	3.195
2 1/2	3.970	3.967	7.155	4.013	3.99
3	4.763	4.763	8.730	4.806	4.783
4	6.350	6.350	11.125	6.411	6.388
5	7.938	7.938	12.713	7.998	7.976
H 5	H 7.938	7.938	14.300	7.998	7.976
6	9.525	9.525	14.300	9.586	9.563
H 6	H 9.525	9.525	15.888	9.586	9.563
7	11.113	11.113	15.888	11.174	11.151
H 7	H 11.113	11.113	17.475	11.174	11.151
8	12.700	12.700	17.475	12.761	12.738
H 8	H12.700	12.700	19.063	12.761	12.738
9	14.288	14.288	19.063	14.349	14.326
H 9	H 14.288	14.288	20.650	14.349	14.326
10	15.875	15.875	20.650	14.349	15.913
H 10	H 15.875	15.875	22.238	14.349	15.913
11	17.463	17.463	22.238	17.524	17.501
H 11	H 17.463	17.463	23.825	17.524	17.501
12	19.050	19.050	25.387	19.086	19.063
H 12	H 19.050	19.050	26.975	19.086	19.063
13	20.638	20.638	26.975	20.673	20.650
H 13	H 20.638	20.638	28.562	20.673	20.650
14	22.225	22.225	28.562	22.261	22.238
H 14	H 22.225	22.225	30.150	22.261	22.238
15	23.813	23.813	30.150	23.848	23.825
16	25.400	25.400	31.737	25.436	25.413
H 16	H 25.400	25.400	33.325	25.436	25.413
17	26.988	26.988	33.325	27.023	27.000
18	28.575	28.575	34.912	28.611	28.588
H 18	H 28.575	28.575	38.087	28.611	28.588
19	30.163	30.163	38.087	30.198	30.175
20	31.750	31.750	38.087	31.786	31.763
H 20	H 31.750	31.750	41.262	31.786	31.763
21	33.338	33.338	41.262	33.376	33.350
22	34.925	34.925	41.262	34.963	34.938
H 22	H 34.925	34.925	44.437	34.963	34.938
24	38.100	38.100	47.612	38.141	38.113
26	41.275	41.275	50.787	41.316	41.288
28	44.450	44.450	53.962	44.493	44.463
30	47.625	47.625	57.137	47.668	47.638
32	50.800	50.800	60.312	50.846	50.815
H 33	H 52.388	52.388	64.280	52.436	52.400
34	53.975	53.975	63.487	54.026	53.990
36	57.150	57.150	66.662	57.201	57.165
42	66.675	66.675	76.187	66.736	66.700
44	69.850	69.850	79.362	69.911	69.875
56	88.900	88.900	101.587	88.961	88.925
88	139.700	139.700	152.375	139.774	139.725

[Remark] Bearing bore should be checked with "go" and "no go" plug gages. The "go" gage size is the minimum needle roller complement bore diameter. The "no go" gage size is larger than the maximum needle roller complement bore diameter by 0.0001 in.

Table 6 Metric series caged needle roller complement bore diameter for bearings without inner rings

Unit : mm

F_w		$\Delta F_{w \text{ min.}}$	
over	up to	max.	min.
3	6	+ 0.018	+ 0.010
6	10	+ 0.022	+ 0.013
10	18	+ 0.027	+ 0.016
18	30	+ 0.033	+ 0.020
30	50	+ 0.041	+ 0.025
50	80	+ 0.049	+ 0.030
80	120	+ 0.058	+ 0.036
120	180	+ 0.068	+ 0.043
180	250	+ 0.079	+ 0.050
250	315	+ 0.088	+ 0.056
315	400	+ 0.098	+ 0.062

Table 7 Metric series heavy-duty needle roller bearing tolerances = JIS B 1415 (ISO 492) =

(1) Inner ring

Unit : μm

Nominal bore diameter d (mm)		Single plane mean bore diameter deviation Δ_{dmp}						Single plane bore diameter variation V_{dsp}			Mean bore diameter variation V_{dmp}			Radial runout of assembled bearing inner ring K_{ia}			S_d	Single inner ring width deviation ΔB_s						Inner ring width variation V_{Bs}			
		class 0		class 6		class 5		class 0	class 6	class 5								class 0	class 6	class 5	class 5	class 0		class 6		class 5	
		upper	lower	upper	lower	upper	lower	max.	max.	max.	max.	max.	max.	max.	upper	lower	upper	lower	upper	lower	max.	max.	max.				
2.5	10	0	-8	0	-7	0	-5	10	9	5	6	5	3		10	6	4	7	0	-120	0	-120	0	-40	15	15	5
10	18	0	-8	0	-7	0	-5	10	9	5	6	5	3		10	7	4	7	0	-120	0	-120	0	-80	20	20	5
18	30	0	-10	0	-8	0	-6	13	10	6	8	6	3		13	8	4	8	0	-120	0	-120	0	-120	20	20	5
30	50	0	-12	0	-10	0	-8	15	13	8	9	8	4		15	10	5	8	0	-120	0	-120	0	-120	20	20	5
50	80	0	-15	0	-12	0	-9	19	15	9	11	9	5		20	10	5	8	0	-150	0	-150	0	-150	25	25	6
80	120	0	-20	0	-15	0	-10	25	19	10	15	11	5		25	13	6	9	0	-200	0	-200	0	-200	25	25	7
120	150	0	-25	0	-18	0	-13	31	23	13	19	14	7		30	18	8	10	0	-250	0	-250	0	-250	30	30	8
150	180	0	-25	0	-18	0	-13	31	23	13	19	14	7		30	18	8	10	0	-250	0	-250	0	-250	30	30	8
180	250	0	-30	0	-22	0	-15	38	28	15	23	17	8		40	20	10	11	0	-300	0	-300	0	-300	30	30	10

S_d : Perpendicularity of inner ring face with respect to the bore

(2) Outer ring

Unit : μm

Nominal outside diameter D (mm)		Single plane mean outside diameter deviation Δ_{Dmp}						Single plane outside diameter variation V_{Dsp}			Mean outside diameter variation V_{Dmp}			Radial runout of assembled bearing outer ring K_{ea}			S_D	ΔC_s		Ring width variation V_{Cs}									
		class 0		class 6		class 5		class 0 ¹⁾	class 6 ¹⁾	class 5										class 0 ¹⁾	class 6 ¹⁾	class 5	class 0	class 6	class 5				
		upper	lower	upper	lower	upper	lower	max.	max.	max.	max.	max.	max.	max.	upper	lower	max.												
6	18	0	-8	0	-7	0	-5	10	9	5	6	5	3		15	8	5	8										5	
18	30	0	-9	0	-8	0	-6	12	10	6	7	6	3		15	9	6	8										5	
30	50	0	-11	0	-9	0	-7	14	11	7	8	7	4		20	10	7	8										5	
50	80	0	-13	0	-11	0	-9	16	14	9	10	8	5		25	13	8	8	Shall conform to the tolerance ΔB_s on d of the same bearing	Shall conform to the tolerance V_{Bs} on d of the same bearing						6			
80	120	0	-15	0	-13	0	-10	19	16	10	11	10	5		35	18	10	9											8
120	150	0	-18	0	-15	0	-11	23	19	11	14	11	6		40	20	11	10											8
150	180	0	-25	0	-18	0	-13	31	23	13	19	14	7		45	23	13	10											8
180	250	0	-30	0	-20	0	-15	38	25	15	23	15	8		50	25	15	11										10	
250	315	0	-35	0	-25	0	-18	44	31	18	26	19	9		60	30	18	13										11	

[Note] 1) Shall be applied when locating snap ring is not fitted.

S_D : Perpendicularity of outer ring outside surface with respect to the face

ΔC_s : Deviation of a single outer ring width

Table 8 Inch series heavy-duty needle roller bearing (HJ outer ring)

(1) Outside diameter and width tolerances Unit : mm				(2) Roller complement bore tolerance Unit : mm					
Nominal outside diameter D		Single plane mean outside diameter deviation (D_{mp}) ¹⁾		Deviation from nominal of width (C)		Nominal roller complement bore diameter F_w		Deviation from nominal of the smallest single diameter of the roller complement bore (F_m) ¹⁾	
over	up to	max.	min.	max.	min.	over	up to	max.	min.
19.050	50.800	+0	-0.013			12.700	15.875	+0.043	+0.020
50.800	82.550	+0	-0.015	+0	-0.013	15.875	28.575	+0.046	+0.023
82.550	120.650	+0	-0.020			28.575	41.275	+0.048	+0.025
						41.275	47.625	+0.050	+0.025
						47.625	69.850	+0.053	+0.028
						69.850	76.200	+0.058	+0.028
						76.200	101.600	+0.060	+0.030

[Note] 1) "Single mean diameter" is defined as the mean diameter in a single radial plane.

[Note] 1) "The smallest single diameter of the roller complement bore" is defined as the diameter of the cylinder which, when used as a bearing inner ring, results in zero radial internal clearance in the bearing on at least one diameter.

Table 9 Inch series heavy-duty needle roller bearing (IR inner ring)

(1) Bore and width tolerances Unit : mm				(2) Outside diameter tolerance Unit : mm					
Nominal bore diameter d		Single plane mean bore diameter deviation (d_{mp}) ¹⁾		Deviation from nominal of width (B)		Nominal outside diameter F		Single plane mean outside diameter deviation (F_{mp}) ¹⁾	
over	up to	max.	min.	max.	min.	over	up to	max.	min.
7.938	19.050	+0	-0.010			12.700	15.875	-0.013	-0.023
19.050	50.800	+0	-0.013	+0.25	+0.12	15.875	25.400	-0.018	-0.031
50.800	82.550	+0	-0.015			25.400	28.575	-0.023	-0.036
						28.575	34.925	-0.023	-0.036
						34.925	47.625	-0.025	-0.038
						47.625	76.200	-0.028	-0.040
						76.200	95.250	-0.033	-0.046

[Note] 1) "Single mean diameter" is defined as the mean diameter in a single radial plane.

[Note] 1) "Single mean diameter" is defined as the mean diameter in a single radial plane.

Table 10 Tolerance for metric series thrust needle roller and cage assemblies (type code : FNT)

(1) Bore diameter Unit : mm				(2) Outside diameter Unit : mm			
Nominal bore diameter D_{c1}		Smallest single bore diameter deviation (E11)		Nominal outside diameter D_c		Largest single outside diameter deviation (c12)	
over	up to	upper	lower	over	up to	upper	lower
3	6	+0.095	+0.020	18	30	-0.110	-0.320
6	10	+0.115	+0.025	30	40	-0.120	-0.370
10	18	+0.142	+0.032	40	50	-0.130	-0.380
18	30	+0.170	+0.040	50	65	-0.140	-0.440
30	50	+0.210	+0.050	65	80	-0.150	-0.450
50	80	+0.250	+0.060	80	100	-0.170	-0.520
80	120	+0.292	+0.072	100	120	-0.180	-0.530
120	180	+0.335	+0.085	120	140	-0.200	-0.600
				140	160	-0.210	-0.610
				160	180	-0.230	-0.630
				180	200	-0.240	-0.700

Table 11 Tolerance for metric series thrust needle roller and cage assemblies (type code : AXK)

(1) Bore diameter Unit : mm				(2) Outside diameter Unit : mm			
Nominal bore diameter D_{c1}		Smallest single bore diameter deviation (E12)		Nominal outside diameter D_c		Largest single outside diameter deviation (c13)	
over	up to	upper	lower	over	up to	upper	lower
3	6	+0.140	+0.020	18	30	-0.110	-0.440
6	10	+0.175	+0.025	30	40	-0.120	-0.510
10	18	+0.212	+0.032	40	50	-0.130	-0.520
18	30	+0.250	+0.040	50	65	-0.140	-0.600
30	50	+0.300	+0.050	65	80	-0.150	-0.610
50	80	+0.360	+0.060	80	100	-0.170	-0.710
80	120	+0.422	+0.072	100	120	-0.180	-0.720
120	180	+0.485	+0.085	120	140	-0.200	-0.830
				140	160	-0.210	-0.840
				160	180	-0.230	-0.860
				180	200	-0.240	-0.960

Table 12 Tolerance for metric series thrust washers (type code : AS series)

(1) Bore diameter Unit : mm				(2) Outside diameter Unit : mm			
Nominal bore diameter d		Smallest single bore diameter deviation (E13)		Nominal outside diameter d_1		Largest single outside diameter deviation (e13)	
over	up to	upper	lower	over	up to	upper	lower
3	6	+0.200	+0.020	18	30	-0.040	-0.370
6	10	+0.245	+0.025	30	50	-0.050	-0.440
10	18	+0.302	+0.032	50	80	-0.060	-0.520
18	30	+0.370	+0.040	80	120	-0.072	-0.612
30	50	+0.440	+0.050	120	180	-0.085	-0.715
50	80	+0.520	+0.060	180	250	-0.100	-0.820
80	120	+0.612	+0.072				
120	180	+0.715	+0.085				

Table 13 Tolerance for metric series thrust washers (type code : LS series)

(1) Bore diameter Unit : mm				(2) Outside diameter Unit : mm			
Nominal bore diameter d		Smallest single bore diameter deviation (E12)		Nominal outside diameter d_1		Largest single outside diameter deviation (a12)	
over	up to	upper	lower	over	up to	upper	lower
3	6	+0.140	+0.020	18	30	-0.300	-0.510
6	10	+0.175	+0.025	30	40	-0.310	-0.560
10	18	+0.212	+0.032	40	50	-0.320	-0.570
18	30	+0.250	+0.040	50	65	-0.340	-0.640
30	50	+0.300	+0.050	65	80	-0.360	-0.660
50	80	+0.360	+0.060	80	100	-0.380	-0.730
80	120	+0.422	+0.072	100	120	-0.410	-0.760
120	180	+0.485	+0.085	120	140	-0.460	-0.860
				140	160	-0.520	-0.920
				160	180	-0.580	-0.980
				180	200	-0.660	-1.120

[Remark] Thickness tolerances for series LS heavy thrust washers are given in bearing tables.

Table 14 Tolerance for metric series shaft piloted washers of thrust bearings (type code : WS.811 and WS.812)

Unit : mm

Nominal bore diameter <i>d</i>		Tolerance class P0				Tolerance class P6				Tolerance class P5			
		Deviations Δ_{dmp}		Variation V_{dsp}	$S_i^{(1)}$	Deviations Δ_{dmp}		Variation V_{dsp}	$S_i^{(1)}$	Deviations Δ_{dmp}		Variation V_{dsp}	$S_i^{(1)}$
		upper	lower	max.		min.	upper	lower		max.	min.	upper	
over	up to												
	18	+0	-0.008	0.006	0.010	+0	-0.008	0.006	0.005	+0	-0.008	0.006	0.003
18	30	+0	-0.010	0.008	0.010	+0	-0.010	0.008	0.005	+0	-0.010	0.008	0.003
30	50	+0	-0.012	0.009	0.010	+0	-0.012	0.009	0.006	+0	-0.012	0.009	0.003
50	80	+0	-0.015	0.011	0.010	+0	-0.015	0.011	0.007	+0	-0.015	0.011	0.004
80	120	+0	-0.020	0.015	0.015	+0	-0.020	0.015	0.008	+0	-0.020	0.015	0.004
120	180	+0	-0.025	0.019	0.015	+0	-0.025	0.019	0.009	+0	-0.025	0.019	0.005
180	250	+0	-0.030	0.023	0.020	+0	-0.030	0.023	0.010	+0	-0.030	0.023	0.005
250	315	+0	-0.035	0.026	0.025	+0	-0.035	0.026	0.013	+0	-0.035	0.026	0.007
315	400	+0	-0.040	0.030	0.030	+0	-0.040	0.030	0.015	+0	-0.040	0.030	0.007
400	500	+0	-0.045	0.034	0.030	+0	-0.045	0.034	0.018	+0	-0.045	0.034	0.009

[Note] 1) The values of the wall thickness variation S_{e1} for the housing piloted washer are identical to S_i for the shaft - piloted washers.

Δ_{dmp} : Single plane mean bore diameter deviation

V_{dsp} : Single plane bore diameter variation

S_i : Wall thickness variation

Table 15 Tolerance for metric series housing piloted washers of thrust bearings (type code : GS.811 and GS.812)

Unit : mm

Nominal outside diameter <i>D</i>		Tolerance class P0			Tolerance class P6			Tolerance class P5		
		Deviations Δ_{Dmp}		Variation V_{Dsp}	Deviations Δ_{Dmp}		Variation V_{Dsp}	Deviations Δ_{Dmp}		Variation V_{Dsp}
		upper	lower	max.	upper	lower	max.	upper	lower	max.
over	up to									
	30	+0	-0.013	0.010	+0	-0.013	0.010	+0	-0.013	0.010
30	50	+0	-0.016	0.012	+0	-0.016	0.012	+0	-0.016	0.012
50	80	+0	-0.019	0.014	+0	-0.019	0.014	+0	-0.019	0.014
80	120	+0	-0.022	0.017	+0	-0.022	0.017	+0	-0.022	0.017
120	180	+0	-0.025	0.019	+0	-0.025	0.019	+0	-0.025	0.019
180	250	+0	-0.030	0.023	+0	-0.030	0.023	+0	-0.030	0.023
250	315	+0	-0.035	0.026	+0	-0.035	0.026	+0	-0.035	0.026
315	400	+0	-0.040	0.030	+0	-0.040	0.030	+0	-0.040	0.030
400	500	+0	-0.045	0.034	+0	-0.045	0.034	+0	-0.045	0.034

[Note] Δ_{Dmp} : Single plane mean outside diameter deviation

V_{Dsp} : Single plane outside diameter variation

Table 16 Tolerance for inch series thrust needle roller and cage assemblies (type code : NTA)

Unit : mm

Needle roller diameter (nominal) D_w	Deviations			
	Bore diameter D_{c1}		Outside diameter D_c	
	upper	lower	upper	lower
1.981	+0.178	+0.051	-0.254	-0.508
3.175	+0.254	+0.051	-0.254	-0.635

Table 17 Tolerance for inch series thrust washers (type code : TRA, TRB, etc.)

(1) Bore diameter Unit : mm

Nominal bore diameter <i>d</i>		Deviations	
over	up to	upper	lower
6.000	57.200	+0.300	+0.050
57.200	133.400	+0.430	+0.050

(2) Outside diameter Unit : mm

Nominal Outside diameter d_1		Deviations	
over	up to	upper	lower
6.000	133.400	-0.025	-0.760

Table 18 Tolerance for combined needle roller bearings (thrust component thickness (C_1))

Unit : mm

Bearing series	Tolerance	
	upper	lower
NAXK, NAXK.Z	+0	-0.200
NAXR, NAXR.Z	+0	-0.200
RAXZ	+0.100	-0.110

[Recommended fit and internal clearance]

Table 19 Recommended fit for metric series radial needle roller and cage assemblies

Condition	Tolerance zone class		Housing bore
	Shaft		
Radial clearance	$F_w \leq 50 \text{ mm}$	$F_w > 50 \text{ mm}$	
Smaller than normal	j 5	h 5	G 6
Normal	h 5	g 5	
Larger than normal	g 6	f 6	

Table 20 Recommended fit for metric series drawn cup needle roller bearings

Bearing type	Operating condition	Shaft fit (recommended internal radial clearances)	Housing fit (recommended internal radial clearances)
		HK, BK (caged)	One piece heavy section steel or cast iron housing
	Housing material of low rigidity	h5 (h6)	R6 (R7)
	Outer ring rotation (one piece heavy section steel or cast iron housing)	f5 (f6)	R6 (R7)
	Oscillating Motion	j5 (j6)	¹⁾

[Note] 1) Tolerance dependent on housing design.
 [Remark] When the bearing is provided with an inner ring, the shaft tolerance class h5 should be selected.

Table 23 Recommended fit for metric series needle roller thrust bearings

Bearing components	Shaft tolerance (shaft piloting)	Housing tolerance (housing piloting)
Needle roller and cage assembly. Types : AXK, FNT	h8	H8
Thin thrust washer. Type : AS	h8	H8
Heavy thrust washer. Type : LS	h8	H8
Shaft-piloted thrust washer. Type : WS.811	h6 (j6)	Clearance
Housing-piloted thrust washer. Type : GS.811	Clearance	H7 (K7)

Table 24 Recommended fit for metric series cylindrical roller thrust bearings

Bearing components	Shaft tolerance (shaft piloting)	Housing tolerance (housing piloting)	Piloting components
Thrust cylindrical roller and cage assembly. Types : K.811 and K.812	h8	H10	Shaft
Heavy thrust washer. Type : LS	h10	H11	Shaft
Shaft-piloted thrust washer. Types : WS.811, WS.812	h6 (j6)	Clearance	Shaft
Housing-piloted thrust washer. Types : GS.811, GS.812	Clearance	H7 (K7)	Housing

Table 21 Recommended fit for inch series drawn cup needle roller bearings

Bearing design	Shaft			Housing		
	Classification	max.	min.	Classification	max.	min.
J, JTT ¹⁾	$F_w \leq 5.556 \text{ mm (7/32")}$	0	-0.008 mm (-0.0003")	$D \leq 7.144 \text{ mm (9/32")}$	+0.013 mm (-0.0005")	0
	$5.556 \text{ mm (7/32")} < F_w \leq 50.006 \text{ mm (1 31/32")}$	0	-0.013 mm (-0.0005")			
	$50.006 \text{ mm (1 31/32")} < F_w \leq 119.856 \text{ mm (4 23/32")}$	0	-0.015 mm (-0.0006")	$7.144 \text{ mm (9/32")} < D$	+0.013 mm (-0.0005")	+0.013 mm (-0.0005")
	$119.856 \text{ mm (4 23/32")} < F_w \leq 180.181 \text{ mm (7 3/32")}$	0	-0.018 mm (-0.0007")			

[Note] 1) Special fits
 When $D = 8.733 \text{ mm (0.3438")}$: housing fit : -0.003 mm (-0.0001") maximum, -0.015 mm (-0.0006") minimum
 When $D = 22.212 \text{ mm (0.8745")}$: housing fit : +0.025 mm (+0.0010") maximum, 0 mm (0") minimum
 When $D = 152.400 \text{ mm (6.0000")}$: housing fit : +0.025 mm (+0.0010") maximum, -0.025 mm (-0.0010") minimum

Table 22 Recommended fit for metric series heavy-duty needle roller bearings

Without inner ring

Rotation conditions	Nominal housing bore diameter D (mm)	ISO tolerance zone for housing		Nominal shaft diameter F' shaft (mm)	ISO tolerance zone for shaft	
		caged	full		caged	full
Load stationary relative to housing	all diameters	H7 (J7)	J6	all diameters	h6 (h5)	h5
General work with larger clearance		K7	—		g6	—
Load rotates relative to housing		N7	M6		f6	g5

[Remark] Care should be taken that the selected bearing internal clearance is appropriate for the operating conditions.



[Shaft and housing specifications]

Table 25 Specifications of shafts and housings (needle roller and cage assemblies, drawn cup needle roller bearings, and heavy-duty needle roller bearings)

	Shaft		Housing bore	
	Raceway surface	Fitting surface	Raceway surface	Fitting surface
Roundness	· Shaft diameter ≤ 25 mm : 2.5 μm or less · Shaft diameter > 25 mm : 2.5 $\mu\text{m} \times$ (shaft diameter /25 mm) or less	One-half the shaft diameter tolerance or less	8 μm or one-half the bore tolerance or less	One-half the bore tolerance or less
Variation of mean diameter (Cylindricity)	Within the range of the bearing width, 5 μm or less per 25 mm or one-half the bearing tolerance or less (whichever is smaller)	One-half the shaft diameter tolerance or less	Within the range of the bearing width, 5 μm or less per 25 mm or one-half the bearing tolerance or less (whichever is smaller)	Within the length of the outer ring, 13 μm or one-half the diameter tolerance (whichever is smaller) or less
Surface roughness	0.2 a or less	0.8 a or less	0.2 a or less	1.6 a or less
Hardness	58 HRC or harder ¹⁾	—	58 HRC or harder ¹⁾	—
Shaft slope	13 μm or less per 25 mm		—	

[Note] 1) During the carburizing or induction-hardening of case hardened steel, not only must the surface hardness requirement specified above be met, but the case depth of HV 550 (52.3 HRC) must be met in the range of 0.08 D_w to 0.10 D_w mm. (D_w : roller diameter)

Table 26 Needle roller thrust bearing mounting surface specifications

Flatness (dishing or coning)		Maximum angle : Arctan 0.001
Squareness		Maximum angle : Arctan 0.0005
Roughness (Ra)		0.2 a or less
Hardness		58 HRC or harder (refer to the note for Table 25 above regarding depth.)

Radial needle roller and cage assemblies
single-row, double-row assemblies
metric series
K, K ZW series

Shaft dia. 3 ~ (10) mm

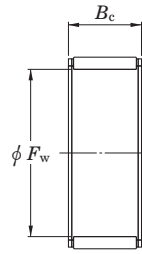

K

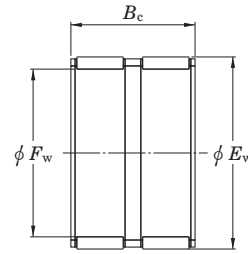

K ZW

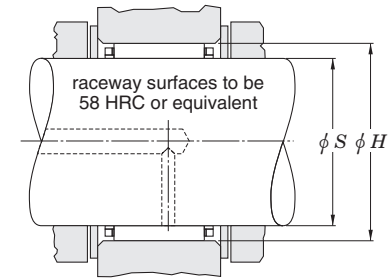

Boundary dimensions (mm)				Bearing No.	Basic load ratings (kN)		Fatigue load limit (kN) C _u	Cage material ¹⁾ P / S	Limiting speeds (min ⁻¹)		(Refer.) Mass (kg)	Recommended dimensions (mm)			
Shaft dia.	F _w	E _w	B _c -0.20 -0.55		C _r	C _{0r}			Grease lub.	Oil lub.		S (Shaft)		H (Housing)	
									max.	min.	max.	min.			
3	3	5	7	K3X5X7TN	1.56	1.29	0.200	P	48 000	74 000	0.0002	3.000	2.996	5.004	5.012
4	4	7	7	K4X7X7TN	1.83	1.32	0.200	P	34 000	52 000	0.0005	4.000	3.995	7.014	7.005
5	5	8	8	K5X8X8TN	2.18	1.71	0.260	P	31 000	47 000	0.0007	5.000	4.995	8.014	8.005
	5	8	10	K5X8X10TN	3.04	2.63	0.400	P	31 000	47 000	0.0008	5.000	4.995	8.014	8.005
	5	9	13	K5X9X13TN	4.29	3.55	0.540	P	26 000	40 000	0.002	5.000	4.995	9.014	9.005
6	6	9	8	K6X9X8H	3.19	2.90	0.420	S	29 000	44 000	0.0008	6.000	5.995	9.014	9.005
	6	9	8	K6X9X8TN	2.47	2.07	0.310	P	29 000	44 000	0.001	6.000	5.995	9.014	9.005
	6	9	10	K6X9X10TN	3.07	2.74	0.420	P	29 000	44 000	0.001	6.000	5.995	9.014	9.005
7	7	10	8	K7X10X8TN	2.74	2.44	0.370	P	28 000	42 000	0.001	7.000	6.994	10.014	10.005
	7	10	10	K7X10X10TN	3.40	3.22	0.490	P	28 000	42 000	0.001	7.000	6.994	10.014	10.005
	7	11	15	K7X11X15TN	6.44	6.24	0.940	P	23 000	35 000	0.003	7.000	6.994	11.017	11.006
8	8	11	8	K8X11X8FV	3.23	3.11	0.470	S	26 000	41 000	0.002	8.000	7.994	11.017	11.006
	8	11	8	K8X11X8TN	2.34	2.05	0.300	P	26 000	41 000	0.001	8.000	7.994	11.017	11.006
	8	11	10	K8X11X10H	4.57	4.89	0.740	S	26 000	41 000	0.002	8.000	7.994	11.017	11.006
	8	11	10	K8X11X10FV	4.01	4.11	0.630	S	26 000	41 000	0.002	8.000	7.994	11.017	11.006
	8	11	10	K8x11x10TN	3.84	3.91	0.600	P	26 000	41 000	0.001	8.000	7.994	11.006	11.017
	8	11	13	K8x11x13TN	5.18	5.75	0.870	P	26 000	41 000	0.002	8.000	7.994	11.006	11.017
	8	11	13	K8X11X13H	5.22	5.78	0.880	S	26 000	41 000	0.003	8.000	7.994	11.017	11.006
	9	9	12	10	K9X12X10FH	4.27	4.60	0.700	S	26 000	40 000	0.003	9.000	8.994	12.017
9	9	12	10	K9X12X10FV	4.27	4.60	0.700	S	26 000	40 000	0.002	9.000	8.994	12.017	12.006
	9	12	13	K9X12X13FH	5.57	6.47	0.980	S	26 000	40 000	0.003	9.000	8.994	12.017	12.006
9	9	12	13	K9X12X13FV	5.57	6.47	0.980	S	26 000	40 000	0.003	9.000	8.994	12.017	12.006
	9	13	8	K9X13X8H	3.96	3.50	0.530	S	21 000	32 000	0.003	9.000	8.994	13.017	13.006
10	10	13	10	K10X13X10H	5.40	6.43	0.980	S	25 000	39 000	0.002	10.000	9.994	13.017	13.006
	10	13	10	K10X13X10TN	4.29	4.77	0.730	P	25 000	39 000	0.002	10.000	9.994	13.017	13.006
	10	13	13	K10X13X13	5.90	7.16	1.10	S	25 000	39 000	0.003	10.000	9.994	13.017	13.006

[Note] 1) Cage material: P: polymer cage, S: steel cage

Radial needle roller and cage assemblies
single-row, double-row assemblies
metric series
K, K ZW series

Shaft dia. (10) ~ (15) mm

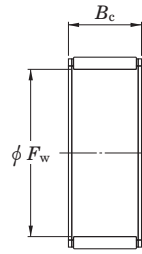

K

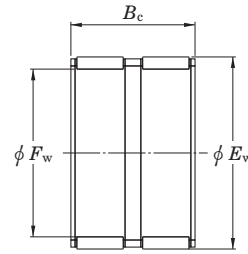

K ZW

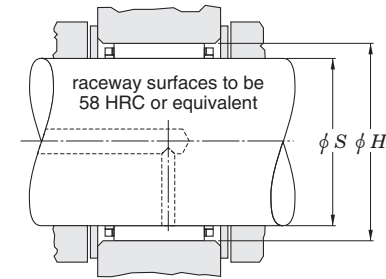

Shaft dia.	Boundary dimensions (mm)			Bearing No.	Basic load ratings (kN)		Fatigue load limit (kN) C _u	Cage material ¹⁾ P / S	Limiting speeds (min ⁻¹)		(Refer.) Mass (kg)	Recommended dimensions (mm)			
	F _w	E _w	B _c -0.20 -0.55		C _r	C _{0r}			Grease lub.	Oil lub.		S (Shaft)		H (Housing)	
												max.	min.	max.	min.
10	10	13	16	K10X13X16	7.43	9.64	1.50	S	25 000	39 000	0.004	10.000	9.994	13.017	13.006
	10	14	10	K10X14X10H	6.12	6.29	0.960	S	20 000	31 000	0.003	10.000	9.994	14.017	14.006
	10	14	13	K10X14X13H	7.88	8.71	1.35	S	20 000	31 000	0.004	10.000	9.994	14.017	14.006
	10	16	12	K10X16X12F	8.39	7.47	1.15	S	15 000	24 000	0.006	10.000	9.994	16.017	16.006
	10	16	12	K10X16X12TN	7.50	6.40	0.970	P	15 000	24 000	0.005	10.000	9.994	16.017	16.006
12	12	15	10	K12X15X10H	5.85	7.51	1.15	S	24 000	37 000	0.003	12.000	11.992	15.017	15.006
	12	15	13	K12X15X13H	6.78	9.03	1.40	S	24 000	37 000	0.004	12.000	11.992	15.017	15.006
	12	16	13	K12X16X13H	7.49	8.51	1.60	S	19 000	30 000	0.006	12.000	11.992	16.017	16.006
	12	17	13	K12X17X13	8.93	9.29	1.20	S	16 000	25 000	0.008	12.000	11.992	17.017	17.006
	12	18	12	K12X18X12H	9.76	9.40	1.40	S	14 000	22 000	0.009	12.000	11.992	18.017	18.006
13	13	17	10	K13X17X10	7.22	8.33	1.25	S	19 000	29 000	0.004	13.000	12.992	17.017	17.006
	13	18	15	K13X18X15F	10.8	12.1	1.85	S	16 000	25 000	0.008	13.000	12.992	18.017	18.006
14	14	18	8	K14X18X8	5.39	5.82	0.880	S	19 000	29 000	0.004	14.000	13.992	18.017	18.006
	14	18	10	K14X18X10	7.17	8.41	1.30	S	19 000	29 000	0.005	14.000	13.992	18.017	18.006
	14	18	13	K14X18X13	9.73	12.5	1.90	S	19 000	29 000	0.006	14.000	13.992	18.017	18.006
	14	18	15	K14X18X15	10.5	13.8	2.15	S	19 000	29 000	0.007	14.000	13.992	18.017	18.006
	14	18	17	K14X18X17H	12.4	17.1	2.65	S	19 000	29 000	0.008	14.000	13.992	18.017	18.006
	14	19	13	K14X19X13H	10.2	11.4	1.75	S	16 000	24 000	0.008	14.000	13.992	19.020	19.007
	14	19	18	K14X19X18F	13.2	16.0	2.50	S	16 000	24 000	0.011	14.000	13.992	19.020	19.007
	14	20	12	K14X20X12	10.5	10.6	1.60	S	14 000	21 000	0.009	14.000	13.992	20.020	20.007
15	15	18	14	K15X18X14TN	7.92	11.9	1.80	P	13 000	23 000	0.003	15.000	14.992	18.017	18.006
	15	18	16	K15X18X16F	8.36	12.6	1.95	S	13 000	23 000	0.005	15.000	14.992	18.017	18.006
	15	18	17	K15X18X17	8.08	12.1	1.85	S	23 000	36 000	0.005	15.000	14.992	18.017	18.006
	15	19	10	K15X19X10	7.87	9.69	1.45	S	18 000	28 000	0.005	15.000	14.992	19.020	19.007
	15	19	13	K15X19X13	9.66	12.6	1.90	S	18 000	28 000	0.007	15.000	14.992	19.020	19.007
	15	19	17	K15X19X17H	12.3	17.2	2.65	S	18 000	28 000	0.009	15.000	14.992	19.020	19.007
	15	19	22	K15X19X22ZW	12.2	17.0	2.60	S	18 000	28 000	0.010	15.000	14.992	19.020	19.007

[Note] 1) Cage material: P: polymer cage, S: steel cage

Radial needle roller and cage assemblies
single-row, double-row assemblies
metric series
K, K ZW series

Shaft dia. (15) ~ (18) mm

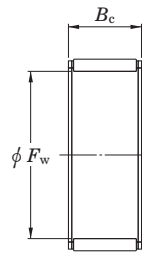

K

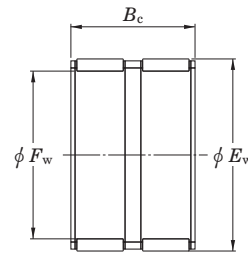

K ZW

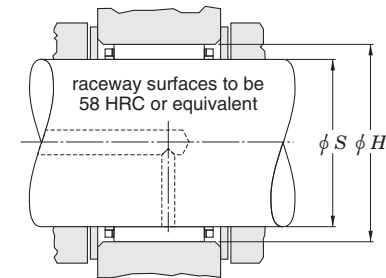

Shaft dia.	Boundary dimensions (mm)			Bearing No.	Basic load ratings (kN)		Fatigue load limit (kN) C _u	Cage material ¹⁾ P / S	Limiting speeds (min ⁻¹)		(Refer.) Mass (kg)	Recommended dimensions (mm)			
	F _w	E _w	B _c -0.20 -0.55		C _r	C _{0r}			Grease lub.	Oil lub.		S (Shaft)		H (Housing)	
												max.	min.	max.	min.
15	15	20	13	K15X20X13H	9.93	11.3	1.80	S	16 000	24 000	0.008	15.000	14.992	20.020	20.007
	15	21	15	K15X21X15	13.4	14.8	2.30	S	14 000	21 000	0.013	15.000	14.992	21.020	21.007
	15	21	21	K15X21X21H	18.0	21.7	3.40	S	14 000	21 000	0.018	15.000	14.992	21.020	21.007
16	16	20	8	K16X20X8F	6.37	7.51	1.15	S	18 000	28 000	0.005	16.000	15.992	20.020	20.007
	16	20	10	K16X20X10H	7.82	9.76	1.50	S	18 000	28 000	0.006	16.000	15.992	20.020	20.007
	16	20	13	K16X20X13	10.1	13.5	2.05	S	18 000	28 000	0.007	16.000	15.992	20.020	20.007
	16	20	14	K16X20X14	10.8	14.8	2.25	S	18 000	28 000	0.007	16.000	15.992	20.020	20.007
	16	20	17	K16X20X17H	12.9	18.5	2.85	S	18 000	28 000	0.008	16.000	15.992	20.020	20.007
	16	20	20	K16X20X20	13.4	19.5	3.05	S	18 000	28 000	0.011	16.000	15.992	20.020	20.007
	16	22	12	K16X22X12	11.2	11.9	1.80	S	19 000	29 000	0.010	16.000	15.992	22.020	22.007
	16	22	16	K16X22X16H	14.9	17.2	2.70	S	19 000	29 000	0.014	16.000	15.992	22.020	22.007
	16	22	20	K16X22X20	18.6	22.9	3.60	S	19 000	29 000	0.017	16.000	15.992	22.020	22.007
17	16	24	20	K16X24X20	20.2	21.4	3.45	S	20 000	30 000	0.025	16.000	15.992	24.020	24.007
	17	20	10	K17X20X10	5.96	8.53	1.30	S	16 000	25 000	0.004	17.000	16.992	20.020	20.007
	17	21	10	K17X21X10	8.12	10.4	1.60	S	17 000	26 000	0.006	17.000	16.992	21.020	21.007
	17	21	12.8	K17X21X13H	10.5	14.5	2.20	S	17 000	26 000	0.008	17.000	16.992	21.020	21.007
	17	21	15	K17X21X15	11.4	16.1	2.50	S	17 000	26 000	0.008	17.000	16.992	21.020	21.007
	17	21	17	K17X21X17H	13.4	19.8	3.05	S	17 000	26 000	0.011	17.000	16.992	21.020	21.007
	17	22	20	K17X22X20FH	17.0	23.3	3.65	S	17 000	27 000	0.015	17.000	16.992	22.020	22.007
	17	23	15	K17X23X15F	14.1	16.3	2.55	S	18 000	27 000	0.010	17.000	16.992	23.020	23.007
18	18	22	8	K18X22X8F	6.32	7.70	1.15	S	16 000	24 000	0.005	18.000	17.992	22.020	22.007
	18	22	10	K18X22X10H	8.41	11.1	1.70	S	16 000	24 000	0.006	18.000	17.992	22.020	22.007
	18	22	13	K18X22X13H	10.8	15.4	2.35	S	16 000	24 000	0.008	18.000	17.992	22.020	22.007
	18	22	14	K18X22X14	11.6	16.8	2.55	S	16 000	24 000	0.009	18.000	17.992	22.020	22.007
	18	22	14	K18X22X14FV	11.3	16.3	2.45	S	16 000	24 000	0.009	18.000	17.992	22.020	22.007
	18	22	17	K18X22X17H	13.3	19.9	3.10	S	16 000	24 000	0.009	18.000	17.992	22.020	22.007
	18	22	20	K18X22X20F	15.0	23.4	3.65	S	16 000	24 000	0.011	18.000	17.992	22.020	22.007
	18	24	12	K18X24X12	11.8	13.1	1.95	S	17 000	25 000	0.011	18.000	17.992	24.020	24.007

[Note] 1) Cage material: P: polymer cage, S: steel cage

Radial needle roller and cage assemblies
single-row, double-row assemblies
metric series
K, K ZW series

Shaft dia. (18) ~ (22) mm

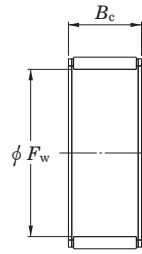

K

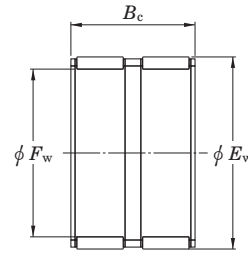

K ZW

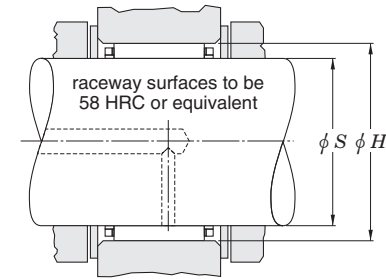

Shaft dia.	Boundary dimensions (mm)			Bearing No.	Basic load ratings (kN)		Fatigue load limit (kN) C _u	Cage material ¹⁾ P / S	Limiting speeds (min ⁻¹)		(Refer.) Mass (kg)	Recommended dimensions (mm)			
	F _w	E _w	B _c -0.20 -0.55		C _r	C _{0r}			Grease lub.	Oil lub.		S (Shaft)		H (Housing)	
												max.	min.	max.	min.
18	18	24	20	K18X24X20H	19.4	24.9	3.90	S	16 000	25 000	0.019	18.000	17.992	24.020	24.007
	18	25	22	K18X25X22H	23.3	28.6	4.50	S	17 000	26 000	0.025	18.000	17.992	25.020	25.007
	18	26	12	K18X26X12FV	13.8	13.5	2.10	S	11 000	17 000	0.020	18.000	17.992	26.020	26.007
	18	26	20	K18X26X20F	21.7	24.1	3.85	S	17 000	26 000	0.027	18.000	17.992	26.020	26.007
19	19	23	13	K19X23X13	10.8	15.5	2.35	S	15 000	23 000	0.008	19.000	18.991	23.020	23.007
	19	23	17	K19X23X17	13.4	20.6	3.20	S	15 000	23 000	0.011	19.000	18.991	23.020	23.007
20	20	24	8	K20X24X8F	7.31	9.60	1.50	S	14 000	22 000	0.005	20.000	19.991	24.020	24.007
	20	24	10	K20X24X10H	8.97	12.5	2.05	S	14 000	22 000	0.006	20.000	19.991	24.020	24.007
	20	24	12	K20X24X12	10.7	15.7	2.40	S	14 000	22 000	0.008	20.000	19.991	24.020	24.007
	20	24	13	K20X24X13H	11.5	17.3	1.30	S	14 000	22 000	0.009	20.000	19.991	24.020	24.007
	20	24	14	K20X24X14	12.4	18.9	2.85	S	14 000	22 000	0.009	20.000	19.991	24.020	24.007
	20	24	17	K20X24X17H	14.8	23.7	3.65	S	14 000	22 000	0.011	20.000	19.991	24.020	24.007
	20	26	12	K20X26X12	13.0	15.3	2.30	S	15 000	23 000	0.012	20.000	19.991	26.020	26.007
	20	26	13	K20X26X13H	13.4	15.9	2.35	S	15 000	23 000	0.014	20.000	19.991	26.020	26.007
	20	26	17	K20X26X17H	19.3	25.5	4.00	S	15 000	23 000	0.017	20.000	19.991	26.020	26.007
	20	26	20	K20X26X20	20.3	27.2	4.25	S	15 000	23 000	0.020	20.000	19.991	26.020	26.007
	20	28	20	K20X28X20H	24.6	29.0	2.70	S	15 000	23 000	0.028	20.000	19.991	28.020	28.007
	20	28	25	K20X28X25H	29.7	37.0	5.80	S	15 000	23 000	0.036	20.000	19.991	28.020	28.007
	20	30	30	K20X30X30H	38.9	45.8	7.20	S	16 000	24 000	0.055	20.000	19.991	30.020	30.007
	20	32	36	K20X32X36H	49.9	57.0	9.15	S	16 000	25 000	0.082	20.000	19.991	32.025	32.009
21	21	25	17	K21X25X17H	14.3	23.1	3.60	S	14 000	21 000	0.013	21.000	20.991	25.020	25.007
22	22	26	10	K22X26X10H	9.81	14.5	2.20	S	13 000	20 000	0.007	22.000	21.991	26.020	26.007
	22	26	13	K22X26X13H	11.8	18.3	2.95	S	13 000	20 000	0.012	22.000	21.991	26.020	26.007
	22	26	17	K22X26X17H	15.6	26.3	4.05	S	13 000	20 000	0.012	22.000	21.991	26.020	26.007
	22	26	18	K22X26X18H	15.3	25.5	4.00	S	13 000	20 000	0.017	22.000	21.991	26.020	26.007
	22	28	13	K22X28X13	13.9	17.1	2.60	S	13 000	20 000	0.015	22.000	21.991	28.020	28.007
	22	28	17	K22X28X17H	18.2	24.2	3.80	S	13 000	20 000	0.020	22.000	21.991	28.020	28.007

[Note] 1) Cage material: P: polymer cage, S: steel cage

Radial needle roller and cage assemblies
single-row, double-row assemblies
metric series
K, K ZW series

Shaft dia. (22) ~ (25) mm

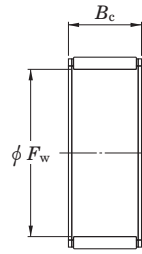

K

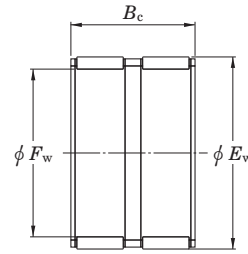

K ZW

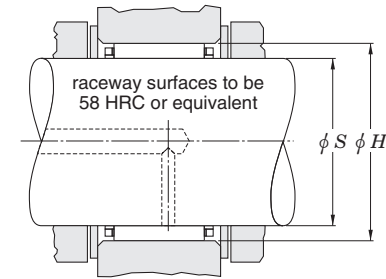

Shaft dia.	Boundary dimensions (mm)			Bearing No.	Basic load ratings (kN)		Fatigue load limit (kN) C _u	Cage material ¹⁾ P / S	Limiting speeds (min ⁻¹)		(Refer.) Mass (kg)	Recommended dimensions (mm)			
	F _w	E _w	B _c -0.20 -0.55		C _r	C _{0r}			Grease lub.	Oil lub.		S (Shaft)		H (Housing)	
												max.	min.	max.	min.
22	22	30	15	K22X30X15H	19.7	22.3	3.45	S	14 000	21 000	0.023	22.000	21.991	30.020	30.007
	22	30	20	K22X30X20FV	24.4	29.4	4.70	S	14 000	21 000	0.031	22.000	21.991	30.020	30.007
	22	32	24	K22X32X24F	33.1	37.9	6.05	S	14 000	22 000	0.046	22.000	21.991	32.025	32.009
	22	32	30	K22X32X30H	41.8	51.3	8.05	S	14 000	22 000	0.057	22.000	21.991	32.025	32.009
23	23	28	24	K23X28X24F	22.4	36.2	5.70	S	12 000	19 000	0.023	23.000	22.991	28.020	28.007
	23	35	16	K23X35X16H	25.9	25.1	3.90	S	14 000	21 000	0.040	23.000	22.991	35.025	35.009
24	24	28	10	K24X28X10H	9.67	14.6	2.20	S	12 000	18 000	0.027	24.000	23.991	28.020	28.007
	24	28	13	K24X28X13H	12.5	20.2	3.05	S	12 000	18 000	0.010	24.000	23.991	28.020	28.007
	24	28	16	K24X28X16F	12.6	20.4	3.10	S	12 000	18 000	0.012	24.000	23.991	28.020	28.007
	24	28	17	K24X28X17H	15.4	26.4	4.10	S	12 000	18 000	0.013	24.000	23.991	28.020	28.007
	24	30	10	K24X30X10TN	11.3	13.5	2.05	P	12 000	19 000	0.008	24.000	23.991	30.020	30.007
	24	30	17	K24X30X17H	19.8	27.7	4.35	S	12 000	19 000	0.020	24.000	23.991	30.020	30.007
	24	30	22	K24X30X22	25.0	37.3	5.80	S	12 000	19 000	0.024	24.000	23.991	30.020	30.007
	24	36	23	K24X36X23H	37.1	40.1	6.40	S	13 000	20 000	0.070	24.000	23.991	36.025	36.009
25	25	29	10	K25X29X10H	9.61	14.6	2.25	S	11 000	17 000	0.008	25.000	24.991	29.020	29.007
	25	29	13	K25X29X13H	12.8	21.1	3.20	S	11 000	17 000	0.010	25.000	24.991	29.020	29.007
	25	29	17	K25X29X17H	15.1	26.2	4.10	S	11 000	17 000	0.016	25.000	24.991	29.020	29.007
	25	30	13	K25X30X13	14.6	21.4	3.25	S	11 000	17 000	0.012	25.000	24.991	30.020	30.007
	25	30	17	K25X30X17H	18.8	29.8	4.60	S	11 000	17 000	0.016	25.000	24.991	30.020	30.007
	25	30	18	K25X30X18	20.6	33.4	5.30	S	11 000	17 000	0.017	25.000	24.991	30.020	30.007
	25	30	20	K25X30X20H	21.9	36.1	5.65	S	11 000	17 000	0.019	25.000	24.991	30.020	30.007
	25	30	24	K25X30X24H	24.8	42.4	6.60	S	11 000	17 000	0.024	25.000	24.991	30.020	30.007
	25	30	26	K25X30X26ZW	23.0	38.6	5.90	S	11 000	17 000	0.027	25.000	24.991	30.020	30.007
	25	31	14	K25X31X14H	16.8	22.7	3.45	S	12 000	18 000	0.017	25.000	24.991	31.025	31.009
	25	31	17	K25X31X17H	19.7	27.8	4.35	S	12 000	18 000	0.020	25.000	24.991	31.025	31.009
	25	31	21	K25X31X21H	25.1	38.0	5.95	S	12 000	18 000	0.026	25.000	24.991	31.025	31.009
	25	31	24	K25X31X24FH	25.3	38.5	6.05	S	12 000	18 000	0.031	25.000	24.991	31.025	31.009
	25	32	16	K25X32X16	19.8	25.3	4.00	S	12 000	18 000	0.027	25.000	24.991	32.025	32.009

[Note] 1) Cage material: P: polymer cage, S: steel cage

Radial needle roller and cage assemblies
single-row, double-row assemblies
metric series
K, K ZW series

Shaft dia. (25) ~ 29 mm

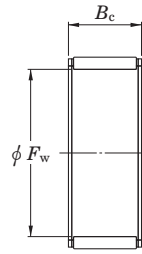

K

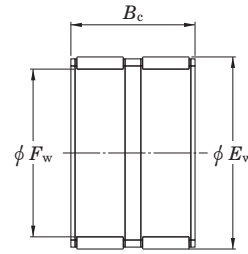

K ZW

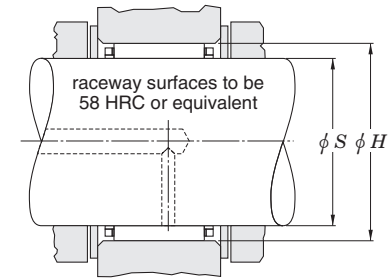

Shaft dia.	Boundary dimensions (mm)			Bearing No.	Basic load ratings (kN)		Fatigue load limit (kN) C _u	Cage material ¹⁾ P / S	Limiting speeds (min ⁻¹)		(Refer.) Mass (kg)	Recommended dimensions (mm)			
	F _w	E _w	B _c -0.20 -0.55		C _r	C _{0r}			Grease lub.	Oil lub.		S (Shaft)		H (Housing)	
												max.	min.	max.	min.
25	25	33	20	K25X33X20H	28.8	37.6	5.95	S	12 000	18 000	0.035	25.000	24.991	33.025	33.009
	25	33	24	K25X33X24H	32.3	43.5	6.85	S	12 000	18 000	0.038	25.000	24.991	33.025	33.009
	25	33	25	K25X33X25H	33.0	44.6	7.00	S	12 000	18 000	0.041	25.000	24.991	33.025	33.009
	25	35	23.7	K25X35X23,7H	35.9	42.3	6.90	S	12 000	19 000	0.050	25.000	24.991	35.025	35.009
	25	35	25	K25X35X25H	37.8	46.2	7.25	S	12 000	19 000	0.054	25.000	24.991	35.025	35.009
	25	35	30	K25X35X30H	44.6	57.2	9.00	S	12 000	19 000	0.060	25.000	24.991	35.025	35.009
	25	35	36	K25X35X36H	52.4	70.4	11.0	S	12 000	19 000	0.074	25.000	24.991	35.025	35.009
	25	37	20	K25X37X20H	32.5	34.1	5.45	S	12 000	19 000	0.055	25.000	24.991	37.025	37.009
26	26	30	10	K26X30X10F	9.46	14.5	2.20	S	11 000	16 000	0.007	26.000	25.991	30.020	30.007
	26	30	13	K26X30X13	12.3	20.4	3.10	S	10 000	16 000	0.011	26.000	25.991	30.020	30.007
	26	30	17	K26X30X17	15.0	26.3	3.10	S	10 000	16 000	0.014	26.000	25.991	30.020	30.007
	26	30	22	K26X30X22ZW	16.7	30.2	4.60	S	10 000	16 000	0.018	26.000	25.991	30.020	30.007
28	28	32	21	K28X32X21F	18.7	35.7	5.55	S	9 900	15 000	0.018	28.000	27.991	32.025	32.009
	28	33	13	K28X33X13F	14.1	21.4	3.25	S	10 000	15 000	0.015	28.000	27.991	33.025	33.009
	28	33	17	K28X33X17H	19.8	33.0	5.10	S	10 000	15 000	0.018	28.000	27.991	33.025	33.009
	28	33	27	K28X33X27	29.0	53.8	8.30	S	10 000	15 000	0.027	28.000	27.991	33.025	33.009
	28	34	17	K28X34X17	21.1	31.5	6.30	S	10 000	16 000	0.022	28.000	27.991	34.025	34.009
	28	34	20	K28X34X20H	24.4	37.8	7.65	S	10 000	16 000	0.025	28.000	27.991	34.025	34.009
	28	35	15	K28X35X15H	19.5	25.6	3.95	S	10 000	16 000	0.025	28.000	27.991	35.025	35.009
	28	35	16	K28X35X16H	21.5	29.1	4.60	S	10 000	16 000	0.026	28.000	27.991	35.025	35.009
	28	35	27	K28X35X27H	35.2	54.7	8.50	S	10 000	16 000	0.042	28.000	27.991	35.025	35.009
	28	36	20	K28X36X20FV	27.8	37.0	5.95	S	10 000	16 000	0.039	28.000	27.991	36.025	36.009
	28	38	25	K28X38X25,5	40.9	52.7	8.25	S	11 000	16 000	0.059	28.000	27.991	38.025	38.009
	28	40	18	K28X40X18H	33.6	36.5	5.90	S	11 000	17 000	0.060	28.000	27.991	40.025	40.009
	28	40	25	K28X40X25H	45.5	54.0	8.55	S	11 000	17 000	0.072	28.000	27.991	40.025	40.009
	28	40	30	K28X40X30H	54.3	67.8	10.7	S	11 000	17 000	0.100	28.000	27.991	40.025	40.009
28	41	25	K28X41X25H	49.2	57.1	9.05	S	11 000	17 000	0.082	28.000	27.991	41.025	41.009	
29	29	34	27	K29X34X27F	28.9	54.0	8.40	S	9 700	15 000	0.033	29.000	28.991	34.025	34.009

[Note] 1) Cage material: P: polymer cage, S: steel cage

Radial needle roller and cage assemblies
single-row, double-row assemblies
metric series
K, K ZW series

Shaft dia. 30 ~ (34) mm

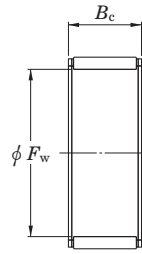

K

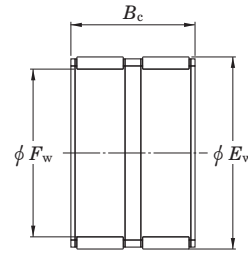

K ZW

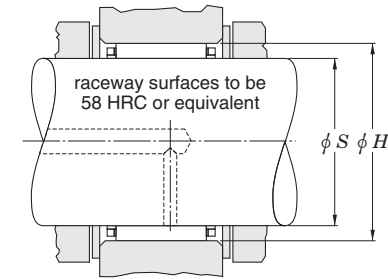

Shaft dia.	Boundary dimensions (mm)			Bearing No.	Basic load ratings (kN)		Fatigue load limit (kN) C _u	Cage material ¹⁾ P / S	Limiting speeds (min ⁻¹)		(Refer.) Mass (kg)	Recommended dimensions (mm)			
	F _w	E _w	B _c -0.20 -0.55		C _r	C _{0r}			Grease lub.	Oil lub.		S (Shaft)		H (Housing)	
												max.	min.	max.	min.
30	30	34	13	K30X34X13	13.5	24.1	3.65	S	9 200	14 000	0.011	30.000	29.991	34.025	34.009
	30	35	13	K30X35X13H	15.6	24.9	3.80	S	9 300	14 000	0.017	30.000	29.991	35.025	35.009
	30	35	17	K30X35X17H	20.2	34.6	5.35	S	9 300	14 000	0.022	30.000	29.991	35.025	35.009
	30	35	20	K30X35X20H	23.5	41.9	6.55	S	9 300	14 000	0.023	30.000	29.991	35.025	35.009
	30	35	22.8	K30X35X23F	25.6	46.8	7.40	S	9 300	14 000	0.028	30.000	29.991	35.025	35.009
	30	35	27	K30X35X27H	30.6	59.0	9.10	S	9 300	14 000	0.032	30.000	29.991	35.025	35.009
	30	35	27	K30X35X27HZW	19.9	33.6	5.10	S	9 300	14 000	0.033	30.000	29.991	35.025	35.009
	30	36	14	K30X36X14	18.0	26.2	4.00	S	9 500	15 000	0.020	30.000	29.991	36.025	36.009
	30	37	17.8	K30X37X18	24.3	34.8	6.00	S	9 600	15 000	0.033	30.000	29.991	37.025	37.009
	30	40	30	K30X40X30H	49.2	67.8	10.6	S	9 900	15 000	0.077	30.000	29.991	40.025	40.009
	30	42	30	K30X42X30H	54.2	68.6	10.8	S	10 000	16 000	0.096	30.000	29.991	42.025	42.009
	30	44	26	K30X44X26H	52.4	59.9	9.55	S	10 000	16 000	0.095	30.000	29.991	44.025	44.009
32	32	36	15	K32X36X15F	11.6	20.2	3.10	S	8 600	13 000	0.015	32.000	31.989	36.025	36.009
	32	37	13	K32X37X13	15.2	24.4	4.00	S	8 700	13 000	0.018	32.000	31.989	37.025	37.009
	32	37	17	K32X37X17H	20.0	34.8	5.40	S	8 700	13 000	0.020	32.000	31.989	37.025	37.009
	32	37	27	K32X37X27	29.3	56.8	8.85	S	8 700	13 000	0.035	32.000	31.989	37.025	37.009
	32	38	20	K32X38X20H	27.3	45.7	7.15	S	8 800	14 000	0.030	32.000	31.989	38.025	38.009
	32	38	26	K32X38X26H	33.2	58.8	9.15	S	8 800	14 000	0.037	32.000	31.989	38.025	38.009
	32	39	16	K32X39X16H	23.0	33.0	5.20	S	8 900	14 000	0.030	32.000	31.989	39.025	39.009
	32	39	18	K32X39X18H	25.8	38.2	6.05	S	8 900	14 000	0.033	32.000	31.989	39.025	39.009
	32	40	25	K32X40X25H	37.9	57.2	8.90	S	9 000	14 000	0.052	32.000	31.989	40.025	40.009
	32	40	36	K32X40X36H	52.3	86.4	13.6	S	9 000	14 000	0.080	32.000	31.989	40.025	40.009
	32	42	42	K32X42X42H	69.2	108	17.1	S	9 200	14 000	0.110	32.000	31.989	42.025	42.009
	32	46	18	K32X46X18H	39.2	41.9	6.80	S	9 600	15 000	0.075	32.000	31.989	46.025	46.009
	32	46	32	K32X46X32H	67.0	83.4	13.1	S	9 600	15 000	0.140	32.000	31.989	46.025	46.009
	32	46	40	K32X46X40H	81.7	108	12.2	S	9 600	15 000	0.158	32.000	31.989	46.025	46.009
	33	33	51	23	K33X51X23H	55.9	57.6	9.35	S	9 600	15 000	0.140	33.000	32.989	51.029
34	34	38	11	K34X38X11	12.2	21.9	3.35	S	8 100	12 000	0.011	34.000	33.989	38.025	38.009

[Note] 1) Cage material: P: polymer cage, S: steel cage

Radial needle roller and cage assemblies
single-row, double-row assemblies
metric series
K, K ZW series

Shaft dia. (34) ~ (38) mm

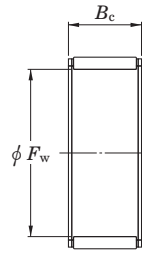

K

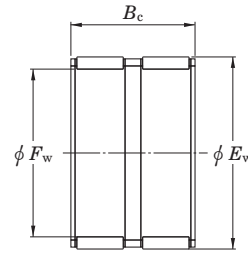

K ZW

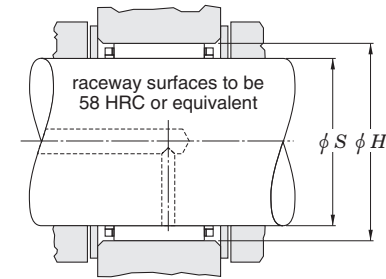

Shaft dia.	Boundary dimensions (mm)			Bearing No.	Basic load ratings (kN)		Fatigue load limit (kN) C _u	Cage material ¹⁾ P / S	Limiting speeds (min ⁻¹)		(Refer.) Mass (kg)	Recommended dimensions (mm)			
	F _w	E _w	B _c -0.20 -0.55		C _r	C _{0r}			Grease lub.	Oil lub.		S (Shaft)		H (Housing)	
												max.	min.	max.	min.
34	34	44	26	K34X44X26FH	42.9	58.9	9.40	S	8 600	13 000	0.080	34.000	33.989	44.025	44.009
35	35	40	13	K35X40X13H	16.2	27.2	4.15	S	7 900	12 000	0.018	35.000	34.989	40.025	40.009
	35	40	17	K35X40X17H	22.1	40.8	6.35	S	7 900	12 000	0.025	35.000	34.989	40.025	40.009
	35	40	19	K35X40X19H	23.2	43.2	6.80	S	7 900	12 000	0.025	35.000	34.989	40.025	40.009
	35	40	25	K35X40X25H	28.4	56.2	8.70	S	7 900	12 000	0.035	35.000	34.989	40.025	40.009
	35	40	27	K35X40X27H	29.8	59.6	9.20	S	7 900	12 000	0.037	35.000	34.989	40.025	40.009
	35	42	16	K35X42X16AH	24.5	36.8	5.80	S	8 100	12 000	0.031	35.000	34.989	42.025	42.009
	35	42	18	K35X42X18	27.5	42.6	6.75	S	8 100	12 000	0.035	35.000	34.989	42.025	42.009
	35	42	20	K35X42X20H	30.4	48.5	7.65	S	8 100	12 000	0.037	35.000	34.989	42.025	42.009
	35	42	30	K35X42X30FH	40.5	70.0	10.9	S	8 100	12 000	0.061	35.000	34.989	42.025	42.009
	35	45	20	K35X45X20FH	36.5	49.9	8.00	S	8 400	13 000	0.059	35.000	34.989	45.025	45.009
	35	45	30	K35X45X30F	51.2	74.5	11.7	S	8 400	13 000	0.100	35.000	34.989	45.025	45.009
	35	45	35	K35X45X35H	62.1	95.5	15.0	S	8 400	13 000	0.085	35.000	34.989	45.025	45.009
	35	45	41	K35X45X41	70.8	113	17.7	S	8 400	13 000	0.120	35.000	34.989	45.025	45.009
	35	45	49	K35X45X49H	82.5	138	21.4	S	8 400	13 000	0.143	35.000	34.989	45.025	45.009
	35	45	49	K35X45X49HZW	71.8	115	18.1	S	8 400	13 000	0.143	35.000	34.989	45.025	45.009
	35	50	23	K35X50X23H	53.0	60.3	9.75	S	8 700	13 000	0.110	35.000	34.989	50.025	50.009
35	50	40	K35X50X40F	79.7	102	16.2	S	8 700	13 000	0.200	35.000	34.989	50.025	50.009	
36	36	40	29	K36X40X29TN	21.2	45.2	7.15	P	7 600	12 000	0.029	36.000	35.989	40.025	40.009
	36	42	16	K36X42X16	22.8	37.7	5.95	S	7 800	12 000	0.027	36.000	35.989	42.025	42.009
37	37	42	13	K37X42X13H	16.9	29.4	4.50	S	7 500	11 000	0.017	37.000	36.989	42.025	42.009
	37	42	17	K37X42X17H	21.9	41.0	6.35	S	7 500	11 000	0.025	37.000	36.989	42.025	42.009
	37	42	27	K37X42X27F	32.1	66.9	10.4	S	7 500	11 000	0.039	37.000	36.989	42.025	42.009
	37	44	19	K37X44X19H	29.7	48.0	7.65	S	7 600	12 000	0.039	37.000	36.989	44.025	44.009
38	38	41	9	K38X41X9TN	5.93	11.0	1.65	P	7 100	11 000	0.004	38.000	37.989	41.025	41.009
	38	43	17	K38X43X17H	21.8	41.0	6.35	S	7 300	11 000	0.032	38.000	37.989	43.025	43.009
	38	43	27	K38X43X27	31.9	67.0	10.4	S	7 300	11 000	0.041	38.000	37.989	43.025	43.009

[Note] 1) Cage material: P: polymer cage, S: steel cage

Radial needle roller and cage assemblies
single-row, double-row assemblies
metric series
K, K ZW series

Shaft dia. (38) ~ 42 mm

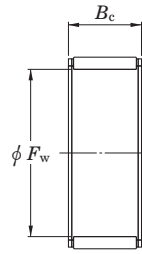

K

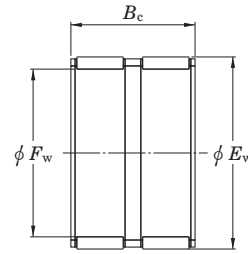

K ZW

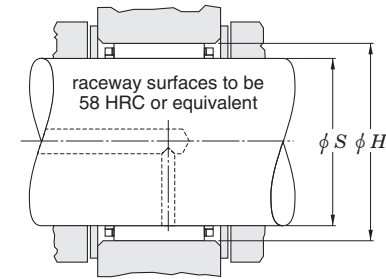

Shaft dia.	Boundary dimensions (mm)			Bearing No.	Basic load ratings (kN)		Fatigue load limit (kN) C _u	Cage material ¹⁾ P / S	Limiting speeds (min ⁻¹)		(Refer.) Mass (kg)	Recommended dimensions (mm)			
	F _w	E _w	B _c -0.20 -0.55		C _r	C _{0r}			Grease lub.	Oil lub.		S (Shaft)		H (Housing)	
												max.	min.	max.	min.
38	38	46	19.8	K38X46X20H	33.3	51.0	8.10	S	7 500	12 000	0.055	38.000	37.989	46.025	46.009
	38	46	32	K38X46X32H	55.2	98.1	15.3	S	7 500	12 000	0.090	38.000	37.989	46.025	46.009
	38	50	25	K38X50X25	53.0	70.8	11.2	S	7 800	12 000	0.100	38.000	37.989	50.025	50.009
	38	50	33	K38X50X33H	68.3	98.2	15.4	S	7 800	12 000	0.126	38.000	37.989	50.025	50.009
	38	50	40	K38X50X40FH	76.2	113	17.8	S	7 800	12 000	0.170	38.000	37.989	50.025	50.009
	40	40	45	13	K40X45X13H	17.6	31.7	4.80	S	6 900	11 000	0.022	40.000	39.989	45.025
40		45	18	K40X45X18H	25.1	50.4	8.00	S	6 900	11 000	0.031	40.000	39.989	45.025	45.009
40		45	21	K40X45X21H	23.3	45.2	8.50	S	6 900	11 000	0.033	40.000	39.989	45.025	45.009
40		45	27	K40X45X27H	32.7	70.2	10.8	S	6 900	11 000	0.040	40.000	39.989	45.025	45.009
40		45	27	K40X45X27TN	33.3	72.1	11.2	P	6 900	11 000	0.030	40.000	39.989	45.025	45.009
40		45	29	K40X45X29H	34.7	75.9	11.7	S	6 900	11 000	0.050	40.000	39.989	45.025	45.009
40		46	17	K40X46X17	25.2	44.0	6.95	S	7 000	11 000	0.033	40.000	39.989	46.025	46.009
40		47	18	K40X47X18	28.0	45.6	7.25	S	7 000	11 000	0.041	40.000	39.989	47.025	47.009
40		47	20	K40X47X20	31.1	52.1	8.25	S	7 000	11 000	0.042	40.000	39.989	47.025	47.009
40		48	20	K40X48X20FV1	35.5	56.3	8.45	S	7 100	11 000	0.052	40.000	39.989	48.025	48.009
40		48	20	K40X48X20H	35.5	56.3	8.95	S	7 100	11 000	0.050	40.000	39.989	48.025	48.009
40		48	35	K40X48X35H	57.3	104	16.3	S	7 100	11 000	0.098	40.000	39.989	48.025	48.009
40		50	27	K40X50X27H	53.0	81.0	12.7	S	7 200	11 000	0.084	40.000	39.989	50.025	50.009
40		55	45	K40X55X45H	103	146	23.0	S	7 500	12 000	0.221	40.000	39.989	55.029	55.010
40		56	26	K40X56X26H	63.7	75.7	12.0	S	7 600	12 000	0.138	40.000	39.989	56.029	56.010
41		41	48	31	K41X48X31HZW	38.0	68.1	10.6	S	6 800	11 000	0.067	41.000	40.989	48.025
42	42	47	13	K42X47X13H	18.7	34.9	5.30	S	6 500	10 000	0.027	42.000	41.989	47.025	47.009
	42	47	17	K42X47X17H	22.8	45.2	7.30	S	6 500	10 000	0.028	42.000	41.989	47.025	47.009
	42	47	27	K42X47X27H	33.8	74.7	11.6	S	6 500	10 000	0.041	42.000	41.989	47.025	47.009
	42	48	24	K42X48X24F	33.1	63.9	10.1	S	6 600	10 000	0.046	42.000	41.989	48.025	48.009
	42	50	13	K42X50X13H	20.9	28.9	4.45	S	6 700	10 000	0.035	42.000	41.989	50.025	50.009
	42	50	20	K42X50X20H	35.2	56.6	9.00	S	6 700	10 000	0.054	42.000	41.989	50.025	50.009
	42	50	30	K42X50X30H	51.3	91.9	14.4	S	6 700	10 000	0.080	42.000	41.989	50.025	50.009

[Note] 1) Cage material: P: polymer cage, S: steel cage

Radial needle roller and cage assemblies
single-row, double-row assemblies
metric series
K, K ZW series

Shaft dia. 43 ~ (47) mm

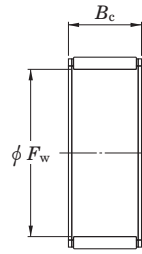

K

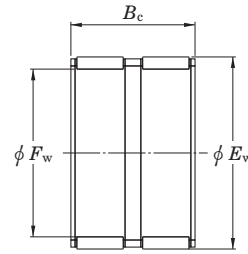

K ZW

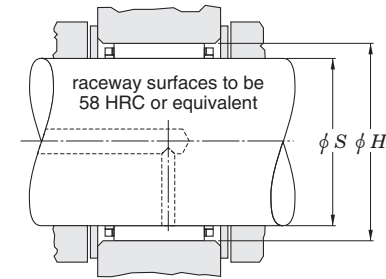

Shaft dia.	Boundary dimensions (mm)			Bearing No.	Basic load ratings (kN)		Fatigue load limit (kN) C _u	Cage material ¹⁾ P / S	Limiting speeds (min ⁻¹)		(Refer.) Mass (kg)	Recommended dimensions (mm)			
	F _w	E _w	B _c -0.20 -0.55		C _r	C _{0r}			Grease lub.	Oil lub.		S (Shaft)		H (Housing)	
												max.	min.	max.	min.
43	43	48	17	K43X48X17FH	23.0	45.8	6.85	S	6 400	9 800	0.036	43.000	42.989	48.025	48.009
	43	48	27	K43X48X27H	34.8	78.0	12.1	S	6 400	9 800	0.050	43.000	42.989	48.025	48.009
44	44	50	22	K44X50X22H	31.6	60.6	9.45	S	6 400	9 900	0.046	44.000	43.989	50.025	50.009
	44	50	30	K44X50X30,5HZW	35.5	70.5	10.7	S	6 400	9 900	0.068	44.000	43.989	50.025	50.009
45	45	50	13	K45X50X13H	18.4	35.1	5.35	S	6 100	9 400	0.022	45.000	44.989	50.025	50.009
	45	50	15	K45X50X15H	19.4	37.3	5.75	S	6 100	9 400	0.028	45.000	44.989	50.025	50.009
	45	50	17	K45X50X17H	24.9	51.8	8.05	S	6 100	9 400	0.030	45.000	44.989	50.025	50.009
	45	50	20	K45X50X20F	27.0	57.4	9.00	S	6 100	9 400	0.040	45.000	44.989	50.025	50.009
	45	50	21	K45X50X21CH	24.6	50.4	7.85	S	6 100	9 400	0.036	45.000	44.989	50.025	50.009
	45	50	27	K45X50X27FH	34.2	77.4	12.0	S	6 100	9 400	0.043	45.000	44.989	50.025	50.009
	45	50	27	K45X50X27TN	31.8	70.7	11.0	P	6 100	9 400	0.048	45.000	44.989	50.025	50.009
	45	52	18	K45X52X18H	30.1	52.0	8.25	S	6 200	9 500	0.045	45.000	44.989	52.029	52.010
	45	52	21	K45X52X21F	35.0	63.2	9.90	S	6 200	9 500	0.055	45.000	44.989	52.029	52.010
	45	53	20	K45X53X20H	36.0	59.5	9.45	S	6 200	9 600	0.054	45.000	44.989	53.029	53.010
	45	53	24.8	K45X53X25H	45.9	81.5	12.7	S	6 200	9 600	0.072	45.000	44.989	53.029	53.010
	45	53	25	K45X53X25F	42.5	73.7	11.7	S	6 200	9 600	0.075	45.000	44.989	53.029	53.010
	45	53	28	K45X53X28H	49.3	89.2	13.9	S	6 200	9 600	0.078	45.000	44.989	53.029	53.010
	45	55	20	K45X55X20H	42.0	62.2	10.0	S	6 400	9 800	0.074	45.000	44.989	55.029	55.010
	45	59	18	K45X59X18H	47.8	58.9	9.60	S	6 600	10 000	0.107	45.000	44.989	59.029	59.010
	45	59	18	K45X59X18TN	45.7	55.4	9.00	P	6 600	10 000	0.097	45.000	44.989	59.029	59.010
	45	59	36	K45X59X36H	82.4	118	18.6	S	6 600	10 000	0.181	45.000	44.989	59.029	59.010
45	60	30	K45X60X30H	75.5	101	16.0	S	6 600	10 000	0.171	45.000	44.989	60.029	60.010	
45	60	45	K45X60X45H	108	160	25.2	S	6 600	10 000	0.280	45.000	44.989	60.029	60.010	
46	46	53	36	K46X53X36HZW	48.6	96.7	15.3	S	6 100	9 300	0.100	46.000	45.989	53.029	53.010
47	47	52	15	K47X52X15FH	20.1	39.8	6.15	S	5 800	8 900	0.030	47.000	46.989	52.029	52.010
	47	52	17	K47X52X17H	24.2	50.4	7.85	S	5 800	8 900	0.032	47.000	46.989	52.029	52.010
	47	52	27	K47X52X27H	36.6	85.9	13.3	S	5 800	8 900	0.045	47.000	46.989	52.029	52.010

[Note] 1) Cage material: P: polymer cage, S: steel cage

Radial needle roller and cage assemblies
single-row, double-row assemblies
metric series
K, K ZW series

Shaft dia. (47) ~ (55) mm

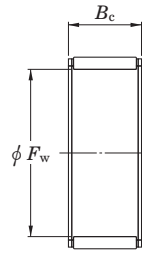

K

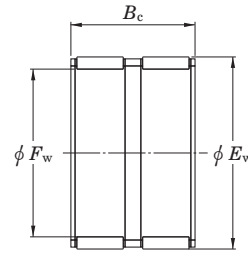

K ZW

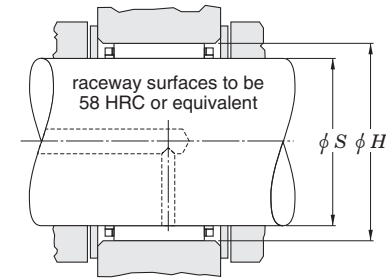

Shaft dia.	Boundary dimensions (mm)			Bearing No.	Basic load ratings (kN)		Fatigue load limit (kN) C _u	Cage material ¹⁾ P / S	Limiting speeds (min ⁻¹)		(Refer.) Mass (kg)	Recommended dimensions (mm)			
	F _w	E _w	B _c -0.20 -0.55		C _r	C _{0r}			Grease lub.	Oil lub.		S (Shaft)		H (Housing)	
												max.	min.	max.	min.
47	47	55	28	K47X55X28FV1	48.9	89.5	14.0	S	6 000	9 200	0.092	47.000	46.989	55.029	55.010
48	48	53	17	K48X53X17H K48X54X19H	25.7	54.9	8.55 9.85	S	5 700	8 700	0.032 0.042	48.000	47.989	53.029	53.010
		48	54		19										
49	49	55	32	K49X55X32HZW K49X65X38H	40.2	86.4	13.4 22.7	S	5 600	8 600	0.080 0.244	49.000	48.989	55.029	55.010
		49	65		38										
50	50	55	17	K50X55X17H	25.5	55.0	8.55	S	5 400	8 400	0.032	50.000	49.989	55.029	55.010
	50	55	20	K50X55X20H	30.2	68.5	10.7	S	5 400	8 400	0.038	50.000	49.989	55.029	55.010
	50	55	30	K50X55X30	38.2	92.4	14.4	S	5 400	8 400	0.057	50.000	49.989	55.029	55.010
	50	55	30	K50X55X30FV1	38.2	92.4	14.4	S	5 400	8 400	0.057	50.000	49.989	55.029	55.010
	50	56	23	K50X56X23	35.5	74.1	11.7	S	5 500	8 500	0.051	50.000	49.989	56.029	56.010
	50	57	18	K50X57X18FH	31.3	56.4	8.95	S	5 500	8 500	0.050	50.000	49.989	57.029	57.010
	50	58	20	K50X58X20H	38.8	67.8	10.8	S	5 600	8 600	0.065	50.000	49.989	58.029	58.010
	50	58	25	K50X58X25H	46.5	85.6	13.4	S	5 600	8 600	0.081	50.000	49.989	58.029	58.010
	50	58	35	K50X58X35H	64.9	131	20.6	S	5 600	8 600	0.105	50.000	49.989	58.029	58.010
	50	62	30	K50X62X30H	64.6	98.1	15.5	S	5 800	8 900	0.136	50.000	49.989	62.029	62.010
	50	66	30	K50X66X30H	80.9	109	17.4	S	5 900	9 100	0.192	50.000	49.989	66.029	66.010
50	70	32	K50X70X32H	103	129	20.6	S	6 100	9 300	0.224	50.000	49.989	70.029	70.010	
52	52	57	12	K52X57X12	18.4	36.7	5.60	S	5 200	8 000	0.022	52.000	51.987	57.029	57.010
	52	57	17	K52X57X17H	21.4	44.3	6.90	S	5 200	8 000	0.035	52.000	51.987	57.029	57.010
	52	60	24	K52X60X24	47.1	88.3	13.9	S	5 400	8 200	0.078	52.000	51.987	60.029	60.010
55	55	60	17	K55X60X17	26.0	58.3	9.10	S	4 900	7 600	0.037	55.000	54.987	60.029	60.010
	55	60	20	K55X60X20H	30.7	72.4	11.3	S	4 900	7 600	0.042	55.000	54.987	60.029	60.010
	55	60	27	K55X60X27H	40.1	102	15.7	S	4 900	7 600	0.055	55.000	54.987	60.029	60.010
	55	60	30	K55X60X30FH	40.6	103	16.1	S	4 900	7 600	0.068	55.000	54.987	60.029	60.010
	55	61	26	K55X61X26H	44.3	102	15.9	S	5 000	7 600	0.063	55.000	54.987	61.029	61.010
	55	62	18	K55X62X18H	33.2	62.8	10.0	S	5 000	7 700	0.055	55.000	54.987	62.029	62.010
	55	63	15	K55X63X15F	30.5	51.5	8.00	S	5 000	7 800	0.054	55.000	54.987	63.029	63.010

[Note] 1) Cage material: P: polymer cage, S: steel cage

Radial needle roller and cage assemblies
single-row, double-row assemblies
metric series
K, K ZW series

Shaft dia. (55) ~ 68 mm

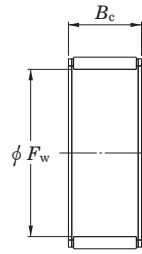

K

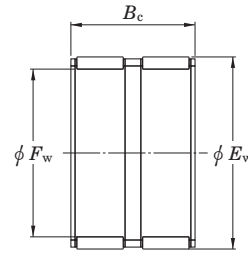

K ZW

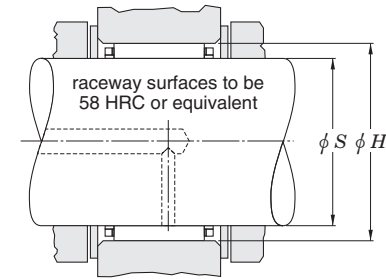

Shaft dia.	Boundary dimensions (mm)			Bearing No.	Basic load ratings (kN)		Fatigue load limit (kN) C_u	Cage material ¹⁾ P / S	Limiting speeds (min ⁻¹)		(Refer.) Mass (kg)	Recommended dimensions (mm)			
	F_w	E_w	B_c -0.20 -0.55		C_r	C_{0r}			Grease lub.	Oil lub.		S (Shaft)		H (Housing)	
												max.	min.	max.	min.
55	55	63	20	K55X63X20	40.3	73.5	11.7	S	5 000	7 800	0.072	55.000	54.987	63.029	63.010
	55	63	25	K55X63X25	49.8	96.5	15.1	S	5 000	7 800	0.080	55.000	54.987	63.029	63.010
	55	63	32	K55X63X32	62.3	129	20.0	S	5 000	7 800	0.108	55.000	54.987	63.029	63.010
58	58	63	17	K58X63X17F	27.0	62.6	9.80	S	4 700	7 200	0.037	58.000	57.987	63.029	63.010
	58	64	19	K58X64X19H	32.9	70.6	11.3	S	4 700	7 200	0.037	58.000	57.987	64.029	64.010
	58	65	18	K58X65X18H	34.3	67.1	10.7	S	4 700	7 300	0.058	58.000	57.987	65.029	65.010
60	60	65	20	K60X65X20H	31.9	78.1	12.2	S	4 500	6 900	0.046	60.000	59.987	65.029	65.010
	60	65	26.8	K60X65X27FH	39.5	103	16.0	S	4 500	6 900	0.059	60.000	59.987	65.029	65.010
	60	65	29.8	K60X65X30FH	42.9	114	17.8	S	4 500	6 900	0.085	60.000	59.987	65.029	65.010
	60	65	30	K60X65X30	42.9	114	17.8	S	4 500	6 900	0.070	60.000	59.987	65.029	65.010
	60	68	17	K60X68X17F	34.2	61.4	9.50	S	4 600	7 100	0.066	60.000	59.987	68.029	68.010
	60	68	20	K60X68X20H	41.8	79.2	12.6	S	4 600	7 100	0.066	60.000	59.987	68.029	68.010
	60	68	23	K60X68X23H	49.0	97.2	15.4	S	4 600	7 100	0.089	60.000	59.987	68.029	68.010
	60	68	25	K60X68X25	51.6	104	16.3	S	4 600	7 100	0.091	60.000	59.987	68.029	68.010
	60	68	30	K60X68X30ZW	46.4	90.1	13.9	S	4 600	7 100	0.119	60.000	59.987	68.029	68.010
63	63	71	20	K63X71X20	41.4	79.4	12.7	S	4 400	6 700	0.070	63.000	62.987	71.029	71.010
64	64	70	16	K64X70X16	26.4	55.1	8.55	S	4 200	6 500	0.049	64.000	63.987	70.029	70.010
65	65	70	20	K65X70X20CH	28.6	69.2	10.8	S	4 100	6 400	0.050	65.000	64.987	70.029	70.010
	65	70	30	K65X70X30	44.4	123	19.1	S	4 100	6 400	0.075	65.000	64.987	70.029	70.010
	65	73	23	K65X73X23H	48.2	97.7	15.5	S	4 200	6 500	0.091	65.000	64.987	73.029	73.010
	65	73	30	K65X73X30H	60.1	129	20.3	S	4 200	6 500	0.116	65.000	64.987	73.029	73.010
68	68	74	20	K68X74X20FH	37.5	88.1	13.2	S	4 000	6 100	0.062	68.000	67.987	74.029	74.010
	68	74	28	K68X74X28CH	44.8	110	17.1	S	4 000	6 100	0.082	68.000	67.987	74.029	74.010
	68	74	30	K68X74X30H	47.6	119	18.5	S	4 000	6 100	0.098	68.000	67.987	74.029	74.010
	68	74	35	K68X74X35HZW	45.1	111	17.1	S	4 000	6 100	0.120	68.000	67.987	74.029	74.010
	68	76	20	K68X76X20	43.8	87.8	14.0	S	4 000	6 200	0.086	68.000	67.987	76.029	76.010

[Note] 1) Cage material: P: polymer cage, S: steel cage

Radial needle roller and cage assemblies
single-row, double-row assemblies
metric series
K, K ZW series

Shaft dia. 70 ~ 95 mm

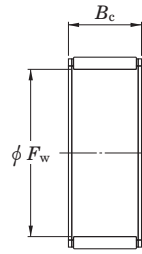

K

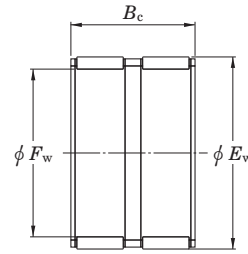

K ZW

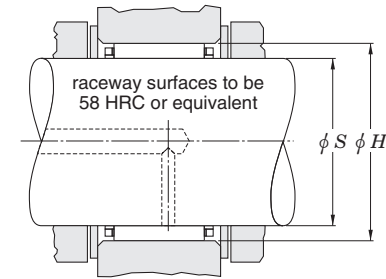

Shaft dia.	Boundary dimensions (mm)			Bearing No.	Basic load ratings (kN)		Fatigue load limit (kN) C _u	Cage material ¹⁾ P / S	Limiting speeds (min ⁻¹)		(Refer.) Mass (kg)	Recommended dimensions (mm)			
	F _w	E _w	B _c -0.20 -0.55		C _r	C _{0r}			Grease lub.	Oil lub.		S (Shaft)		H (Housing)	
	max.	min.			max.	min.			max.	min.		max.	min.		
70	70	76	20	K70X76X20	36.1	84.7	13.5	S	3 900	5 900	0.065	70.000	69.987	76.029	76.010
	70	76	30	K70X76X30	51.6	134.0	20.9	S	3 900	5 900	0.097	70.000	69.987	76.029	76.010
	70	78	20	K70X78X20H	43.6	87.9	14.0	S	3 900	6 000	0.090	70.000	69.987	78.029	78.010
	70	78	23	K70X78X23F	49.8	104.0	16.6	S	3 900	6 000	0.115	70.000	69.987	78.029	78.010
	70	78	24.8	K70X78X25F	49.8	104.0	16.6	S	3 900	6 000	0.115	70.000	69.987	78.029	78.010
	70	78	30	K70X78X30H	62.2	139.0	21.8	S	3 900	6 000	0.140	70.000	69.987	78.029	78.010
	70	78	46	K70X78X46ZW	78.4	187.0	29.5	S	3 900	6 000	0.188	70.000	69.987	78.029	78.010
	70	85	40	K70X85X40F	118	203	32.4	S	4 100	6 300	0.338	70.000	69.987	85.034	85.012
	70	88	30	K70X88X30H	115	175	28.1	S	4 100	6 400	0.205	70.000	69.987	88.034	88.012
72	72	80	20	K72X80X20	44.4	90.7	14.5	S	3 800	5 800	0.084	72.000	71.987	80.029	80.010
73	73	79	20	K73X79X20	37.0	88.7	14.1	S	3 700	5 700	0.068	73.000	72.987	79.029	79.010
75	75	81	20	K75X81X20F	37.4	90.7	14.5	S	3 600	5 500	0.075	75.000	74.987	81.034	81.012
	75	83	23	K75X83X23	52.5	114.0	18.2	S	3 600	5 600	0.104	75.000	74.987	83.034	83.012
	75	83	30	K75X83X30	60.9	138	21.7	S	3 600	5 600	0.141	75.000	74.987	83.034	83.012
	75	83	30	K75X83X30FH	60.9	138	21.7	S	3 600	5 600	0.141	75.000	74.987	83.034	83.012
80	80	86	20	K80X86X20H	38.6	96.7	15.4	S	3 400	5 200	0.072	80.000	79.987	86.034	86.012
	80	88	25	K80X88X25FV1	54.0	121	19.2	S	3 400	5 200	0.134	80.000	79.987	88.034	88.012
	80	88	30	K80X88X30	67.5	161	25.4	S	3 400	5 200	0.153	80.000	79.987	88.034	88.012
85	85	92	20	K85X92X20H	39.9	91.7	14.6	S	3 200	4 900	0.085	84.988	84.973	92.034	92.012
	85	93	25	K85X93X25F	58.8	138	21.7	S	3 200	4 900	0.128	84.988	84.973	93.034	93.012
	85	93	30	K85X93X30H	69.4	170.4	26.8	S	3 200	4 900	0.166	84.988	84.973	93.034	93.012
90	90	97	20	K90X97X20	46.3	114	18.1	S	3 000	4 600	0.095	89.988	89.973	97.034	97.012
	90	98	25	K90X98X25F	54.8	128	20.3	S	3 000	4 600	0.134	89.988	89.973	98.034	98.012
	90	98	30	K90X98X30	63.6	155	24.3	S	3 000	4 600	0.168	89.988	89.973	98.034	98.012
95	95	103	20	K95X103X20	49.3	114	18.3	S	2 800	4 400	0.130	94.988	94.973	103.034	103.012
	95	103	30	K95X103X30F	71.0	183	28.6	S	2 800	4 400	0.180	94.988	94.973	103.034	103.012

[Note] 1) Cage material: P: polymer cage, S: steel cage

Radial needle roller and cage assemblies
single-row, double-row assemblies
metric series
K, K ZW series

Shaft dia. 100 ~ 110 mm

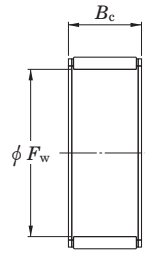

K

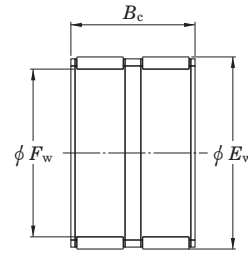

K ZW

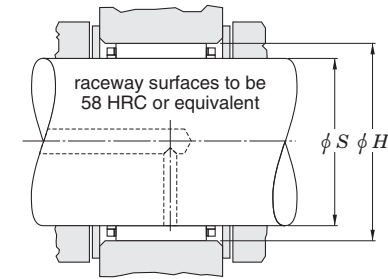

Shaft dia.	Boundary dimensions (mm)			Bearing No.	Basic load ratings (kN)		Fatigue load limit (kN) <i>C_u</i>	Cage material ¹⁾ P / S	Limiting speeds (min ⁻¹)		(Refer.) Mass (kg)	Recommended dimensions (mm)			
	<i>F_w</i>	<i>E_w</i>	<i>B_c</i> -0.20 -0.55		<i>C_r</i>	<i>C_{0r}</i>			Grease lub.	Oil lub.		<i>S</i> (Shaft)		<i>H</i> (Housing)	
	max.	min.										max.	min.	max.	min.
100	100	108	30	K100X108X30	72.4	191	29.5	S	2 700	4 200	0.210	99.988	99.973	108.034	108.012
110	110	118	24	K110X118X24	64.0	168	25.6	S	2 400	3 800	0.165	109.988	109.973	118.034	118.012
	110	118	30	K110X118X30H	75.3	207	31.2	S	2 400	3 800	0.200	109.988	109.973	118.034	118.012

[Note] 1) Cage material: P: polymer cage, S: steel cage

Radial needle roller and cage assemblies
single-row assemblies
inch series

Shaft dia. $\frac{3}{8} \sim (1 \frac{1}{2})$ in
 (9.525 ~ (38.100) mm)

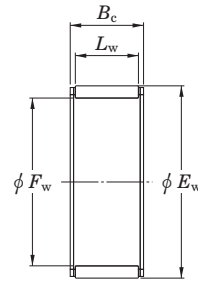

WJ, WJC

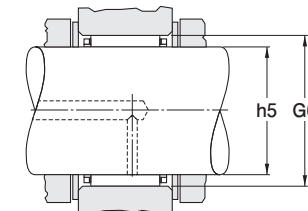

raceway surfaces to be
58 HRC or equivalent

Shaft dia. (in)	Boundary dimensions (mm)			Bearing No.	Basic load ratings (kN)		Fatigue load limit (kN) C_u	Limiting speeds (min ⁻¹)		Recommended dimensions (mm)				(Refer.) Mass (kg)
	F_w	E_w	B_c $^{+0}_{-0.38}$		C_r	C_{Or}		Grease lub.	Oil lub.	Shaft dia. (h5) max.	min.	Housing bore dia. (G6) max.	min.	
$\frac{3}{8}$	9.525	12.700	9.53	WJC-060806	3.87	4.00	0.600	24 000	37 000	9.525	9.520	12.715	12.705	0.003
$\frac{1}{2}$	12.700	15.875	12.70	WJC-081008	6.23	8.01	1.65	23 000	35 000	12.700	12.692	15.890	15.880	0.005
$\frac{9}{16}$	14.288	17.463	12.70	WJC-091108	6.81	9.25	1.40	22 000	34 000	14.288	14.280	17.478	17.468	0.006
$\frac{5}{8}$	15.875	19.050	12.70	WJC-101208	7.03	9.96	1.50	18 000	27 000	15.875	15.867	19.070	19.058	0.006
	15.875	22.225	15.88	WJ-101410	15.6	17.8	2.80	19 000	29 000	15.875	15.867	22.245	22.233	0.012
	15.875	22.225	22.23	WJ-101414	21.3	26.4	4.10	19 000	29 000	15.875	15.867	22.245	22.233	0.017
$\frac{3}{4}$	19.050	25.400	25.40	WJ-121616	26.8	37.2	5.80	16 000	24 000	19.050	19.040	25.420	25.408	0.023
$\frac{13}{16}$	20.638	26.988	22.23	WJ-131714	25.1	35.0	5.50	14 000	22 000	20.638	20.627	27.008	26.995	0.021
$\frac{7}{8}$	22.225	28.575	25.40	WJ-141816	29.2	43.5	6.75	13 000	20 000	22.225	22.215	28.595	28.583	0.026
1	25.400	33.338	19.05	WJ-162112	28.1	37.1	5.90	12 000	18 000	25.400	25.390	33.363	33.348	0.029
	25.400	33.338	25.40	WJ-162116	36.8	52.5	8.20	12 000	18 000	25.400	25.390	33.363	33.348	0.038
	25.400	33.338	31.75	WJ-162120	44.5	67.2	10.5	12 000	18 000	25.400	25.390	33.363	33.348	0.048
$1 \frac{1}{8}$	28.575	38.100	25.40	WJ-182416	42.4	57.8	9.05	10 000	16 000	28.575	28.565	38.125	38.110	0.041
	28.575	38.100	31.75	WJ-182420	52.0	74.7	11.7	10 000	16 000	28.575	28.565	38.125	38.110	0.065
$1 \frac{1}{4}$	31.750	41.275	19.05	WJ-202612	33.4	43.7	7.05	9 300	14 000	31.750	31.740	41.300	41.285	0.043
	31.750	41.275	25.40	WJ-202616	44.1	62.3	9.80	9 300	14 000	31.750	31.740	41.300	41.285	0.061
	31.750	41.275	31.75	WJ-202620	53.8	81.0	12.6	9 300	14 000	31.750	31.740	41.300	41.285	0.071
	31.750	41.275	38.10	WJ-202624	63.6	99.6	15.6	9 300	14 000	31.750	31.740	41.300	41.285	0.085
$1 \frac{3}{8}$	34.925	44.450	25.40	WJ-222816	45.8	67.2	10.5	8 300	13 000	34.925	34.915	44.475	44.460	0.067
	34.925	44.450	31.75	WJ-222820	56.0	87.2	13.6	8 300	13 000	34.925	34.915	44.475	44.460	0.077
$1 \frac{1}{2}$	38.100	47.625	25.40	WJ-243016	47.2	71.6	11.3	7 600	12 000	38.100	38.090	47.650	47.635	0.078
	38.100	47.625	31.75	WJ-243020	57.8	93.0	14.5	7 600	12 000	38.100	38.090	47.650	47.635	0.083

[Remarks] 1) Load ratings are based on a minimum raceway hardness of 58 HRC or equivalent.
 2) Minimum axial clearance should be 0.02 mm (0.008 in).

Radial needle roller and cage assemblies
single-row assemblies
inch series

Shaft dia. (1 1/2) ~ 3 in
 ((38.100) ~ 76.200 mm)

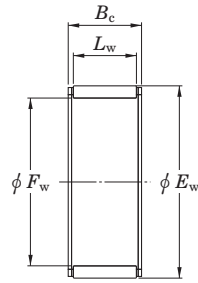

WJ, WJC

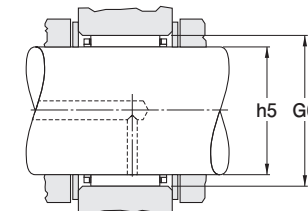

raceway surfaces to be
58 HRC or equivalent

Shaft dia. (in)	Boundary dimensions (mm)			Bearing No.	Basic load ratings (kN)		Fatigue load limit (kN) Cu	Limiting speeds (min ⁻¹)		Recommended dimensions (mm)				(Refer.) Mass (kg)
	Fw	Ew	Bc +0 -0.38		Cr	Cor		Grease lub.	Oil lub.	Shaft dia. (h5)		Housing bore dia. (G6)		
										max.	min.	max.	min.	
1 1/2	38.100	47.625	38.10	WJ-243024	68.1	114.8	18.0	7 600	12 000	38.100	38.090	47.650	47.635	0.100
	38.100	47.625	44.45	WJ-243028	77.4	135.7	21.2	7 600	12 000	38.100	38.090	47.650	47.635	0.134
1 3/4	44.450	53.975	19.05	WJ-283412	39.5	59.6	9.60	6 400	9 900	44.450	44.440	54.003	53.985	0.058
	44.450	53.975	25.40	WJ-283416	52.0	85.0	13.4	6 400	9 900	44.450	44.440	54.003	53.985	0.084
	44.450	53.975	38.10	WJ-283424	74.7	136	21.3	6 400	9 900	44.450	44.440	54.003	53.985	0.115
2	50.800	60.325	19.05	WJ-323812	42.8	69.0	11.1	5 600	8 600	50.800	50.787	60.353	60.335	0.065
	50.800	60.325	25.40	WJ-323816	56.5	98.0	15.5	5 600	8 600	50.800	50.787	60.353	60.335	0.105
	50.800	60.325	31.75	WJ-323820	69.0	127	20.0	5 600	8 600	50.800	50.787	60.353	60.335	0.108
	50.800	60.325	38.10	WJ-323824	81.0	157	24.6	5 600	8 600	50.800	50.787	60.353	60.335	0.130
2 1/16	52.388	61.913	25.40	WJ-333916	57.8	102	16.2	5 400	8 300	52.388	52.375	61.940	61.923	0.099
2 1/8	53.975	63.500	25.40	WJ-344016	52.5	92.08	14.6	5 200	8 000	53.975	53.962	63.528	63.510	0.089
	53.975	63.500	38.10	WJ-344024	78.3	153	24.0	5 200	8 000	53.975	53.962	63.528	63.510	0.137
2 3/16	55.563	65.088	19.05	WJ-354112	44.5	75.17	12.2	5 000	7 800	55.563	55.550	65.115	65.098	0.070
	55.563	65.088	25.40	WJ-354116	57.8	107	16.9	5 000	7 800	55.563	55.550	65.115	65.098	0.094
2 1/4	57.150	66.675	25.40	WJ-364216	53.8	96.08	15.2	4 900	7 500	57.150	57.137	66.703	66.685	0.096
	57.150	66.675	31.75	WJ-364220	67.6	128	20.1	4 900	7 500	57.150	57.137	66.703	66.685	0.120
2 3/8	60.325	69.850	38.10	WJ-384424	81.4	167	26.1	4 600	7 100	60.325	60.312	69.878	69.860	0.151
2 1/2	63.500	73.025	25.40	WJ-404616	55.6	104	16.5	4 400	6 700	63.500	63.487	73.053	73.035	0.106
	63.500	73.025	31.75	WJ-404620	69.8	139	21.8	4 400	6 700	63.500	63.487	73.053	73.035	0.132
	63.500	73.025	38.10	WJ-404624	83.2	173	27.2	4 400	6 700	63.500	63.487	73.053	73.035	0.179
2 3/4	69.850	79.375	25.40	WJ-445016	57.8	112.54	17.8	4 000	6 100	69.850	69.837	79.403	79.385	0.116
3	76.200	85.725	25.40	WJ-485416	59.6	120.55	19.1	3 600	5 600	76.200	76.187	85.761	85.738	0.126
	76.200	85.725	38.10	WJ-485424	85.4	191.72	29.9	3 600	5 600	76.200	76.187	85.761	85.738	0.189

(Remarks) 1) Load ratings are based on a minimum raceway hardness of 58 HRC or equivalent.
 2) Minimum axial clearance should be 0.02 mm (0.008 in).

Radial needle roller and cage assemblies
single-row assemblies
inch series

Shaft dia. 3 1/4 ~ 5 in
 (82.550 ~ 127.000 mm)

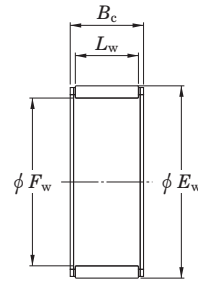

WJ, WJC

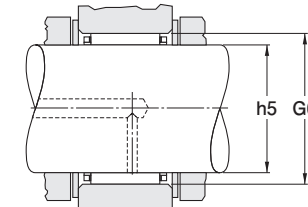

raceway surfaces to be
58 HRC or equivalent

Shaft dia. (in)	Boundary dimensions (mm)			Bearing No.	Basic load ratings (kN)		Fatigue load limit (kN) C _u	Limiting speeds (min ⁻¹)		Recommended dimensions (mm)				(Refer.) Mass (kg)
	F _w	E _w	B _c +0 -0.38		C _r	C _{0r}		Grease lub.	Oil lub.	Shaft dia. (h5)		Housing bore dia. (G6)		
										max.	min.	max.	min.	
3 1/4	82.550	92.075	25.40	WJ-525816	61.4	128.55	20.4	3 300	5 100	82.550	82.535	92.111	92.088	0.136
	82.550	92.075	38.10	WJ-525824	88.1	204.62	31.9	3 300	5 100	82.550	82.535	92.111	92.088	0.220
3 1/2	88.900	98.425	25.40	WJ-566216	63.2	136.56	21.7	3 100	4 700	88.900	88.885	98.461	98.438	0.146
	88.900	101.600	25.40	WJ-566416	79.6	150.35	23.9	3 100	4 800	88.900	88.885	101.636	101.613	0.197
	88.900	101.600	38.10	WJ-566424	113	237.53	37.4	3 100	4 800	88.900	88.885	101.636	101.613	0.296
4	101.600	114.300	25.40	WJ-647216	83.6	166.59	30.9	2 700	4 200	101.600	101.585	114.336	114.313	0.224
	101.600	114.300	38.10	WJ-647224	119	263.33	40.6	2 700	4 200	101.600	101.585	114.336	114.313	0.335
5	127.000	152.400	38.10	WJ-809624	211	365.20	51.9	2 200	3 400	127.000	126.982	152.438	152.415	1.018

[Remarks] 1) Load ratings are based on a minimum raceway hardness of 58 HRC or equivalent.
 2) Minimum axial clearance should be 0.02 mm (0.008 in).

Drawn cup needle roller bearings
caged,
open ends, closed one end
metric series
HK, BK series

Shaft dia. 3 ~ (10) mm

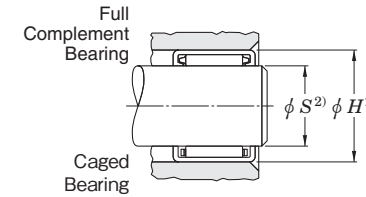
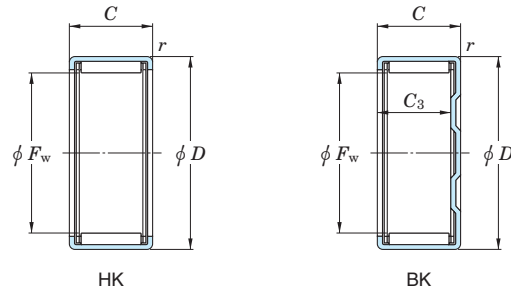

Shaft surface to be
58 HRC or equivalent

Shaft dia.	Boundary dimensions (mm)					Bearing No.	Basic load ratings (kN)		Fatigue load limit (kN)	Limiting speeds (min ⁻¹)		(Refer.) Mass (kg)	Inspection gage	Mounting inner ring (pages B466 to B475)
	F _w	D	C ₊₀ -0.3	C _{min.}	r _{min.}		C _r	C _{0r}	C _u	Grease lub.	Oil lub.			
3	3	6.5	6	5.20	0.30	BK0306	1.20	0.78	0.130	30 000	46 000	0.001	Table 4	
	3	6.5	6	—	0.30	HK0306	1.60	1.14	0.130	30 000	46 000	0.001	Table 4	
4	4	8	8	6.40	0.40	BK0408	1.83	1.32	0.200	25 000	39 000	0.002	Table 4	
	4	8	8	—	0.40	HK0408	1.88	1.38	0.200	25 000	39 000	0.002	Table 4	
5	5	9	9	7.40	0.40	BK0509	2.52	2.07	0.320	23 000	36 000	0.002	Table 4	
	5	9	9	—	0.40	HK0509	2.52	2.07	0.320	23 000	36 000	0.002	Table 4	
6	6	10	8	6.40	0.40	BK0608	2.34	1.95	0.290	22 000	33 000	0.002	Table 4	
	6	10	8	—	0.40	HK0608	2.34	1.95	0.290	22 000	33 000	0.002	Table 4	
	6	10	9	7.40	0.40	BK0609	3.14	2.85	0.290	22 000	33 000	0.003	Table 4	
	6	10	9	—	0.40	HK0609	3.14	2.85	0.290	22 000	33 000	0.002	Table 4	
7	7	11	9	7.40	0.40	BK0709	3.24	3.10	0.470	21 000	32 000	0.003	Table 4	
	7	11	9	—	0.40	HK0709	3.23	3.05	0.470	21 000	32 000	0.003	Table 4	
8	8	12	8	6.40	0.40	BK0808	2.90	2.73	0.400	20 000	31 000	0.003	Table 4	
	8	12	8	—	0.40	HK0808	2.90	2.73	0.400	20 000	31 000	0.003	Table 4	
	8	12	10	8.40	0.40	BK0810	3.93	4.14	0.600	20 000	31 000	0.004	Table 4	JR5x8x12
	8	12	10	—	0.40	HK0810	3.95	4.07	0.600	20 000	31 000	0.004	Table 4	JR5x8x12
9	9	13	10	8.40	0.40	BK0910	4.57	5.07	0.770	19 000	30 000	0.004	Table 4	JR6x9x12
	9	13	10	—	0.40	HK0910	4.57	5.07	0.770	19 000	30 000	0.004	Table 4	JR6x9x12
	9	13	12	10.40	0.40	BK0912	5.65	6.65	1.00	19 000	30 000	0.005	Table 4	JR6x9x12
	9	13	12	—	0.40	HK0912	5.65	6.65	1.00	19 000	30 000	0.005	Table 4	JR6x9x12
10	10	14	10	8.40	0.40	BK1010	4.78	5.51	0.840	19 000	29 000	0.004	Table 4	JR7x10x10,5
	10	14	10	—	0.40	HK1010	4.78	5.51	0.840	19 000	29 000	0.004	Table 4	JR7x10x10,5
	10	14	12	10.40	0.40	BK1012	5.90	7.23	1.10	19 000	29 000	0.006	Table 4	JR7x10x12
	10	14	12	—	0.40	HK1012	5.90	7.23	1.10	19 000	29 000	0.005	Table 4	JR7x10x12

[Notes] 1) Drawn cup needle roller bearings with two needle roller and cage assemblies and one lubricating hole.
 2) For the recommended mounting dimensions see Table 20.

Drawn cup needle roller bearings
caged,
open ends, closed one end
metric series
HK, BK series

Shaft dia. (10) ~ (18) mm

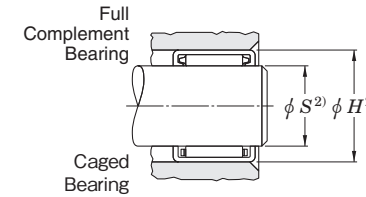
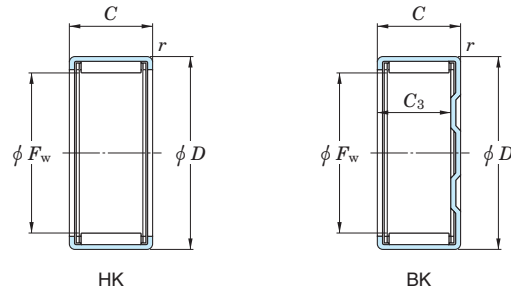

Shaft surface to be 58 HRC or equivalent

Shaft dia.	Boundary dimensions (mm)					Bearing No.	Basic load ratings (kN)		Fatigue load limit (kN)	Limiting speeds (min ⁻¹)		(Refer.) Mass (kg)	Inspection gage	Mounting inner ring (pages B466 to B475)
	F _w	D	C ₊₀ -0.3	C ₃ min.	r min.		C _r	C _{0r}	C _u	Grease lub.	Oil lub.			
10	10	14	15	13.40	0.40	BK1015	7.49	9.81	1.50	19 000	29 000	0.006	Table 4	JR7x10x16
	10	14	15	—	0.40	HK1015	7.49	9.81	1.50	19 000	29 000	0.006	Table 4	JR7x10x16
12	12	16	10	8.40	0.4	BK1210	4.96	6.08	0.890	18 000	28 000	0.006	Table 4	JR8x12x10,5
	12	16	10	—	0.4	HK1210	4.96	6.08	0.890	18 000	28 000	0.006	Table 4	JR8x12x10,5
	12	18	12	9.30	1	BK1212	6.61	7.29	1.10	14 000	22 000	0.012	Table 4	JR8x12x12,5
	12	18	12	—	1	HK1212	6.61	7.29	1.10	14 000	22 000	0.01	Table 4	JR8x12x12,5
13	13	19	12	9.30	1	BK1312	6.92	7.89	1.20	14 000	22 000	0.012	Table 4	JR10x13x12,5
	13	19	12	—	1	HK1312	6.92	7.89	1.20	14 000	22 000	0.01	Table 4	JR10x13x12,5
14	14	20	12	9.30	1	BK1412	7.21	8.50	1.30	14 000	21 000	0.014	Table 4	JR10x14x12
	14	20	12	—	1	HK1412	7.21	8.50	1.30	14 000	21 000	0.011	Table 4	JR10x14x12
15	15	21	12	9.30	1	BK1512	7.16	8.57	1.40	14 000	21 000	0.015	Table 4	JR12x15x12,5
	15	21	12	—	1	HK1512	7.49	9.11	1.40	14 000	21 000	0.012	Table 4	JR12x15x12,5
	15	21	16	13.30	1	BK1516	10.70	14.4	2.20	14 000	21 000	0.019	Table 4	JR12x15x16,5
	15	21	16	—	1	HK1516	10.70	14.4	2.20	14 000	21 000	0.018	Table 4	JR12x15x16,5
	15	21	22	19.30	1	BK1522 ¹⁾	13.50	19.4	2.95	14 000	21 000	0.022	Table 4	JR12x15x22,5
	15	21	22	—	1	HK1522 ¹⁾	13.50	19.4	2.95	14 000	21 000	0.024	Table 4	JR12x15x22,5
16	16	22	12	9.30	1	BK1612	7.76	9.72	1.50	14 000	21 000	0.016	Table 4	JR12x16x12
	16	22	12	—	1	HK1612	7.76	9.72	1.50	14 000	21 000	0.012	Table 4	JR12x16x12
	16	22	16	13.30	1	BK1616	11.1	15.3	2.35	14 000	21 000	0.02	Table 4	JR12x16x16
	16	22	16	—	1	HK1616	11.1	15.3	2.35	14 000	21 000	0.016	Table 4	JR12x16x16
	16	22	22	19.30	1	BK1622 ¹⁾	13.4	19.5	2.95	14 000	21 000	0.028	Table 4	JR12x16x22
	16	22	22	—	1	HK1622 ¹⁾	13.40	19.5	2.95	14 000	21 000	0.022	Table 4	JR12x16x22
17	17	23	12	9.30	1	BK1712	8.12	10.4	1.60	13 000	20 000	0.018	Table 4	
	17	23	12	—	1	HK1712	8.12	10.4	1.60	13 000	20 000	0.013	Table 4	
18	18	24	12	9.30	1	BK1812	8.41	11.11	1.70	12 000	18 000	0.017	Table 4	

[Notes] 1) Drawn cup needle roller bearings with two needle roller and cage assemblies and one lubricating hole.
 2) For the recommended mounting dimensions see Table 20.

Drawn cup needle roller bearings
caged,
open ends, closed one end
metric series
HK, BK series

Shaft dia. (18) ~ (25) mm

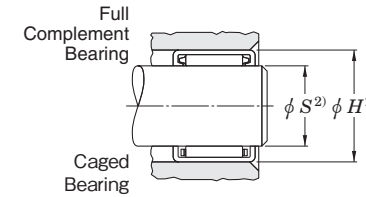
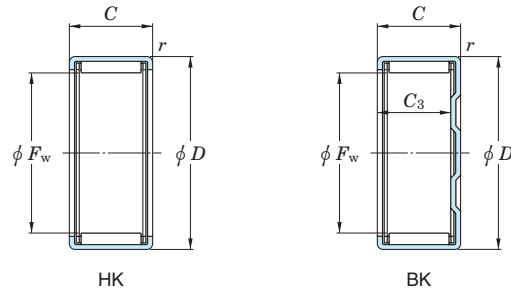

Shaft surface to be
58 HRC or equivalent

Shaft dia.	Boundary dimensions (mm)					Bearing No.	Basic load ratings (kN)		Fatigue load limit (kN)	Limiting speeds (min ⁻¹)		(Refer.) Mass (kg)	Inspection gage	Mounting inner ring (pages B466 to B475)
	F_w	D	C +0 -0.3	C_3 min.	r min.		C_r	C_{Or}	C_u	Grease lub.	Oil lub.			
18	18	24	12	—	1	HK1812	8.41	11.11	1.70	12 000	18 000	0.015	Table 4	JR15x18x16,5 JR15x18x16,5
	18	24	16	13.30	1	BK1816	11.6	16.8	2.55	12 000	18 000	0.022	Table 4	
	18	24	16	—	1	HK1816	11.6	16.8	2.55	12 000	18 000	0.018	Table 4	
20	20	26	12	9.3	1	BK2012	8.97	12.5	1.90	11 000	16 000	0.017	Table 4	JR15x20x12 JR15x20x12 JR17x20x16,5 JR17x20x16,5 JR17x20x20,5 JR17x20x20,5 JR17x20x30,5 JR17x20x30,5
	20	26	12	—	1	BK2012	8.97	12.5	1.90	11 000	16 000	0.015	Table 4	
	20	26	16	13.3	1	BK2016	12.40	18.90	2.85	11 000	16 000	0.024	Table 4	
	20	26	16	—	1	HK2016	12.40	18.90	2.85	11 000	16 000	0.022	Table 4	
	20	26	20	17.3	1	BK2020	15.50	25.30	3.95	11 000	16 000	0.027	Table 4	
	20	26	20	—	1	HK2020	15.90	26.20	3.95	11 000	16 000	0.025	Table 4	
	20	26	30	27.3	1	BK2030 ¹⁾	21.20	37.80	5.75	11 000	16 000	0.043	Table 4	
	20	26	30	—	1	HK2030 ¹⁾	21.20	37.80	5.75	11 000	16 000	0.041	Table 4	
22	22	28	10	8.4	1	BK2210	7.06	9.49	1.45	9 600	15 000	0.013	Table 4	JR17x22x13 JR17x22x13 JR17x22x13 JR17x22x16 JR17x22x16 JR17x22x23 JR17x22x23
	22	28	10	—	1	HK2210	7.06	9.49	1.45	9 600	15 000	0.013	Table 4	
	22	28	12	9.3	1	BK2212	9.81	14.50	2.20	9 600	15 000	0.02	Table 4	
	22	28	12	—	1	HK2212	9.81	14.50	2.20	9 600	15 000	0.015	Table 4	
	22	28	16	13.3	1	BK2216	13.10	20.90	3.20	9 600	15 000	0.027	Table 4	
	22	28	16	—	1	HK2216	13.10	20.90	3.20	9 600	15 000	0.022	Table 4	
	22	28	20	17.3	1	BK2220	15.30	25.50	4.00	9 600	15 000	0.028	Table 4	
	22	28	20	—	1	HK2220	15.30	25.50	4.00	9 600	15 000	0.026	Table 4	
25	25	32	12	9.30	1	BK2512	10.90	14.70	2.25	8 500	13 000	0.025	Table 4	JR20x25x17 JR20x25x17 JR20x25x20,5 JR20x25x20,5 JR20x25x26,5 JR20x25x26,5
	25	32	12	—	1	HK2512	10.90	14.70	2.25	8 500	13 000	0.021	Table 4	
	25	32	16	13.3	1	BK2516	15.60	23.50	3.55	8 500	13 000	0.031	Table 4	
	25	32	16	—	1	HK2516	15.60	23.50	3.55	8 500	13 000	0.028	Table 4	
	25	32	20	17.3	1	BK2520	20.60	33.40	5.30	8 500	13 000	0.043	Table 4	
	25	32	20	—	1	HK2520	20.60	33.40	5.30	8 500	13 000	0.040	Table 4	
	25	32	26	23.3	1	BK2526	25.70	44.40	6.95	8 500	13 000	0.051	Table 4	
	25	32	26	—	1	HK2526	25.70	44.40	6.95	8 500	13 000	0.046	Table 4	

[Notes] 1) Drawn cup needle roller bearings with two needle roller and cage assemblies and one lubricating hole.
 2) For the recommended mounting dimensions see Table 20.

Drawn cup needle roller bearings
caged,
open ends, closed one end
metric series
HK, BK series

Shaft dia. (25) ~ (45) mm

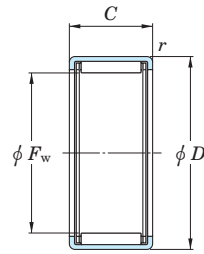

HK

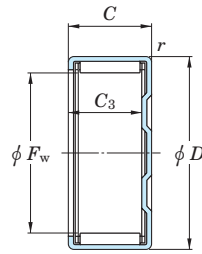

BK

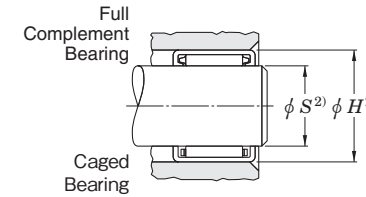

Shaft surface to be
58 HRC or equivalent

Shaft dia.	Boundary dimensions (mm)					Bearing No.	Basic load ratings (kN)		Fatigue load limit (kN)	Limiting speeds (min ⁻¹)		(Refer.) Mass (kg)	Inspection gage	Mounting inner ring (pages B466 to B475)
	F _w	D	C ₊₀ -0.3	C ₃ min.	r min.		C _r	C _{0r}	C _u	Grease lub.	Oil lub.			
25	25	32	38	35.3	1	BK2538 ¹⁾	35.30	66.90	10.6	8 500	13 000	0.077	Table 4	JR20x25x38,5
	25	32	38	—	1	HK2538 ¹⁾	35.30	66.90	10.6	8 500	13 000	0.068	Table 4	JR20x25x38,5
28	28	35	16	13.30	1	BK2816	15.9	24.9	3.85	7 500	12 000	0.038	Table 4	JR22x28x17
	28	35	16	—	1	HK2816	15.9	24.9	3.85	7 500	12 000	0.032	Table 4	JR22x28x17
	28	35	20	17.3	1	BK2820	20.9	35.3	5.60	7 500	12 000	0.047	Table 4	JR22x28x20,5
	28	35	20	—	1	HK2820	20.9	35.3	5.60	7 500	12 000	0.040	Table 4	JR22x28x20,5
30	30	37	12	9.3	1	BK3012	11.6	16.8	2.90	7 000	11 000	0.031	Table 4	JR25x30x17
	30	37	12	—	1	HK3012	12.0	17.7	2.70	7 000	11 000	0.024	Table 4	
	30	37	16	13.30	1	BK3016	16.8	27.3	4.20	7 000	11 000	0.041	Table 4	
	30	37	16	—	1	HK3016	16.8	27.3	4.20	7 000	11 000	0.032	Table 4	JR25x30x17
	30	37	20	17.3	1	BK3020	22.4	39.6	6.25	7 000	11 000	0.053	Table 4	JR25x30x20,5
	30	37	20	—	1	HK3020	22.4	39.6	6.25	7 000	11 000	0.042	Table 4	JR25x30x20,5
	30	37	26	23.3	1	BK3026	27.4	51.2	7.95	7 000	11 000	0.067	Table 4	JR25x30x26,5
	30	37	26	—	1	HK3026	27.4	51.2	7.95	7 000	11 000	0.054	Table 4	JR25x30x26,5
	30	37	38	35.3	1	BK3038 ¹⁾	38.4	79.2	12.5	7 000	11 000	0.093	Table 4	JR25x30x38,5
30	37	38	—	1	HK3038 ¹⁾	38.4	79.2	12.5	7 000	11 000	0.075	Table 4	JR25x30x38,5	
35	35	42	12	—	1	HK3512	13.0	20.6	2.90	5 900	9 100	0.028	Table 4	JR30x35x17
	35	42	16	—	1	HK3516	17.4	29.9	4.60	5 900	9 100	0.037	Table 4	
	35	42	20	17.3	1	BK3520	24.5	46.8	7.40	5 900	9 100	0.065	Table 4	
	35	42	20	—	1	HK3520	24.5	46.8	7.40	5 900	9 100	0.049	Table 4	
40	40	47	12	—	1	HK4012	14.7	25.3	3.40	5 200	7 900	0.033	Table 4	JR35x40x17
	40	47	16	—	1	HK4016	18.9	34.8	5.35	5 200	7 900	0.042	Table 4	
	40	47	20	17.3	1	BK4020	25.1	50.4	8.00	5 200	7 900	0.070	Table 4	
	40	47	20	—	1	HK4020	25.1	50.4	8.00	5 200	7 900	0.060	Table 4	
45	45	52	12	—	1	HK4512	14.1	24.8	3.75	4 600	7 000	0.036	Table 4	

[Notes] 1) Drawn cup needle roller bearings with two needle roller and cage assemblies and one lubricating hole.
 2) For the recommended mounting dimensions see Table 20.

Drawn cup needle roller bearings
caged,
open ends, closed one end
metric series
HK, BK series

Shaft dia. (45) ~ 60 mm

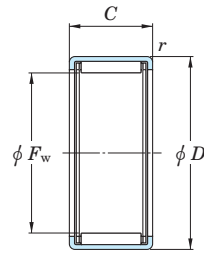

HK

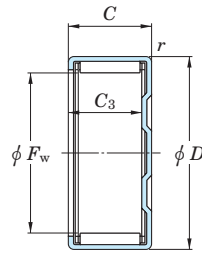

BK

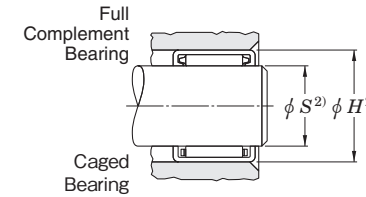

Shaft surface to be
58 HRC or equivalent

Shaft dia.	Boundary dimensions (mm)					Bearing No.	Basic load ratings (kN)		Fatigue load limit (kN)	Limiting speeds (min ⁻¹)		(Refer.) Mass (kg)	Inspection gage	Mounting inner ring (pages B466 to B475)
	<i>F_w</i>	<i>D</i>	<i>C</i> +0 -0.3	<i>C₃</i> min.	<i>r</i> min.		<i>C_r</i>	<i>C_{0r}</i>	<i>C_u</i>	Grease lub.	Oil lub.			
45	45	52	16	—	1	HK4516	19.8	38.5	5.95	4 600	7 000	0.048	Table 4	JR40x45x17
	45	52	20	17.3	1	BK4520	26.3	55.4	8.80	4 600	7 000	0.079	Table 4	JR40x45x20,5
	45	52	20	—	1	HK4520	27.2	58.2	8.80	4 600	7 000	0.059	Table 4	JR40x45x20,5
50	50	58	12	—	1	HK5012	17.0	28.7	4.40	4 100	6 300	0.045	Table 4	
	50	58	20	—	1	HK5020	30.9	62.2	8.80	4 100	6 300	0.072	Table 4	JR45x50x20
	50	58	25	—	1	HK5025	35.5	74.1	11.7	4 100	6 300	0.092	Table 4	JR45x50x25,5
55	55	63	20	—	1	HK5520	31.0	64.4	10.0	3 700	5 700	0.079	Table 4	
60	60	68	12	—	1	HK6012	18.6	34.4	5.25	3 400	5 200	0.060	Table 4	
	60	68	20	—	1	HK6020	32.5	70.2	10.9	3 400	5 200	0.090	Table 4	

[Notes] 1) Drawn cup needle roller bearings with two needle roller and cage assemblies and one lubricating hole.
 2) For the recommended mounting dimensions see Table 20.

Drawn cup needle roller bearings
caged,
open ends, closed one end
inch series
J, JH, MJ-1,
MJH-1 series

Shaft dia. 1/8 ~ 1/2 in
 (3.175 ~ 12.700 mm)

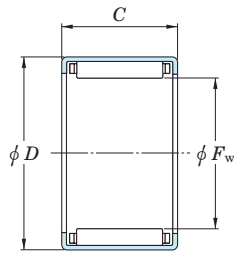

J, JH

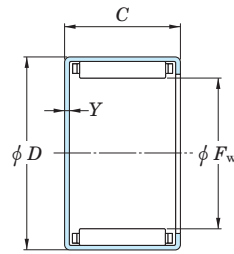

MJ-1, MJH-1

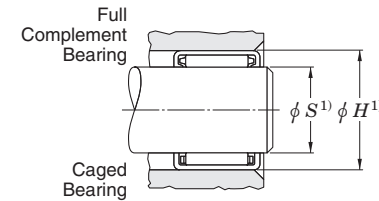

Shaft surface to be
 58 HRC or equivalent

Shaft dia. (in)	Boundary dimensions (mm)				Bearing No.		Basic load ratings (kN)		Fatigue load limit (kN)	Limiting speeds (min ⁻¹)		(Refer.) Mass (kg)		Inspection gage
	F _w	D	C +0 -0.3	Y max.	With open ends	With closed end	C _r	C _{0r}	C _u	Grease lub.	Oil lub.	With open ends	With closed end	
1/8	3.175	6.350	4.78	—	JP-23-F	—	0.90	0.61	0.100	33 000	51 000	0.001	—	Table 5
	3.175	6.350	6.35	—	JP-24-F	—	1.33	1.01	0.150	33 000	51 000	0.001	—	Table 5
5/32	3.970	7.142	4.78	—	JP-2 1/2 3F	—	0.91	0.62	0.110	31 000	47 000	0.001	—	Table 5
3/16	4.763	8.733	4.77	—	JP-33-F	—	1.07	0.73	0.120	25 000	38 000	0.001	—	Table 5
	4.763	8.733	6.35	—	JP-34-F	—	1.72	1.34	0.200	25 000	38 000	0.001	—	Table 5
	4.763	8.733	9.53	1.02	J-36	MJ-361	2.28	1.92	0.290	25 000	38 000	0.002	0.002	Table 5
1/4	6.350	11.113	7.92	1.02	J-45	MJ-451	2.21	1.74	0.300	20 000	30 000	0.003	0.003	Table 5
	6.350	11.113	11.13	1.02	J-47	MJ-471	3.40	3.01	0.450	20 000	30 000	0.004	0.004	Table 5
5/16	7.938	12.700	7.92	—	J-55	—	2.40	2.01	0.340	18 000	28 000	0.003	—	Table 5
	7.938	12.700	11.13	1.02	J-57	MJ-571	4.03	3.92	0.590	18 000	28 000	0.004	0.005	Table 5
	7.938	14.288	11.13	1.02	JH-57	MJH-571	4.65	3.76	0.570	14 000	22 000	0.006	0.007	Table 5
3/8	9.525	14.288	7.92	1.02	J-65	MJ-651	2.73	2.49	0.430	18 000	27 000	0.004	0.004	Table 5
	9.525	14.288	9.53	1.02	J-66	MJ-661	3.53	3.46	0.530	18 000	27 000	0.004	0.005	Table 5
	9.525	14.288	12.70	1.02	J-68	MJ-681	5.22	5.72	0.860	18 000	27 000	0.005	0.006	Table 5
	9.525	15.875	12.70	—	JH-68	—	6.59	6.08	0.920	13 000	20 000	0.008	—	Table 5
7/16	11.113	15.875	12.70	1.02	J-78	MJ-781	6.34	7.67	1.15	17 000	26 000	0.006	0.007	Table 5
	11.113	17.463	12.70	—	JH-78	—	7.10	6.89	1.05	13 000	19 000	0.009	—	Table 5
1/2	12.700	17.463	7.92	1.02	J-85	MJ-851	3.46	3.66	0.630	16 000	25 000	0.005	0.005	Table 5
	12.700	17.463	9.53	1.02	J-86	MJ-861	4.67	5.39	0.830	16 000	25 000	0.005	0.006	Table 5
	12.700	17.463	12.70	1.02	J-88	MJ-881	6.32	7.92	1.20	16 000	25 000	0.007	0.008	Table 5
	12.700	17.463	19.05	—	J-812	—	10.23	14.72	2.25	16 000	25 000	0.010	—	Table 5
	12.700	19.050	11.13	1.02	JH-87	MJH-871	6.39	6.20	0.950	12 000	19 000	0.009	0.010	Table 5
	12.700	19.050	12.70	1.02	JH-88	MJH-881	7.56	7.69	1.15	12 000	19 000	0.010	0.012	Table 5
	12.700	19.050	19.05	—	JH-812	—	12.32	14.41	2.25	12 000	19 000	0.015	—	Table 5

[Note] 1) For the recommended mounting dimensions see Table 21.

Drawn cup needle roller bearings
caged,
open ends, closed one end
inch series
J, JH, MJ-1,
MJH-1 series

Shaft dia. $\frac{9}{16} \sim \frac{7}{8}$ in
 (14.288 ~ 22.225 mm)

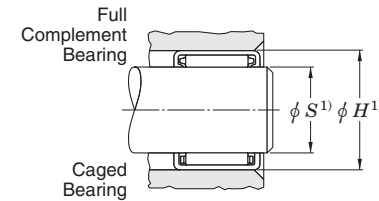
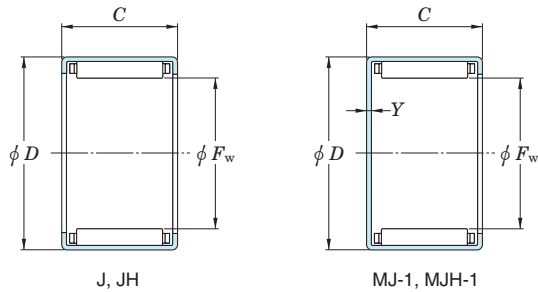

Shaft surface to be 58 HRC or equivalent

Shaft dia. (in)	Boundary dimensions (mm)				Bearing No.		Basic load ratings (kN)		Fatigue load limit (kN)	Limiting speeds (min ⁻¹)		(Refer.) Mass (kg)		Inspection gage
	F_w	D	C $^{+0}_{-0.3}$	Y max.	With open ends	With closed end	C_r	C_{Or}	C_u	Grease lub.	Oil lub.	With open ends	With closed end	
$\frac{9}{16}$	14.288	19.050	11.13	1.02	J-97	MJ-971	5.47	6.80	1.05	16 000	25 000	0.007	0.009	Table 5
	14.288	19.050	12.70	1.02	J-98	MJ-981	6.23	8.03	1.20	16 000	25 000	0.008	0.009	Table 5
	14.288	19.050	15.88	—	J-910	—	8.27	11.60	1.75	16 000	25 000	0.010	—	Table 5
	14.288	20.638	12.70	1.02	JH-98	MJH-981	7.98	8.49	1.30	12 000	18 000	0.011	0.014	Table 5
$\frac{5}{8}$	15.875	20.638	12.70	1.02	J-108	MJ-1081	6.71	9.13	1.40	13 000	21 000	0.009	0.010	Table 5
	15.875	20.638	15.88	1.02	J-1010	MJ-10101	8.80	12.94	1.95	13 000	21 000	0.010	0.013	Table 5
	15.875	20.638	19.05	1.02	J-1012	MJ-10121	11.80	18.86	2.90	13 000	21 000	0.013	0.015	Table 5
	15.875	22.212	15.88	1.02	JH-1010	MJH-10101	11.57	14.10	2.15	14 000	21 000	0.015	0.017	Table 5
	15.875	22.212	25.40	1.02	JH-1016	MJH-10161	19.79	28.11	4.35	14 000	21 000	0.024	0.028	Table 5
$\frac{11}{16}$	17.463	22.212	19.05	1.02	J-1112	MJ-11121	12.46	20.91	3.20	12 000	19 000	0.014	0.016	Table 5
	17.463	23.813	15.88	1.02	JH-1110	MJH-11101	12.05	15.21	2.30	13 000	19 000	0.016	0.019	Table 5
	17.463	23.813	19.05	—	JH-1112	—	16.10	22.20	3.10	13 000	19 000	0.019	—	Table 5
$\frac{3}{4}$	19.050	25.400	9.53	—	J-126	—	6.49	7.05	1.10	11 000	18 000	0.010	—	Table 5
	19.050	25.400	12.70	—	J-128	—	9.94	12.19	1.85	11 000	18 000	0.014	—	Table 5
	19.050	25.400	15.88	1.02	J-1210	MJ-12101	12.50	16.32	2.50	11 000	18 000	0.017	0.020	Table 5
	19.050	25.400	19.05	1.02	J-1212	MJ-12121	15.52	21.62	3.35	11 000	18 000	0.020	0.025	Table 5
	19.050	26.988	19.05	1.02	JH-1212	MJH-12121	19.08	23.58	3.70	12 000	18 000	0.026	0.031	Table 5
$\frac{13}{16}$	20.638	26.988	22.23	—	J-1314	—	19.31	29.31	4.55	10 000	16 000	0.025	—	Table 5
	20.638	28.575	19.05	1.27	JH-1312	MJH-13121	18.77	24.50	3.85	11 000	16 000	0.028	0.034	Table 5
$\frac{7}{8}$	22.225	28.575	9.53	—	J-146	—	7.20	8.43	1.30	9 700	15 000	0.012	—	Table 5
	22.225	28.575	12.70	—	J-148	—	10.94	14.50	2.20	9 700	15 000	0.015	—	Table 5
	22.225	28.575	19.05	1.02	J-1412	MJ-14121	17.88	27.18	4.20	9 700	15 000	0.024	0.028	Table 5
	22.225	28.575	25.40	1.02	J-1416	MJ-14161	23.66	38.97	6.05	9 700	15 000	0.031	0.059	Table 5
	22.225	30.163	19.05	1.27	JH-1412	MJH-14121	18.33	24.50	3.75	9 800	15 000	0.030	0.036	Table 5
	22.225	30.163	25.40	1.27	JH-1416	MJH-14161	25.40	37.37	5.80	9 800	15 000	0.040	0.048	Table 5

[Note] 1) For the recommended mounting dimensions see Table 21.

Drawn cup needle roller bearings
caged,
open ends, closed one end
inch series
J, JH, MJ-1,
MJH-1 series

Shaft dia. 1 ~ (1 3/4) in
 (25.400 ~ (44.450) mm)

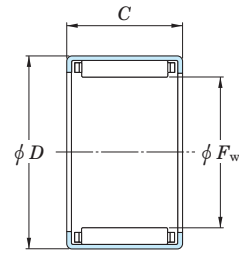

J, JH

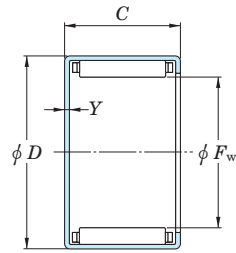

MJ-1, MJH-1

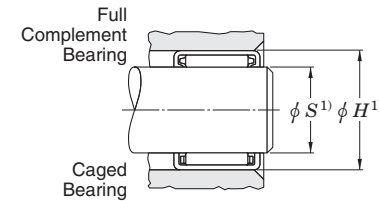

Shaft surface to be
 58 HRC or equivalent

Shaft dia. (in)	Boundary dimensions (mm)				Bearing No.		Basic load ratings (kN)		Fatigue load limit (kN)	Limiting speeds (min ⁻¹)		(Refer.) Mass (kg)		Inspection gage
	F_w	D	C _{+0 -0.3}	Y max.	With open ends	With closed end	C_r	C_{0r}	C_u	Grease lub.	Oil lub.	With open ends	With closed end	
1	25.400	31.750	19.05	—	J-1612	—	18.15	28.82	4.45	8 400	13 000	0.026	—	Table 5
	25.400	31.750	25.40	1.02	J-1616	MJ-16161	24.95	43.41	6.75	8 400	13 000	0.035	0.042	Table 5
	25.400	33.338	19.05	1.27	JH-1612	MJH-16121	20.68	29.58	4.60	8 500	13 000	0.034	0.040	Table 5
	25.400	33.338	25.40	1.27	JH-1616	MJH-16161	27.58	42.88	6.65	8 500	13 000	0.045	0.054	Table 5
1 1/8	28.575	34.925	12.70	1.02	J-188	MJ-1881	11.65	16.95	2.55	7 400	11 000	0.020	0.023	Table 5
	28.575	34.925	19.05	1.02	J-1812	MJ-18121	19.04	31.76	4.90	7 400	11 000	0.029	0.035	Table 5
	28.575	34.925	25.40	1.02	J-1816	MJ-18161	26.16	48.04	7.40	7 400	11 000	0.039	0.047	Table 5
	28.575	38.100	19.05	1.27	JH-1812	MJH-18121	23.35	31.32	4.75	7 600	12 000	0.046	0.055	Table 5
	28.575	38.100	25.40	1.27	JH-1816	MJH-18161	33.14	49.38	7.70	7 600	12 000	0.061	0.074	Table 5
	28.575	38.100	28.58	1.27	JH-1818	MJH-18181	36.30	55.16	8.60	7 600	12 000	0.069	0.082	Table 5
1 1/4	31.750	38.100	19.05	1.02	J-2012	MJ-20121	19.84	34.70	5.35	6 600	10 000	0.036	0.043	Table 5
	31.750	38.100	25.40	1.02	J-2016	MJ-20161	28.82	56.49	8.70	6 600	10 000	0.043	0.051	Table 5
	31.750	41.275	19.05	—	JH-2012	—	24.11	33.94	5.80	6 800	10 000	0.050	—	Table 5
	31.750	41.275	25.40	—	JH-2016	—	33.94	52.93	8.20	6 800	10 000	0.067	—	Table 5
	31.750	41.275	31.75	—	JH-2020	—	43.37	72.51	10.8	6 800	10 000	0.084	—	Table 5
1 3/8	34.925	41.275	12.70	1.02	J-228	MJ-2281	13.97	22.91	3.50	6 000	9 200	0.024	0.028	Table 5
	34.925	41.275	19.05	—	J-2212	—	22.82	42.97	6.65	6 000	9 200	0.035	—	Table 5
	34.925	44.450	19.05	1.27	JH-2212	MJH-22121	26.24	38.43	5.90	6 100	9 400	0.055	0.065	Table 5
	34.925	44.450	25.40	1.27	JH-2216	MJH-22161	36.52	58.72	9.20	6 100	9 400	0.073	0.087	Table 5
1 1/2	38.100	47.625	19.05	1.27	J-2412	MJ-24121	29.89	47.15	7.40	5 600	8 600	0.059	0.094	Table 5
	38.100	47.625	25.40	1.27	J-2416	MJ-24161	39.32	66.72	10.4	5 600	8 600	0.079	0.094	Table 5
	38.100	47.625	31.75	—	J-2420	—	49.38	89.85	14.0	5 600	8 600	0.099	—	Table 5
1 5/8	41.275	50.800	15.88	—	J-2610	—	26.11	40.97	6.25	5 100	7 900	0.053	—	Table 5
	41.275	50.800	25.40	1.27	J-2616	M-26161	39.28	68.95	10.8	5 100	7 900	0.085	0.101	Table 5
1 3/4	44.450	53.975	19.05	1.27	J-2812	MJ-28121	29.58	49.38	7.45	4 700	7 300	0.068	0.081	Table 5

[Note] 1) For the recommended mounting dimensions see Table 21.

Drawn cup needle roller bearings
caged,
open ends, closed one end
inch series
J, JH, MJ-1,
MJH-1 series

Shaft dia. (1 3/4) ~ 2 3/4 in
 ((44.450) ~ 69.850 mm)

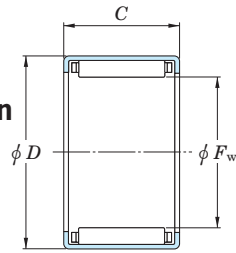

J, JH

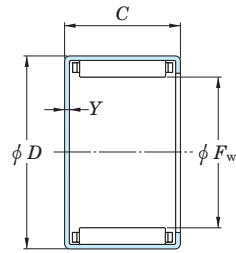

MJ-1, MJH-1

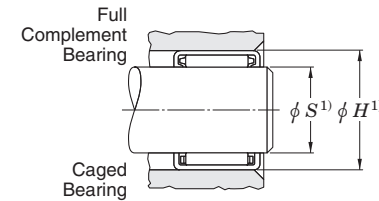

Shaft surface to be
 58 HRC or equivalent

Shaft dia. (in)	Boundary dimensions (mm)				Bearing No.		Basic load ratings (kN)		Fatigue load limit (kN)	Limiting speeds (min ⁻¹)		(Refer.) Mass (kg)		Inspection gage
	F _w	D	C +0 -0.3	Y max.	With open ends	With closed end	C _r	C _{0r}	C _u	Grease lub.	Oil lub.	With open ends	With closed end	
1 3/4	44.450	53.975	25.40	1.27	J-2816	MJ-28161	40.08	72.95	11.4	4 700	7 300	0.091	0.108	Table 5
	44.450	53.975	38.10	1.27	J-2824	MJ-28241	59.61	121.88	18.9	4 700	7 300	0.136	0.162	Table 5
1 7/8	47.625	57.150	25.40	1.27	J-3016	MJ-30161	41.10	76.06	11.9	4 400	6 800	0.097	0.115	Table 5
2	50.800	60.325	25.40	1.27	J-3216	MJ-32161	42.39	81.40	12.7	4 100	6 300	0.103	0.137	Table 5
2 1/4	57.150	66.675	19.05	—	J-3612	—	35.41	65.83	10.0	3 600	5 600	0.086	—	Table 5
	57.150	66.675	25.40	—	J-3616	—	46.26	92.52	14.4	3 600	5 600	0.114	—	Table 5
2 3/4	69.850	79.375	19.05	—	J-4412	—	36.25	72.95	11.3	2 900	4 500	0.103	—	Table 5

[Note] 1) For the recommended mounting dimensions see Table 21.

**Heavy-duty needle roller bearings
without inner rings
metric series
NK, NKS, RNA48, RNA49
RNA69, NKTN series**

Shaft dia. 5 ~ (17) mm

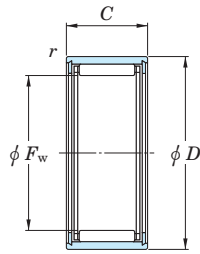

NK ($\phi F_w \leq 10$)

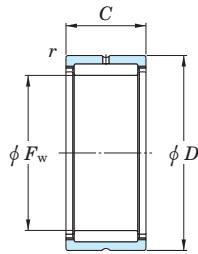

NK ($\phi F_w \geq 12$), NKS, RNA48,
RNA49, RNA69 ($\phi F_w \leq 35$)

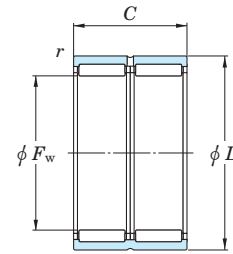

RNA69
($\phi F_w \geq 40$)

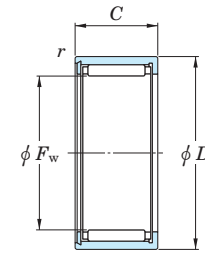

NKTN

Shaft dia. (17) ~ 25 mm

Shaft dia.	Boundary dimensions (mm)				Bearing No.	Basic load ratings (kN)		Fatigue load limit (kN) C_u	Limiting speeds (min ⁻¹)		(Refer.) Mass (kg)
	F_w	D	C	$r_{min.}$		C_r	C_{0r}		Grease lub.	Oil lub.	
5	5	10	10	0.2	NK5/10TN	2.18	1.71	0.260	31 000	47 000	0.004
	5	10	12	0.2	NK5/12TN	3.04	2.63	0.400	31 000	47 000	0.004
6	6	12	10	0.2	NK6/10	3.19	2.90	0.420	29 000	44 000	0.005
	6	12	12	0.2	NK6/12TN	3.07	2.74	0.420	29 000	44 000	0.006
7	7	14	10	0.3	NK7/10TN	2.74	2.44	0.370	28 000	42 000	0.007
	7	14	12	0.3	NK7/12TN	3.40	3.22	0.490	28 000	42 000	0.009
8	8	15	12	0.3	NK8/12	4.57	4.89	0.740	26 000	41 000	0.011
	8	15	12	0.3	NK8/12ASR1	4.57	4.89	0.740	26 000	41 000	0.011
	8	15	16	0.3	NK8/16	5.22	5.78	0.880	26 000	41 000	0.013
9	9	16	12	0.3	NK9/12	4.27	4.60	0.700	26 000	40 000	0.012
	9	16	16	0.3	NK9/16	5.57	6.47	0.980	26 000	40 000	0.015
10	10	17	12	0.3	NK10/12	5.40	6.43	0.980	25 000	39 000	0.013
	10	17	16	0.3	NK10/16TN	5.30	6.27	0.940	25 000	39 000	0.015
12	12	19	12	0.3	NK12/12	6.86	7.60	1.15	19 000	30 000	0.013
	12	19	16	0.3	NK12/16	6.78	9.03	1.40	24 000	37 000	0.018
14	14	22	13	0.3	RNA4900	9.39	10.3	1.55	16 000	24 000	0.018
	14	22	16	0.3	NK14/16	12.4	14.8	2.25	16 000	24 000	0.023
	14	22	20	0.3	NK14/20	14.7	18.4	2.90	16 000	24 000	0.028
15	15	23	16	0.3	NK15/16	12.4	15.0	2.30	15 000	24 000	0.024
	15	23	20	0.3	NK15/20	14.7	18.6	2.95	15 000	24 000	0.031
16	16	24	13	0.3	RNA4901	10.5	12.3	1.85	18 000	28 000	0.020
	16	24	16	0.3	NK16/16	15.4	20.2	2.50	18 000	28 000	0.025
	16	24	20	0.3	NK16/20	16.1	21.3	3.20	18 000	28 000	0.036
	16	24	22	0.3	RNA6901	16.1	21.3	3.30	18 000	28 000	0.036
17	17	25	16	0.3	NK17/16	13.6	17.5	2.70	17 000	27 000	0.027

Shaft dia.	Boundary dimensions (mm)				Bearing No.	Basic load ratings (kN)		Fatigue load limit (kN) C_u	Limiting speeds (min ⁻¹)		(Refer.) Mass (kg)
	F_w	D	C	$r_{min.}$		C_r	C_{0r}		Grease lub.	Oil lub.	
17	17	25	20	0.3	NK17/20	15.4	20.4	3.25	17 000	27 000	0.034
18	18	26	16	0.3	NK18/16	13.6	17.7	2.70	16 000	25 000	0.028
	18	26	20	0.3	NK18/20	16.1	22.0	3.50	16 000	25 000	0.035
19	19	27	16	0.3	NK19/16	14.1	19.0	2.90	15 000	24 000	0.029
	19	27	20	0.3	NK19/20	18.8	23.6	3.75	15 000	24 000	0.037
	19	30	16	0.3	NKS18	15.9	16.2	2.45	17 000	26 000	0.045
20	20	28	13	0.3	RNA4902	11.8	15.3	2.35	14 000	22 000	0.023
	20	28	16	0.3	NK20/16	14.1	19.1	2.90	14 000	22 000	0.030
	20	28	20	0.3	NK20/20	17.5	25.3	4.00	14 000	22 000	0.038
	20	28	23	0.3	RNA6902	18.4	26.9	4.20	14 000	22 000	0.042
20	20	32	20	0.6	NKS20	24.4	26.7	4.30	15 000	24 000	0.058
21	21	29	16	0.3	NK21/16	15.3	21.6	3.30	14 000	21 000	0.032
	21	29	20	0.3	NK21/20	18.1	26.9	4.25	14 000	21 000	0.040
22	22	30	13	0.3	RNA4903	12.2	16.4	2.50	13 000	20 000	0.025
	22	30	16	0.3	NK22/16	15.2	21.7	3.30	13 000	20 000	0.033
	22	30	20	0.3	NK22/20	18.0	27.0	4.30	13 000	20 000	0.041
	22	30	23	0.3	RNA6903	19.8	30.6	4.75	13 000	20 000	0.056
22	22	35	20	0.6	NKS22	22.9	27.1	4.30	14 000	21 000	0.069
24	24	32	16	0.3	NK24/16	16.2	24.3	3.70	12 000	18 000	0.035
	24	32	20	0.3	NK24/20	19.3	30.3	4.80	12 000	18 000	0.045
	24	37	20	0.6	NKS24	29.1	32.8	5.30	13 000	20 000	0.073
25	25	33	16	0.3	NK25/16	16.1	24.4	3.75	11 000	17 000	0.037
	25	33	20	0.3	NK25/20	19.1	30.4	4.80	11 000	17 000	0.047
	25	37	17	0.3	RNA4904	21.3	25.5	3.95	12 000	18 000	0.061
	25	37	30	0.3	RNA6904	36.6	51.0	7.95	12 000	18 000	0.091
	25	38	20	0.6	NKS25	29.1	33.0	5.30	12 000	19 000	0.076

**Heavy-duty needle roller bearings
without inner rings
metric series
NK, NKS, RNA48, RNA49
RNA69, NKTN series**

Shaft dia. 26 ~ 37 mm

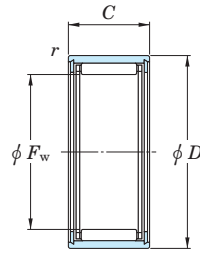

NK ($\phi F_w \leq 10$)

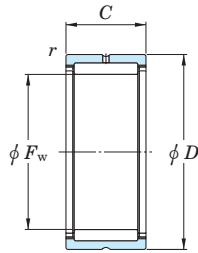

NK ($\phi F_w \geq 12$), NKS, RNA48,
RNA49, RNA69 ($\phi F_w \leq 35$)

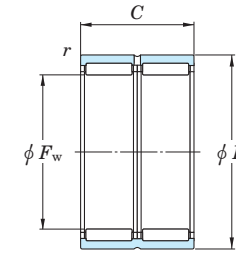

RNA69
($\phi F_w \geq 40$)

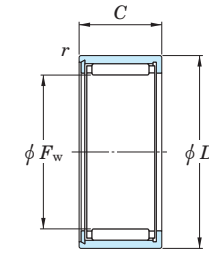

NKTN

Shaft dia. 38 ~ 52 mm

Shaft dia.	Boundary dimensions (mm)				Bearing No.	Basic load ratings (kN)		Fatigue load limit (kN) C_u	Limiting speeds (min^{-1})		(Refer.) Mass (kg)
	F_w	D	C	r_{min}		C_r	C_{0r}		Grease lub.	Oil lub.	
26	26	34	16	0.3	NK26/16	16.6	25.7	3.95	11 000	17 000	0.039
	26	34	20	0.3	NK26/20	19.7	32.0	5.05	11 000	17 000	0.048
28	28	37	20	0.3	NK28/20	22.6	34.4	5.50	10 000	16 000	0.057
	28	37	30	0.3	NK28/30	29.0	53.8	8.30	10 000	16 000	0.088
	28	39	17	0.3	RNA49/22	23.3	29.6	4.55	10 000	16 000	0.059
	28	39	30	0.3	RNA69/22	30.6	50.7	3.95	10 000	16 000	0.107
	28	42	20	0.6	NKS28	30.3	38.4	6.15	11 000	16 000	0.094
29	29	38	20	0.3	NK29/20	23.4	36.4	5.80	9 800	15 000	0.059
	29	38	30	0.3	NK29/30	29.8	56.4	8.70	9 700	15 000	0.090
30	30	40	20	0.3	NK30/20	24.2	38.3	6.10	9 500	15 000	0.071
	30	40	30	0.3	NK30/30	34.7	61.0	9.45	9 500	15 000	0.107
	30	42	17	0.3	RNA4905	24.3	31.7	4.90	9 700	15 000	0.071
	30	42	30	0.3	RNA6905	39.7	59.6	9.30	9 700	15 000	0.127
	30	45	20	0.6	NKS30	34.3	42.8	6.85	9 900	15 000	0.114
32	32	42	20	0.3	NK32/20	24.8	40.4	6.45	8 800	14 000	0.074
	32	42	30	0.3	NK32/30	35.6	64.3	9.95	8 800	14 000	0.112
	32	45	17	0.3	RNA49/28	25.1	33.8	5.20	9 000	14 000	0.080
	32	45	30	0.3	RNA69/28	43.2	62.5	9.75	9 100	14 000	0.140
	32	47	22	0.6	NKS32	36.0	46.2	7.40	9 200	14 000	0.120
35	35	45	20	0.3	NK35/20	26.1	44.4	7.05	8 000	12 000	0.081
	35	45	30	0.3	NK35/30	37.4	70.6	11.0	8 000	12 000	0.122
	35	47	18	0.3	RNA4906	25.9	36.0	5.55	8 200	13 000	0.081
	35	47	30	0.3	RNA6906	42.6	68.2	10.6	8 200	13 000	0.148
	35	50	22	0.6	NKS35	37.5	49.9	8.00	8 400	13 000	0.130
37	37	47	20	0.3	NK37/20	26.6	46.4	7.40	7 600	12 000	0.084
	37	47	30	0.3	NK37/30	38.2	73.9	11.5	7 600	12 000	0.128
	37	52	22	0.6	NKS37	39.0	53.4	8.55	7 900	12 000	0.134

Shaft dia.	Boundary dimensions (mm)				Bearing No.	Basic load ratings (kN)		Fatigue load limit (kN) C_u	Limiting speeds (min^{-1})		(Refer.) Mass (kg)
	F_w	D	C	r_{min}		C_r	C_{0r}		Grease lub.	Oil lub.	
38	38	48	20	0.3	NK38/20	21.7	40.9	6.40	7 300	11 000	0.087
	38	48	30	0.3	NK38/30	31.9	67.0	10.4	7 300	11 000	0.131
40	40	50	20	0.3	NK40/20	27.8	50.4	8.05	7 000	11 000	0.089
	40	50	30	0.3	NK40/30	40.0	80.2	12.4	7 000	11 000	0.137
	40	52	20	0.6	RNA49/32	32.0	49.3	7.85	7 100	11 000	0.100
	40	52	36	0.6	RNA69/32	48.6	84.5	26.1	7 100	11 000	0.185
	40	55	22	0.6	NKS40	40.3	57.0	9.15	7 200	11 000	0.140
42	42	52	20	0.3	NK42/20	28.3	52.4	8.35	6 600	10 000	0.085
	42	52	30	0.3	NK42/30	40.7	83.5	13.0	6 600	10 000	0.141
	42	55	20	0.6	RNA4907	32.8	51.7	8.25	6 700	10 000	0.114
	42	55	36	0.6	RNA6907	49.9	88.7	13.7	6 700	10 000	0.218
43	43	53	20	0.3	NK43/20	29.0	54.4	8.65	6 400	9 900	0.096
	43	53	30	0.3	NK43/30	41.6	86.6	13.4	6 400	9 900	0.134
	43	58	22	0.6	NKS43	41.6	60.7	9.75	6 700	10 000	0.150
45	45	55	20	0.3	NK45/20	29.5	56.4	9.00	6 100	9 400	0.100
	45	55	30	0.3	NK45/30	42.3	89.8	13.9	6 100	9 400	0.151
	45	60	22	0.6	NKS45	43.0	64.2	10.3	6 400	9 800	0.156
47	47	57	20	0.3	NK47/20	30.0	58.5	9.30	5 900	9 000	0.104
	47	57	30	0.3	NK47/30	43.0	93.1	14.4	5 900	9 000	0.158
48	48	62	22	0.6	RNA4908	44.2	67.8	10.9	5 900	9 100	0.154
	48	62	40	0.6	RNA6908	70.8	124	19.8	5 900	9 100	0.300
50	50	62	25	0.3	NK50/25	40.7	79.3	12.5	5 500	8 500	0.171
	50	62	35	0.6	NK50/35	55.0	117	18.2	5 500	8 500	0.242
	50	65	22	1	NKS50	45.5	71.3	11.4	5 700	8 700	0.170
52	52	68	22	0.6	RNA4909	46.8	74.8	12.0	5 400	8 400	0.201
	52	68	40	0.6	RNA6909	74.7	137	21.7	5 400	8 400	0.392

**Heavy-duty needle roller bearings
without inner rings
metric series
NK, NKS, RNA48, RNA49
RNA69, NKTN series**

Shaft dia. 55 ~ (75) mm

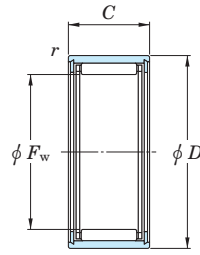

NK ($\phi F_w \leq 10$)

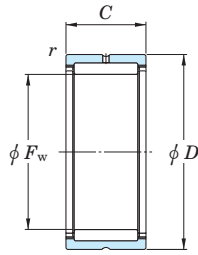

NK ($\phi F_w \geq 12$), NKS, RNA48,
RNA49, RNA69 ($\phi F_w \leq 35$)

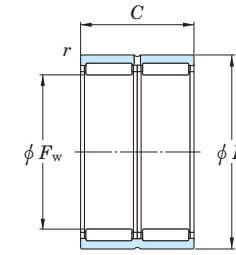

RNA69
($\phi F_w \geq 40$)

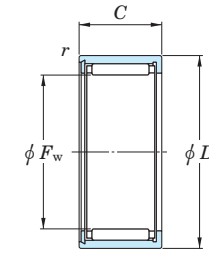

NKTN

Shaft dia. (75) ~ 110 mm

Shaft dia.	Boundary dimensions (mm)				Bearing No.	Basic load ratings (kN)		Fatigue load limit (kN) C_u	Limiting speeds (min ⁻¹)		(Refer.) Mass (kg)
	F_w	D	C	$r_{min.}$		C_r	C_{0r}		Grease lub.	Oil lub.	
55	55	68	25	0.6	NK55/25	46.1	87.3	13.9	5 000	7 800	0.207
	55	68	35	0.6	NK55/35	62.3	129	20.0	5 000	7 800	0.293
	55	72	22	1	NKS55	47.9	78.4	12.6	5 100	7 900	0.225
58	58	72	22	0.6	RNA4910	48.9	82.0	13.2	4 800	7 400	0.179
	58	72	40	0.6	RNA6910	75.7	144	22.8	4 800	7 400	0.364
60	60	72	25	0.6	NK60/25	44.3	94.0	14.9	4 400	7 000	0.202
	60	72	35	0.6	NK60/35	59.9	139	21.5	4 400	7 000	0.286
	60	80	28	1.1	NKS60	66.9	103	16.5	4 800	7 300	0.337
63	63	80	25	1	RNA4911	62.0	107	17.1	4 500	6 900	0.285
	63	80	45	1	RNA6911	94.2	172	27.8	4 500	6 900	0.540
65	65	78	25	0.6	NK65/25	48.2	97.7	15.5	4 200	6 500	0.257
	65	78	35	0.6	NK65/35	65.2	144	22.4	4 200	6 500	0.298
	65	85	28	1.1	NKS65	71.0	114	18.3	4 200	6 700	0.362
	65	85	45	1	RNA6912	99.3	189	30.5	4 100	6 300	0.546
68	68	82	25	0.6	NK68/25	49.0	101	16.1	4 000	6 200	0.287
	68	82	35	0.6	NK68/35	66.2	149	23.2	4 000	6 200	0.350
	68	85	25	1	RNA4912	64.8	116	18.6	4 100	6 300	0.304
	68	85	45	1	RNA6912	99.3	189	30.5	4 100	6 300	0.546
70	70	85	25	0.6	NK70/25	43.6	87.9	16.6	3 900	6 000	0.298
	70	85	35	0.6	NK70/35	62.2	139	24.0	3 900	6 000	0.411
	70	90	28	1.1	NKS70	72.6	120	19.3	4 000	6 200	0.383
72	72	90	25	1	RNA4913	66.0	121	19.4	3 900	5 900	0.346
	72	90	45	1	RNA6913	107	213	34.5	3 900	5 900	0.679
73	73	90	25	0.6	NK73/25	61.5	119	19.0	3 800	5 800	0.320
	73	90	35	0.6	NK73/35	82.5	173	27.1	3 800	5 800	0.450
75	75	92	25	0.6	NK75/25	43.7	90.2	19.0	3 600	5 600	0.364
	75	92	35	0.6	NK75/35	60.9	138	27.1	3 600	5 600	0.518

Shaft dia.	Boundary dimensions (mm)				Bearing No.	Basic load ratings (kN)		Fatigue load limit (kN) C_u	Limiting speeds (min ⁻¹)		(Refer.) Mass (kg)	
	F_w	D	C	$r_{min.}$		C_r	C_{0r}		Grease lub.	Oil lub.		
75	75	95	28	1.1	NKS75	76.5	132	21.1	3 700	5 800	0.413	
80	80	95	25	1	NK80/25	65.0	131	21.0	3 400	5 300	0.331	
	80	95	35	1	NK80/35	79.7	184	28.7	3 400	5 300	0.380	
	80	100	30	1	RNA4914	86.3	157	25.1	3 500	5 400	0.502	
80	80	100	54	1	RNA6914	137	286	45.7	3 500	5 400	0.946	
	85	85	105	25	1	NK85/25	76.4	137	22.2	3 300	5 000	0.506
		85	105	30	1	RNA4915	92.4	175	28.0	3 300	5 000	0.528
85		105	35	1	NK85/35	108	214	34.7	3 300	5 000	0.610	
85	85	105	54	1	RNA6915	143	308	49.3	3 300	5 000	1.020	
	90	90	110	25	1	NK90/25	79.5	147	23.8	3 100	4 700	0.450
		90	110	30	1	RNA4916	91.5	176	28.1	3 100	4 700	0.556
90		110	35	1	NK90/35	113	230	36.1	3 100	4 700	0.745	
90		110	54	1	RNA6916	126	320	50.8	3 100	4 700	1.050	
95	95	115	26	1	NK95/26	49.3	114	24.6	2 800	4 400	0.572	
	95	115	36	1	NK95/36	114	238	37.3	2 900	4 500	0.803	
100	100	120	26	1	NK100/26	83.6	163	25.8	2 800	4 200	0.530	
	100	120	35	1.1	RNA4917	110	230	36.0	2 800	4 200	0.715	
	100	120	36	1	NK100/36	118	254	39.1	2 800	4 200	0.658	
	100	120	63	1.1	RNA6917	150	416	63.0	2 800	4 200	1.350	
105	105	125	26	1	NK105/26	52.2	127	19.9	2 600	3 900	0.595	
	105	125	35	1.1	RNA4918	114	245	37.8	2 600	4 000	0.746	
	105	125	63	1.1	RNA6918	154	437	66.0	2 600	4 000	1.500	
110	110	130	30	1.1	NK110/30	103	220	33.6	2 500	3 800	0.660	
	110	130	35	1.1	RNA4919	115	253	38.4	2 500	3 800	0.777	
	110	130	40	1.1	NK110/40	132	301	45.7	2 500	3 800	0.900	
	110	130	63	1.1	RNA6919	158	458	68.8	2 500	3 800	1.470	

**Heavy-duty needle roller bearings
without inner rings
metric series
NK, NKS, RNA48, RNA49
RNA69, NKTN series**

Shaft dia. 115 ~ 175 mm

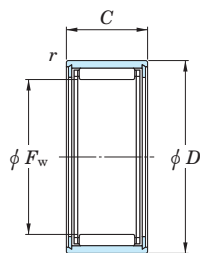

NK ($\phi F_w \leq 10$)

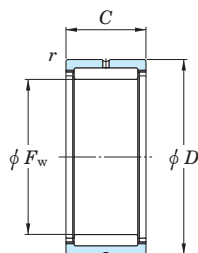

NK ($\phi F_w \geq 12$), NKS, RNA48,
RNA49, RNA69 ($\phi F_w \leq 35$)

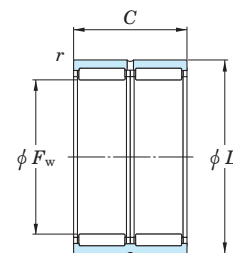

RNA69
($\phi F_w \geq 40$)

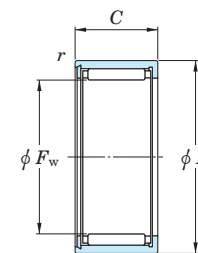

NKTN

Shaft dia.	Boundary dimensions (mm)				Bearing No.	Basic load ratings (kN)		Fatigue load limit (kN) C_u	Limiting speeds (min ⁻¹)		(Refer.) Mass (kg)
	F_w	D	C	$r_{min.}$		C_r	C_{0r}		Grease lub.	Oil lub.	
115	115	140	40	1.1	RNA4920	139	296	43.9	2 400	3 700	1.220
120	120	140	30	1	RNA4822	90.3	230	33.7	2 300	3 500	0.785
125	125	150	40	1.1	RNA4922	147	325	47.0	2 200	3 400	1.320
130	130	150	30	1	RNA4824	94.1	249	35.7	2 100	3 200	0.850
135	135	165	45	1.1	RNA4924	177	407	58.5	2 000	3 100	1.980
145	145	165	35	1	RNA4826	112	323	44.8	1 900	2 900	1.100
150	150	180	50	1.5	RNA4926	201	495	68.7	1 800	2 800	2.420
155	155	175	35	1.1	RNA4828	116	346	47.1	1 700	2 700	1.170
160	160	190	50	1.5	RNA4928	214	549	74.8	1 700	2 600	2.560
165	165	190	40	1.1	RNA4830	142	402	53.5	1 600	2 500	1.540
175	175	200	40	1.1	RNA4832	146	425	55.6	1 500	2 400	1.910

Heavy-duty needle roller bearings

inch series

HJ type

Shaft dia. $\frac{5}{8} \sim (1 \frac{3}{4})$ in
(15.875 ~ (44.450) mm)

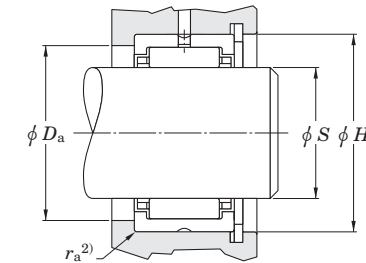
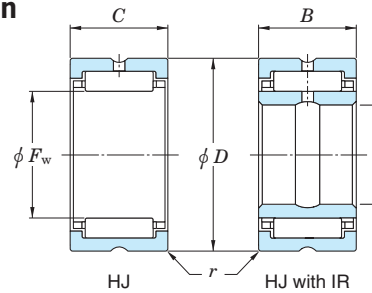

Shaft surface to be 58 HRC or equivalent

Shaft dia. (in)	Boundary dimensions (mm)				Bearing No.	Used with inner ring No. 1)	Basic load ratings (kN)		Fatigue load limit (kN) Cu	Limiting speeds (min ⁻¹)		(Refer.) Mass (kg)	Recommended dimensions								Shoulder dia. Da ±0.38								
	Fw	D	C (B)	r min.			Cr	Cor		Grease lub.	Oil lub.		Clearance fit				Tight transition fit												
													S (h6) max.	S (h6) min.	H (H7) max.	H (H7) min.	S (f6) max.	S (f6) min.	H (N7) max.	H (N7) min.									
5/8	15.875	28.575	19.050	0.64	HJ-101812	IR-061012	19.3	20.7	3.25	20 000	30 000	0.050	15.875	15.865	28.595	28.575	15.860	15.850	28.567	28.547	23.83								
3/4	19.050	31.750	19.050	1.02	HJ-122012	IR-081212	20.7	23.3	3.65	16 000	25 000	0.059	19.050	19.037	31.775	31.750	19.030	19.017	31.742	31.717	26.97								
	19.050	31.750	25.400	1.02									HJ-122016	IR-081216	27.5	33.7	5.30	16 000	25 000	0.077		19.050	19.037	31.775	31.750	19.030	19.017	31.742	31.717
7/8	22.225	34.925	19.050	1.02	HJ-142212	IR-101412	23	27.9	4.35	13 000	21 000	0.064	22.225	22.212	34.950	34.925	22.205	22.192	34.917	34.892	30.18								
	22.225	34.925	25.400	1.02									HJ-142216	IR-101416	30.7	40.3	6.35	13 000	21 000	0.086		22.225	22.212	34.950	34.925	22.205	22.192	34.917	34.892
1	25.400	38.100	19.050	1.02	HJ-162412	IR-121612	25.3	32.5	5.10	12 000	18 000	0.073	25.400	25.387	38.125	38.100	25.380	25.367	38.092	38.067	33.32								
	25.400	38.100	25.400	1.02									HJ-162416	IR-121616	33.6	47.2	7.40	12 000	18 000	0.095		25.400	25.387	38.125	38.100	25.380	25.367	38.092	38.067
	25.400	38.100	25.400	1.02									HJ-162416	IR-131616	33.6	47.2	7.40	12 000	18 000	0.095		25.400	25.387	38.125	38.100	25.380	25.367	38.092	38.067
1 1/8	28.575	41.275	25.400	1.02	HJ-182616	IR-141816	36.3	53.8	8.45	10 000	16 000	0.104	28.575	28.562	41.300	41.275	28.555	28.542	41.267	41.242	36.53								
	28.575	41.275	25.400	1.02									HJ-182616	IR-151816	36.3	53.8	8.45	10 000	16 000	0.104		28.575	28.562	41.300	41.275	28.555	28.542	41.267	41.242
	28.575	41.275	31.750	1.02									HJ-182620	IR-141820	44.9	70.3	10.9	10 000	16 000	0.132		28.575	28.562	41.300	41.275	28.555	28.542	41.267	41.242
	28.575	41.275	31.750	1.02									HJ-182620	IR-151820	44.9	70.3	10.9	10 000	16 000	0.132		28.575	28.562	41.300	41.275	28.555	28.542	41.267	41.242
1 1/4	31.750	44.450	25.400	1.02	HJ-202816	IR-162016	37.4	57.4	9.00	9 100	14 000	0.113	31.750	31.735	44.475	44.450	31.725	31.709	44.442	44.417	39.67								
	31.750	44.450	31.750	1.02									HJ-202820	IR-162020	46.3	75.2	11.7	9 100	14 000	0.145		31.750	31.735	44.475	44.450	31.725	31.709	44.442	44.417
1 3/8	34.925	47.625	25.400	1.02	HJ-223016	IR-182216	39.8	64.1	10.1	8 200	13 000	0.127	34.925	34.910	47.650	47.625	34.900	34.884	47.617	47.592	42.88								
	34.925	47.625	31.750	1.02									HJ-223020	IR-182220	49.4	84.1	13.0	8 200	13 000	0.159		34.925	34.910	47.650	47.625	34.900	34.884	47.617	47.592
1 1/2	38.100	52.388	25.400	1.52	HJ-243316	IR-202416	47.6	72.5	11.4	7 600	12 000	0.154	38.100	38.085	52.418	52.388	38.075	38.059	52.380	52.349	47.63								
	38.100	52.388	31.750	1.52									HJ-243320	IR-192420	58.7	95.2	14.9	7 600	12 000	0.195		38.100	38.085	52.418	52.388	38.075	38.059	52.380	52.349
	38.100	52.388	31.750	1.52									HJ-243320	IR-202420	58.7	95.2	14.9	7 600	12 000	0.195		38.100	38.085	52.418	52.388	38.075	38.059	52.380	52.349
1 5/8	41.275	55.563	25.400	1.52	HJ-263516	IR-212616	48.5	76.5	12.1	7 000	11 000	0.163	41.275	41.260	55.593	55.563	41.250	41.234	55.555	55.524	50.80								
	41.275	55.563	31.750	1.52									HJ-263520	IR-212620	60.1	100.5	15.7	7 000	11 000	0.209		41.275	41.260	55.593	55.563	41.250	41.234	55.555	55.524
	41.275	55.563	31.750	1.52									HJ-263520	IR-222620	60.1	100.5	15.7	7 000	11 000	0.209		41.275	41.260	55.593	55.563	41.250	41.234	55.555	55.524
1 3/4	44.450	58.738	25.400	1.52	HJ-283716	IR-232816	49.8	81.0	12.8	6 400	9 900	0.177	44.450	44.435	58.768	58.738	44.425	44.409	58.730	58.699	53.98								
	44.450	58.738	25.400	1.52									HJ-283716	IR-242816	49.8	81.0	12.8	6 400	9 900	0.177		44.450	44.435	58.768	58.738	44.425	44.409	58.730	58.699
	44.450	58.738	31.750	1.52									HJ-283720	IR-222820	61.8	106	16.6	6 400	9 900	0.222		44.450	44.435	58.768	58.738	44.425	44.409	58.730	58.699

[Notes] 1) See pages B478 to B480 for inch series inner rings. Order inner rings separately.

2) ra max is equal to the minimum bearing chamfer (r min) at unmarked end.

Heavy-duty needle roller bearings

inch series

HJ type

Shaft dia. (1 3/4) ~ 3 1/2 in
((44.450) ~ 88.900 mm)

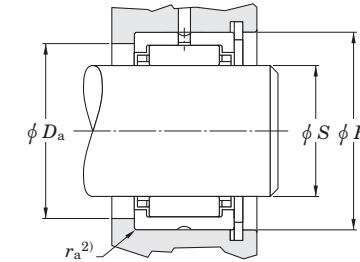
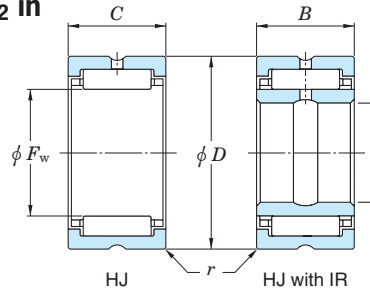

Shaft surface to be 58 HRC or equivalent

Shaft dia. (in)	Boundary dimensions (mm)				Bearing No.	Used with inner ring No. 1)	Basic load ratings (kN)		Fatigue load limit (kN) Cu	Limiting speeds (min ⁻¹)		(Refer.) Mass (kg)	Recommended dimensions								Shoulder dia. Da ±0.38
	Fw	D	C (B)	r min.			Cr	C0r		Grease lub.	Oil lub.		Clearance fit				Tight transition fit				
													S (h6) max.	S (h6) min.	H (H7) max.	H (H7) min.	S (f6) max.	S (f6) min.	H (N7) max.	H (N7) min.	
1 3/4	44.450	58.738	31.750	1.52	HJ-283720	IR-232820	61.8	106	16.6	6 400	9 900	0.222	44.450	44.435	58.768	58.738	44.425	44.409	58.730	58.699	53.98
	44.450	58.738	31.750	1.52	HJ-283720	IR-242820	61.8	106	16.6	6 400	9 900	0.222	44.450	44.435	58.768	58.738	44.425	44.409	58.730	58.699	53.98
1 7/8	47.625	61.913	31.750	1.52	HJ-303920	IR-253020	65.4	117	18.1	6 000	9 200	0.236	47.625	47.610	61.943	61.913	47.600	47.584	61.905	61.874	57.15
2	50.800	65.088	25.400	1.52	HJ-324116	IR-273216	53.8	93.0	14.7	5 600	8 600	0.200	50.800	50.782	65.118	65.088	50.770	50.752	65.080	65.049	60.33
	50.800	65.088	31.750	1.52	HJ-324120	IR-243220	66.7	122	19.1	5 600	8 600	0.249	50.800	50.782	65.118	65.088	50.770	50.752	65.080	65.049	60.33
	50.800	65.088	31.750	1.52	HJ-324120	IR-253220	66.7	122	19.1	5 600	8 600	0.249	50.800	50.782	65.118	65.088	50.770	50.752	65.080	65.049	60.33
	50.800	65.088	31.750	1.52	HJ-324120	IR-263220	66.7	122	19.1	5 600	8 600	0.249	50.800	50.782	65.118	65.088	50.770	50.752	65.080	65.049	60.33
	50.800	65.088	31.750	1.52	HJ-324120	IR-273220	66.7	122	19.1	5 600	8 600	0.249	50.800	50.782	65.118	65.088	50.770	50.752	65.080	65.049	60.33
2 1/4	57.150	76.200	38.100	1.52	HJ-364824	IR-283624	89.9	164	25.7	5 000	7 600	0.458	57.150	57.132	76.230	76.200	57.120	57.102	76.192	76.162	68.28
	57.150	76.200	44.450	1.52	HJ-364828	IR-283628	104	198	30.8	5 000	7 600	0.531	57.150	57.132	76.230	76.200	57.120	57.102	76.192	76.162	68.28
2 1/2	63.500	82.550	38.100	2.03	HJ-405224	IR-314024	97.0	187	29.4	4 400	6 800	0.499	63.500	63.482	82.586	82.550	63.470	63.452	82.537	82.502	74.63
	63.500	82.550	38.100	2.03	HJ-405224	IR-324024	97.0	187	29.4	4 400	6 800	0.499	63.500	63.482	82.586	82.550	63.470	63.452	82.537	82.502	74.63
	63.500	82.550	44.450	2.03	HJ-405228	IR-314028	97.0	187	35.2	4 400	6 800	0.499	63.500	63.482	82.586	82.550	63.470	63.452	82.537	82.502	74.63
	63.500	82.550	44.450	2.03	HJ-405228	IR-324028	97.0	187	35.2	4 400	6 800	0.499	63.500	63.482	82.586	82.550	63.470	63.452	82.537	82.502	74.63
2 3/4	69.850	88.900	25.400	2.03	HJ-445616	—	67.2	120	19.1	4 000	6 200	0.363	69.850	69.832	88.936	88.900	69.820	69.802	88.887	88.852	80.98
	69.850	88.900	38.100	2.03	HJ-445624	IR-364424	101	203	31.9	4 000	6 200	0.544	69.850	69.832	88.936	88.900	69.820	69.802	88.887	88.852	80.98
	69.850	88.900	44.450	2.03	HJ-445628	IR-354428	117	245	38.2	4 000	6 200	0.635	69.850	69.832	88.936	88.900	69.820	69.802	88.887	88.852	80.98
	69.850	88.900	44.450	2.03	HJ-445628	IR-364428	117	245	38.2	4 000	6 200	0.635	69.850	69.832	88.936	88.900	69.820	69.802	88.887	88.852	80.98
3	76.200	95.250	38.100	2.03	HJ-486024	IR-404824	107	226	35.5	3 700	5 600	0.585	76.200	76.182	95.286	95.250	76.170	76.152	95.237	95.202	87.33
	76.200	95.250	44.450	2.03	HJ-486028	IR-384828	124	273	42.5	3 700	5 600	0.685	76.200	76.182	95.286	95.250	76.170	76.152	95.237	95.202	87.33
	76.200	95.250	44.450	2.03	HJ-486028	IR-404828	124	273	42.5	3 700	5 600	0.685	76.200	76.182	95.286	95.250	76.170	76.152	95.237	95.202	87.33
3 1/4	82.550	107.950	44.450	2.03	HJ-526828	IR-445228	162	305	48.3	3 400	5 300	1.016	82.550	82.527	107.986	107.950	82.514	82.492	107.937	107.902	98.43
	82.550	107.950	50.800	2.03	HJ-526832	IR-445232	184	358	56.2	3 400	5 300	1.161	82.550	82.527	107.986	107.950	82.514	82.492	107.937	107.902	98.43
3 1/2	88.900	114.300	50.800	2.03	HJ-567232	IR-475632	187	375	58.9	3 200	4 900	1.238	88.900	88.877	114.336	114.300	88.864	88.842	114.287	114.252	104.78
	88.900	114.300	50.800	2.03	HJ-567232	IR-485632	187	375	58.9	3 200	4 900	1.238	88.900	88.877	114.336	114.300	88.864	88.842	114.287	114.252	104.78

[Notes] 1) See pages B478 to B480 for inch series inner rings. Order inner rings separately.

2) ra max is equal to the minimum bearing chamfer (r min) at unmarked end.

Needle roller thrust bearings, assemblies, washers
thrust needle roller and cage assemblies, thrust washers
metric series
AXK, FNT series

Shaft dia. 6 ~ 45 mm

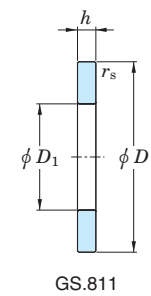
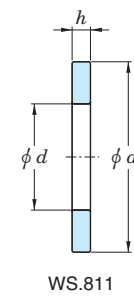
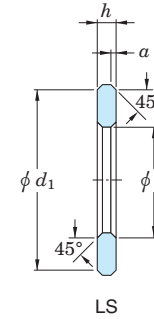
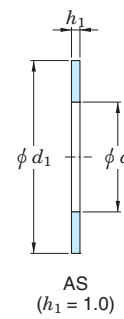
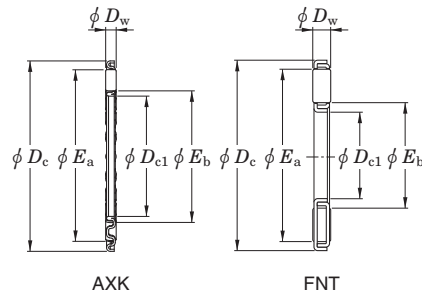
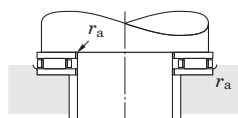
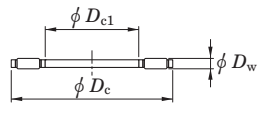

Shaft dia.	Boundary dimensions (mm)						Bearing No.	Basic load ratings (kN)		Fatigue load limit (kN) Cu	Limiting speed (min ⁻¹) Oil lub.	(Refer.) Mass (kg)	Washer dimensions (mm)				Thin Washer No.				Heavy (LS) Washer No.				Heavy Washer No.		(Refer.) Mass (kg)
	Dc1	Dc	Dw	Ea	Eb	ra max.		Ca	Coa				d	D, d1	D1	h1 (mm)	h (h11) (mm)	a (mm)	h (mm)	r min. (mm)	Shaft piloted	Housing piloted					
6	6	19	2	16.9	7.8	0.3	AXK0619TN	6.37	14.3	1.40	23 000	0.001	6	19	1.00	AS0619	0.001										
				18.0	8.0	0.3		FNT-619	6.82									15.6	1.50	21 000	0.002						
8	8	21	2	18.6	9.6	0.3	AXK0821TN	8.34	21.1	2.00	20 000	0.001	8	21	1.00	AS0821	0.002	2.75	0.30	LS0821	0.004						
				20.0	10.0	0.3		FNT-821	7.67									19.1	1.85	20 000	0.002						
10	10	24	2	22.5	11.0	0.3	AXK1024	9.32	25.9	2.90	17 000	0.003	10	24	1.00	AS1024	0.003	2.75	0.50	LS1024	0.008						
				23.0	12.0	0.3		FNT-1024	9.14									25.2	2.40	17 000	0.002						
12	12	26	2	24.5	13.0	0.3	AXK1226	10.8	32.3	3.40	15 000	0.004	12	26	1.00	AS1226	0.003	2.75	0.50	LS1226	0.009						
				25.0	14.0	0.3		FNT-1226	9.92									29.0	2.75	15 000	0.004						
15	15	28	2	27.0	17.0	0.3	AXK1528	11.1	35.2	3.35	15 000	0.004	15	28	1.00	AS1528	0.003	2.75	0.50	LS1528	0.010	2.75	0.30	WS.81102	GS.81102	0.0100	
				27.0	17.0	0.3		FNT-1528	10.2									31.3	3.00	15 000	0.004						
17	17	30	2	28.7	18.3	0.3	AXK1730TN	11.7	38.7	3.70	14 000	0.004	17	30	1.00	AS1730	0.003	2.75	0.50	LS1730	0.011	2.75	0.30	WS.81103	GS.81103	0.011	
				29.0	19.0	0.3		FNT-1730	10.8									34.8	3.35	14 000	0.004						
20	20	35	2	34.0	22.0	0.3	AXK2035	12.8	45.4	4.40	12 000	0.006	20	35	1.00	AS2035	0.005	2.75	0.50	LS2035	0.014	2.75	0.30	WS.81104	GS.81104	0.014	
				34.0	22.0	0.3		FNTA-2035	13.8									50.7	4.80	12 000	0.005						
25	25	42	2	41.0	29.0	0.6	AXK2542	14.3	56.8	5.50	10 000	0.007	25	42	1.00	AS2542	0.007	3.00	1.00	LS2542	0.021	3.00	0.60	WS.81105	GS.81105	0.021	
				41.0	27.0	0.6		FNT-2542	18.0									75.3	8.05	9 700	0.008						
30	30	47	2	46.0	35.0	0.6	AXK3047	16.0	68.1	6.60	9 000	0.009	30	47	1.00	AS3047	0.008	3.00	1.00	LS3047	0.023	3.00	0.60	WS.81106	GS.81106	0.023	
				46.0	32.0	0.6		FNTA-3047	18.6									82.4	8.65	8 900	0.009						
35	35	52	2	51.0	40.0	0.6	AXK3552	17.4	79.5	7.70	8 100	0.010	35	52	1.00	AS3552	0.009	3.50	1.00	LS3552	0.030	3.50	0.60	WS.81107	GS.81107	0.032	
				51.0	37.0	0.6		FNT-3552	21.7									104.0	11.1	7 900	0.010						
40	40	60	3	58.0	45.0	0.6	AXK4060	27.1	110.0	11.9	7 000	0.016	40	60	1.00	AS4060	0.012	3.50	1.00	LS4060	0.041	3.50	0.60	WS.81108	GS.81108	0.043	
				57.0	43.0	0.6		FNT-4060	31.5									132.0	14.6	7 100	0.020						
45	45	65	3	63.0	50.0	0.6	AXK4565	29.0	124.0	13.4	6 500	0.020	45	65	1.00	AS4565	0.013	4.00	1.00	LS4565	0.052	4.00	0.60	WS.81109	GS.81109	0.054	
				63.0	47.0	0.6		FNT-4565	37.6									172.0	18.5	6 400	0.024						

Needle roller thrust bearings, assemblies, washers
thrust needle roller and cage assemblies, thrust washers
metric series
AXK, FNT series

Shaft dia. 50 ~ 160 mm

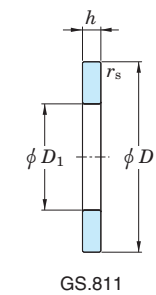
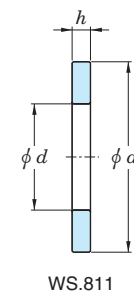
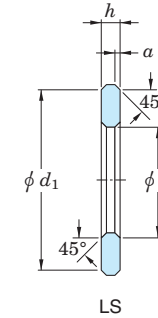
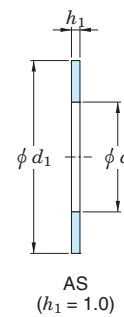
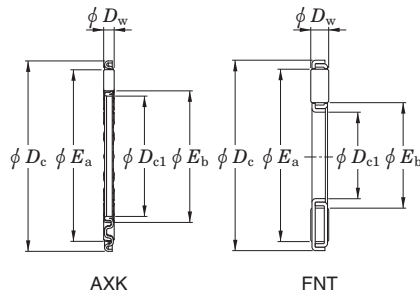
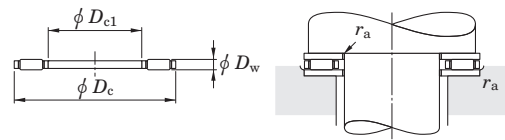

Shaft dia.	Boundary dimensions (mm)						Bearing No.	Basic load ratings (kN)		Fatigue load limit (kN) C_u	Limiting speed (min ⁻¹) Oil lub.	(Refer.) Mass (kg)	Washer dimensions (mm)			Thin Washer		Heavy (LS)		(Refer.) Mass (kg)	r min. (mm)	Heavy Washer No.		(Refer.) Mass (kg)				
	D_{c1}	D_c	D_w	E_a	E_b	$r_{a \text{ max.}}$		C_a	C_{0a}				d	D, d_1, D_1	h_1 (mm)	Washer No.	Mass (kg)	h (h11) (mm)	a (mm)			Washer No.	Mass (kg)		Shaft piloted	Housing piloted		
50	50	70	3	68.0	55.0	0.6	AXK5070	30.8	137.0	14.9	6 000	0.020	50	70	52	1.00	AS5070	0.014	4.00	1.00	LS5070	0.0560	4.00	0.60	WS.81110	GS.81110	0.059	
				68.0	52.0		FNT-5070	37.9	179.0	19.1	5 900	0.026																
55	55	78	3	76.0	60.0	0.6	AXK5578	39.4	195.0	20.5	5 300	0.026	55	78	57	1.00	AS5578	0.018	5.00	1.00	LS5578	0.0910	5.00	0.60	WS.81111	GS.81111	0.094	
				76.0	57.0		FNT-5578	48.5	254.0	26.3	5 300	0.033																
60	60	85	3	83.0	65.0	0.6	AXK6085	44.5	234.0	24.7	4 900	0.035	60	85	62	1.00	AS6085	0.022	4.75	1.50	LS6085	0.102	4.75	1.00	WS.81112	GS.81112	0.106	
65	65	90	3	88.0	70.0	0.6	AXK6590	46.7	254	26.8	4 600	0.036	65	90	67	1.00	AS6590	0.023	5.25	1.50	LS6590	0.121	5.25	1.00	WS.81113	GS.81113	0.125	
70	70	95	4	93.0	74.0	0.6	AXK7095	53.8	253	28.0	4 400	0.055	70	95	72	1.00	AS7095	0.025	5.25	1.50	LS7095	0.1280	5.25	1.00	WS.81114	GS.81114	0.133	
				93.0	73.0		FNTA-7095	66.6	333	35.3	4 400	0.057																
75	75	100	4	98.0	79.0	0.6	AXK75100	55.1	266	29.4	4 200	0.058	75	100	77	1.00	AS75100	0.027	5.75	1.50	LS75100	0.1500	5.75	1.00	WS.81115	GS.81115	0.155	
				98.0	78.0		FNT-75100	71.6	374	39.7	4 100	0.064																
80	80	105	4	103.0	84.0	0.6	AXK80105	56.4	279	30.8	4 000	0.092	80	105	82	1.00	AS80105	0.028	5.75	1.50	LS80105	0.1580	5.75	1.00	WS.81116	GS.81116	0.165	
				103.0	83.0		FNTA-80105	71.3	379	40.1	3 900	0.062																
85	85	110	4	108.0	89.0	0.6	AXK85110	57.6	291	32.2	3 800	0.063	85	110	87	1.00	AS85110	0.028	5.75	1.50	LS85110	0.166	5.75	1.00	WS.81117	GS.81117	0.173	
90	90	120	4	118.0	94.0	0.6	AXK90120	72.9	405	43.0	3 500	0.081	90	120	92	1.00	AS90120	0.038	6.50	1.50	LS90120	0.245	6.50	1.00	WS.81118	GS.81118	0.253	
100	100	135	4	133.0	105.0	0.6	AXK100135	90.2	552	56.4	3 100	0.106	100	135		1.00	AS100135	0.050										
110	110	145	4	143.0	115.0	0.6	AXK110145	93.2	591	59.0	2 800	0.117	110	145		1.00	AS110145	0.055	7.00	1.50	LS110145	0.373	7.00					
120	120	155	4	153.0	125.0	0.6	AXK120155	98.5	650	63.5	2 700	0.126	120	155		1.00	AS120155	0.059										
130	130	170	5	167.0	136.0	0.6	AXK130170	132	829	78.7	2 400	0.198	130	170		1.00	AS130170	0.074	9.00	1.50	LS130170	0.065						
140	140	180	5	177.0	146.0	0.6	AXK140180	136	887	82.5	2 300	0.221	140	180		1.00	AS140180	0.078										
150	150	190	5	187.0	156.0	0.6	AXK150190	141	944	86.2	2 200	0.225	150	190		1.00	AS150190	0.083										
160	160	200	5	197.0	166.0	0.6	AXK160200	146	1 000	89.9	2 100	0.249	160	200		1.00	AS160200	0.089										

Needle roller thrust bearings, assemblies, washers
thrust cylindrical roller and cage assemblies, thrust washers
metric series

Shaft dia. 15 ~ 55 mm

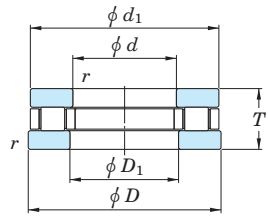

811, 812

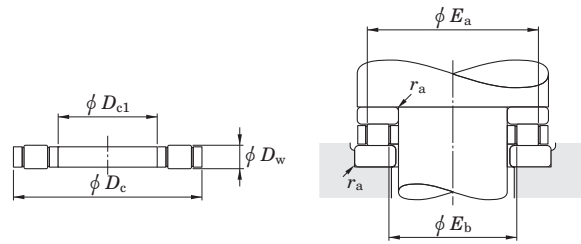

K.811, K.812

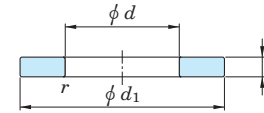

WS.811, WS.812

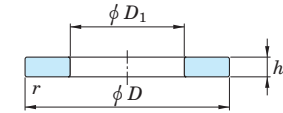

GS.811, GS.812

Shaft dia.	Boundary dimensions (mm)							Bearing No.	Basic load ratings (kN)		Fatigue load limit (kN) C_u	Limiting speed (min ⁻¹) Oil lub.	(Refer.) Mass (kg)	Washer dimensions (mm)						Washer No.		(Refer.) Mass (kg)			
	D_{c1} (E11)	D_c (a13)	D_w	T	E_b max.	E_a min.	r_a max.		C_a	C_{0a}				d	D_1	D, d_1	h max.	h min.	r min.	Shaft piloted	Housing piloted				
15	15	28	3.5	9	18	25	0.3	K.81102LPB K.81102TVP	12.1	26.3	3.70	12 000	0.006	15	16	28	2.75	2.64	0.3	WS.81102 WS.81102	GS.81102 GS.81102	0.010 0.010			
	15	28	3.5	9	18	25	0.3		12.8	28.6				4.05	12 000	0.006	15	16	28				2.75	2.64	0.3
17	17	30	3.5	—	20	27	0.3	K.81103LPB K.81103TVP	12.6	28.6	4.05	11 000	0.008	17	18	30	2.75	2.64	0.3	WS.81103 WS.81103	GS.81103 GS.81103	0.011 0.011			
	17	30	3.5	9	20	27	0.3		14.2	33.4				4.70	11 000	0.008	17	18	30				2.75	2.64	0.3
20	20	35	4.5	10	23	32	0.3	K.81104TVP	23.6	56.8	6.85	9 500	0.009	20	21	35	2.75	2.62	0.3	WS.81104	GS.81104	0.014			
25	25	42	5.0	11	28	39	0.6	K.81105TVP	31.2	81.0	11.4	8 000	0.014	25	26	42	3.00	2.87	0.6	WS.81105	GS.81105	0.021			
30	30	47	5.0	—	33	44	0.6	K.81106LPB K.81106TVP K.81206LPB K.81206TVP	28.5	69.5	10.7	6 700	0.026	30	32	47	3.00	2.87	0.6	WS.81106 WS.81106 WS.81206 WS.81206	GS.81106 GS.81106 GS.81206 GS.81206	0.023 0.023 0.047 0.047			
	30	47	5.0	11	33	44	0.6		33.0	91.1				12.8	6 700	0.016	30	32	47				3.00	2.87	0.6
	30	52	7.5	—	33	49	0.6		53.4	129				13.9	6 300	0.052	30	32	52				4.25	4.12	0.6
	30	52	7.5	16	33	49	0.6		56.9	141				15.2	6 300	0.034	30	32	52				4.25	4.12	0.6
35	35	52	5.0	—	38	49	0.6	K.81107LPB K.81107TVP K.81207LPB K.81207TVP	30.8	86.0	12.1	6 000	0.025	35	37	52	3.50	3.34	0.6	WS.81107 WS.81107 WS.81207 WS.81207	GS.81107 GS.81107 GS.81207 GS.81207	0.032 0.032 0.085 0.085			
	35	52	5.0	12	38	49	0.6		34.8	101				14.2	6 000	0.020	35	37	52				3.50	3.34	0.6
	35	62	7.5	—	41	56	1.0		58.3	152				16.5	5 300	0.073	35	37	62				5.25	5.09	1.0
	35	62	7.5	18	41	56	1.0		61.6	164				17.7	5 300	0.055	35	37	62				5.25	5.09	1.0
40	40	60	6.0	—	44	56	0.6	K.81108LPB K.81108TVP K.81208TVP	44.2	126	12.0	5 300	0.044	40	42	60	3.50	3.34	0.6	WS.81108 WS.81108 WS.81208	GS.81108 GS.81108 GS.81208	0.043 0.043 0.093			
	40	60	6.0	13	44	56	0.6		49.8	148				14.1	5 300	0.031	40	42	60				3.50	3.34	0.6
	40	68	9.0	19	45	63	1.0		86.8	233				26.9	4 800	0.076	40	42	68				5.00	4.84	1.0
45	45	65	6.0	—	49	61	0.6	K.81109LPB K.81109TVP K.81209TVP	47.0	140	13.4	4 800	0.035	45	47	65	4.00	3.84	0.6	WS.81109 WS.81109 WS.81209	GS.81109 GS.81109 GS.81209	0.054 0.054 0.112			
	45	65	6.0	14	49	61	0.6		52.3	163				15.5	4 800	0.035	45	47	65				4.00	3.84	0.6
	45	73	9.0	—	50	68	1.0		94.2	266				30.8	4 500	0.083	45	47	73				5.50	5.34	1.0
50	50	70	6.0	14	54	66	0.6	K.81110LPB K.81110TVP K.81210TVP	49.7	155	14.8	4 300	0.052	50	52	70	4.00	3.84	0.6	WS.81110 WS.81110 WS.81210	GS.81110 GS.81110 GS.81210	0.059 0.059 0.144			
	50	70	6.0	14	54	66	0.6		54.8	177				17.0	4 300	0.042	50	52	70				4.00	3.84	0.6
	50	78	9.0	22	55	73	1.0		101	299				34.6	4 000	0.089	50	52	78				6.5	6.34	1.0
55	55	78	6.0	16	60	73	0.6	K.81111TVP K.81211LPB K.81211TVP	60.3	207	19.8	4 000	0.066	55	57	78	5.00	4.81	0.6	WS.81111 WS.81211 WS.81211	GS.81111 GS.81211 GS.81211	0.094 0.219 0.219			
	55	90	11.0	—	61	84	1.0		127	359				39.6	3 600	0.156	55	57	90				7.00	6.81	1.0
	55	90	11.0	25	61	84	1.0		138	403				45.2	3 600	0.140	55	57	90				7.00	6.81	1.0

Needle roller thrust bearings, assemblies, washers
thrust cylindrical roller and cage assemblies, thrust washers
metric series

Shaft dia. 60 ~ 90 mm

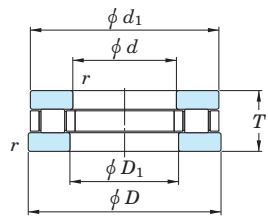

811, 812

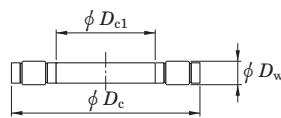

K.811, K.812

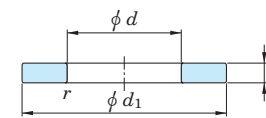
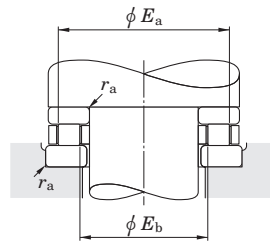

WS.811, WS.812

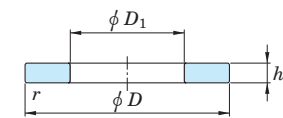

GS.811, GS.812

Shaft dia.	Boundary dimensions (mm)							Bearing No.	Basic load ratings (kN)		Fatigue load limit (kN) C_u	Limiting speed (min ⁻¹) Oil lub.	(Refer.) Mass (kg)	Washer dimensions (mm)						Washer No.		(Refer.) Mass (kg)
	D_{c1} (E11)	D_c (a13)	D_w	T	E_b max.	E_a min.	r_a max.		C_a	C_{0a}				d	D_1	D, d_1	h max.	h min.	r min.	Shaft piloted	Housing piloted	
60	60	85	7.5	17	65	80	1.0	K.81112TVP K.81212LPB	84.4	281	30.4	3 600	0.103	60	62	85	4.75	4.56	1.0	WS.81112 WS.81212	GS.81112 GS.81212	0.106 0.251
	60	95	11.0	26	66	89	1.0		129	378				42.4	3 400	0.166	60	62	95			
65	65	90	7.5	18	70	85	1.0	K.81113TVP K.81213LPB	88.3	305	33.0	3 400	0.109	65	67	90	5.25	5.06	1.0	WS.81113 WS.81213	GS.81113 GS.81213	0.125 0.285
	65	100	11.0	27	71	94	1.0		134	403				45.2	3 200	0.176	65	67	100			
70	70	95	7.5	18	75	90	1.0	K.81114TVP K.81214LPB	92.1	328	35.5	3 200	0.056	70	72	95	5.25	5.06	1.0	WS.81114 WS.81214	GS.81114 GS.81214	0.133 0.302
	70	105	11.0	27	76	99	1.0		138	428				48.0	3 000	0.186	70	72	105			
75	75	100	7.5	19	80	95	1.0	K.81115LPB K.81215LPB	86.1	305	33.0	3 000	0.091	75	77	100	5.75	5.56	1.0	WS.81115 WS.81215	GS.81115 GS.81215	0.155 0.319
	75	110	11.0	27	81	104	1.0		143	453				50.9	2 800	0.197	75	77	110			
80	80	105	7.5	19	85	100	1.0	K.81116LPB K.81216LPB	87.5	316	34.2	2 800	0.103	80	82	105	5.75	5.56	1.0	WS.81116 WS.81216	GS.81116 GS.81216	0.165 0.357
	80	115	11.0	28	86	109	1.0		147	478				53.7	2 600	0.208	80	82	115			
85	85	110	7.5	19	90	105	1.0	K.81117LPB K.81217LPB	88.9	328	35.5	2 600	0.108	85	87	110	5.75	5.53	1.0	WS.81117 WS.81217	GS.81117 GS.81217	0.173 0.492
	85	125	12.0	31	93	117	1.0		174	572				65.5	2 400	0.376	85	88	125			
90	90	120	9.0	22	96	114	1.0	K.81118LPB K.81218LPB	119	432	49.3	2 400	0.156	90	92	120	6.50	6.28	1.0	WS.81118 WS.81218	GS.81118 GS.81218	0.253 0.655
	90	135	14.0	35	98	127	1.0		215	691				81.5	2 400	0.540	90	93	135			

Needle roller thrust bearings, assemblies, washers
thrust needle roller and cage assemblies, thrust washers
inch series

Shaft dia. $1/4 \sim (7/8)$ in (6.35 ~ (22.23) mm)

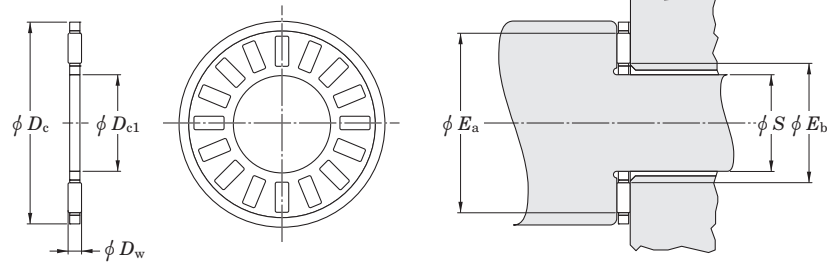

NTA

Raceway hardness to be 58 HRC or equivalent

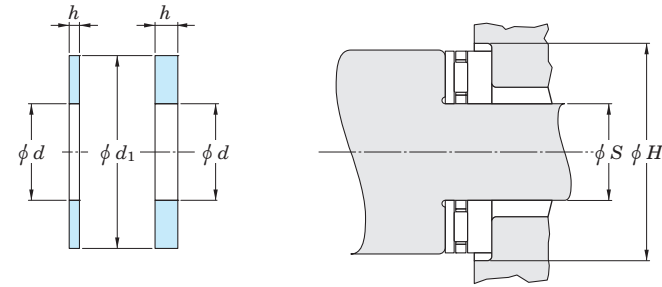

Shaft dia. (in)	Boundary dimensions (mm)					Bearing No.	Basic load ratings (kN)		Fatigue load limit (kN) Cu	Limiting speed ¹⁾ (min ⁻¹)	(Refer.) Mass (kg)	Washer No.	Washer dimensions (mm)				Piloting dimensions (mm) S		Dia. to clear O.D. (mm) H ²⁾	(Refer.) Washer mass (kg)
	Dc1	Dc	Dw	Eb	Ea		Ca	C0a					d	d1	max.	min.	max.	min.		
1/4	6.35	17.45	1.984	8.636	14.732	NTA-411	5.12	10.76	1.05	26 000	0.001	TRA-411	6.35	17.45	0.81	0.76	6.35	6.27	18.26	0.001
												TRB-411	6.35	17.45	1.60	1.52	6.35	6.27	18.26	0.002
												TRC-411	6.35	17.45	2.41	2.34	6.35	6.27	18.26	0.004
5/16	7.92	19.05	1.984	10.16	16.256	NTA-512	5.83	13.17	1.30	24 000	0.002	TRA-512	7.92	19.05	0.81	0.76	7.92	7.85	19.84	0.001
												TRB-512	7.92	19.05	1.60	1.52	7.92	7.85	19.84	0.003
3/8	9.53	20.625	1.984	11.68	18.034	NTA-613	6.05	14.32	1.40	22 000	0.002	TRA-613	9.53	20.62	0.81	0.76	9.53	9.45	21.44	0.001
												TRB-613	9.53	20.62	1.60	1.52	9.53	9.45	21.44	0.003
												TRC-613	9.53	20.62	2.41	2.34	9.53	9.45	21.44	0.004
1/2	12.70	23.80	1.984	14.99	21.08	NTA-815	7.16	19.13	1.85	19 000	0.002	TRA-815	12.70	23.80	0.81	0.76	12.70	12.62	24.61	0.002
												TRB-815	12.70	23.80	1.60	1.52	12.70	12.62	24.61	0.004
												TRC-815	12.70	23.80	2.41	2.34	12.70	12.62	24.61	0.005
9/16	14.275	25.40	1.9837	16.51	22.606	NTA-916	7.70	21.53	2.10	18 000	0.003	TRA-916	14.27	25.40	0.81	0.76	14.27	14.20	26.19	0.002
												TRB-916	14.27	25.40	1.60	1.52	14.27	14.20	26.19	0.004
												TRC-916	14.27	25.40	2.41	2.34	14.27	14.20	26.19	0.006
5/8	15.88	28.575	1.9837	18.03	25.908	NTA-1018	9.79	30.38	2.85	15 000	0.003	TRA-1018	15.88	28.58	0.81	0.76	15.88	15.80	29.36	0.003
												TRB-1018	15.88	28.58	1.60	1.52	15.88	15.80	29.36	0.005
												TRC-1018	15.88	28.58	2.41	2.34	15.88	15.80	29.36	0.008
												TRD-1018	15.88	28.58	3.20	3.12	15.88	15.80	29.36	0.011
												TRE-1018	15.88	28.58	3.99	3.91	15.88	15.80	29.36	0.013
3/4	19.05	31.75	1.9837	21.34	28.956	NTA-1220	10.90	36.48	3.40	14 000	0.004	TRA-1220	19.05	31.75	0.81	0.76	19.05	18.97	32.54	0.003
												TRB-1220	19.05	31.75	1.60	1.52	19.05	18.97	32.54	0.006
												TRC-1220	19.05	31.75	2.41	2.34	19.05	18.97	32.54	0.010
												TRD-1220	19.05	31.75	3.20	3.12	19.05	18.97	32.54	0.012
												TRE-1220	19.05	31.75	3.99	3.91	19.05	18.97	32.54	0.015
7/8	22.23	36.50	1.984	24.38	33.782	NTA-1423	13.43	49.82	4.65	12 000	0.005	TRA-1423	22.23	36.50	0.81	0.76	22.23	22.15	37.31	0.004
												TRB-1423	22.23	36.50	1.60	1.52	22.23	22.15	37.31	0.008

[Notes] 1) Limiting speeds listed are based on adequate oil lubrication.
 Suggestions for an application requiring O.D. piloting should be determined in consultation with JTEKT.

2) If the shaft and the housing adjacent to the bearing O.D. are not concentric, the T.I.R. between the shaft and housing should be added to this dimension.

Needle roller thrust bearings, assemblies, washers
thrust needle roller and cage assemblies, thrust washers
inch series

Shaft dia. (7/8) ~ (1 1/2) in ((22.23) ~ (38.10) mm)

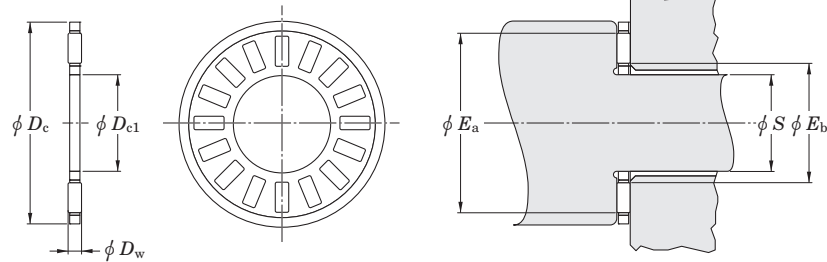

NTA

Raceway hardness to be 58 HRC or equivalent

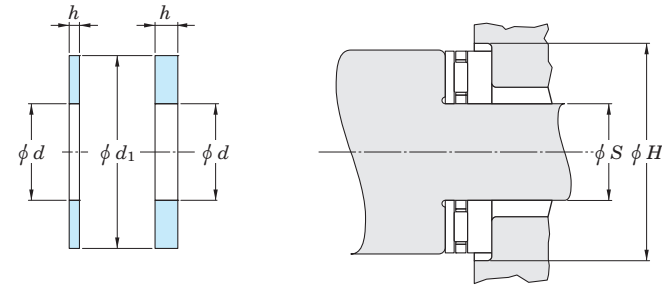

Shaft dia. (in)	Boundary dimensions (mm)					Bearing No.	Basic load ratings (kN)		Fatigue load limit (kN) Cu	Limiting speed ¹⁾ (min ⁻¹)	(Refer.) Mass (kg)	Washer No.	Washer dimensions (mm)				Piloting dimensions (mm) S		Dia. to clear O.D. (mm) H ²⁾	(Refer.) Washer mass (kg)
	Dc1	Dc	Dw	Eb	Ea		Ca	C0a					d	d1	max.	min.	max.	min.		
7/8	22.23	42.85	1.984	25.91	39.878	NTC-1427	18.46	78.29	8.05	9 800	0.008	TRC-1423	22.23	36.50	2.41	2.34	22.23	22.15	37.31	0.012
												TRD-1423	22.23	36.50	3.20	3.12	22.23	22.15	37.31	0.015
												TRB-1427	22.23	42.86	1.60	1.52	22.23	22.15	43.66	0.013
												TRC-1427	22.23	42.86	2.41	2.34	22.23	22.15	43.66	0.020
												TRD-1427	22.23	42.86	3.20	3.12	22.23	22.15	43.66	0.026
1	25.40	39.675	1.984	27.69	36.83	NTA-1625	13.83	53.82	5.00	11 000	0.006	TRA-1625	25.40	39.67	0.81	0.76	25.40	25.32	40.49	0.005
												TRB-1625	25.40	39.67	1.60	1.52	25.40	25.32	40.49	0.009
												TRD-1625	25.40	39.67	3.20	3.12	25.40	25.32	40.49	0.017
												TRE-1625	25.40	39.67	3.99	3.91	25.40	25.32	40.49	0.021
1 1/8	28.58	44.45	1.9837	30.73	41.656	NTA-1828	16.68	71.17	7.30	9 600	0.009	TRA-1828	28.58	44.45	0.81	0.76	28.58	28.50	45.24	0.006
												TRB-1828	28.58	44.45	1.60	1.52	28.58	28.50	45.24	0.011
												TRC-1828	28.58	44.45	2.41	2.34	28.58	28.50	45.24	0.017
												TRD-1828	28.58	44.45	3.20	3.12	28.58	28.50	45.24	0.022
1 1/4	31.75	49.20	1.9837	34.04	46.228	NTA-2031	20.15	93.41	9.55	8 600	0.010	TRA-2031	31.75	49.20	0.81	0.76	31.75	31.67	50.01	0.007
												TRB-2031	31.75	49.20	1.60	1.52	31.75	31.67	50.01	0.014
												TRC-2031	31.75	49.20	2.41	2.34	31.75	31.67	50.01	0.020
												TRD-2031	31.75	49.20	3.20	3.12	31.75	31.67	50.01	0.026
												TRF-2031	31.75	49.20	4.78	4.70	31.75	31.67	50.01	0.041
1 3/8	34.93	52.375	1.9837	37.08	49.53	NTA-2233	21.35	103.20	10.5	8 000	0.010	TRA-2233	34.93	52.37	0.81	0.76	34.93	34.85	53.19	0.007
												TRB-2233	34.93	52.37	1.60	1.52	34.93	34.85	53.19	0.015
												TRC-2233	34.93	52.37	2.41	2.34	34.93	34.85	53.19	0.018
												TRD-2233	34.93	52.37	3.20	3.12	34.93	34.85	53.19	0.029
												TRE-2233	34.93	52.37	3.99	3.91	34.93	34.85	53.19	0.037
												TRF-2233	34.93	52.37	4.78	4.70	34.93	34.85	53.19	0.044
1 1/2	38.10	55.55	1.9837	40.39	52.578	NTA-2435	23.22	117.88	12.0	7 600	0.011	TRA-2435	38.10	55.55	0.81	0.76	38.10	38.02	56.36	0.008
												TRB-2435	38.10	55.55	1.60	1.52	38.10	38.02	56.36	0.015

[Notes] 1) Limiting speeds listed are based on adequate oil lubrication. Suggestions for an application requiring O.D. piloting should be determined in consultation with JTEKT.

2) If the shaft and the housing adjacent to the bearing O.D. are not concentric, the T.I.R. between the shaft and housing should be added to this dimension.

Needle roller thrust bearings, assemblies, washers
thrust needle roller and cage assemblies, thrust washers
inch series

Shaft dia. (1 1/2) ~ (2 1/2) in ((38.10) ~ (63.50) mm)

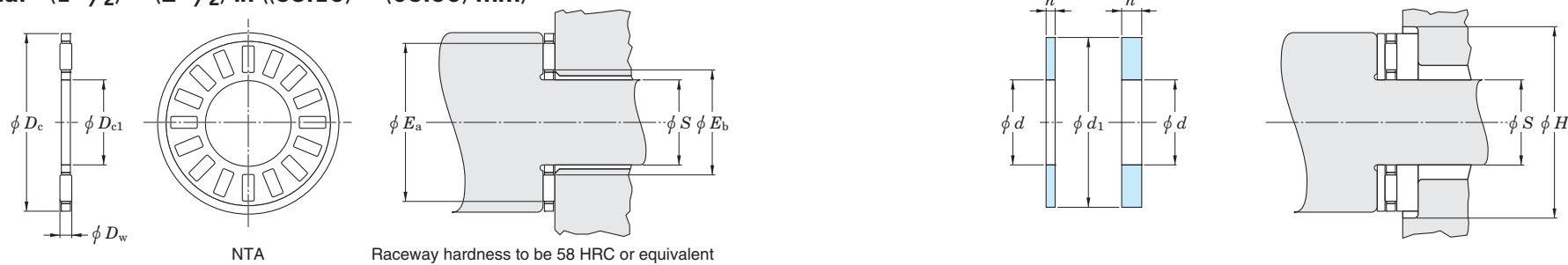

NTA

Raceway hardness to be 58 HRC or equivalent

Shaft dia. (in)	Boundary dimensions (mm)					Bearing No.	Basic load ratings (kN)		Fatigue load limit (kN) Cu	Limiting speed ¹⁾ (min ⁻¹)	(Refer.) Mass (kg)	Washer No.	Washer dimensions (mm)				Piloting dimensions (mm) S		Dia. to clear O.D. (mm) H ²⁾	(Refer.) Washer mass (kg)
	Dc1	Dc	Dw	Eb	Ea		Ca	C0a					d	d1	max.	min.	max.	min.		
1 1/2	38.10	55.55	1.9837	40.39	52.578	NTA-2435	23.22	117.88	12.0	7 600	0.011	TRC-2435	38.10	55.55	2.41	2.34	38.10	38.02	56.36	0.023
												TRD-2435	38.10	55.55	3.20	3.12	38.10	38.02	56.36	0.030
												TRF-2435	38.10	55.55	4.78	4.70	38.10	38.02	56.36	0.045
1 3/4	44.45	63.50	1.984	46.74	58.928	NTA-2840	25.31	137.45	14.0	6 800	0.014	TRA-2840	44.45	63.50	0.81	0.76	44.45	44.37	64.29	0.010
												TRB-2840	44.45	63.50	1.60	1.52	44.45	44.37	64.29	0.020
												TRC-2840	44.45	63.50	2.41	2.34	44.45	44.37	64.29	0.029
												TRD-2840	44.45	63.50	3.20	3.12	44.45	44.37	64.29	0.038
												TRF-2840	44.45	63.50	4.78	4.70	44.45	44.37	64.29	0.057
2	50.80	69.85	1.9837	53.09	65.278	NTA-3244	24.02	132.56	13.5	6 100	0.015	TRA-3244	50.80	69.85	0.81	0.76	50.80	50.72	70.64	0.011
												TRB-3244	50.80	69.85	1.60	1.52	50.80	50.72	70.64	0.022
												TRC-3244	50.80	69.85	2.41	2.34	50.80	50.72	70.64	0.033
												TRD-3244	50.80	69.85	3.20	3.12	50.80	50.72	70.64	0.044
												TRF-3244	50.80	69.85	4.78	4.70	50.80	50.72	70.64	0.066
2 1/8	53.98	73.025	1.984	56.39	68.58	NTA-3446	24.42	137.45	14.0	5 800	0.016	TRA-3446	53.98	73.03	0.81	0.76	53.98	53.90	73.81	0.012
												TRB-3446	53.98	73.03	1.60	1.52	53.98	53.90	73.81	0.024
												TRC-3446	53.98	73.03	2.41	2.34	53.98	53.90	73.81	0.035
												TRD-3446	53.98	73.03	3.20	3.12	53.98	53.90	73.81	0.047
2 1/4	57.15	76.20	1.984	59.44	71.628	NTA-3648	24.78	142.34	14.6	5 600	0.017	TRA-3648	57.15	76.20	0.81	0.76	57.15	57.07	76.99	0.012
												TRB-3648	57.15	76.20	1.60	1.52	57.15	57.07	76.99	0.022
												TRC-3648	57.15	76.20	2.41	2.34	57.15	57.07	76.99	0.037
												TRD-3648	57.15	76.20	3.20	3.12	57.15	57.07	76.99	0.048
												TRF-3648	57.15	76.20	4.78	4.70	57.15	57.07	76.99	0.071
2 1/2	57.15	79.375	3.175	59.94	75.184	NTA-3650	37.68	177.04	18.6	5 300	0.029	TRA-3650	57.15	76.20	0.81	0.76	57.15	57.07	76.99	0.012
												TRB-3650	57.15	76.20	1.60	1.52	57.15	57.07	76.99	0.022
2 1/2	63.50	82.55	1.9837	65.79	77.978	NTA-4052	25.53	152.13	15.6	5 100	0.019	TRA-4052	63.50	82.55	0.81	0.76	63.50	63.42	83.34	0.013
												TRB-4052	63.50	82.55	1.60	1.52	63.50	63.42	83.34	0.027
												TRC-4052	63.50	82.55	2.41	2.34	63.50	63.42	83.34	0.041

[Notes] 1) Limiting speeds listed are based on adequate oil lubrication.
 Suggestions for an application requiring O.D. piloting should be determined in consultation with JTEKT.

2) If the shaft and the housing adjacent to the bearing O.D. are not concentric, the T.I.R. between the shaft and housing should be added to this dimension.

Needle roller thrust bearings, assemblies, washers
thrust needle roller and cage assemblies, thrust washers
inch series

Shaft dia. (2 1/2) ~ 4 1/8 in ((63.50) ~ 104.78 mm)

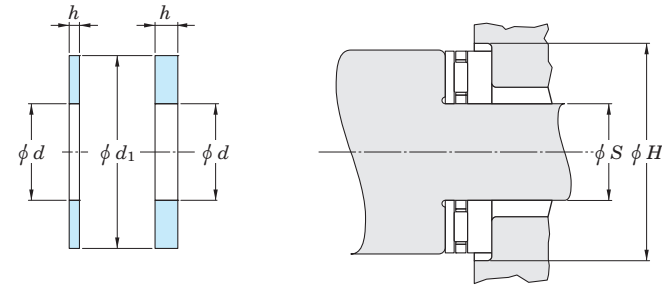
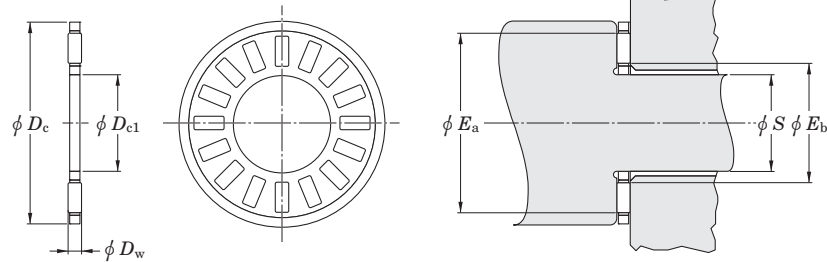

Shaft dia. (in)	Boundary dimensions (mm)					Bearing No.	Basic load ratings (kN)		Fatigue load limit (kN) Cu	Limiting speed ¹⁾ (min ⁻¹)	(Refer.) Mass (kg)	Washer No.	Washer dimensions (mm)				Piloting dimensions (mm) S		Dia. to clear O.D. (mm) H ²⁾	(Refer.) Washer mass (kg)
	Dc1	Dc	Dw	Eb	Ea		Ca	C0a					d	d1	max.	min.	max.	min.		
2 1/2	63.50	82.55	1.9837	65.79	77.978	NTA-4052	25.53	152.13	15.6	5 100	0.019	TRC-4052	63.50	82.55	3.20	3.12	63.50	63.42	83.34	0.054
2 3/4	69.85	92.075	3.175	72.64	87.884	NTA-4458	47.60	255.8	26.8	4 600	0.037	TRA-4458	69.85	92.08	0.81	0.76	69.85	69.77	92.86	0.018
												TRB-4458	69.85	92.08	1.60	1.52	69.85	69.77	92.86	0.035
												TRC-4458	69.85	92.08	2.41	2.34	69.85	69.77	92.86	0.051
												TRD-4458	69.85	92.08	3.20	3.12	69.85	69.77	92.86	0.069
TRF-4458	69.85	92.08	4.78	4.70	69.85	69.77	92.86	0.104												
3	76.20	95.25	1.9837	78.49	90.678	NTA-4860	26.96	172.1	17.6	4 400	0.022	TRA-4860	76.20	95.25	0.81	0.76	76.20	76.12	96.04	0.015
3 1/4	82.55	104.78	3.175	85.34	100.58	NTA-5266	51.60	294.9	30.9	4 000	0.042	TRA-5266	82.55	104.78	0.81	0.76	82.55	82.47	105.56	0.020
												TRB-5266	82.55	104.78	1.60	1.52	82.55	82.47	105.56	0.032
												TRD-5266	82.55	104.78	3.20	3.12	82.55	82.47	105.56	0.061
3 3/4	95.25	117.48	3.175	98.04	113.28	NTA-6074	56.05	344.3	35.5	3 500	0.050	TRA-6074	95.25	117.48	0.81	0.76	95.25	95.17	118.26	0.023
												TRB-6074	95.25	117.48	1.60	1.52	95.25	95.17	118.26	0.046
												TRC-6074	95.25	117.48	2.41	2.34	95.25	95.17	118.26	0.069
												TRD-6074	95.25	117.48	3.20	3.12	95.25	95.17	118.26	0.092
4 1/8	104.78	128.57	3.175	107.44	124.46	NTA-6681	63.61	414.6	41.3	3 200	0.062	TRA-6681	104.78	128.57	0.81	0.76	104.78	104.70	129.39	0.027
												TRC-6681	104.78	128.57	2.41	2.34	104.78	104.70	129.39	0.081
												TRD-6681	104.78	128.57	3.20	3.12	104.78	104.70	129.39	0.109
												TRF-6681	104.78	128.57	4.78	4.70	104.78	104.70	129.39	0.161

[Notes] 1) Limiting speeds listed are based on adequate oil lubrication.
 Suggestions for an application requiring O.D. piloting should be determined in consultation with JTEKT.

2) If the shaft and the housing adjacent to the bearing O.D. are not concentric, the T.I.R. between the shaft and housing should be added to this dimension.

**Combined needle roller bearings
ball thrust series
metric series**

Shaft dia. 10 ~ 70 mm

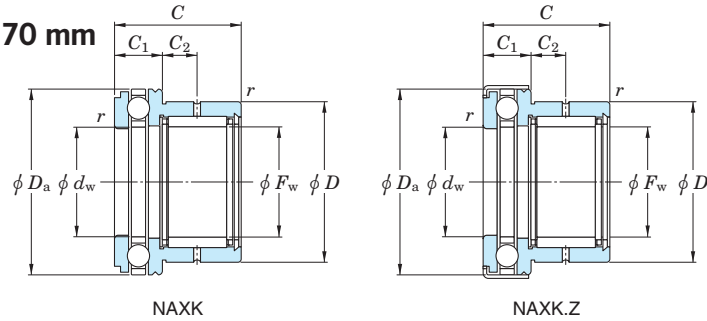

Shaft dia.	Boundary dimensions (mm)								Bearing No.	Limiting speed (min ⁻¹) Oil lub.	Basic load ratings (kN)				Fatigue load limits (kN)		(Refer.) Mass (kg)	Matching inner ring No.
	F _w	D	C	d _w (E7)	D _a	C ₁	C ₂	r _{min.}			Radial C _r	Thrust C _{0r}	Radial C _u	Thrust C _{0a}				
10	10	19	23	10	24	9	6.5	0.3	NAXK10 NAXK10Z	9 500	7.9	8.7	10.4	14	1.35	0.630	0.04	JR7x10x16
	10	19	23	10	25	9	6.5	0.3		9 500	7.9	8.7	10.4	14	1.35	0.630	0.04	JR7x10x16
12	12	21	23	12	26	9	6.5	0.3	NAXK12 NAXK12Z	9 000	7.5	8.5	10.7	15.4	1.30	0.690	0.046	JR9x12x16
	12	21	23	12	27	9	6.5	0.3		9 000	7.5	8.5	10.7	15.4	1.30	0.690	0.047	JR9x12x16
15	15	24	23	15	28	9	6.5	0.3	NAXK15 NAXK15Z	8 500	9.7	12.6	10.9	16.8	1.90	0.760	0.047	JR12x15x16
	15	24	23	15	29	9	6.5	0.3		8 500	9.7	12.6	10.9	16.8	1.90	0.760	0.05	JR12x15x16
17	17	26	25	17	30	9	8	0.3	NAXK17 NAXK17Z	8 500	11.4	16.1	11.8	19.6	2.50	0.880	0.06	JR14x17x17
	17	26	25	17	31	9	8	0.3		8 500	11.4	16.1	11.8	19.6	2.50	0.880	0.064	JR14x17x17
20	20	30	30	20	35	10	10.5	0.3	NAXK20 NAXK20Z	7 000	14.8	23.7	15.5	26.6	3.65	1.20	0.089	JR17x20x20
	20	30	30	20	36	10	10.5	0.3		7 000	14.8	23.7	15.5	26.6	3.65	1.20	0.094	JR17x20x20
25	25	37	30	25	42	11	9.5	0.6	NAXK25 NAXK25Z	6 300	18.8	29.8	18.8	35.5	4.60	1.60	0.134	JR20x25x20
	25	37	30	25	43	11	9.5	0.6		6 300	18.8	29.8	18.8	35.5	4.60	1.60	0.141	JR20x25x20
30	30	42	30	30	47	11	9.5	0.6	NAXK30 NAXK30Z	5 600	20.2	34.6	19.5	39.9	5.35	2.15	0.146	JR25x30x20
	30	42	30	30	48	11	9.5	0.6		5 600	20.2	34.6	19.5	39.9	5.35	2.15	0.154	JR25x30x20
35	35	47	30	35	52	12	9	0.6	NAXK35 NAXK35Z	5 300	22.1	40.8	20.8	46.6	6.35	2.10	0.176	JR30x35x20
	35	47	30	35	53	12	9	0.6		5 300	22.1	40.8	20.8	46.6	6.35	2.10	0.184	JR30x35x20
40	40	52	32	40	60	13	10	0.6	NAXK40 NAXK40Z	4 500	23.8	47	28	62.9	7.30	2.85	0.224	JR35x40x20
	40	52	32	40	61	13	10	0.6		4 500	23.8	47	28	62.9	7.30	2.85	0.233	JR35x40x20
45	45	58	32	45	65	14	9	0.6	NAXK45 NAXK45Z	4 500	24.9	51.8	29	69.2	8.05	3.10	0.262	JR40x45x20
	45	58	32	45	66.5	14	9	0.6		4 500	24.9	51.8	29	69.2	8.05	3.10	0.275	JR40x45x20
50	50	62	35	50	70	14	10	0.6	NAXK50 NAXK50Z	4 300	30.2	68.5	29.9	75.5	10.7	3.40	0.316	JR45x50x25
	50	62	35	50	71.5	14	10	0.6		4 300	30.2	68.5	29.9	75.5	10.7	3.40	0.332	JR45x50x25
60	60	72	40	60	85	17	12	1	NAXK60	3 600	31.9	78.1	43	113	12.2	5.10	0.48	JR50x60x25
70	70	85	40	70	95	18	11	1	NAXK70	3 400	43.6	87.9	41.6	110	13.9	4.95	0.659	JR60x70x25

**Combined needle roller bearings
cylindrical roller thrust series
metric series**

Shaft dia. 10 ~ 45 mm

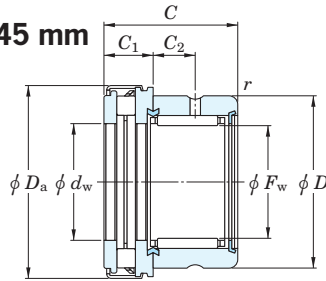

RAXZ 500

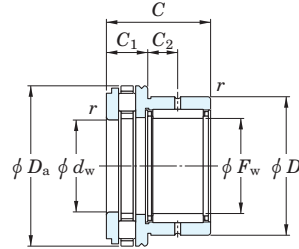

NAXR

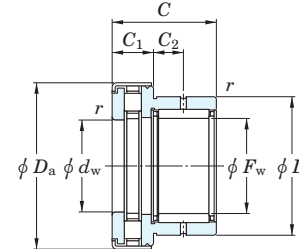

NAXR.Z

Shaft dia.	Boundary dimensions (mm)								Bearing No.			Limiting speed (min ⁻¹)	Basic load ratings (kN)				Fatigue load limits (kN)		(Refer.) Mass (kg)	Matching inner ring No.
	F _w	D	C	d _w (E7)	D _a	C ₁	C ₂	r _{min.}	RAXZ	NAXR	NAXR.Z		Radial C _r	Thrust C _{0r}	Radial C _u	Thrust C _{0a}	Radial	Thrust		
10	10	19	21.5	10	22.4	7.5	6	0.35	RAXZ 510	—	—	15 500	5.9	7.2	8.2	17.9	1.15	1.85	0.026	IM 7 10 16 P
12	12	21	22	12	26.4	8	6	0.35	RAXZ 512	—	—	13 000	6.8	9.0	12.7	29.5	1.30	3.10	0.033	IM 9 12 16 P
15	15	24	23	15	28	9	6.5	0.3	—	NAXR15	—	12 000	9.7	12.6	12.1	26.3	2.30	3.70	0.032	JR12x15x16
	15	24	23	15	29	9	6.5	0.3	—	—	NAXR15.Z	12 000	9.7	12.6	12.1	26.3	2.30	3.70	0.035	JR12x15x16
	15	24	22	15	28.4	8	6	0.35	RAXZ 515	—	—	11 500	9.7	12.6	14.0	34.0	1.80	3.65	0.036	IM 12 15 16 P
17	17	26	25	17	30	9	8.0	0.3	—	NAXR17	—	11 000	11.4	16.1	12.6	28.6	2.70	4.05	0.050	JR14x17x17
	17	26	25	17	31	9	8.0	0.3	—	—	NAXR17.Z	11 000	11.4	16.1	12.6	28.6	2.70	4.05	0.053	JR14x17x17
	17	26	24	17	30.4	8	8	0.65	RAXZ 517	—	—	10 500	11.8	16.3	15.0	39.0	2.50	4.15	0.044	IM 14 17 17 P
20	20	30	30	20	35	10	10.5	0.3	—	NAXR20TN	—	9 500	14.8	23.7	23.6	56.8	4.00	8.00	0.090	JR17x20x20
	20	30	30	20	36	10	10.5	0.3	—	—	NAXR20Z.TN	9 500	14.8	23.7	23.6	56.8	4.00	8.00	0.095	JR17x20x20
	20	30	29	20	35.4	11	9	0.85	RAXZ 520	—	—	9 000	14.8	23.7	22.0	54.0	3.55	5.55	0.070	IM 15 20 20 P
25	25	37	30	25	42	11	9.5	0.6	—	NAXR25TN	—	8 000	18.8	29.8	31.2	81.0	4.80	11.4	0.146	JR20x25x20
	25	37	30	25	43	11	9.5	0.6	—	—	NAXR25Z.TN	8 000	18.8	29.8	31.2	81.0	4.80	11.4	0.152	JR20x25x20
	25	37	29	25	43	11	9	0.85	RAXZ 525	—	—	7 500	15.1	26.2	25.5	70.0	4.25	7.15	0.105	IM 20 25 20 P
30	30	42	30	30	47	11	9.5	0.6	—	NAXR30TN	—	6 700	20.2	34.6	33.0	91.1	6.10	12.8	0.162	JR25x30x20
	30	42	30	30	48	11	9.5	0.6	—	—	NAXR30Z.TN	6 700	20.2	34.6	33.0	91.1	6.10	12.8	0.169	JR25x30x20
	30	42	29	30	48	11	9	0.85	RAXZ 530	—	—	6 500	20.2	34.6	26.5	77.0	5.25	7.90	0.118	IM 25 30 20 P
35	35	47	30	35	52	12	9.0	0.6	—	NAXR35	—	6 000	22.1	40.8	30.9	86.0	7.05	12.1	0.186	JR30x35x20
	35	47	30	35	53	12	9.0	0.6	—	—	NAXR35.Z	6 000	22.1	40.8	30.9	86.0	7.05	12.1	0.195	JR30x35x20
	35	47	30	35	54	12	9	0.85	RAXZ 535	—	—	5 500	22.1	40.8	33.8	94.0	6.15	8.80	0.146	IM 30 35 20 P
40	40	52	32	40	60	13	10.0	0.6	—	NAXR40	—	5 300	23.8	47.0	44.5	126.0	8.05	12.0	0.288	JR35x40x20
	40	52	32	40	61	13	10.0	0.6	—	—	NAXR40.Z	5 300	23.8	47.0	44.5	126.0	8.05	12.0	0.299	JR35x40x20
	40	52	31	40	61	13	9	0.85	RAXZ 540	—	—	5 000	23.8	47.0	46.0	129.0	7.00	5.95	0.174	IM 35 40 20 P
45	45	58	32	45	65	14	9.0	0.6	—	NAXR45TN	—	4 800	24.9	51.8	47.0	140.0	9.00	15.5	0.360	JR40x45x20
	45	58	32	45	66	14	9.0	0.6	—	—	NAXR45Z.TN	4 800	24.9	51.8	47.0	140.0	9.00	15.5	0.370	JR40x45x20
	45	58	31	45	66	13	9	0.85	RAXZ 545	—	—	4 500	24.9	51.8	49.0	143.0	7.90	6.60	0.206	IM 40 45 20 P

**Combined needle roller bearings
cylindrical roller thrust series
metric series**

Shaft dia. 50 ~ 70 mm

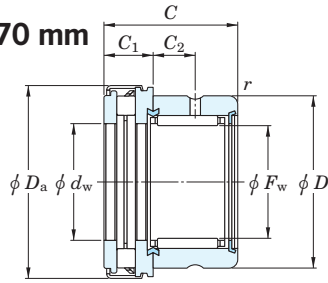

RAXZ 500

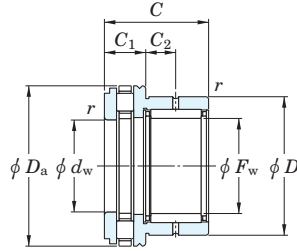

NAXR

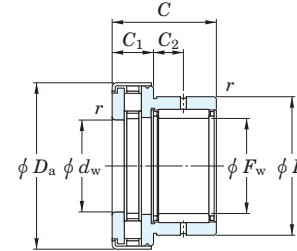

NAXR.Z

Shaft dia.	Boundary dimensions (mm)								Bearing No.			Limiting speed (min ⁻¹)	Basic load ratings (kN)				Fatigue load limits (kN)		(Refer.) Mass (kg)	Matching inner ring No.
	F _w	D	C	d _w (E7)	D _a	C ₁	C ₂	r _{min.}	RAXZ	NAXR	NAXR.Z		Radial		Thrust		Radial	Thrust		
													C _r	C _{0r}	C _a	C _{0a}				
50	50	62	35	50	70	14	10.0	0.6	—	NAXR50	—	4 300	30.2	68.5	49.7	155.0	12.5	14.8	0.432	JR45x50x25
	50	62	35	50	71	14	10.0	0.6	—	—	NAXR50.Z	4 300	30.2	68.5	49.7	155.0	12.5	14.8	0.452	JR45x50x25
	50	62	34	50	71	13	11	1.3	RAXZ 550	—	—	4 000	30.2	68.5	51.0	157.0	9.60	7.25	0.232	IM 45 50 25 P
60	60	72	36	60	86	15	11	1.3	RAXZ 560	—	—	3 500	31.9	78.1	71.0	255.0	11.5	18.4	0.327	IM 55 60 25 P
70	70	85	36	70	96	15	11	1.3	RAXZ 570	—	—	3 000	36.1	84.7	77.0	295.0	13.3	21.2	0.435	IM 60 70 25 P

Needle roller bearings, accessories
inner rings
metric series

Shaft dia. 5 ~ (10) mm

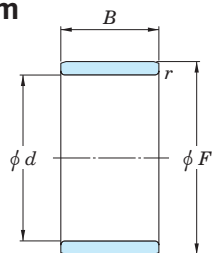

JR, IM..P

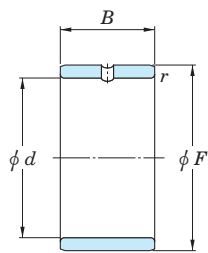

JR.JS1

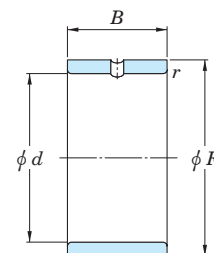

JRZ.JS1

Shaft dia. (10) ~ (15) mm

Shaft dia.	Boundary dimensions (mm)				Bearing No.	(Refer.) Mass (kg)
	d	F	B	r _{min.}		
5	5	8	8	0.3	JR5x8x8JS1	0.002
	5	8	12	0.3	JR5x8x12	0.003
	5	8	16	0.3	JR5x8x16	0.004
6	6	9	8	0.3	JR6x9x8JS1	0.002
	6	9	12	0.3	JR6x9x12	0.003
	6	9	16	0.3	JR6x9x16	0.004
	6	10	10	0.3	JR6x10x10	0.004
	6	10	10	0.3	JR6x10x10JS1	0.004
	6	10	12	0.3	JRZ6x10x12JS1	0.005
	6	10	12	0.3	JR6x10x12	0.004
7	7	10	10.5	0.3	JR7x10x10,5	0.003
	7	10	12	0.3	JR7x10x12	0.004
	7	10	16	0.3	JR7x10x16	0.005
8	8	12	10	0.3	JR8x12x10	0.005
	8	12	10	0.3	JR8x12x10JS1	0.005
	8	12	10.5	0.3	JR8x12x10,5	0.005
	8	12	12	0.3	JRZ8x12x12JS1	0.006
	8	12	12.5	0.3	JR8x12x12,5	0.006
	8	12	16	0.3	IM 8 12 16 P	0.007
	8	12	16	0.3	JR8x12x16	0.006
9	9	12	12	0.3	JR9x12x12	0.005
	9	12	16	0.3	JR9x12x16	0.006
10	10	13	12.5	0.3	JR10x13x12,5	0.005
	10	14	11	0.3	JR10x14x11JS1	0.007
	10	14	12	0.3	JR10x14x12	0.007
	10	14	12	0.3	JR10x14x12JS1	0.007
	10	14	13	0.3	JR10x14x13	0.007
	10	14	14	0.3	JRZ10x14x14JS1	0.008
	10	14	14	0.3	JR10x14x14	0.008
	10	14	16	0.3	JR10x14x16	0.009

[Note] 1) Please contact JTEKT about outside diameter tolerance.

Shaft dia.	Boundary dimensions (mm)				Bearing No.	(Refer.) Mass (kg)
	d	F	B	r _{min.}		
10	10	14	20	0.3	JR10x14x20	0.012
12	12	15	12.5	0.3	JR12x15x12,5	0.006
	12	15	16	0.3	JR12x15x16	0.008
	12	15	16.5	0.3	JR12x15x16,5	0.008
	12	15	18.5	0.3	JR12x15x18,5	0.009
	12	15	22.4	0.2	IM 12 15 22,4 P	0.011
	12	15	22.5	0.3	JR12x15x22,5	0.011
	12	16	12	0.3	JR12x16x12	0.008
	12	16	12	0.3	JR12x16x12JS1	0.008
	12	16	13	0.3	JR12x16x13	0.008
	12	16	14	0.3	JRZ12x16x14JS1	0.010
	12	16	16	0.3	JR12x16x16	0.011
	12	16	20	0.3	JR12x16x20	0.014
12	16	22	0.3	JR12x16x22	0.015	
13	13	18	16	0.35	IM 13 18 16 P	0.015
14	14	17	17	0.3	JR14x17x17	0.009
15	15	18	16.5	0.3	JR15x18x16,5	0.010
	15	19	16	0.3	JR15x19x16	0.013
	15	19	20	0.3	JR15x19x20	0.017
	15	20	12	0.3	JR15x20x12	0.012
	15	20	12	0.3	JR15x20x12JS1	0.012
	15	20	13	0.3	JR15x20x13	0.014
	15	20	14	0.3	JRZ15x20x14JS1	0.015
	15	20	16	0.3	JR15x20x16	0.017
	15	20	20	0.35	IM 15 20 20 P	0.021
	15	20	23	0.3	JR15x20x23	0.025

[Note] 1) Please contact JTEKT about outside diameter tolerance.

Needle roller bearings, accessories
inner rings
metric series

Shaft dia. (15) ~ (20) mm

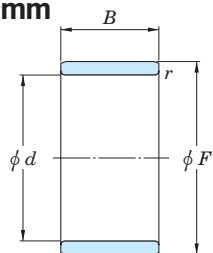

JR, IM..P

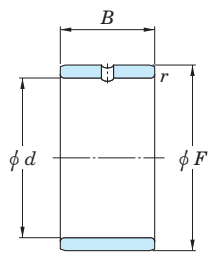

JR.JS1

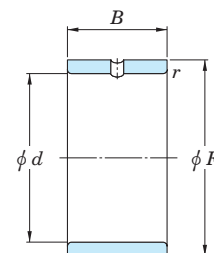

JRZ.JS1

Shaft dia. (20) ~ (30) mm

Shaft dia.	Boundary dimensions (mm)				Bearing No.	(Refer.) Mass (kg)
	d	F	B	r _{min.}		
15	15	20	26	0.3	JR15x20x26	0.028
17	17	20	16.5	0.3	JR17x20x16,5	0.011
	17	20	20	0.3	JR17x20x20	0.014
	17	20	20.5	0.3	JR17x20x20,5	0.014
	17	20	30.5	0.3	JR17x20x30,5	0.021
	17	21	16	0.3	JR17x21x16	0.015
	17	21	20	0.3	JR17x21x20	0.019
	17	22	13	0.3	JR17x22x13	0.015
	17	22 ¹⁾	13	0.35	IM 4903	0.015
	17	22	16	0.3	JR17x22x16	0.019
	17	22	16	0.3	JR17x22x16JS1	0.019
	17	22	16	0.3	JRZ17x22x16JS1	0.019
	17	22	20	0.35	IM 17 22 20 P	0.023
	17	22	23	0.3	JR17x22x23	0.028
	17	22	26	0.3	JR17x22x26	0.031
17	22	32	0.3	JR17x22x32	0.038	
20	20	24	16	0.3	JR20x24x16	0.018
	20	24	20	0.3	JR20x24x20	0.022
	20	25	16	0.3	JR20x25x16	0.022
	20	25	16	0.3	JR20x25x16JS1	0.022
	20	25	17	0.3	JR20x25x17	0.023
	20	25	18	0.3	JRZ20x25x18JS1	0.025
	20	25	20	0.3	JR20x25x20	0.028
	20	25	20.5	0.3	JR20x25x20,5	0.029
	20	25	26	0.3	JR20x25x26	0.036
	20	25	26.5	0.3	JR20x25x26,5	0.037
	20	25	30	0.3	JR20x25x30	0.042
	20	25	32	0.3	JR20x25x32	0.044

[Note] 1) Please contact JTEKT about outside diameter tolerance.

Shaft dia.	Boundary dimensions (mm)				Bearing No.	(Refer.) Mass (kg)
	d	F	B	r _{min.}		
20	20	25	38.5	0.3	JR20x25x38,5	0.054
22	22	26	16	0.3	JR22x26x16	0.019
	22	26	20	0.3	JR22x26x20	0.023
	22	28	17	0.3	JR22x28x17	0.030
	22	28	20.5	0.3	JR22x28x20,5	0.038
	22	28	30	0.3	JR22x28x30	0.056
23	23	28	20	0.35	IM 23 28 20 P	0.030
25	25	29	20	0.3	JR25x29x20	0.027
	25	29	30	0.3	JR25x29x30	0.040
	25	30	16	0.3	JR25x30x16	0.027
	25	30	16	0.3	JR25x30x16JS1	0.027
	25	30	17	0.3	JR25x30x17	0.028
	25	30	18	0.3	JRZ25x30x18JS1	0.031
	25	30	20	0.3	JR25x30x20	0.034
	25	30	20.5	0.3	JR25x30x20,5	0.035
	25	30	26	0.3	JR25x30x26	0.044
	25	30	26.5	0.3	JR25x30x26,5	0.045
	25	30	30	0.3	JR25x30x30	0.051
	25	30	32	0.3	JR25x30x32	0.054
	25	30	38.5	0.3	JR25x30x38,5	0.066
28	28	32	17	0.3	JR28x32x17	0.028
	28	32	20	0.3	JR28x32x20	0.030
	28	32	30	0.3	JR28x32x30	0.044
30	30	35	16	0.3	JR30x35x16	0.031
	30	35	17	0.3	JR30x35x17	0.033
	30	35 ¹⁾	17	0.35	IM 4906	0.033

[Note] 1) Please contact JTEKT about outside diameter tolerance.

Needle roller bearings, accessories
inner rings
metric series

Shaft dia. (30) ~ 38 mm

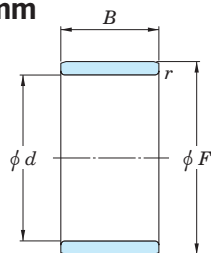

JR, IM..P

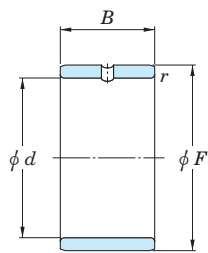

JR.JS1

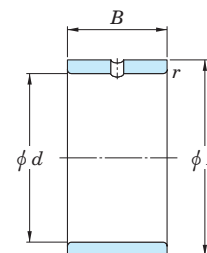

JRZ.JS1

Shaft dia. 40 ~ 45 mm

Shaft dia.	Boundary dimensions (mm)				Bearing No.	(Refer.) Mass (kg)
	d	F	B	r min.		
30	30	35	18	0.3	JRZ30x35x18JS1	0.036
	30	35	20	0.3	JR30x35x20	0.039
	30	35	20	0.3	JRZ30x35x20JS1	0.039
	30	35	20.5	0.3	JR30x35x20,5	0.040
	30	35	26	0.3	JR30x35x26	0.054
	30	35	30	0.3	JR30x35x30	0.057
	30	35	32	0.3	JR30x35x32	0.062
	30	38	20	0.6	JR30x38x20JS1	0.067
32	32	37	20	0.3	JR32x37x20	0.043
	32	37	30	0.3	JR32x37x30	0.064
	32	40	20	0.6	JR32x40x20	0.069
	32	40	36	0.6	JR32x40x36	0.128
35	35	40	17	0.3	JR35x40x17	0.040
	35	40	20	0.3	JR35x40x20	0.046
	35	40	20.5	0.3	JR35x40x20,5	0.049
	35	40	22	0.3	JR35x40x22	0.052
	35	40	30	0.3	JR35x40x30	0.071
	35	40	34	0.3	JR35x40x34	0.080
	35	40	40	0.3	JR35x40x40	0.094
	35	42	20	0.6	JR35x42x20	0.065
	35	42	20	0.6	JR35x42x20JS1	0.065
	35	42	23	0.6	JRZ35x42x23JS1	0.074
	35	42	36	0.6	JR35x42x36	0.122
	35	44	22	0.6	JR35x44x22	0.097
37	37	42	20	0.35	IM 37 42 20 P	0.046
38	38	43	20	0.3	JR38x43x20	0.050
	38	43	30	0.3	JR38x43x30	0.075

[Note] 1) Please contact JTEKT about outside diameter tolerance.

Shaft dia.	Boundary dimensions (mm)				Bearing No.	(Refer.) Mass (kg)
	d	F	B	r min.		
40	40	45	17	0.3	JR40x45x17	0.044
	40	45	20	0.3	JR40x45x20	0.052
	40	45	20.5	0.3	JR40x45x20,5	0.054
	40	45	25	0.35	IM 40 45 25 P	0.062
	40	45	30	0.3	JR40x45x30	0.078
	40	45	34	0.3	JR40x45x34	0.089
	40	45	40	0.3	JR40x45x40	0.115
	40	48	22	0.6	JR40x48x22	0.094
	40	48	23	0.6	JRZ40x48x23JS1	0.100
	40	48	40	0.6	JR40x48x40	0.173
42	42	47	20	0.3	JR42x47x20	0.055
	42	47	30	0.3	JR42x47x30	0.083
45	45	50	20	0.3	JR45x50x20	0.058
	45	50	25	0.6	JR45x50x25	0.073
	45	50	25.5	0.3	JR45x50x25,5	0.075
	45	50	35	0.6	JR45x50x35	0.103
	45	50	40	0.3	JR45x50x40	0.117
	45	52	22	0.6	JR45x52x22	0.090
	45	52 ¹⁾	22	0.85	IM 4909	0.087
	45	52	23	0.6	JR45x52x23	0.096
	45	52	23	0.6	JRZ45x52x23JS1	0.096
	45	52	40	0.6	JR45x52x40	0.167
	45	55	20	1	JR45x55x20	0.133
	45	55	20	1	JR45x55x20JS1	0.133
45	55	22	1	JR45x55x22	0.135	
45	55	40	1	JR45x55x40	0.247	

[Note] 1) Please contact JTEKT about outside diameter tolerance.

Needle roller bearings, accessories
inner rings
metric series

Shaft dia. 50 ~ 60 mm

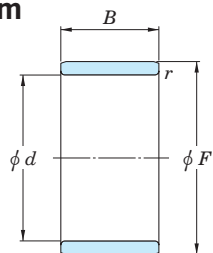

JR, IM..P

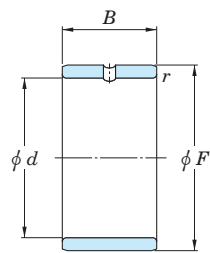

JR.JS1

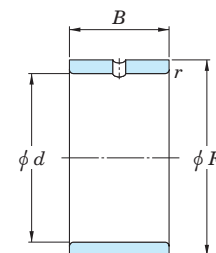

JRZ.JS1

Shaft dia. 65 ~ (90) mm

Shaft dia.	Boundary dimensions (mm)				Bearing No.	(Refer.) Mass (kg)
	d	F	B	r min.		
50	50	55	20	0.3	JR50x55x20	0.065
	50	55	25	0.6	JR50x55x25	0.081
	50	55	35	0.65	IM 50 55 35 P	0.107
	50	55	35	0.6	JR50x55x35	0.113
	50	55	40	0.3	JR50x55x40	0.130
	50	58	22	0.6	JR50x58x22	0.117
	50	58	23	0.6	JRZ50x58x23JS1	0.122
	50	58	40	0.6	JR50x58x40	0.213
	50	60	20	1	JR50x60x20	0.155
	50	60	20	1	JR50x60x20JS1	0.155
	50	60	25	1	JR50x60x25	0.170
	50	60	40	1	JR50x60x40	0.310
	55	55	60	25	0.6	JR55x60x25
55		60	35	0.65	IM 55 60 35 P	0.118
55		60	35	0.6	JR55x60x35	0.124
55		63	25	1	JR55x63x25	0.141
55		63	45	1	JR55x63x45	0.286
55		65	30	1	JR55x65x30	0.222
55		65	60	1	JR55x65x60	0.444
58		65	25	0.85	IM 58 65 25 P	0.125
60	60	68	25	0.6	JR60x68x25	0.153
	60	68	35	0.6	JR60x68x35	0.220
	60	68	45	1	JR60x68x45	0.284
	60	70	25	1	JR60x70x25	0.200
	60	70	30	1	JR60x70x30	0.240
	60	70	35	0.85	IM 60 70 35 P	0.280
	60	70	60	1	JR60x70x60	0.480

[Note] 1) Please contact JTEKT about outside diameter tolerance.

Shaft dia.	Boundary dimensions (mm)				Bearing No.	(Refer.) Mass (kg)
	d	F	B	r min.		
65	65	72	25	1	JR65x72x25	0.143
	65	72	45	1	JR65x72x45	0.266
	65	73	25	0.6	JR65x73x25	0.170
	65	73	35	0.6	JR65x73x35	0.240
	65	75	28	1	JR65x75x28	0.240
	65	75	30	1	JR65x75x30	0.260
	65	75	60	1	JR65x75x60	0.520
	70	80	25	1	JR70x80x25	0.230
70	70	80	30	1	JR70x80x30	0.270
	70	80	35	1	JR70x80x35	0.320
	70	80	54	1	JR70x80x54	0.500
70	70	80	60	1	JR70x80x60	0.556
	75	85	25	1	JR75x85x25	0.240
75	75	85	30	1	JR75x85x30	0.289
	75	85	35	1	JR75x85x35	0.338
	75	85	54	1	JR75x85x54	0.530
80	80	90	25	1	JR80x90x25	0.260
	80	90	30	1	JR80x90x30	0.306
	80	90	35	1	JR80x90x35	0.355
	80	90	54	1	JR80x90x54	0.565
85	85	95	26	1	JR85x95x26	0.290
	85	95	30	1	JR85x95x30	0.334
	85	95	36	1	JR85x95x36	0.397
	85	100	35	1.1	JR85x100x35	0.595
85	85	100	63	1.1	JR85x100x63	1.080
	90	100	26	1	JR90x100x26	0.300

[Note] 1) Please contact JTEKT about outside diameter tolerance.

Needle roller bearings, accessories
inner rings
metric series

Shaft dia. (90) ~ 170 mm

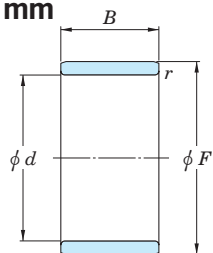

JR, IM..P

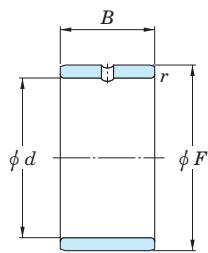

JR.JS1

Shaft dia. 180 mm

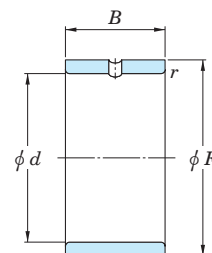

JRZ.JS1

Shaft dia.	Boundary dimensions (mm)				Bearing No.	(Refer.) Mass (kg)
	d	F	B	r min.		
90	90	100	30	1	JR90x100x30	0.350
	90	100	36	1	JR90x100x36	0.422
	90	105	32	1.1	JR90x105x32	0.580
	90	105	35	1.1	JR90x105x35	0.624
	90	105	63	1.1	JR90x105x63	1.140
95	95	105	26	1	JR95x105x26	0.310
	95	105	36	1	JR95x105x36	0.430
	95	110	35	1.1	JR95x110x35	0.653
	95	110	63	1.1	JR95x110x63	1.200
100	100	110	30	1.1	JR100x110x30	0.384
	100	110	40	1.1	JR100x110x40	0.510
	100	115	40	1.1	JR100x115x40	0.790
110	110	120	30	1	JR110x120x30	0.425
	110	125	40	1.1	JR110x125x40	0.870
120	120	130	30	1	JR120x130x30	0.460
	120	135	45	1.1	JR120x135x45	1.060
130	130	145	35	1.1	JR130x145x35	0.890
	130	150	50	1.5	JR130x150x50	1.730
140	140	155	35	1.1	JR140x155x35	0.955
	140	160	50	1.5	JR140x160x50	1.860
150	150	165	40	1.1	JR150x165x40	1.170
160	160	175	40	1.1	JR160x175x40	1.240
170	170	185	45	1.1	JR170x185x45	1.480

[Note] 1) Please contact JTEKT about outside diameter tolerance.

Shaft dia.	Boundary dimensions (mm)				Bearing No.	(Refer.) Mass (kg)
	d	F	B	r min.		
180	180	195	45	1.1	JR180x195x45	1.560

[Note] 1) Please contact JTEKT about outside diameter tolerance.

Needle roller bearings, accessories
inner rings for machine-tool quality precision-combined bearings
metric series

Shaft dia. 17 ~ 45 mm

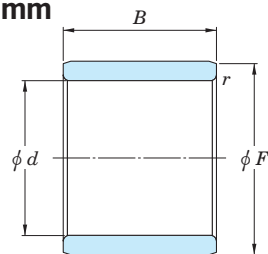

IM

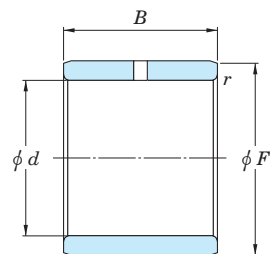

IMC

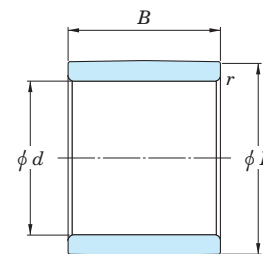

IM...R6

Shaft dia.	Boundary dimensions (mm)				Bearing No.	(Refer.) Mass (kg)
	d	F ¹⁾	B	r _{min.}		
17	17	20	27.5	0.2	IM 19017 IM 20617	0.019 0.021
	17	20	32	0.2		
20	20	25	27.5	0.35	IM 19020 IM 20620	0.038 0.044
	20	25	32	0.35		
25	25	30	27.5	0.35	IM 19025 IM 20625	0.042 0.052
	25	30	32	0.35		
30	30	35	27.5	0.35	IM 19030 IM 20630	0.053 0.061
	30	35	32	0.35		
35	35	40	27.5	0.35	IM 19035 IM 20635	0.063 0.072
	35	40	32	0.35		
40	40	45	27.5	0.35	IM 19040 IM 20640	0.069 0.080
	40	45	32	0.35		
45	45	50	30.5	0.65	IM 19045 IM 20645	0.085 0.096
	45	50	35	0.65		

[Note] 1) Please contact JTEKT about outside diameter tolerance.

**Heavy-duty needle roller bearings
inner rings
inch series**

Shaft dia. $\frac{3}{8} \sim 1 \frac{5}{16}$ in
(9.525 ~ 33.338 mm)

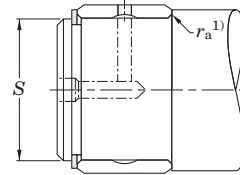
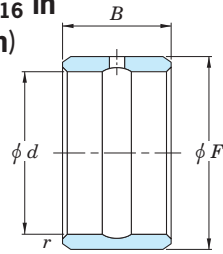

Shaft dia. $1 \frac{3}{8} \sim (2 \frac{1}{2})$ in
(34.925 ~ (63.500) mm)

Shaft dia. (in)	Boundary dimensions (mm)				Inner ring No.	(Refer.) Mass (kg)	Shaft dia. (mm)				Used with bearing No.
	d	F	B	r min.			Loose transition fit max.	min.	Interference fit max.	min.	
$\frac{3}{8}$	9.525	15.875	19.05	0.64	IR-061012	0.018	9.520	9.510	9.538	9.530	HJ-101812
$\frac{1}{2}$	12.700	19.050	19.05	1.02	IR-081212	0.023	12.692	12.682	12.715	12.708	HJ-122012
	12.700	19.050	25.40	1.02	IR-081216	0.032	12.692	12.682	12.715	12.708	HJ-122016
$\frac{5}{8}$	15.875	22.225	19.05	1.02	IR-101412	0.027	15.867	15.857	15.890	15.883	HJ-142212
	15.875	22.225	25.40	1.02	IR-101416	0.036	15.867	15.857	15.890	15.883	HJ-142216
$1 \frac{1}{16}$	17.463	22.225	19.05	1.02	IR-111412	0.023	17.455	17.445	17.478	17.470	HJ-142212
$\frac{3}{4}$	19.050	25.400	19.05	1.02	IR-121612	0.032	19.042	19.030	19.068	19.058	HJ-162412
	19.050	25.400	25.40	1.02	IR-121616	0.041	19.042	19.030	19.068	19.058	HJ-162416
$1 \frac{3}{16}$	20.638	25.400	25.40	1.02	IR-131616	0.032	20.630	20.617	20.655	20.645	HJ-162416
$\frac{7}{8}$	22.225	28.575	25.40	1.02	IR-141816	0.050	22.217	22.205	22.243	22.233	HJ-182616
	22.225	28.575	31.75	1.02	IR-141820	0.059	22.217	22.205	22.243	22.233	HJ-182620
$1 \frac{5}{16}$	23.813	28.575	25.40	1.02	IR-151816	0.036	23.805	23.792	23.830	23.820	HJ-182616
	23.813	28.575	31.75	1.02	IR-151820	0.045	23.805	23.792	23.830	23.820	HJ-182620
1	25.400	31.750	25.40	1.02	IR-162016	0.054	25.392	25.380	25.418	25.408	HJ-202816
	25.400	31.750	31.75	1.02	IR-162020	0.068	25.392	25.380	25.418	25.408	HJ-202820
$1 \frac{1}{8}$	28.575	34.925	25.40	1.02	IR-182216	0.059	28.567	28.555	28.593	28.583	HJ-223016
	28.575	34.925	31.75	1.02	IR-182220	0.077	28.567	28.555	28.593	28.583	HJ-223020
$1 \frac{1}{16}$	30.163	38.100	31.75	1.52	IR-192420	0.100	30.155	30.142	30.180	30.170	HJ-243320
$1 \frac{1}{4}$	31.750	38.100	25.40	1.52	IR-202416	0.068	31.740	31.725	31.770	31.760	HJ-243316
	31.750	38.100	31.75	1.52	IR-202420	0.082	31.740	31.725	31.770	31.760	HJ-243320
$1 \frac{5}{16}$	33.338	41.275	25.40	1.52	IR-212616	0.086	33.327	33.312	33.358	33.348	HJ-263516
	33.338	41.275	31.75	1.52	IR-212620	0.109	33.327	33.312	33.358	33.348	HJ-263520

[Note] 1) $r_{a \max}$ is equal to the minimum bearing chamfer ($r_{s \min}$).

Shaft dia. (in)	Boundary dimensions (mm)				Inner ring No.	(Refer.) Mass (kg)	Shaft dia. (mm)				Used with bearing No.
	d	F	B	r min.			Loose transition fit max.	min.	Interference fit max.	min.	
$1 \frac{3}{8}$	34.925	41.275	31.75	1.52	IR-222620	0.091	34.915	34.900	34.945	34.935	HJ-263520
	34.925	44.450	31.75	1.52	IR-222820	0.141	34.915	34.900	34.945	34.935	HJ-283720
$1 \frac{7}{16}$	36.513	44.450	25.40	1.52	IR-232816	0.095	36.502	36.487	36.533	36.523	HJ-283716
	36.513	44.450	31.75	1.52	IR-232820	0.118	36.502	36.487	36.533	36.523	HJ-283720
$1 \frac{1}{2}$	38.100	44.450	25.40	1.52	IR-242816	0.077	38.090	38.075	38.120	38.110	HJ-283716
	38.100	44.450	31.75	1.52	IR-242820	0.095	38.090	38.075	38.120	38.110	HJ-283720
	38.100	50.800	31.75	1.52	IR-243220	0.209	38.090	38.075	38.120	38.110	HJ-324120
$1 \frac{9}{16}$	39.688	47.625	31.75	1.52	IR-253020	0.127	39.677	39.662	39.708	39.698	HJ-303920
	39.688	50.800	31.75	1.52	IR-253220	0.186	39.677	39.662	39.708	39.698	HJ-324120
$1 \frac{5}{8}$	41.275	50.800	31.75	1.52	IR-263220	0.163	41.265	41.250	41.295	41.285	HJ-324120
$1 \frac{11}{16}$	42.863	50.800	25.40	1.52	IR-273216	0.109	42.852	42.837	42.883	42.873	HJ-324116
	42.863	50.800	31.75	1.52	IR-273220	0.136	42.852	42.837	42.883	42.873	HJ-324120
$1 \frac{3}{4}$	44.450	57.150	38.10	1.52	IR-283624	0.286	44.440	44.425	44.470	44.460	HJ-364824
	44.450	57.150	44.45	1.52	IR-283628	0.336	44.440	44.425	44.470	44.460	HJ-364828
$1 \frac{15}{16}$	49.213	63.500	38.10	2.03	IR-314024	0.358	49.202	49.187	49.233	49.223	HJ-405224
	49.213	63.500	44.45	2.03	IR-314028	0.417	49.202	49.187	49.233	49.223	HJ-405228
2	50.800	63.500	38.10	2.03	IR-324024	0.322	50.790	50.772	50.823	50.810	HJ-405224
	50.800	63.500	44.45	2.03	IR-324028	0.376	50.790	50.772	50.823	50.810	HJ-405228
$2 \frac{3}{16}$	55.563	69.850	44.45	2.03	IR-354428	0.467	55.552	55.535	55.585	55.573	HJ-445628
$2 \frac{1}{4}$	57.150	69.850	38.10	2.03	IR-364424	0.358	57.140	57.122	57.173	57.160	HJ-445624
	57.150	69.850	44.45	2.03	IR-364428	0.417	57.140	57.122	57.173	57.160	HJ-445628
$2 \frac{3}{8}$	60.325	76.200	44.45	2.03	IR-384828	0.562	60.315	60.297	60.348	60.335	HJ-486028
$2 \frac{1}{2}$	63.500	76.200	38.10	2.03	IR-404824	0.395	63.490	63.472	63.523	63.510	HJ-486024

Heavy-duty needle roller bearings
inner rings
inch series

Shaft dia. (2 1/2) ~ 3 in
 ((63.500) ~ 76.200 mm)

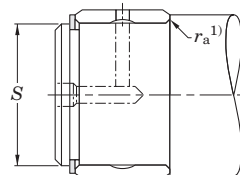
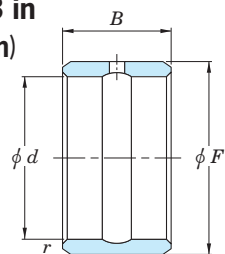

Shaft dia. (in)	Boundary dimensions (mm)				Inner ring No.	(Refer.) Mass (kg)	Shaft dia. (mm)				Used with bearing No.
	d	F	B	r min.			Loose transition fit		Interference fit		
							max.	min.	max.	min.	
2 1/2	63.500	76.200	44.45	2.03	IR-404828	0.463	63.490	63.472	63.523	63.510	HJ-486028
2 3/4	69.850	82.550	44.45	2.03	IR-445228	0.503	69.840	69.822	69.873	69.860	HJ-526828
	69.850	82.550	50.80	2.03	IR-445232	0.576	69.840	69.822	69.873	69.860	HJ-526832
2 15/16	74.613	88.900	50.80	2.03	IR-475632	0.694	74.602	74.585	74.635	74.623	HJ-567232
3	76.200	88.900	50.80	2.03	IR-485632	0.621	76.190	76.172	76.223	76.210	HJ-567232

[Note] 1) $r_{a \max}$ is equal to the minimum bearing chamfer ($r_{s \min}$).

Miniature one-way clutches

Miniature one-way clutches consist of a case carburizing steel drawn cup, metal or synthetic resin spring, synthetic resin cage and needle rollers.

They are used in clutch mechanisms of various machines. Use in office automation equipment such as copying and facsimile machines is especially common.

- Useful for making equipment smaller and lighter, due to a drawn cup made of thin sheet steel.
- Locking protrusions are provided around the drawn cup, so that creeping can be prevented without having to hold the surface dimensional accuracy precisely.
- Pre-lubricated with optimum grease, so that no lubrication is necessary under normal operating conditions.
- Unit products with a synthetic resin housing are also available. They are compatible with components of various types, such as gears, timing pulleys, cams and rubber rollers. Consult with JTEKT for further information.



1WC series



EWC series



Various housings and unit products

Structure and principles

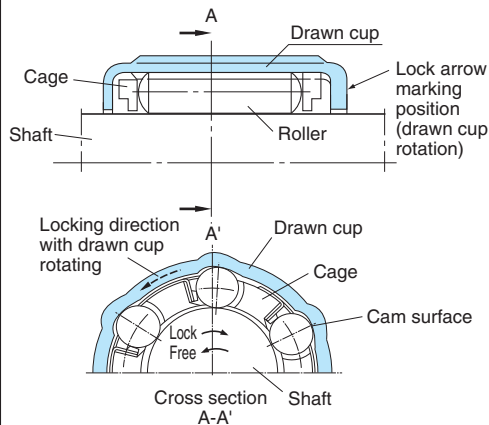

[When the clutch system works]

When the shaft rotates clockwise as in cross section A-A', rollers are locked while engaged with the drawn cup cam surfaces by the effect of springs (wedging of the shaft by the cam surfaces). The drawn cup is driven as a consequence.

[Clutch idle running]

When the shaft rotates counter-clockwise as in cross section A-A', rollers move away from the drawn cup cam surfaces and rotate freely.

Miniature one-way clutch types and characteristics

	1WC series (with metal springs)		EWC series (with synthetic resin springs)	
	Heavy load type		Heavy load type	Light load type
	1WC...		EWC...C	EWC...A
Torque capacity	Heavy load		Heavy load	Light load
Operating temperature range	- 10 to + 90°C		- 10 to + 70°C	
Locking life	Locking system can function more than one million. (Note : this estimation is valid as long as torque magnitude does not exceed the torque capacity shown in the specification table.)			
Insert molding	Possible		Impossible	
Delivery of clutch only	Possible			
Unit delivery	Possible			

Shaft tolerance

	Heavy load type (1WC..., EWC...C)	Light load type (EWC...A)
Shaft tolerance class	h 8	
Surface hardness	50 HRC or harder	30 HRC or harder
Roughness (Ra)	0.3 a or less	0.8 a or less
Roundness and cylindricity	0.005 mm or less	

[Remarks] In some operating conditions, shafts need not be as accurate as shown here.

For example :

1. When clutch engaging accuracy is considered unimportant, or when a radial load or moment is not generated, the shaft diameter tolerance can be :
 - shaft diameter 6 mm or less, and EWC0809 (C, A) : 0 to - 0.040 mm
 - shaft diameter 8 mm or more : h 10
2. When the loaded torque is smaller than the torque capacity, shaft surface hardness can be determined as follows :

* The diagram on the right shows approximate shaft surface hardness relative to torque ratio A.

$$\text{Torque ratio (A)} = \frac{\text{Loaded torque}}{\text{Heavy load type torque capacity}}$$

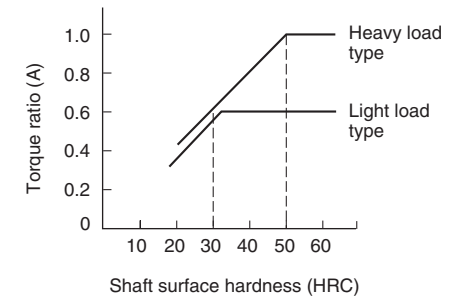

Miniature one-way clutches

d 4 ~ 12 mm

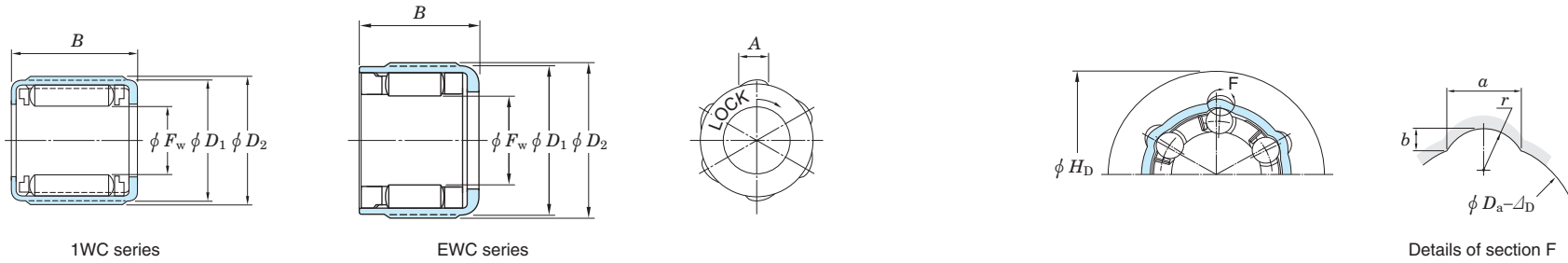

Shaft dia. (mm)	Boundary dimensions (mm)					Torque capacity (N·m)	Designations		No. of ¹⁾ outer ring protrusion	Recommended housing dimensions (mm)						(Refer.) Mass (g)	
	F _w	D ₁	D ₂	B	A		1WC series (With metal springs)	EWC series (With resin springs)		H _D	a	b	r	D _a	∠D ²⁾	1WC	EWC
4	4	8	8.4	6	2.6	0.08	—	EWC0406A	4	12	2.65	0.50	2	8	0.06	—	1.0
	4	8	8.4	6	2.6	0.15	—	EWC0406C	4	12	2.65	0.50	2	8	0.06	—	1.0
6	6	10	10.4	8	2.8	0.25	—	EWC0608A	6	14	2.8	0.57	2	10	0.08	—	1.7
	6	10	10.4	8	2.8	0.44	—	EWC0608C	6	14	2.8	0.57	2	10	0.08	—	1.7
	6	10	10.4	8	2.8	0.44	1WC0608	—	6	14	2.8	0.57	2	10	0.08	2.0	—
	6	10	10.4	12	2.8	0.88	1WC0612	—	6	14	2.8	0.57	2	10	0.08	3.0	—
8	8	12	12.4	9	2.6	0.49	—	EWC0809A	6	16	2.6	0.48	2	12	0.10	—	2.4
	8	12	12.4	9	2.6	0.88	—	EWC0809C	6	16	2.6	0.48	2	12	0.10	—	2.4
	8	14.2	15	12	3.6	1.18	—	EWC0812A	6	18.5	3.6	0.87	2.3	14.2	0.11	—	5.8
	8	14.2	15	12	3.6	1.96	—	EWC0812C	6	18.5	3.6	0.87	2.3	14.2	0.11	—	5.8
	8	14.2	15	12	3.6	1.96	1WC0812	—	6	18.5	3.6	0.87	2.3	14.2	0.11	7.0	—
	8	14.2	15	14.5	3.6	2.65	1WC0815	—	6	18.5	3.6	0.87	2.3	14.2	0.11	8.0	—
10	10	16	17	10	5	1.18	—	EWC1010A	6	21	5.0	1.20	3.2	16	0.13	—	6.0
	10	16	17	10	5	1.96	—	EWC1010C	6	21	5.0	1.20	3.2	16	0.13	—	6.0
	10	16	17	12	5	1.37	—	EWC1012A	6	21	5.0	1.20	3.2	16	0.13	—	6.8
	10	16	17	12	5	2.35	—	EWC1012C	6	21	5.0	1.20	3.2	16	0.13	—	6.8
	10	16	17	12	5	2.35	1WC1012	—	6	21	5.0	1.20	3.2	16	0.13	8.0	—
12	12	18	19	16	5.1	6.28	1WC1216	—	8	23	5.1	1.20	3.3	18	0.14	12	—

[Notes] 1) Provided at equal intervals.
2) Recommended interference when polyacetal resin housing is used.

Ball bearing units

Ball bearing units consist of pre-lubricated sealed ball bearings and a housing which varies in shape.

They are capable of aligning themselves efficiently using the spherical fitting surface between the bearing and housing, effectively preventing overloads due to misalignment.



Pillow block type



Flanged type

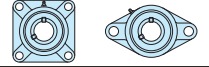

Flanged type with spigot joint



Take-up type



Cartridge type



Light duty units



"Compact" series (made from light alloy)



Stainless-series



Pressed steel units



Ball bearings for units

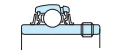

For details, refer to JTEKT separate catalog "Ball bearing units" (CAT. NO. B2007E).



K-series super thin section ball bearings

Koyo K-series super thin section ball bearings were developed to meet current engineering needs for thinner, lighter bearings. They are used extensively in automation and labor saving equipment, such as industrial robots.

These bearings are sorted into nine dimension series according to cross-sectional area.

Those of the same dimension series have an equivalent cross-sectional area irrespective of the bore diameter.

They are available in three types that differ in structure.

■ Deep groove type

Carries radial load, axial load in both directions, and combined loads.

■ Angular contact type

Has a 30° contact angle, and carries radial load and axial load in one direction.

Two bearings are usually used together facing one another.

■ Four-point contact type

Has a contact angle of 30° both to the right and to the left.

Able to carry axial load in both directions. Also able to support moment and radial loads.



Dimension series code	Cross-sectional dimension $B = E$ (mm)	Bearing type code			Bore diameter (mm)
		C (Deep groove type)	A (Angular contact type)	X (Four-point contact type)	
T	4.762	KTC	KTA	KTX	25.4 to 38.1
A	6.35	KAC	KAA	KAX	50.8 to 304.8
B	7.938	KBC	KBA	KBX	50.8 to 508
C	9.525	KCC	KCA	KCX	101.6 to 762
D	12.7	KDC	KDA	KDX	
F	19.05	KFC	KFA	KFX	101.6 to 1016
G	25.4	KGC	KGA	KGX	
J	$B = 11.1$ $E = 9.525$	-	KJA...RD 	-	101.6 to 304.8
U	$B = 12.7$ $E = 9.525$	KUC...2RD 	-	KUX...2RD 	

Table 1 K-series super thin section ball bearings : tolerance

Bore diameter number	Single plane mean bore diameter deviation					Single plane mean outside diameter deviation					Single inner (outer) ring width deviation			Radial runout of assembled bearing ring, max.								Assembled bearing ring face runout with raceway, max.				Bore diameter number
	Δd_{mp}					ΔD_{mp}					$\Delta B_s, \Delta C_s$			Inner ring K_{ia}				Outer ring K_{ea}				Inner ring S_{ia}		Outer ring S_{ea}		
	classes K0, K1, K2		class K3	class K4	class K6	classes K0, K1, K2		class K3	class K4	class K6	classes K0, K1, K2	classes K3, K4	class K6	class K0	class K3	classes K1, K4	classes K2, K6	class K0	class K3	classes K1, K4	classes K2, K6	classes K1, K4	classes K0, K2, K3, K6	classes K1, K4	classes K0, K2, K3, K6	
	div. I	div. II				div. I	div. II							div. I	div. II											
010	0	-10	0	-5	0	-4							13	8	8										010	
015	0	-13	0	-8	0	-5							15	10											015	
020																									020	
025	0	-15	0	-10	0	-5							20	13	10	5	4								025	
030																									030	
035																									035	
040																									040	
042	0	-20	0	-13	0	-6							25		13										042	
045																									045	
047																									047	
050																									050	
055																									055	
060	0	-25	0	-15	0	-10	0	-8					30		15										060	
065																									065	
070																									070	
075																									075	
080	0	-30	0	-18	0	-10	0	-13					41	30	20	10									080	
090																									090	
100																									100	
110	0	-36	0	-20	0	-13	0	-20	0	-13			46	36	25	13	10								110	
120																									120	
140	0	-41	0	-23	0	-15	0	-15																	140	
160																									160	
180	0	-46	0	-23	0	-15	0	-18																	180	
200	0	-51	0	-25	0	-18	0	-20																	200	
250																									250	
300	0	-76	0	-46	0	-46	0	-46					51	46	41	20									300	
350																									350	
400	0	-102	0	-51	0	-102	0	-51																	400	

[Notes] Division I is for deep groove type ball bearings.
 Division II is for angular contact type and four-point contact type ball bearings.

Table 2 Standard radial internal clearance of deep groove and four-point contact type ball bearings Unit : μm

Bore diameter number	Radial internal clearance					
	classes K0, K1, K2		class K3	class K4	class K6	
	Deep groove type	Four-point contact type				
010	25 - 41	25 - 38	18 - 28	13 - 23	10 - 20	
015	30 - 46	30 - 43	20 - 30		13 - 23	
020	30 - 61	30 - 56	20 - 46	15 - 30	10 - 25	
025					15 - 30	
030						
035						
040	41 - 71	41 - 66	25 - 51	20 - 36	15 - 30	
042	41 - 71	41 - 66	25 - 51			
045						
047						
050	51 - 86	51 - 76	30 - 56	20 - 36	20 - 36	
055						
060						
065						
070						
075	61 - 107	61 - 86	36 - 61	25 - 41	25 - 41	
080						
089						
090						
100	71 - 122	71 - 97	41 - 66	30 - 46	25 - 41	
110						
120						
140	81 - 132	91 - 117	46 - 71	36 - 51	30 - 46	
160	91 - 142		81 - 107			51 - 76
180						
200	102 - 152		61 - 86			36 - 56
250	152 - 203	91 - 117	/	/	/	
300						
350						
400	203 - 254	102 - 127	/	/	/	

Table 3 Mounting dimensions

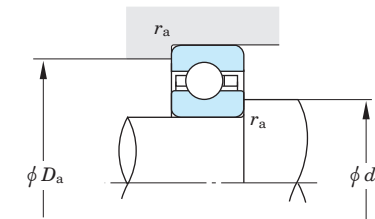

Unit : mm

Dimension series	Bearing type			ϕd_a		ϕD_a		r_a
				max.	min.	min.	max.	max.
T	KTC	KTA	KTX	$d + 5.3$	$d + 3.4$	$d + 4.2$	$d + 6.1$	0.2
A	KAC	KAA	KAX	$d + 7.3$	$d + 4.6$	$d + 5.4$	$d + 8.2$	0.4
B	KBC	KBA	KBX	$d + 9.3$	$d + 5.7$	$d + 6.6$	$d + 10.2$	0.8
C	KCC	KCA	KCX	$d + 11.3$	$d + 6.9$	$d + 7.7$	$d + 12.2$	0.8
D	KDC	KDA	KDX	$d + 15.3$	$d + 9.2$	$d + 10.1$	$d + 16.2$	1.3
F	KFC	KFA	KFX	$d + 23.3$	$d + 13.9$	$d + 14.8$	$d + 24.2$	1.8
G	KGC	KGA	KGX	$d + 31.3$	$d + 18.7$	$d + 19.5$	$d + 32.1$	1.8
J	-	KJA	-	$d + 11.3$	$d + 6.9$	$d + 7.7$	$d + 12.2$	0.2
U	KUC	-	KUX					

Table 4 Shaft diameter and housing bore diameter tolerance

Bore diameter number	Inner ring rotation										Outer ring rotation										Bore diameter number
	Shaft diameter tolerance					Housing bore diameter tolerance					Shaft diameter tolerance					Housing bore diameter tolerance					
	classes K0, K1, K2		class K3	class K4	class K6	classes K0, K1, K2		class K3	class K4	class K6	classes K0, K1, K2		class K3	class K4	class K6	classes K0, K1, K2		class K3	class K4	class K6	
	div. I	div. II				div. I	div. II				div. I	div. II				div. I	div. II				
010	+10 0		+5 0	+5 0	+4 0	+13 0		+8 0	+5 0		-10 -20	-5 -10	-5 -10	-4 -8	-13 -25		-8 -15	-5 -10			010
015	+13 0		+8 0				+13 0			+5 0						-13 -25	-13 -25			-5 -10	015
020					+5 0									-5 -10							020
025	+15 0		+10 0																		025
030						+15 0		+10 0	+8 0						-15 -30		-10 -20	-8 -15			030
035				+8 0			+15 0			+8 0											035
040	+20 0		+13 0		+6 0																040
042																					042
045						+20 0		+13 0	+10 0												045
047																					047
050																					050
055	+25 0		+15 0	+10 0	+8 0																055
060						+25 0		+15 0		+10 0											060
065																					065
070																					070
075																					075
080	+30 0		+18 0		+10 0			+18 0	+13 0												080
090				+13 0																	090
100	+35 0				+13 0	+35 0		+20 0		+13 0											100
110		+35 0	+20 0				+35 0														110
120																					120
140	+40 0					+40 0		+23 0	+15 0	+15 0											140
160	+45 0	+40 0	+23 0	+15 0		+45 0	+40 0	+25 0	+18 0												160
180																					180
200	+50 0		+25 0	+18 0		+50 0		+30 0	+20 0												200
250	+75 0	+45 0				+75 0	+45 0														250
300																					300
350	+100 0	+50 0				+100 0	+50 0														350
400																					400

[Notes] Division I is for deep groove type ball bearings.
Division II is for angular contact type and four-point contact type ball bearings.

K-series super thin section ball bearings
open type

d 25.4 ~ (114.3) mm

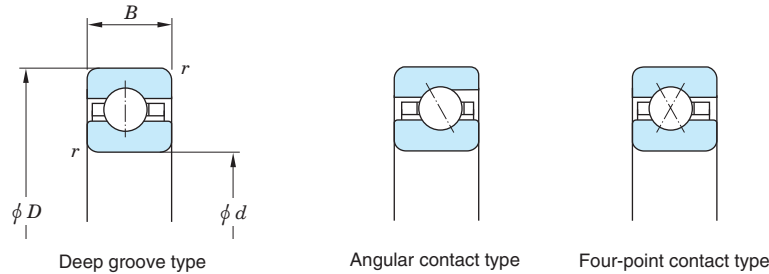

Boundary dimensions (mm)				Deep groove type			Angular contact type				Four-point contact type				(Refer.) Mass (kg)					
<i>d</i>	<i>D</i>	<i>B</i>	<i>r</i> min.	Bearing No.	Basic load ratings (kN)		Bearing No.	Basic load ratings (kN)			Bearing No.	Basic load ratings (kN)			Deep groove type	Angular contact type	Four-point contact type			
					<i>C_r</i>	<i>C_{0r}</i>		<i>C_r</i>	<i>C_{0r}</i>	<i>C_a</i>	<i>C_{0a}</i>		<i>C_r</i>	<i>C_{0r}</i>	<i>C_a</i>	<i>C_{0a}</i>				
25.4	34.925	4.762	0.4	KTC010	2.50	1.95	KTA010	2.65	2.20	3.45	6.70	KTX010	2.15	1.65	3.70	7.15	0.012	0.011	0.012	
38.1	47.625	4.762	0.4	KTC015	2.90	2.70	KTA015	3.05	3.10	4.00	9.35	KTX015	2.50	2.30	4.20	10.5	0.018	0.017	0.018	
50.8	63.5	6.35	0.6	KAC020	4.50	4.30	KAA020	4.75	4.95	6.25	14.9	KAX020	3.90	3.70	6.60	16.9	0.045	0.045	0.045	
	66.675	7.938	1	KBC020	6.35	5.85	KBA020	6.75	6.70	8.90	20.4	KBX020	5.55	5.00	9.35	22.0	0.073	0.068	0.073	
63.5	76.2	6.35	0.6	KAC025	4.85	5.20	KAA025	5.10	5.95	6.75	18.0	KAX025	4.20	4.45	7.05	20.9	0.059	0.054	0.059	
	79.375	7.938	1	KBC025	6.90	7.00	KBA025	7.35	8.15	9.65	24.6	KBX025	6.00	6.00	10.0	27.3	0.086	0.086	0.086	
76.2	88.9	6.35	0.6	KAC030	5.20	6.10	KAA030	5.45	7.00	7.15	21.2	KAX030	4.50	5.25	7.45	24.9	0.068	0.064	0.068	
	92.075	7.938	1	KBC030	7.35	8.15	KBA030	7.70	9.35	10.2	28.3	KBX030	6.35	7.00	10.6	32.5	0.109	0.100	0.109	
88.9	101.6	6.35	0.6	KAC035	5.45	7.00	KAA035	5.75	8.00	7.55	24.3	KAX035	4.75	6.00	7.80	29.0	0.082	0.077	0.082	
	104.775	7.938	1	KBC035	7.75	9.30	KBA035	8.20	10.7	10.8	32.5	KBX035	6.70	8.00	11.1	37.8	0.122	0.122	0.122	
101.6	114.3	6.35	0.6	KAC040	5.75	7.85	KAA040	6.00	9.05	7.90	27.4	KAX040	4.95	6.80	8.10	33.0	0.086	0.086	0.086	
	117.475	7.938	1	KBC040	8.10	10.5	KBA040	8.60	12.1	11.3	36.8	KBX040	7.05	9.00	11.6	43.1	0.136	0.136	0.136	
	120.65	9.525	1	KCC040	10.3	12.4	KCA040	11.2	14.9	14.7	45.1	KCX040	8.95	10.6	14.8	50.0	0.204	0.200	0.204	
	127	12.7	1.5	KDC040	15.7	17.2	KDA040	16.5	19.7	21.7	59.8	KDX040	13.6	14.8	22.6	67.4	0.354	0.363	0.354	
	139.7	19.05	2	KFC040	28.2	28.1	KFA040	30.3	32.9	39.8	99.6	KFX040	24.6	24.0	41.0	103	0.862	0.871	0.862	
	152.4	25.4	2	KGC040	42.6	39.6	KGA040	45.2	46.0	59.5	139	KGX040	37.3	34.5	62.4	141	1.63	1.64	1.63	
	107.95	120.65	6.35	0.6	KAC042	5.85	8.30	KAA042	6.15	9.55	8.10	29.0	KAX042	5.10	7.15	8.25	35.0	0.091	0.091	0.091
		123.825	7.938	1	KBC042	8.25	10.9	KBA042	8.75	12.7	11.5	38.6	KBX042	7.15	9.40	11.7	45.2	0.141	0.141	0.141
127		9.525	1	KCC042	10.5	13.0	KCA042	11.5	15.8	15.1	47.8	KCX042	9.15	11.2	15.0	53.0	0.213	0.209	0.213	
133.35		12.7	1.5	KDC042	15.8	17.8	KDA042	16.8	20.8	22.1	62.9	KDX042	13.7	15.3	22.8	70.2	0.376	0.381	0.376	
146.05		19.05	2	KFC042	28.8	29.4	KFA042	30.6	34.0	40.3	103	KFX042	25.1	25.2	41.8	109	0.907	0.925	0.907	
158.75		25.4	2	KGC042	42.2	39.9	KGA042	46.2	48.0	60.8	146	KGX042	36.9	34.3	61.8	142	1.72	1.74	1.72	
114.3		127	6.35	0.6	KAC045	6.00	8.75	KAA045	6.25	10.1	8.25	30.5	KAX045	5.20	7.55	8.40	37.0	0.100	0.095	0.100
		130.175	7.938	1	KBC045	8.45	11.6	KBA045	8.90	13.3	11.7	40.4	KBX045	7.35	10.0	12.0	48.3	0.150	0.154	0.150
	133.35	9.525	1	KCC045	10.7	13.7	KCA045	11.7	16.6	15.4	50.4	KCX045	9.30	11.8	15.3	56.1	0.218	0.222	0.218	
	139.7	12.7	1.5	KDC045	16.3	19.0	KDA045	17.2	21.8	22.6	66.0	KDX045	14.2	16.3	23.4	75.5	0.399	0.399	0.399	

K-series super thin section ball bearings
open type

d (114.3) ~ (165.1) mm

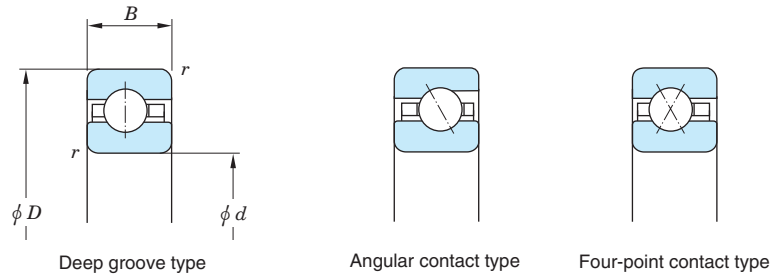

Boundary dimensions (mm)				Deep groove type			Angular contact type				Four-point contact type				(Refer.) Mass (kg)				
d	D	B	r min.	Bearing No.	Basic load ratings (kN)		Bearing No.	Basic load ratings (kN)			Bearing No.	Basic load ratings (kN)			Deep groove type	Angular contact type	Four-point contact type		
					C_r	C_{0r}		C_r	C_{0r}	C_a		C_{0a}	C_r	C_{0r}				C_a	C_{0a}
114.3	152.4	19.05	2	KFC045	29.4	30.8	KFA045	31.7	36.4	41.7	110	KFX045	25.6	26.3	42.6	115	0.953	0.971	0.953
	165.1	25.4	2	KGC045	43.6	42.7	KGA045	47.1	50.1	62.0	152	KGX045	38.1	36.4	63.6	152	1.81	1.79	1.81
120.65	133.35	6.35	0.6	KAC047	6.10	9.20	KAA047	6.40	10.6	8.40	32.1	KAX047	5.30	7.95	8.55	39.0	0.104	0.100	0.104
	136.525	7.938	1	KBC047	8.55	12.1	KBA047	9.10	14.2	12.0	42.9	KBX047	7.45	10.4	12.1	50.4	0.154	0.159	0.154
	139.7	9.525	1	KCC047	10.9	14.4	KCA047	12.0	17.5	15.7	53.0	KCX047	9.50	12.4	15.5	59.1	0.227	0.231	0.227
	146.05	12.7	1.5	KDC047	16.5	19.6	KDA047	17.5	22.8	23.0	69.1	KDX047	14.3	16.8	23.6	78.2	0.426	0.422	0.426
	158.75	19.05	2	KFC047	29.9	32.1	KFA047	32.0	37.5	42.2	114	KFX047	26.1	27.5	43.3	121	0.998	1.03	0.998
	171.45	25.4	2	KGC047	44.9	45.2	KGA047	48.0	52.1	63.1	158	KGX047	39.2	38.6	65.4	162	1.86	1.89	1.86
	127	139.7	6.35	0.6	KAC050	6.20	9.65	KAA050	6.50	11.1	8.55	33.6	KAX050	5.35	8.35	8.65	41.1	0.109	0.104
	142.875	7.938	1	KBC050	8.80	12.8	KBA050	9.25	14.8	12.2	44.7	KBX050	7.60	11.0	12.4	53.6	0.172	0.168	0.172
	146.05	9.525	1	KCC050	11.1	15.0	KCA050	12.2	18.4	16.0	55.7	KCX050	9.65	12.9	15.8	62.1	0.263	0.245	0.263
	152.4	12.7	1.5	KDC050	16.9	20.8	KDA050	17.8	23.8	23.4	72.2	KDX050	14.7	17.9	24.2	83.5	0.454	0.445	0.454
	165.1	19.05	2	KFC050	30.5	33.4	KFA050	32.4	38.6	42.6	117	KFX050	26.5	28.7	44.0	127	1.04	1.08	1.04
	177.8	25.4	2	KGC050	46.2	47.6	KGA050	48.8	54.2	64.3	164	KGX050	40.3	40.7	67.1	173	1.95	2.00	1.95
139.7	152.4	6.35	0.6	KAC055	6.40	10.5	KAA055	6.75	12.1	8.85	36.8	KAX055	5.55	9.10	8.90	45.1	0.113	0.113	0.113
	155.575	7.938	1	KBC055	9.10	13.9	KBA055	9.60	16.2	12.6	49.0	KBX055	7.85	12.0	12.7	58.8	0.186	0.181	0.186
	158.75	9.525	1	KCC055	11.5	16.4	KCA055	12.5	19.8	16.5	60.0	KCX055	10.0	14.1	16.2	68.2	0.268	0.263	0.268
	165.1	12.7	1.5	KDC055	17.5	22.6	KDA055	18.4	25.9	24.2	78.5	KDX055	15.2	19.4	24.9	91.6	0.481	0.481	0.481
	177.8	19.05	2	KFC055	31.5	36.1	KFA055	33.6	42.1	44.3	128	KFX055	27.4	31.0	45.3	140	1.13	1.17	1.13
	190.5	25.4	2	KGC055	47.0	49.8	KGA055	50.5	58.3	66.4	177	KGX055	41.0	42.6	68.0	184	2.13	2.15	2.13
	152.4	165.1	6.35	0.6	KAC060	6.60	11.4	KAA060	6.95	13.2	9.15	39.9	KAX060	5.75	9.85	9.15	49.1	0.127	0.127
	168.275	7.938	1	KBC060	9.35	15.1	KBA060	9.90	17.6	13.0	53.3	KBX060	8.10	13.0	13.1	64.1	0.200	0.200	0.200
	171.45	9.525	1	KCC060	11.9	17.7	KCA060	12.9	21.5	17.0	65.3	KCX060	10.3	15.3	16.7	74.2	0.286	0.290	0.286
	177.8	12.7	1.5	KDC060	18.0	24.4	KDA060	19.0	27.9	24.9	84.7	KDX060	15.7	21.0	25.5	99.7	0.526	0.522	0.526
	190.5	19.05	2	KFC060	32.5	38.8	KFA060	34.8	45.6	45.8	138	KFX060	28.2	33.3	46.5	152	1.22	1.23	1.22
	203.2	25.4	2	KGC060	49.3	54.7	KGA060	52.0	62.4	68.4	189	KGX060	42.9	46.8	71.1	205	2.31	2.30	2.31
165.1	177.8	6.35	0.6	KAC065	6.80	12.3	KAA065	7.15	14.2	9.40	43.0	KAX065	5.90	10.6	9.40	53.2	0.136	0.136	0.136
	180.975	7.938	1	KBC065	9.65	16.3	KBA065	10.1	18.8	13.3	56.9	KBX065	8.35	14.0	13.4	69.3	0.213	0.213	0.213

K-series super thin section ball bearings open type

d (165.1) ~ 228.6 mm

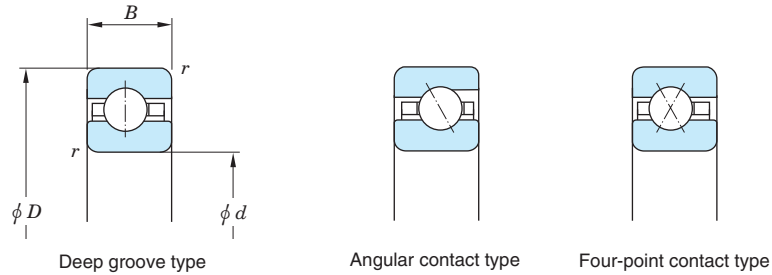

Boundary dimensions (mm)				Deep groove type		Angular contact type				Four-point contact type				(Refer.) Mass (kg)					
d	D	B	r min.	Bearing No.	Basic load ratings (kN)		Bearing No.	Basic load ratings (kN)			Bearing No.	Basic load ratings (kN)			Deep groove type	Angular contact type	Four-point contact type		
					C_r	C_{0r}		C_r	C_{0r}	C_a		C_{0a}	C_r	C_{0r}				C_a	C_{0a}
165.1	184.15	9.525	1	KCC065	12.2	19.0	KCA065	13.4	23.3	17.6	70.6	KCX065	10.6	16.4	17.1	80.3	0.308	0.308	0.308
	190.5	12.7	1.5	KDC065	18.6	26.1	KDA065	19.5	30.0	25.6	90.9	KDX065	16.1	22.5	26.2	108	0.553	0.562	0.553
	203.2	19.05	2	KFC065	33.4	41.5	KFA065	36.0	49.1	47.3	149	KFX065	29.0	35.6	47.7	164	1.32	1.33	1.32
	215.9	25.4	2	KGC065	50.0	57.0	KGA065	53.5	66.5	70.3	202	KGX065	43.5	48.8	71.8	216	2.45	2.45	2.45
177.8	190.5	6.35	0.6	KAC070	7.00	13.2	KAA070	7.35	15.2	9.65	46.1	KAX070	6.05	11.4	9.60	57.2	0.141	0.145	0.141
	193.675	7.938	1	KBC070	9.90	17.4	KBA070	10.4	20.2	13.7	61.2	KBX070	8.55	15.0	13.7	74.6	0.227	0.227	0.227
	196.85	9.525	1	KCC070	12.5	20.4	KCA070	13.6	24.7	17.9	74.9	KCX070	10.9	17.6	17.5	86.3	0.331	0.336	0.331
	203.2	12.7	1.5	KDC070	19.0	27.9	KDA070	20.0	32.1	26.3	97.2	KDX070	16.5	24.0	26.7	116	0.594	0.603	0.594
	215.9	19.05	2	KFC070	34.3	44.1	KFA070	37.0	52.6	48.7	159	KFX070	29.8	37.9	48.7	176	1.45	1.43	1.45
	228.6	25.4	2	KGC070	52.1	61.8	KGA070	54.8	70.7	72.2	214	KGX070	45.3	53.0	74.5	237	2.63	2.66	2.63
	190.5	203.2	6.35	0.6	KAC075	7.15	14.1	KAA075	7.50	16.2	9.90	49.2	KAX075	6.20	12.2	9.80	61.3	0.154	0.154
206.375		7.938	1	KBC075	10.1	18.6	KBA075	10.7	21.6	14.1	65.4	KBX075	8.80	16.0	14.0	79.8	0.240	0.245	0.240
209.55		9.525	1	KCC075	12.8	21.7	KCA075	14.0	26.5	18.4	80.2	KCX075	11.1	18.7	17.8	92.4	0.354	0.354	0.354
215.9		12.7	1.5	KDC075	19.5	29.7	KDA075	20.5	34.1	27.0	103	KDX075	16.9	25.6	27.3	124	0.640	0.644	0.640
228.6		19.05	2	KFC075	35.1	46.8	KFA075	37.5	54.8	49.3	166	KFX075	30.5	40.2	49.8	188	1.54	1.54	1.54
241.3		25.4	2	KGC075	52.6	64.1	KGA075	56.2	74.8	73.9	227	KGX075	45.8	55.0	75.2	249	2.77	2.81	2.77
203.2	215.9	6.35	0.6	KAC080	7.35	15.0	KAA080	7.70	17.3	10.1	52.3	KAX080	6.35	13.0	10.0	65.3	0.172	0.163	0.172
	219.075	7.938	1	KBC080	10.4	19.7	KBA080	11.0	23.0	14.4	69.7	KBX080	9.00	17.0	14.3	85.1	0.259	0.259	0.259
	222.25	9.525	1	KCC080	13.1	23.1	KCA080	14.4	28.2	18.9	85.5	KCX080	11.4	19.9	18.2	98.5	0.381	0.381	0.381
	228.6	12.7	1.5	KDC080	20.0	31.5	KDA080	21.0	36.2	27.6	110	KDX080	17.3	27.1	27.9	132	0.694	0.689	0.694
	241.3	19.05	2	KFC080	35.9	49.5	KFA080	38.5	58.3	50.6	177	KFX080	31.2	42.5	50.7	200	1.59	1.64	1.59
	254	25.4	2	KGC080	54.5	69.0	KGA080	57.4	78.9	75.5	239	KGX080	47.4	59.2	77.6	270	2.95	2.97	2.95
228.6	241.3	6.35	0.6	KAC090	7.65	16.8	KAA090	8.00	19.3	10.5	58.6	KAX090	6.60	14.5	10.4	73.4	0.200	0.186	0.200
	244.475	7.938	1	KBC090	10.8	22.1	KBA090	11.4	25.6	15.0	77.6	KBX090	9.35	19.1	14.8	95.6	0.299	0.290	0.299
	247.65	9.525	1	KCC090	13.7	25.7	KCA090	14.9	31.4	19.6	95.1	KCX090	11.9	22.2	18.9	111	0.426	0.445	0.426
	254	12.7	1.5	KDC090	20.8	35.0	KDA090	21.8	40.3	28.7	122	KDX090	18.0	30.2	28.9	148	0.780	0.767	0.780
	266.7	19.05	2	KFC090	37.4	54.8	KFA090	40.3	65.3	53.1	198	KFX090	32.5	47.2	52.6	224	1.77	1.79	1.77
	279.4	25.4	2	KGC090	56.8	76.1	KGA090	59.8	87.1	78.7	264	KGX090	49.4	65.3	80.5	302	3.27	3.27	3.27

K-series super thin section ball bearings open type

d 254 ~ 406.4 mm

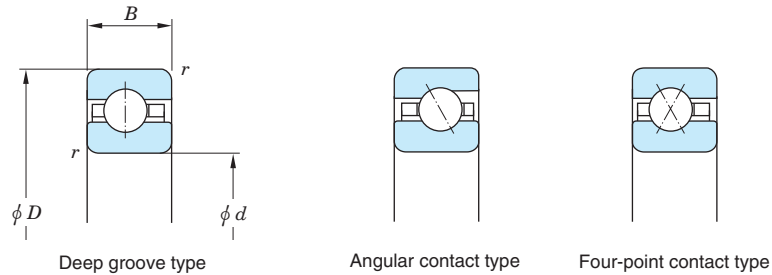

Boundary dimensions (mm)				Deep groove type			Angular contact type				Four-point contact type				(Refer.) Mass (kg)				
d	D	B	r min.	Bearing No.	Basic load ratings (kN)		Bearing No.	Basic load ratings (kN)			Bearing No.	Basic load ratings (kN)			Deep groove type	Angular contact type	Four-point contact type		
					C_r	C_{0r}		C_r	C_{0r}	C_a	C_{0a}		C_r	C_{0r}	C_a	C_{0a}			
254	266.7	6.35	0.6	KAC100	7.95	18.6	KAA100	8.30	21.4	11.0	64.8	KAX100	6.85	16.0	10.7	81.4	0.227	0.204	0.227
	269.875	7.938	1	KBC100	11.2	24.4	KBA100	11.9	28.4	15.6	86.1	KBX100	9.75	21.1	15.3	106	0.331	0.322	0.331
	273.05	9.525	1	KCC100	14.2	28.4	KCA100	15.6	34.9	20.5	106	KCX100	12.3	24.5	19.5	123	0.481	0.472	0.481
	279.4	12.7	1.5	KDC100	21.6	38.6	KDA100	22.7	44.4	29.8	135	KDX100	18.7	33.3	29.8	164	0.853	0.848	0.853
	292.1	19.05	2	KFC100	38.8	60.2	KFA100	41.6	71.1	54.7	215	KFX100	33.7	51.8	54.3	249	1.95	2.00	1.95
	304.8	25.4	2	KGC100	59.0	83.2	KGA100	62.0	95.3	81.6	289	KGX100	51.2	71.5	83.1	334	3.58	3.63	3.58
	279.4	292.1	6.35	0.6	KAC110	8.20	20.3	KAA110	8.60	23.4	11.3	71.0	KAX110	7.10	17.6	11.1	89.5	0.236	0.227
295.275		7.938	1	KBC110	11.6	26.7	KBA110	12.3	31.0	16.1	94.0	KBX110	10.1	23.1	15.7	117	0.340	0.354	0.340
298.45		9.525	1	KCC110	14.7	31.1	KCA110	16.1	38.0	21.1	115	KCX110	12.7	26.8	20.1	135	0.526	0.517	0.526
304.8		12.7	1.5	KDC110	22.3	42.2	KDA110	23.4	48.5	30.8	147	KDX110	19.3	36.4	30.7	180	0.934	0.930	0.934
317.5		19.05	2	KFC110	40.2	65.5	KFA110	43.2	78.0	56.9	236	KFX110	34.8	56.4	55.9	273	2.18	2.15	2.18
330.2		25.4	2	KGC110	61.0	90.3	KGA110	64.1	104	84.3	314	KGX110	52.9	77.7	85.5	366	3.90	3.94	3.90
304.8		317.5	6.35	0.6	KAC120	8.45	22.1	KAA120	8.90	25.5	11.7	77.3	KAX120	7.35	19.1	11.4	97.6	0.254	0.245
	320.675	7.938	1	KBC120	12.0	29.0	KBA120	12.7	33.8	16.7	103	KBX120	10.4	25.1	16.2	127	0.376	0.386	0.376
	323.85	9.525	1	KCC120	15.2	33.8	KCA120	16.5	41.2	21.8	125	KCX120	13.1	29.2	20.6	147	0.567	0.558	0.567
	330.2	12.7	1.5	KDC120	23.0	45.7	KDA120	24.2	52.6	31.8	160	KDX120	20.0	39.5	31.5	197	1.02	1.01	1.02
	342.9	19.05	2	KFC120	41.4	70.9	KFA120	44.3	83.8	58.3	254	KFX120	35.9	61.1	57.4	297	2.36	2.36	2.36
	355.6	25.4	2	KGC120	62.9	97.5	KGA120	66.0	112	86.9	339	KGX120	54.5	83.9	87.8	399	4.22	4.30	4.22
	355.6	371.475	7.938	1	KBC140	12.7	33.7	KBA140	13.4	39.1	17.6	118	KBX140	11.0	29.1	17.0	148	0.476	0.445
374.65		9.525	1	KCC140	16.0	39.1	KCA140	17.5	47.9	23.0	145	KCX140	13.9	33.8	21.6	171	0.689	0.649	0.689
381		12.7	1.5	KDC140	24.3	52.9	KDA140	25.5	60.9	33.6	184	KDX140	21.1	45.7	33.1	229	1.24	1.17	1.24
393.7		19.05	2	KFC140	43.7	81.5	KFA140	46.8	96.5	61.6	293	KFX140	37.9	70.3	60.2	345	2.72	2.61	2.72
406.4		25.4	2	KGC140	66.3	112	KGA140	69.7	128	91.7	389	KGX140	57.5	96.2	92.0	463	4.90	4.94	4.90
406.4		422.275	7.938	1	KBC160	13.3	38.3	KBA160	14.0	44.5	18.4	135	KBX160	11.5	33.1	17.7	169	0.544	0.508
	425.45	9.525	1	KCC160	16.8	44.4	KCA160	18.4	54.5	24.2	165	KCX160	14.6	38.4	22.6	195	0.785	0.739	0.785
	431.8	12.7	1.5	KDC160	25.5	60.0	KDA160	26.8	69.1	35.2	209	KDX160	22.1	51.8	34.5	261	1.41	1.33	1.41
	444.5	19.05	2	KFC160	45.8	92.2	KFA160	49.0	109	64.5	331	KFX160	39.7	79.6	62.7	394	3.22	3.08	3.22
	457.2	25.4	2	KGC160	69.5	126	KGA160	73.0	145	96.0	439	KGX160	60.3	109	95.9	528	5.58	5.62	5.58

K-series super thin section ball bearings open type

d 457.2 ~ 1 016 mm

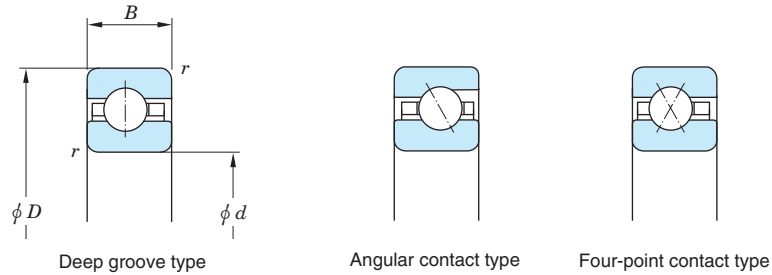

Boundary dimensions (mm)				Deep groove type			Angular contact type				Four-point contact type				(Refer.) Mass (kg)				
d	D	B	r min.	Bearing No.	Basic load ratings (kN)		Bearing No.	Basic load ratings (kN)			Bearing No.	Basic load ratings (kN)			Deep groove type	Angular contact type	Four-point contact type		
					C_r	C_{0r}		C_r	C_{0r}	C_a		C_{0a}	C_r	C_{0r}				C_a	C_{0a}
457.2	473.075	7.938	1	KBC180	13.9	42.9	KBA180	14.6	49.9	19.2	151	KBX180	12.0	37.1	18.4	190	0.612	0.572	0.612
	476.25	9.525	1	KCC180	17.5	49.8	KCA180	19.2	61.2	25.3	185	KCX180	15.2	43.0	23.4	220	0.880	0.830	0.880
	482.6	12.7	1.5	KDC180	26.6	67.1	KDA180	27.6	77.3	36.3	234	KDX180	23.0	58.0	35.8	293	1.58	1.49	1.58
	495.3	19.05	2	KFC180	47.8	103	KFA180	51.5	123	67.7	373	KFX180	41.4	88.8	65.0	442	3.58	3.48	3.58
	508	25.4	2	KGC180	72.5	140	KGA180	76.0	161	100	488	KGX180	62.8	121	99.4	592	6.21	6.26	6.21
508	523.875	7.938	1	KBC200	14.4	47.6	KBA200	15.2	55.3	20.0	168	KBX200	12.5	41.2	19.0	211	0.680	0.635	0.680
	527.05	9.525	1	KCC200	18.2	55.1	KCA200	19.9	67.5	26.2	205	KCX200	15.8	47.7	24.2	244	0.980	0.921	0.980
	533.4	12.7	1.5	KDC200	27.6	74.3	KDA200	29.0	85.6	38.1	259	KDX200	23.9	64.2	37.0	326	1.75	1.66	1.75
	546.1	19.05	2	KFC200	49.6	114	KFA200	53.4	136	70.3	412	KFX200	43.0	98.1	67.2	491	4.04	3.84	4.04
	558.8	25.4	2	KGC200	75.2	154	KGA200	78.9	178	104	538	KGX200	65.2	133	103	657	8.53	6.89	8.53
635	654.05	9.525	1	KCC250	19.7	68.5	KCA250	21.6	84.0	28.4	255	KCX250	17.1	59.2	26.0	304	1.22	1.14	1.22
	660.4	12.7	1.5	KDC250	29.9	92.1	KDA250	31.4	106	41.3	322	KDX250	25.9	79.6	39.7	407	2.17	2.06	2.17
	673.1	19.05	2	KFC250	53.7	140	KFA250	57.6	167	75.8	506	KFX250	46.5	121	72.0	612	4.94	4.76	4.94
	685.8	25.4	2	KGC250	81.4	190	KGA250	85.4	219	112	663	KGX250	70.5	164	110	819	8.85	8.53	8.85
762	781.05	9.525	1	KCC300	21.1	81.9	KCA300	23.1	101	30.3	305	KCX300	18.3	70.8	27.6	365	1.46	1.37	1.46
	787.4	12.7	1.5	KDC300	32.0	110	KDA300	33.5	127	44.1	384	KDX300	27.7	95.0	42.1	487	2.60	2.47	2.60
	800.1	19.05	2	KFC300	57.3	167	KFA300	61.6	200	81.0	605	KFX300	49.6	144	76.3	733	5.90	5.67	5.90
	812.8	25.4	2	KGC300	86.8	226	KGA300	91.1	260	120	788	KGX300	75.2	195	116	980	10.6	10.2	10.6
889	927.1	19.05	2	KFC350	60.6	194	KFA350	65.2	232	85.8	703	KFX350	52.5	168	80.1	854	6.85	6.62	6.85
	939.8	25.4	2	KGC350	91.7	261	KGA350	96.2	301	127	912	KGX350	79.4	226	122	1 140	12.3	11.9	12.3
1 016	1 054.1	19.05	2	KFC400	63.5	221	KFA400	68.4	264	90.0	801	KFX400	55.0	191	83.6	975	7.80	7.53	7.80
	1 066.8	25.4	2	KGC400	96.2	297	KGA400	101	342	133	1 040	KGX400	83.3	257	128	1 300	14.0	13.5	14.0

K-series super thin section ball bearings
sealed type

d 101.6 ~ 304.8 mm

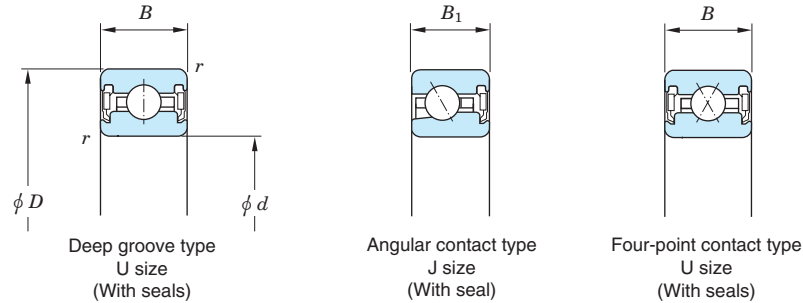

Boundary dimensions (mm)					Deep groove type Basic load ratings		Angular contact type Basic load ratings				Four-point contact type Basic load ratings				(Refer.) Mass (kg)					
<i>d</i>	<i>D</i>	<i>B</i>	<i>B</i> ₁	<i>r</i> min.	Bearing No.	<i>C</i> _r (kN)	<i>C</i> _{0r} (kN)	Bearing No.	<i>C</i> _r (kN)	<i>C</i> _{0r} (kN)	<i>C</i> _a (kN)	<i>C</i> _{0a} (kN)	Bearing No.	<i>C</i> _r (kN)	<i>C</i> _{0r} (kN)	<i>C</i> _a (kN)	<i>C</i> _{0a} (kN)	Deep groove type	Angular contact type	Four-point contact type
101.6	120.65	12.7	11.1	0.4	KUC040 2RD	10.3	12.4	KJA040 RD	11.2	14.9	14.7	45.1	KUX040 2RD	8.95	10.6	14.8	50.0	0.249	0.222	0.249
107.95	127	12.7	11.1	0.4	KUC042 2RD	10.5	13.0	KJA042 RD	11.5	15.8	15.1	47.8	KUX042 2RD	9.15	11.2	15.0	53.0	0.263	0.236	0.263
114.3	133.35	12.7	11.1	0.4	KUC045 2RD	10.7	13.7	KJA045 RD	11.7	16.6	15.4	50.4	KUX045 2RD	9.30	11.8	15.3	56.1	0.277	0.254	0.277
120.65	139.7	12.7	11.1	0.4	KUC047 2RD	10.9	14.4	KJA047 RD	12.0	17.5	15.7	53.0	KUX047 2RD	9.50	12.4	15.5	59.1	0.295	0.268	0.295
127	146.05	12.7	11.1	0.4	KUC050 2RD	11.1	15.0	KJA050 RD	12.2	18.4	16.0	55.7	KUX050 2RD	9.65	12.9	15.8	62.1	0.308	0.281	0.308
139.7	158.75	12.7	11.1	0.4	KUC055 2RD	11.5	16.4	KJA055 RD	12.5	19.8	16.5	60.0	KUX055 2RD	10.0	14.1	16.2	68.2	0.336	0.304	0.336
152.4	171.45	12.7	11.1	0.4	KUC060 2RD	11.9	17.7	KJA060 RD	12.9	21.5	17.0	65.3	KUX060 2RD	10.3	15.3	16.7	74.2	0.367	0.331	0.367
165.1	184.15	12.7	11.1	0.4	KUC065 2RD	12.2	19.0	KJA065 RD	13.4	23.3	17.6	70.6	KUX065 2RD	10.6	16.4	17.1	80.3	0.395	0.354	0.395
177.8	196.85	12.7	11.1	0.4	KUC070 2RD	12.5	20.4	KJA070 RD	13.6	24.7	17.9	74.9	KUX070 2RD	10.9	17.6	17.5	86.3	0.422	0.381	0.422
190.5	209.55	12.7	11.1	0.4	KUC075 2RD	12.8	21.7	KJA075 RD	14.0	26.5	18.4	80.2	KUX075 2RD	11.1	18.7	17.8	92.4	0.449	0.404	0.449
203.2	222.25	12.7	11.1	0.4	KUC080 2RD	13.1	23.1	KJA080 RD	14.4	28.2	18.9	85.5	KUX080 2RD	11.4	19.9	18.2	98.5	0.481	0.431	0.481
228.6	247.65	12.7	11.1	0.4	KUC090 2RD	13.7	25.7	KJA090 RD	14.9	31.4	19.6	95.1	KUX090 2RD	11.9	22.2	18.9	111	0.535	0.499	0.535
254	273.05	12.7	11.1	0.4	KUC100 2RD	14.2	28.4	KJA100 RD	15.6	34.9	20.5	106	KUX100 2RD	12.3	24.5	19.5	123	0.594	0.531	0.594
279.4	298.45	12.7	11.1	0.4	KUC110 2RD	14.7	31.1	KJA110 RD	16.1	38.0	21.1	115	KUX110 2RD	12.7	26.8	20.1	135	0.649	0.581	0.649
304.8	323.85	12.7	11.1	0.4	KUC120 2RD	15.2	33.8	KJA120 RD	16.5	41.2	21.8	125	KUX120 2RD	13.1	29.2	20.6	147	0.708	0.630	0.708

Bearings for railway rolling stock axle journals

Bearings used to support rolling stock axle journals are required to be very strong and, at the same time, to be small because of limited space.

Double-row bearings that are larger in width than general bearings are popular in that they are compact and have high load ratings.

■ Cylindrical roller bearings

- Feature good high-speed performance, and can be maintained and inspected easily because of their separable structure.

Most commonly used bearing.

- Those with a rib next to the inner ring are able to support not only radial load but also a certain degree of axial load, so that a ball bearing is not required to accommodate the axial load.

■ Sealed type cylindrical roller bearing units and tapered roller bearing units

- Maintenance-free : pre-lubricated with grease and provided with oil seals.
- Can be used with a simplified axle box, or with an adapter instead.
- The inch series axle bearing units (ABU) are as specified in the "association of american rail-roads".

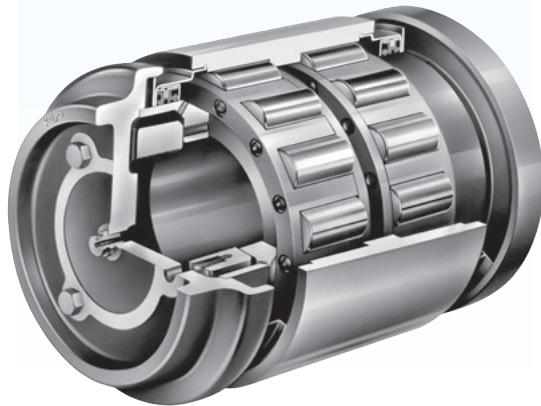

Cylindrical roller bearings

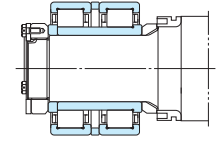

Bore diameter **85 – 133 mm**

Sealed type cylindrical roller bearing units

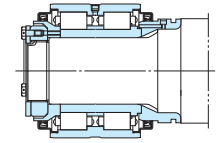

Bore diameter **95 – 120 mm**

Sealed type tapered roller bearing units(ABU)

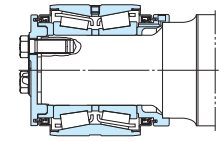

Bore diameter **101.600 – 177.787 mm**

Tolerances	<ul style="list-style-type: none"> Cylindrical roller and axial load support ball bearings : as specified in JIS B 1514-1, class 0 (Table 7-3 on pp. A 60–A 63). (The tolerances for cylindrical roller bearing width and overall width are as shown in Table 1.) Metric series ABU bearings: refer to Table 2. Inch series ABU bearings : refer to Table 3.
Recommended fits	Refer to Table 4.
Radial internal clearance	<ul style="list-style-type: none"> Cylindrical roller bearings : class C 3 UIC* standard cylindrical roller bearings : class C 4 (refer to Table 10-8 on p. A 106.) Axial load support ball bearings : class C 5 However, the clearance class should be adjusted according to the axle box structure. Consult with JTEKT for further information. ABU bearings : class C 3 (refer to Table 10-10 on p. A 110) *Denotes that the bearings are compatible with axle journals and axle boxes standardized by the UIC.

Table 1 Cylindrical roller bearings for axle journals : tolerances for inner ring width, outer ring width and overall width

(1) Tolerances for inner ring width and inner ring overall width Unit : μm

Bearing type	Design	Nominal bore diameter d (mm)		Δ_{B_s} or $\Delta_{B_{1s}}$	
		over	up to	upper	lower
Inner ring one-piece type, Inner ring with a rib and loose rib	1-1, 1-2 2-1, 2-3	80	120	0	- 400
		120	180	0	- 500
Two inner rings and spacer	2-2	80	120	0	- 600
		120	180	0	- 700

(2) Tolerances for outer ring width and outer ring overall width Unit : μm

Bearing type	Design	Nominal bore diameter d (mm)		Δ_{C_s} or $\Delta_{C_{1s}}$	
		over	up to	upper	lower
Outer ring one-piece type	2-3	80	120	0	- 300
		120	180	0	- 350
Outer ring and two loose ribs	1-1	80	120	+ 100	- 200
		120	180	+ 100	- 250
Two outer rings	2-1 ¹⁾	120	180	0	- 500
Two outer rings and spacer	1-2 2-1, 2-2	80	120	0	- 500
		120	180	0	- 600

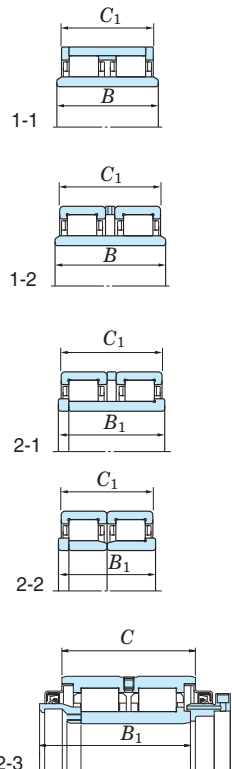

[Note] 1) (2-1) means that spacer shown in Design 2-1 is removed.

Table 2 Metric series ABU bearing tolerances Unit : μm

Nominal bore diameter d (mm)	Single plane mean bore diameter deviation $\Delta_{d_{mp}}$		Single plane mean outside diameter deviation $\Delta_{D_{mp}}$		Single outer ring width deviation Δ_{C_s}		Actual overall width of inner rings deviation $\Delta_{B_{1s}}$	
	upper	lower	upper	lower	upper	lower	upper	lower
110	0	- 20			+ 50	- 50		
120	0	- 20	0	- 125	+ 100	- 100	+ 500	- 500
130	0	- 25			+ 100	- 100		

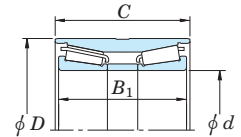

Table 3 Inch series ABU bearing tolerances Unit : μm

Nominal bore diameter d (mm)	Single plane mean bore diameter deviation $\Delta_{d_{mp}}$		Single plane mean outside diameter deviation $\Delta_{D_{mp}}$		Single outer ring width deviation Δ_{C_s}		Actual overall width of inner rings deviation $\Delta_{B_{1s}}$	
	upper	lower	upper	lower	upper	lower	upper	lower
101.6 to 177.8	+ 25	0	+ 127	0	+ 50	- 250	+ 710	- 510

Table 4 Axle journal bearing recommended fits

Bearing type	Axle journal diameter (mm)		Axle journal tolerance class	Axle box bore tolerance class
	over	up to		
Cylindrical roller bearing Tapered roller bearing	50	100	(m 6), n 6	H 7
	100	140	n 6	
	140	240	p 6	
Axial load support deep groove ball bearing	All diameters		k 5	Clearance fit (clearance of approx. 0.2 to 0.6 mm)

**Cylindrical roller bearings
for railway rolling stock axle journals**

d 85 ~ (120) mm

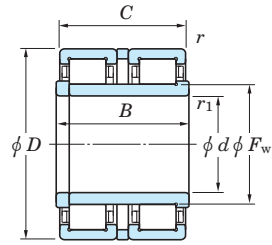

Design 1

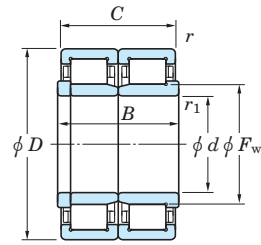

Design 2

d (120) ~ 133 mm

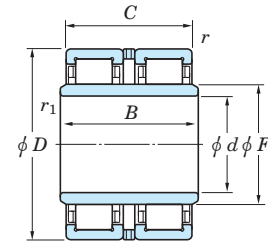

Design 3

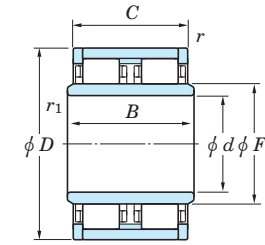

Design 4

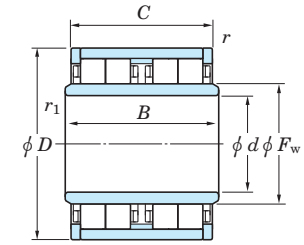

Design 5

<i>d</i>	Boundary dimensions (mm)						Basic load ratings (kN)		Bearing No. ²⁾	Design ³⁾	(Refer.) Mass (kg)
	<i>D</i>	<i>B</i>	<i>C</i>	<i>F_w</i>	<i>r</i> _{min.}	<i>r</i> ₁ ¹⁾ _{min.}	<i>C_r</i>	<i>C</i> _{0r}			
85	150	130	120	101.5	1.1	(7)	369	592	2U2217SC	3	8.6
90	160	88	80	107	2	2	355	529	2CR90D	1	7.2
95	170	120	105	114	1.1	(10)	497	804	2UJ95	4	10.9
	170	125	115	113.5	2.5	(7)	441	687	2CR95A	1	11.5
	170	130	130	114	2	2	441	688	2UJ1917	3	11.4
	170	140	125	114	1.1	(10)	555	926	4UJ95	5	12.7
100	180	150	134	120	1.1	(10)	594	990	4UJ100	5	15.1
	190	140	130	122	2.5	(7)	697	1 120	2ODC19130/140	3	16.9
	200	170	170	125	2	(7)	755	1 160	2CR100	1	23.7
	200	170	170	125	2	(10)	755	1 160	2ODC20170	3	23.2
110	200	180	160	134	1.1	(7)	721	1 190	JC3	5	22.6
	220	180	160	138	2.5	(7)	789	1 190	JC6	1	30.0
	220	185	180	138	2	(7)	922	1 460	2CR110	1	31.3
	225	150	140	138	1.1	(7)	833	1 230	JC1A	4	27.7
	225	150	140	138	2.5	(7)	897	1 350	22DC23140/150	3	26.7
	235	180	160	141	2.5	(7)	934	1 430	JC2A	3	35.3
116	220	185	180	142	2	(7)	891	1 470	2CR116	1	30.5
	225	150	140	197.5	1.1	(7)	786	1 220	2UJ116	4	26.0
120	225	170	165	145	3	(10)	876	1 380	JC35	1	29.4
	230	170	165	145	3	(10)	943	1 460	JC34	1	30.8
	230	177	150	145	3	(30)	943	1 460	JC27X	(1)	29.7
	240	160	160	150	3	7.5	961	1 500	(24NJ/NJP2480)	2	33.9
	240	180	160	150	1.1	(10)	1 020	1 580	JC11	4	35.5
	240	180	176	150	3	(7)	1 020	1 580	JC12	1	37.7

[Notes] 1) Values in () indicate axial chamfer dimension.
 2) Bearings indicated in () are in accordance with UIC standards.
 3) (1) means that the inner ring (rib side) shown in Design 1 has a special form.
 (2) means that loose rib shown in Design 2 is replaced with thrust collar.

<i>d</i>	Boundary dimensions (mm)						Basic load ratings (kN)		Bearing No. ²⁾	Design ³⁾	(Refer.) Mass (kg)
	<i>D</i>	<i>B</i>	<i>C</i>	<i>F_w</i>	<i>r</i> _{min.}	<i>r</i> ₁ ¹⁾ _{min.}	<i>C_r</i>	<i>C</i> _{0r}			
120	240	185	180	150	2	(7)	983	1 600	2CR120A	1	37.8
130	220	170	160	152	1.1	0.6	865	1 520	4UJ130B	5	25.2
	240	160	160	157	3	5	867	1 390	(2CR2624A)	2	32.0
	240	180	160	158	1.1	(10)	970	1 610	4UJ130A	5	35.8
	240	204	198	157	3	5	867	1 390	(2CR2624)	2	35.4
	250	160	160	158	3	7.5	1 090	1 720	(26NJ/NJP2580)	2	36.4
	260	180	160	163	1.1	(10)	1 080	1 710	JC5	4	42.7
	260	185	180	163	3	(7)	1 030	1 610	2CR130A	1	44.2
	260	186	172	164	3	7.5	1 220	1 930	26NJ/NUJ2686	(2)	44.6
	260	205.5	180	163	3	(30)	1 030	1 610	JC21	(1)	45.1
270	215	210	164	4	(15)	1 280	2 000	JC29	3	55.1	
280	215	210	167	4	(15)	1 440	2 250	JC9-1	3	61.4	
133	280	215	210	167	4	(15)	1 440	2 250	JC9-2	3	59.8

Sealed type cylindrical roller bearings for railway rolling stock axle journals

d 95 ~ 120 mm

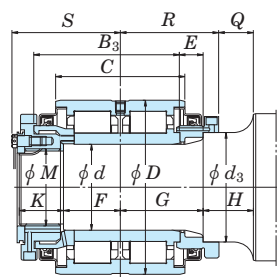

Design 1

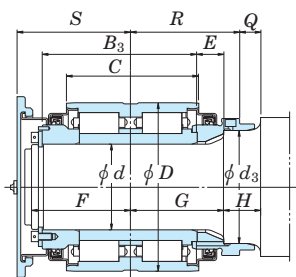

Design 2

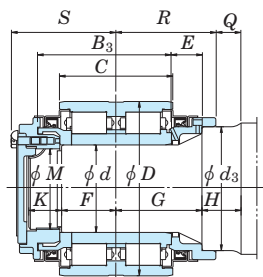

Design 3

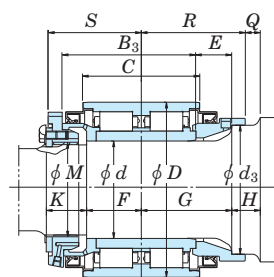

Design 4

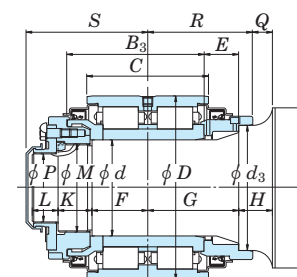

Design 5

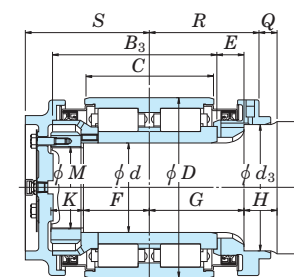

Design 6

Shaft dia. (mm)	Unit No.	Design	Boundary dimensions (mm)														Basic load ratings (kN)	(Refer.) Unit Mass (kg)				
			$d_{Brg.}$	D	C	B_3	d_3	E	F	G	H	K	L	M	P	Q			R	S	Bearing No.	C_r
95	JB1425	1	95	190	140	158	120	25	62	90	35	48	—	M85×4	—	18	107	119	19RDC19140/158	610	910	24.5
100	JB1199B	2	100	195	150	175	130	30	120	105	42	—	—	—	—	24	123	130	20RDC20150/133B	673	1 040	27.5
110	JB1462	3	110	220	145	171	155	39	70	110	50	42	—	M100×2	—	33	127	134	S-JC33	789	1 190	35.9
120	JB1356	4	120	220	150	170	158	46	70	116	36	51	—	M115×4	—	19	133	131	24RDC22150/170	702	1 110	34.9
	JB1380D	5	120	230	150	171	155	43	70	113	42	42	33	M110×2	85	25	130	152	JC32	831	1 290	39.0
	JB1010	6	120	240	170	218	168	35	87	125	45	43	—	M110×2	—	25	145	164	JC17	1 020	1 580	57.7
	JB1240	7	120	240	160	193	168	31	80	113	38	40	38	M110×2	85	27	128	169	JC26	935	1 420	51.1
	JB1377	8	120	240	160	192	150	30	83	112	40	38	—	M110×4	—	—	135	131	24RDC24160/192A	935	1 420	42.0

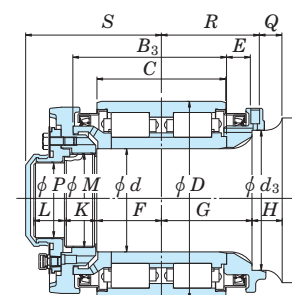

Design 7

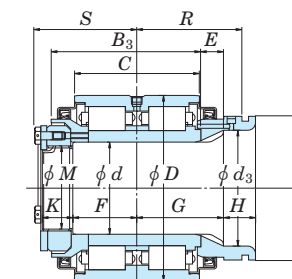

Design 8

Sealed type tapered roller bearings for railway rolling stock axle journals (ABU bearing)

d 101.6 ~ 177.787 mm
110 ~ 130 mm

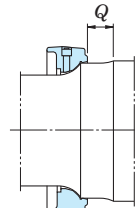
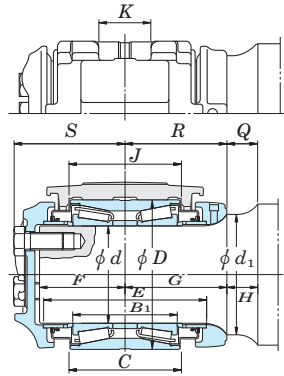
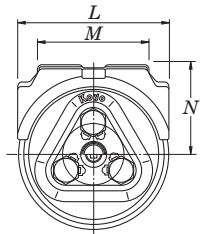

The shape of the backing ring used for JB1204P, JB1205P and JB1206P.

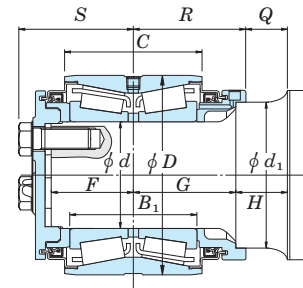

JB1486

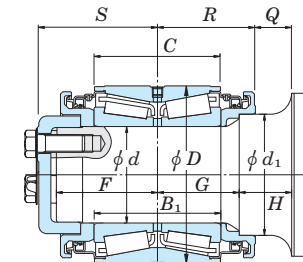

JB1450

Dynamic equivalent load
(when $F_a/F_r \leq e$)
 $P = F_r + Y_2 F_a$
(when $F_a/F_r > e$)
 $P = 0.67 F_r + Y_3 F_a$
Static equivalent load
 $P_0 = F_r + Y_0 F_a$

Class	Axle size	Unit No.	Boundary dimensions (mm)													Adapter No.	Dimensions of adapter (mm)					Bolt size	Dimensions (mm) p	Bearing No.	Basic load ratings (kN)		Constant e	Axial load factors			(Refer.) Mass (kg)	
			Brg. d Axle ¹⁾	D	B ₁	C	d ₁ ¹⁾	E	F	G	H	Q	R	S	J		K	L	M	N	C _r				C _{0r}	Y ₂		Y ₃	Y ₀	Unit	Adapter	
																																C _r
B	4 1/2x8	JB1201	101.600	101.702 101.676	165.100	106.362	114.300	127.0	182.6	101.6	117.5	41.3	41.3	117.5	134.8	JB701	117.5	68.3	165.9	124.6	101.6	3/4-10 UNC	61.9	HM120848/ HM120817XD	402	769	0.26	2.55	3.80	2.50	17.3	3.8
C	5 x9	JB1202	119.062	119.164 119.139	195.262	136.525	142.875	149.2	217.5	112.7	134.9	36.5	36.5	134.9	147.0	JB702	146.0	74.6	196.1	143.7	117.5	7/8-9 UNC	76.2	HM124646/ HM124618XD	626	1200	0.26	2.55	3.80	2.50	25.3	6.1
D	5 1/2x10	JB1203	131.750	131.864 131.839	207.962	146.050	152.400	161.9	227.0	115.9	139.7	44.5	44.5	139.7	150.5	JB703	155.6	74.6	208.8	156.4	123.8	7/8-9 UNC	88.9	HM127446/ HM127415XD	641	1270	0.26	2.55	3.80	2.50	28.3	7.4
E	6 x11	JB1204	144.450	144.564 144.539	220.662	155.575	163.512	177.8	241.3	127.0	150.8	46.0	46.0	150.8	164.1	JB704	166.7	96.8	221.5	181.8	136.5	1-8 UNC	98.4	HM129848/ HM129814XD	667	1380	0.26	2.55	3.80	2.50	34.3	10.8
		JB1204P	144.450	144.564 144.539	220.662	155.575	163.512	178.613 178.562	241.3	127.0	150.8	46.0	36.8	160.0	164.1	JB704	166.7	96.8	221.5	181.8	136.5	1-8 UNC	98.4	HM129848/ HM129814XD	667	1380	0.26	2.55	3.80	2.50	35.0	10.8
F	6 1/2x12	JB1205	157.150	157.264 157.239	252.412	177.800	184.150	190.5	273.0	134.9	163.5	46.0	46.0	163.5	176.6	JB705	187.3	96.8	253.2	194.5	152.4	1 1/8-7 UNC	108.0	HM133444/ HM133416XD	910	1890	0.26	2.55	3.80	2.50	51.6	16.3
		JB1205P	157.150	157.264 157.239	252.412	177.800	184.150	191.313 191.262	273.0	134.9	163.5	46.0	36.7	172.8	176.6	JB705	187.3	96.8	253.2	194.5	152.4	1 1/8-7 UNC	108.0	HM133444/ HM133416XD	910	1890	0.26	2.55	3.80	2.50	52.4	16.3
G	7 x12	JB1206P	177.787	177.902 177.876	276.225	180.975	185.738	203.251 203.200	269.9	130.2	150.8	58.7	46.0	163.5	180.1	JB706 ²⁾	189.7	181.0	—	279.4	168.3	1 1/4-7 UNC	117.5	HM136948/ HM136916XD	1080	2220	0.26	2.55	3.80	2.50	59.2	23

—	110	JB558	110	110.076 110.054	175	125	130	155	206	105	135	30	30	135	136.4	JB558	134	70	175	135	110	M22	75	JT9	481	972	0.26	2.55	3.80	2.50	22.0	5.6
—		JB1486	110	110.059 110.037	205	130	140	150.068 150.043	—	85	105	53	43	115	118.4	—	—	—	—	—	—	M22	75	JT13	743	1220	0.26	2.55	3.80	2.50	27.3	—
—	120	JB613	120	120.076 120.054	195	136	142	155	217	113	135	30	30	135	147.5	JB613	146	74.5	196	142.5	118	M22	75	JT10	626	1200	0.26	2.55	3.80	2.50	27.0	6.2
—		JB1450	120	120.059 120.037	220	155	155	150.068 150.043	—	125	100	55	35	120	164.4	—	—	—	—	—	—	M22	75	JT12	907	1670	0.26	2.55	3.80	2.50	36.6	—
—	130	JB633	130	130.076 130.054	208	146	152	165	227	139	139	26	26	139	149.2	JB633 ²⁾	156	110	255	232	130	M22	89	JT11	641	1270	0.26	2.55	3.80	2.50	30.0	14.3



[Notes] 1) Upper figures : max. value ; lower : min.value

2) JB706 and JB633 indicate the specifications of wide adapters. Others indicate narrow adapters (shown in figures above).

Linear ball bearings

Linear ball bearings have an outer cylinder and a cage with three or more elliptic raceways inside. Balls are aligned on these raceways.

	Ball complement	bore diameter (mm)
SDM series	6 – 120
SDMF, SDMK series	6 – 80
SDE series	5 – 80

Standard type	Clearance adjustable type	Open type
		
Suitable for a wide range of applications and widely used in practice. The upper-class type is used for general purposes. The precision-class type is used when the bearing is required to be highly accurate.	The outer cylinder and side plate are slit axially so that the clearance between the bearing and shaft can be adjusted. Together with the use of a boreadjustable housing, a no-clearance state or light-preloaded state can be realized without fitting.	The outer cylinder and side plate each have a slit which is equivalent in size to a recirculating ball row raceway, so that the bearing does not interfere with a shaft strut during operation. This type is suitable for use with very long shafts. The bore diameter is adjustable.

Flanged type



Can be fit quickly, and helps make equipment smaller and lighter in weight. Helps reduce cost.

Sealed type

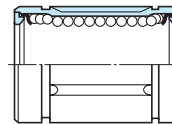

One or both side(s) is/are sealed with special synthetic rubber so that foreign material cannot enter the bearing while the grease is kept from leaking. This sealing can be provided on all bearings of the standard, clearance adjustable, open, and flanged types.



Bearing numbering system

Series code	Ball complement bore diameter number	Seal code	Shape code	Material code	Tolerance code
SDM	35	UU	AJ		
Series code	SDM : metric series SDMF : metric series (flanged type) SDMK : metric series (flanged type) SDE : metric series (popular ones in europe) SDB : inch series				
Ball complement bore diameter number	Metric series	35 : ball complement bore diameter 35 mm			
	Inch series	4 : ball complement bore diameter 4/16 = 1/4 inch			
Seal code	UU : both sides sealed U : single side sealed Not specified : not sealed				
Shape code	Not specified : standard type AJ : clearance adjustable type OP : open type				
Material code	Outer cylinder and balls	Not specified : high carbon chrome bearing steel			
	Cage	Not specified : cold rolled steel sheet MG : synthetic resin			
Tolerance code	Not specified : upper-class P : precision-class				

■ Linear ball bearing service life

Linear ball bearing service life refers to the distance that the bearing travels until the outer cylinder, balls or shaft become damaged because of rolling contact fatigue from repeated stress.

The basic dynamic load rating refers to the magnitude of a constant load which makes a bearing's service life end after it travels a distance of 50 km.

The linear ball bearing service life and the basic dynamic load rating bear the relation shown below :

$$L = 50 \left(\frac{C}{P} \right)^3$$

where :

- L : service life km
- P : radial load on the bearing N
- C : bearing basic dynamic load rating N (refer to the specification table.)

Shaft surface hardness is closely related to running performance. In general, it is best for the hardness to be 60 thru 64 HRC.

If the hardness is 60 HRC or lower, the basic dynamic load rating (C) should be corrected by multiplying it by the appropriate hardness coefficient selected from Table 1.

Shaft hardness HRC	Hardness coefficient f_H
60	1
59	0.97
57	0.88
55	0.76
53	0.64
51	0.52

● Ball row arrangement and load rating

The basic load ratings given in the specification table are those measured when a load is applied directly above a ball row (Q_1). When the load is applied between two ball rows, the load ratings become larger (Q_2). Table 2 lists the ratios of Q_2 ratings to Q_1 ratings.

Number of ball rows	When a load is applied directly above a row (Q_1)	When a load is applied between two rows (Q_2)	Ratios of Q_2 to Q_1
4			1.414
5			1.463
6			1.280

[Note] When there are only three rows, $Q_2 / Q_1 = 1$

■ Recommended fits for linear ball bearings

Table 3 lists the recommended fits for linear ball bearings.

When a bearing is mounted with a housing, the normal clearance fit should be selected. When the application is highly precise or special, the transition fit should be selected.

For the clearance adjustable and open type bearings, it is best for the shaft diameter to be smaller than the ball complement bore diameter lower deviation, and for the housing bore diameter to be larger than the bearing outside diameter upper deviation.

Table 3 Linear ball bearing recommended fits

Bearing	Tolerance	Shaft tolerance class		Housing bore tolerance class	
		Normal clearance	Close clearance	Clearance fit	Transition fit
SDM, SDB	Upper-class	f 6, g 6	h 6	H 7	JS 7 (J 7)
	Precision-class	f 5, g 5	h 5	H 6	JS 6 (J 6)
SDE	-	h 6	js 6 (j 6)	H 7	JS 7 (J 7)

■ Linear ball bearing clearance

Linear ball bearings provide linear motion smoothly with little wear when the clearance is 0.003 to 0.012 mm. However, when clearance increase due to wear is considered critical, e.g. when the bearing is provided to press die sets, precision machine tools or precision testers; when the bearing becomes unable to slide because of moment; or when smooth bearing operation is needed with no clearance provided, the clearance is adjusted to zero or negative.

In such a case, shafts generally need to be mounted by "selective fitting."

They should be handled carefully so as not to be preloaded excessively.

As Fig. 1 shows, the clearance of bearings with numbers SDM 6 thru SDM 10 can be easily set to

zero or negative, by adjusting one of the three ball rows with a bolt.

Consult with JTEKT on the gauging of linear ball bearings and shafts which should be mounted by "selective fitting," as well as on the whole design of shafts.

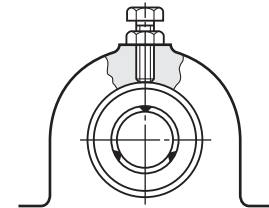

Fig. 1 Clearance adjustment

Table 4 SDM series linear ball bearing tolerances

Unit : μm

Bearing number SDM	Ball complement bore diameter (F_w) deviation				Outside diameter (D) deviation		Overall length (L) deviation		B deviation		Eccentricity	
	Precision-class		Upper-class								Precision-class	Upper-class
	upper	lower	upper	lower	upper	lower	upper	lower	max.			
6, 8	0	-6	0	-9	0	-11	0	-200	0	-200	8	12
10, 12, 13, 16	0	-6	0	-9	0	-13	0	-200	0	-200	8	12
20	0	-7	0	-10	0	-16	0	-200	0	-200	10	15
25, 30	0	-7	0	-10	0	-16	0	-300	0	-300	10	15
35, 38, 40, 50	0	-8	0	-12	0	-19	0	-300	0	-300	12	20
60	0	-9	0	-15	0	-22	0	-300	0	-300	17	25
80	0	-9	0	-15	0	-22	0	-400	0	-400	17	25
100, 120	0	-10	0	-20	0	-25	0	-400	0	-400	20	30

Table 5 SDE series linear ball bearing tolerances

Unit : μm

Bearing number SDE	Ball complement bore diameter (F_w) deviation		Outside diameter (D) deviation		Overall length (L) deviation		B deviation		Eccentricity max.
	upper	lower	upper	lower	upper	lower	upper	lower	
5, 8	+8	0	0	-8	0	-200	0	-200	12
10, 12	+8	0	0	-9	0	-200	0	-200	12
16	+9	-1	0	-9	0	-200	0	-200	12
20	+9	-1	0	-11	0	-200	0	-200	15
25, 30	+11	-1	0	-11	0	-300	0	-300	15
40, 50	+13	-2	0	-13	0	-300	0	-300	17
60	+13	-2	0	-15	0	-400	0	-400	20
80	+16	-4	0	-15	0	-400	0	-400	20

Linear ball bearings

d 5 ~ (20) mm

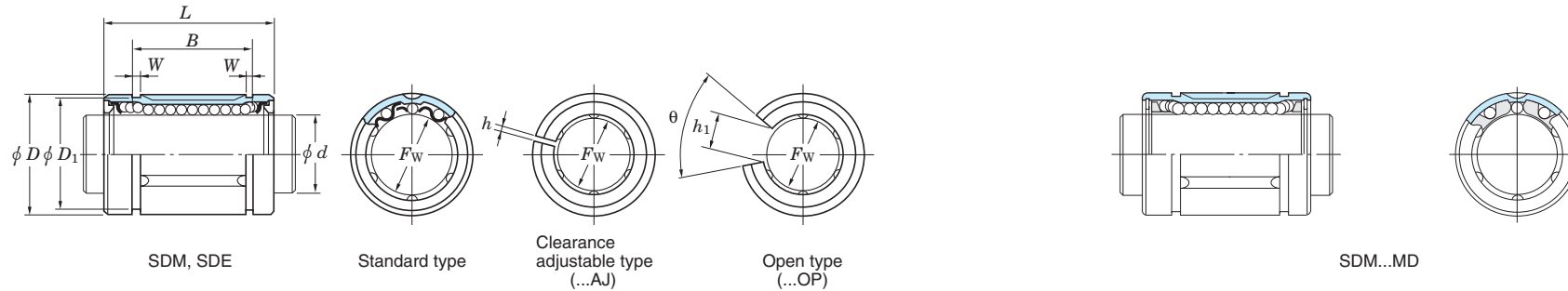

Shaft dia. (mm)	Dimensions (mm)									Bearing No. ¹⁾			No. of ball rows			Basic load ratings (N)		(Refer.) Mass (g)
	d	F _w	D	L	B	W	D ₁	h	h ₁	θ	Standard type	Clearance adjustable type	Open type	Standard type	Clearance adjustable type	Open type	C _r	C _{0r}
5	5	12	22	14.5	1.1	11.5	—	—	—	SDE5	—	—	3	—	—	108	183	10
6	6	12	19	13.5	1.1	11.5	1	—	—	SDM6	SDM6AJ	—	3	3	—	108	186	7
	6	12	19	13.5	1.1	11.5	1	—	—	SDM6MG	SDM6AJMG	—	4	4	—	108	186	6
8	8	15	17	11.5	1.1	14.3	1	—	—	SDM8S	SDM8SAJ	—	3	3	—	96	160	10
	8	15	17	11.5	1.1	14.3	1	—	—	SDM8SMG	SDM8SAJMG	—	4	4	—	96	160	9
	8	15	24	17.5	1.1	14.3	1	—	—	SDM8	SDM8AJ	—	3	3	—	122	223	14
	8	15	24	17.5	1.1	14.3	1	—	—	SDM8MG	SDM8AJMG	—	4	4	—	134	255	13
	8	16	25	16.5	1.1	15.2	1	—	—	SDE8	SDE8AJ	—	3	3	—	122	223	20
	8	16	25	16.5	1.1	15.2	1	—	—	SDE8MG	SDE8AJMG	—	4	4	—	134	255	18
10	10	19	29	22	1.3	18	1	6.8	80°	SDM10	SDM10AJ	SDM10OP	4	4	3	259	424	27
	10	19	29	22	1.3	18	1	—	—	SDM10MG	SDM8AJMG	—	4	4	—	259	424	23
	10	19	29	22	1.3	18	1	6.8	80°	SDE10	SDE10AJ	SDE10OP	4	4	3	259	424	27
	10	19	29	22	1.3	18	1	—	—	SDE10MG	SDE10AJMG	—	4	4	—	259	424	23
12	12	21	30	23	1.3	20	1.5	8	80°	SDM12	SDM12AJ	SDM12OP	4	4	3	260	431	31
	12	21	30	23	1.3	20	1.5	—	—	SDM12MG	SDM12AJMG	—	4	4	—	260	431	27
	12	22	32	22.9	1.3	21	1.5	7.5	78°	SDE12	SDE12AJ	SDE12OP	4	4	3	289	503	42
	12	22	32	22.9	1.3	21	1.5	—	—	SDE12MG	SDM12AJMG	—	4	4	—	289	503	37
13	13	23	32	23	1.3	22	1.5	9	80°	SDM13	SDM13AJ	SDM13OP	4	4	3	289	506	41
	13	23	32	23	1.3	22	1.5	—	—	SDM13MG	SDM13AJMG	—	4	4	—	289	506	35
16	16	26	36	24.9	1.3	24.9	1.5	10	78°	SDE16	SDE16AJ	SDE16OP	4	4	3	319	587	53
	16	26	36	24.9	1.3	24.9	1.5	—	—	SDE16MG	SDE16AJMG	—	4	4	—	319	587	47
	16	28	37	26.5	1.6	27	1.5	11	80°	SDM16	SDM16AJ	SDM16OP	4	4	3	480	766	69
	16	28	37	26.5	1.6	27	1.5	—	—	SDM16MG	SDM16AJMG	—	4	4	—	480	766	59
20	20	32	42	30.5	1.6	30.5	1.5	11	60°	SDM20	SDM20AJ	SDM20OP	5	5	4	590	1 010	92
	20	32	42	30.5	1.6	30.5	1.5	—	—	SDM20MG	SDM20AJMG	—	5	5	—	590	1 010	79

[Note] 1) JTEKT also manufactures sealed types, which are identified by U (one side sealed) or UU (both sides sealed) after ball complement bore diameter number.

Linear ball bearings

d (20) ~ 80 mm

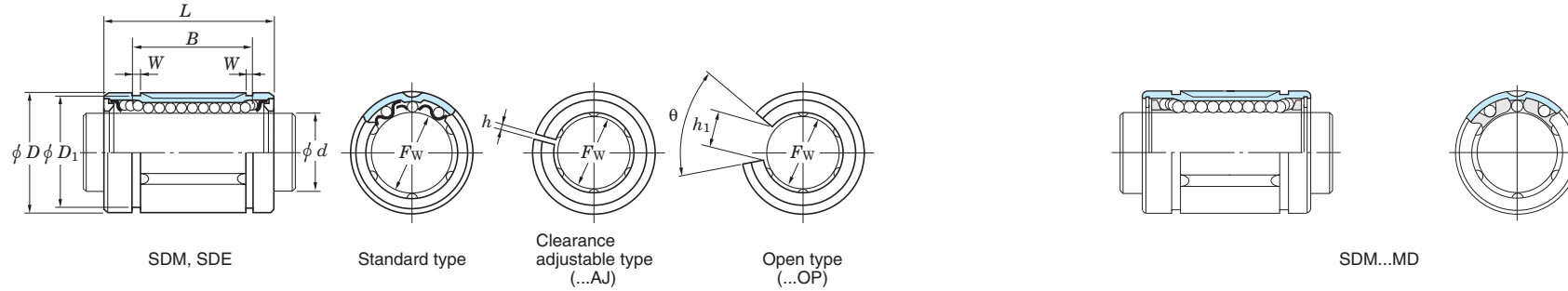

Shaft dia. (mm)	Dimensions (mm)									Bearing No. ¹⁾			No. of ball rows			Basic load ratings (N)		(Refer.) Mass (g)
	d	F _w	D	L	B	W	D ₁	h	h ₁	θ	Standard type	Clearance adjustable type	Open type	Standard type	Clearance adjustable type	Open type	C _r	C _{0r}
20	20	32	45	31.5	1.6	30.3	2	10	60°	SDE20	SDE20AJ	SDE20OP	5	5	4	590	1 010	96
	20	32	45	31.5	1.6	30.3	2	—	—	SDE20MG	SDE20AJMG	—	5	5	—	590	1 010	88
25	25	40	58	44.1	1.85	37.5	2	12.5	60°	SDE25	SDE25AJ	SDE25OP	5	5	4	1 130	2 030	190
	25	40	58	44.1	1.85	37.5	2	—	—	SDE25MG	SDE25AJMG	—	5	5	—	1 130	2 030	170
	25	40	59	41	1.85	38	2	12	60°	SDM25	SDM25AJ	SDM25OP	5	5	4	1 130	2 030	200
	25	40	59	41	1.85	38	2	—	—	SDM25MG	SDM25AJMG	—	5	5	—	1 130	2 030	170
30	30	45	64	44.5	1.85	43	2.5	15	50°	SDM30	SDM30AJ	SDM30OP	6	6	5	1 470	2 770	250
	30	45	64	44.5	1.85	43	2.5	—	—	SDM30MG	SDM30AJMG	—	6	6	—	1 470	2 770	220
	30	47	68	52.1	1.85	44.5	2	12.5	50°	SDE30	SDE30AJ	SDE30OP	6	6	5	1 470	2 770	340
	30	47	68	52.1	1.85	44.5	2	—	—	SDE30MG	SDE30AJMG	—	6	6	—	1 470	2 770	320
35	35	52	70	49.5	2.1	49	2.5	17	50°	SDM35	SDM35AJ	SDM35OP	6	6	5	1 580	3 070	370
	35	52	70	49.5	2.1	49	2.5	—	—	SDM35MG	SDM35AJMG	—	6	6	—	1 580	3 070	330
38	38	57	76	58.5	2.1	54.5	3	18	50°	SDM38	SDM38AJ	SDM38OP	6	6	5	2 020	3 600	490
40	40	60	80	60.5	2.1	57	3	20	50°	SDM40	SDM40AJ	SDM40OP	6	6	5	2 180	4 010	590
	40	60	80	60.5	2.1	57	3	—	—	SDM40MG	SDM40AJMG	—	6	6	—	2 180	4 010	530
	40	62	80	60.6	2.15	59	3	16.8	50°	SDE40	SDE40AJ	SDE40OP	6	6	5	2 180	4 010	710
	40	62	80	60.6	2.15	59	3	—	—	SDE40MG	SDE40AJMG	—	6	6	—	2 180	4 010	650
50	50	75	100	77.6	2.65	72	3	21	50°	SDE50	SDE50AJ	SDE50OP	6	6	5	4 020	7 110	1 050
	50	80	100	74	2.6	76.5	3	25	50°	SDM50	SDM50AJ	SDM50OP	6	6	5	4 420	7 150	1 500
60	60	90	110	85	3.15	86.5	3	30	50°	SDM60	SDM60AJ	SDM60OP	6	6	5	5 170	9 030	1 850
	60	90	125	101.7	3.15	86.5	3	27.2	54°	SDE60	SDE60AJ	SDE60OP	6	6	5	6 470	11 100	1 900
80	80	120	140	105.5	4.15	116	3	40	50°	SDM80	SDM80AJ	SDM80OP	6	6	5	8 180	12 800	4 200
	80	120	165	133.7	4.15	116	3	36.3	54°	SDE80	SDE80AJ	SDE80OP	6	6	5	8 890	14 500	4 800

[Note] 1) JTEKT also manufactures sealed types, which are identified by U (one side sealed) or UU (both sides sealed) after ball complement bore diameter number.

Linear ball bearings

d 100 ~ 120 mm

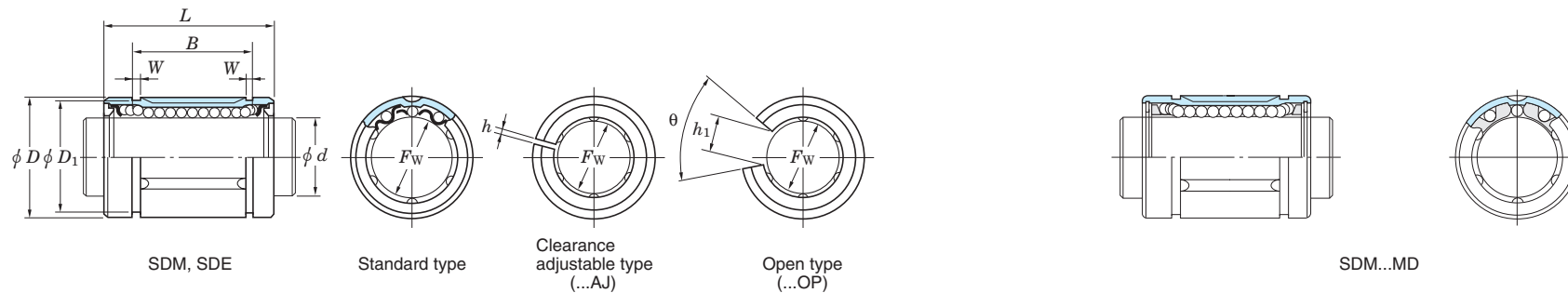

Shaft dia. (mm)	Dimensions (mm)									Bearing No. ¹⁾			No. of ball rows			Basic load ratings (N)		(Refer.) Mass (g)
	d	F_w	D	L	B	W	D_1	h	h_1	θ	Standard type	Clearance adjustable type	Open type	Standard type	Clearance adjustable type	Open type	C_r	C_{0r}
100	100	150	175	125.5	4.15	145	3	50	50°	SDM100	SDM100AJ	SDM100OP	6	6	5	12 300	19 700	8 200
120	120	180	200	158.6	4.15	175	4	85	80°	SDM120	SDM120AJ	SDM120OP	8	8	6	22 300	39 100	15 500

[Note] 1) JTEKT also manufactures sealed types, which are identified by U (one side sealed) or UU (both sides sealed) after ball complement bore diameter number.

Linear ball bearings
flanged type

d 6 ~ 50 mm

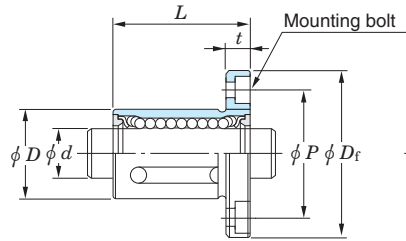

SDMF, SDMK

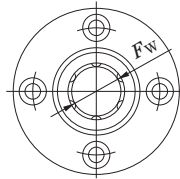

Round-flanged

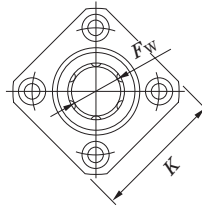

Square-flanged

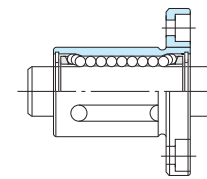

SDMF...MG
SDMK...MG (Synthetic resin)

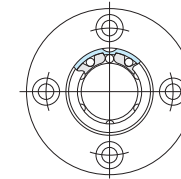

Round-flanged

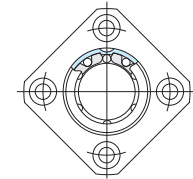

Square-flanged

Shaft dia. (mm) d	Dimensions (mm)							Bolt size	Bearing No.		No. of ball rows	Basic load ratings (N)		(Refer.) Mass (g) Round-flanged type
	F_w	D	L	D_f	K	t	P		Round-flanged type	Square-flanged type		C_r	C_{0r}	
6	6	12	19	28	22	5	20	M3	SDMF6	SDMK6	3	108	186	23
	6	12	19	28	22	5	20	M3	SDMF6MG	SDMK6MG		4	108	
8	8	15	24	32	25	5	24	M3	SDMF8	SDMK8	3	122	223	35
	8	15	24	32	25	5	24	M3	SDMF8MG	SDMK8MG		4	134	
10	10	19	29	40	30	6	29	M4	SDMF10	SDMK10	4	259	424	65
	10	19	29	40	30	6	29	M4	SDMF10MG	SDMK10MG		4	259	
12	12	21	30	42	32	6	32	M4	SDMF12	SDMK12	4	260	431	72
	12	21	30	42	32	6	32	M4	SDMF12MG	SDMK12MG		4	260	
13	13	23	32	43	34	6	33	M4	SDMF13	SDMK13	4	289	506	83
	13	23	32	43	34	6	33	M4	SDMF13MG	SDMK13MG		4	289	
16	16	28	37	48	37	6	38	M4	SDMF16	SDMK16	4	480	766	120
	16	28	37	48	37	6	38	M4	SDMF16MG	SDMK16MG		4	480	
20	20	32	42	54	42	8	43	M5	SDMF20	SDMK20	5	590	1 010	170
	20	32	42	54	42	8	43	M5	SDMF20MG	SDMK20MG		5	590	
25	25	40	59	62	50	8	51	M5	SDMF25	SDMK25	5	1 130	2 030	290
	25	40	59	62	50	8	51	M5	SDMF25MG	SDMK25MG		5	1 130	
30	30	45	64	74	58	10	60	M6	SDMF30	SDMK30	6	1 470	2 770	440
	30	45	64	74	58	10	60	M6	SDMF30MG	SDMK30MG		6	1 470	
35	35	52	70	82	64	10	67	M6	SDMF35	SDMK35	6	1 580	3 070	610
	35	52	70	82	64	10	67	M6	SDMF35MG	SDMK35MG		6	1 580	
40	40	60	80	96	75	13	78	M8	SDMF40	SDMK40	6	2 180	4 010	1 000
	40	60	80	96	75	13	78	M8	SDMF40MG	SDMK40MG		6	2 180	
50	50	80	100	116	92	13	98	M8	SDMF50	SDMK50	6	4 420	7 150	2 000

Linear ball bearings
flanged type

d 60 ~ 80 mm

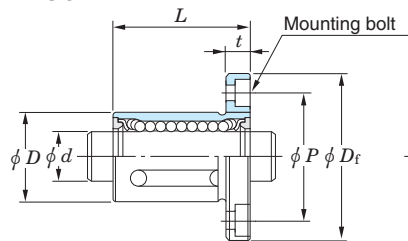

SDMF, SDMK

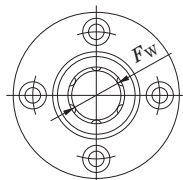

Round-flanged

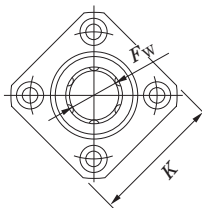

Square-flanged

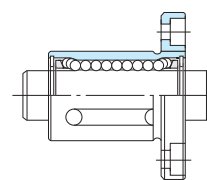

SDMF...MG
SDMK...MG (Synthetic resin)

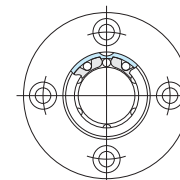

Round-flanged

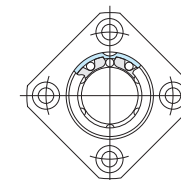

Square-flanged

Shaft dia. (mm)	Dimensions (mm)							Bolt size	Bearing No.		No. of ball rows	Basic load ratings (N)		(Refer.) Mass (g) Round-flanged type
	F_w	D	L	D_f	K	t	P		Round-flanged type	Square-flanged type		C_r	C_{0r}	
60	60	90	110	134	106	18	112	M10	SDMF60	SDMK60	6	5 170	9 030	2 800
80	80	120	140	164	136	18	142	M10	SDMF80	SDMK80	6	8 180	12 800	5 400

Locknuts, lockwashers & lock plates

Bearings are often fit to a shaft with an adapter sleeve, locknut, lockwasher or lock plate.

These accessories make it easy to attach and remove bearings.

They are standardized in JIS.

- Locknuts are standardized such that they can be used with either adapter sleeves, withdrawal sleeves or shafts.
- Lockwashers and lock plates are used as locks on locknuts.

Lockwashers are used with bearings of bore diameter number 40 or lower. Lock plates are used with those of bore diameter 44 or higher.

Locknuts

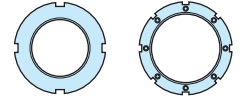

AN (ANL) 02 - 100

HN (HNL) 41 - 110

Lockwashers and lock plates

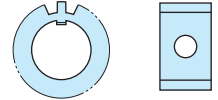

AW (AWL) 00 - 40(X)

AL (ALL) 44 - 100



Locknuts
for adapter sleeves and shafts

AN02 ~ 25

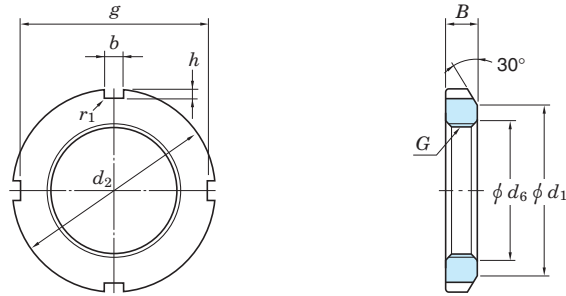

Locknut No.	Thread size ¹⁾ G	Standard dimensions (mm)								(Refer.) Mass (kg)	Applicable ²⁾ adapter sleeve (bore No.)	Applicable ³⁾ lockwasher No.
		d ₂	d ₁	g	d ₆	b	h	B	r ₁ max.			
AN 02	M 15×1	25	21	21	15.5	4	2	5	0.4	0.010	—	AW 02
03	M 17×1	28	24	24	17.5	4	2	5	0.4	0.013	—	03
04	M 20×1	32	26	28	20.5	4	2	6	0.4	0.019	04	04
AN 05	M 25×1.5	38	32	34	25.8	5	2	7	0.4	0.025	05	AW 05
06	M 30×1.5	45	38	41	30.8	5	2	7	0.4	0.043	06	06
07	M 35×1.5	52	44	48	35.8	5	2	8	0.4	0.053	07	07
AN 08	M 40×1.5	58	50	53	40.8	6	2.5	9	0.5	0.085	08	AW 08
09	M 45×1.5	65	56	60	45.8	6	2.5	10	0.5	0.119	09	09
10	M 50×1.5	70	61	65	50.8	6	2.5	11	0.5	0.148	10	10
AN 11	M 55×2	75	67	69	56	7	3	11	0.5	0.158	11	AW 11
12	M 60×2	80	73	74	61	7	3	11	0.5	0.174	12	12
13	M 65×2	85	79	79	66	7	3	12	0.5	0.203	13	13
AN 14	M 70×2	92	85	85	71	8	3.5	12	0.5	0.242	14	AW 14
15	M 75×2	98	90	91	76	8	3.5	13	0.5	0.287	15	15
16	M 80×2	105	95	98	81	8	3.5	15	0.6	0.397	16	16
AN 17	M 85×2	110	102	103	86	8	3.5	16	0.6	0.451	17	AW 17
18	M 90×2	120	108	112	91	10	4	16	0.6	0.556	18	18
19	M 95×2	125	113	117	96	10	4	17	0.6	0.658	19	19
AN 20	M100×2	130	120	122	101	10	4	18	0.6	0.698	20	AW 20
21	M105×2	140	126	130	106	12	5	18	0.7	0.845	21	21
22	M110×2	145	133	135	111	12	5	19	0.7	0.965	22	22
AN 23	M115×2	150	137	140	116	12	5	19	0.7	1.01	—	AW 23
24	M120×2	155	138	145	121	12	5	20	0.7	1.08	24	24
25	M125×2	160	148	150	126	12	5	21	0.7	1.19	—	25

[Notes] 1) Basic profile and dimension of screw thread are in accordance with JIS B 0205.

2) Applicable to adapter sleeve series A31, A2, A3 and A23.

3) Applicable to lockwashers with flat inner tongue.

[Remark] Locknut series AN is used for adapter assembly series H2, H3, H23 and H31, while locknut series ANL is used for adapter assembly series H30.

AN 26 ~ 40

ANL24 ~ 40

Locknut No.	Thread size ¹⁾ G	Standard dimensions (mm)								(Refer.) Mass (kg)	Applicable ²⁾ adapter sleeve (bore No.)	Applicable ³⁾ lockwasher No.
		d ₂	d ₁	g	d ₆	b	h	B	r ₁ max.			
AN 26	M130×2	165	149	155	131	12	5	21	0.7	1.25	26	AW 26
AN 27	M135×2	175	160	163	136	14	6	22	0.7	1.55	—	AW 27
28	M140×2	180	160	168	141	14	6	22	0.7	1.56	28	28
AN 29	M145×2	190	172	178	146	14	6	24	0.7	1.80	—	AW 29
30	M150×2	195	171	183	151	14	6	24	0.7	2.03	30	30
31	M155×3	200	182	186	156.5	16	7	25	0.7	2.30	—	—
AN 32	M160×3	210	182	196	161.5	16	7	25	0.7	2.59	32	AW 32
33	M165×3	210	193	196	166.5	16	7	26	0.7	2.70	—	—
34	M170×3	220	193	206	171.5	16	7	26	0.7	2.80	34	34
AN 36	M180×3	230	203	214	181.5	18	8	27	0.7	3.07	36	AW 36
38	M190×3	240	214	224	191.5	18	8	28	0.7	3.39	38	38
40	M200×3	250	226	234	201.5	18	8	29	0.7	3.69	40	40
ANL24	M120×2	145	133	135	121	12	5	20	0.7	0.78	24	AWL24
26	M130×2	155	143	145	131	12	5	21	0.7	0.88	26	26
28	M140×2	165	151	153	141	14	6	22	0.7	0.99	28	28
ANL30	M150×2	180	164	168	151	14	6	24	0.7	1.33	30	AWL30
32	M160×3	190	174	176	161.5	16	7	25	0.7	1.56	32	32
34	M170×3	200	184	186	171.5	16	7	26	0.7	1.72	34	34
ANL36	M180×3	210	192	194	181.5	18	8	27	0.7	1.95	36	AWL36
38	M190×3	220	202	204	191.5	18	8	28	0.7	2.08	38	38
40	M200×3	240	218	224	201.5	18	8	29	0.7	2.98	40	40

Locknuts
for adapter sleeves and shafts

AN 44 ~ 100

ANL 44 ~ 76

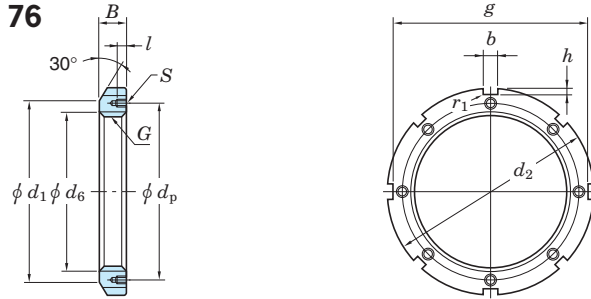

ANL 80 ~ 100

Locknut No.	Thread ¹⁾ size G	Standard dimensions (mm)								Tapped hole ²⁾ (mm)			(Refer.) Mass (kg)	Applicable adapter sleeve ³⁾ (bore No.)	Applicable lock plate No.
		d ₂	d ₁	g	d ₆	b	h	B	r _{1 max.}	l	S Thread size	d _p			
AN 44	Tr220×4	280	250	260	222	20	10	32	0.8	15	M 8×1.25	238	5.16	44	AL 44
48	Tr240×4	300	270	280	242	20	10	34	0.8	15	M 8×1.25	258	5.91	48	44
52	Tr260×4	330	300	306	262	24	12	36	0.8	18	M10×1.5	281	7.99	52	52
AN 56	Tr280×4	350	320	326	282	24	12	38	0.8	18	M10×1.5	301	8.99	56	AL 52
60	Tr300×4	380	340	356	302	24	12	40	0.8	18	M10×1.5	326	11.7	60	60
64	Tr320×5	400	360	376	322.5	24	12	42	0.8	18	M10×1.5	345	13.0	64	64
AN 68	Tr340×5	440	400	410	342.5	28	15	55	1	21	M12×1.75	372	23.0	68	AL 68
72	Tr360×5	460	420	430	362.5	28	15	58	1	21	M12×1.75	392	25.0	72	68
76	Tr380×5	490	450	454	382.5	32	18	60	1	21	M12×1.75	414	30.8	76	76
AN 80	Tr400×5	520	470	484	402.5	32	18	62	1	27	M16×2	439	36.7	80	AL 80
84	Tr420×5	540	490	504	422.5	32	18	70	1	27	M16×2	459	43.3	84	80
88	Tr440×5	560	510	520	442.5	36	20	70	1	27	M16×2	477	45.1	88	88
AN 92	Tr460×5	580	540	540	462.5	36	20	75	1	27	M16×2	497	50.2	92	AL 88
96	Tr480×5	620	560	580	482.5	36	20	75	1	27	M16×2	527	62.0	96	96
100	Tr500×5	630	580	584	502.5	40	23	80	1	27	M16×2	539	63.1	/500	100
ANL44	Tr220×4	260	242	242	222	20	9	30	0.8	12	M 6×1	229	3.09	44	ALL44
48	Tr240×4	290	270	270	242	20	10	34	0.8	15	M 8×1.25	253	5.16	48	48
52	Tr260×4	310	290	290	262	20	10	34	0.8	15	M 8×1.25	273	5.67	52	48
ANL56	Tr280×4	330	310	310	282	24	10	38	0.8	15	M 8×1.25	293	6.78	56	ALL56
60	Tr300×4	360	336	336	302	24	12	42	0.8	15	M 8×1.25	316	9.62	60	60
64	Tr320×5	380	356	356	322.5	24	12	42	0.8	15	M 8×1.25	335	9.94	64	64
ANL68	Tr340×5	400	376	376	342.5	24	12	45	1	15	M 8×1.25	355	11.7	68	ALL64
72	Tr360×5	420	394	394	362.5	28	13	45	1	15	M 8×1.25	374	12.0	72	72
76	Tr380×5	450	422	422	382.5	28	14	48	1	18	M10×1.5	398	14.9	76	76

[Notes] 1) Basic profile and dimension of screw thread are in accordance with JIS B 0216.
2) Basic profile and dimension of bore with internal thread are in accordance with JIS B 0205.
3) Applicable to adapter sleeve series A31, A32, A23 and A30.

Locknut No.	Thread ¹⁾ size G	Standard dimensions (mm)								Tapped hole ²⁾ (mm)			(Refer.) Mass (kg)	Applicable adapter sleeve ³⁾ (bore No.)	Applicable lock plate No.
		d ₂	d ₁	g	d ₆	b	h	B	r _{1 max.}	l	S Thread size	d _p			
ANL80	Tr400×5	470	442	442	402.5	28	14	52	1	18	M10×1.5	418	16.9	80	ALL76
84	Tr420×5	490	462	462	422.5	32	14	52	1	18	M10×1.5	438	17.4	84	84
88	Tr440×5	520	490	490	442.5	32	15	60	1	21	M12×1.75	462	26.2	88	88
ANL92	Tr460×5	540	510	510	462.5	32	15	60	1	21	M12×1.75	482	26.9	92	ALL88
96	Tr480×5	560	530	530	482.5	36	15	60	1	21	M12×1.75	502	28.3	96	96
100	Tr500×5	580	550	550	502.5	36	15	68	1	21	M12×1.75	522	33.6	/500	96

Locknuts
for withdrawal sleeves

HN 42 ~ 110
HNL 41 ~ 64

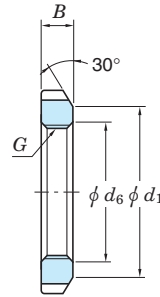
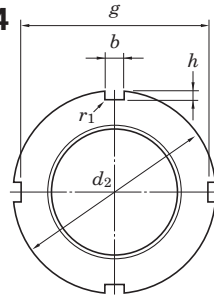

HNL 69 ~ 108

Locknut No.	Thread ¹⁾ size G	Standard dimensions (mm)								(Refer.) Mass (kg)	Withdrawal sleeve No.			
		d ₂	d ₁	g	d ₆	b	h	B	r _{1 max.}					
HN 42	Tr210×4	270	238	250	212	20	10	30	0.8	4.75	AH3138	AH2238	AH3238	AH2338
44	Tr220×4	280	250	260	222	20	10	32	0.8	5.35	3140	2240	3240	2340
48	Tr240×4	300	270	280	242	20	10	34	0.8	6.20	3144	2244	—	2344
HN 52	Tr260×4	330	300	306	262	24	12	36	0.8	8.55	AH3148	AH2248	—	AH2348
58	Tr290×4	370	330	346	292	24	12	40	0.8	11.8	3152	2252	—	2352
62	Tr310×5	390	350	366	312.5	24	12	42	0.8	13.4	3156	2256	—	2356
HN 66	Tr330×5	420	380	390	332.5	28	15	52	1	20.4	AH3160	AH2260	AH3260	—
70	Tr350×5	450	410	420	352.5	28	15	55	1	25.2	3164	2264	3264	—
74	Tr370×5	470	430	440	372.5	28	15	58	1	28.2	3168	—	3268	—
HN 80	Tr400×5	520	470	484	402.5	32	18	62	1	40.0	AH3172	—	AH3272	—
84	Tr420×5	540	490	504	422.5	32	18	70	1	46.9	3176	—	3276	—
88	Tr440×5	560	510	520	442.5	36	20	70	1	48.5	3180	—	3280	—
HN 92	Tr460×5	580	540	540	462.5	36	20	75	1	55.0	AH3184	—	AH3284	—
96	Tr480×5	620	560	580	482.5	36	20	75	1	67.0	X3188	—	X3288	—
102	Tr510×6	650	590	604	513	40	23	80	1	75.0	X3192	—	X3292	—
HN 106	Tr530×6	670	610	624	533	40	23	80	1	78.0	AHX3196	—	AHX3296	—
110	Tr550×6	700	640	654	553	40	23	80	1	92.5	X31/500	—	X32/500	—
HNL 41	Tr205×4	250	232	234	207	18	8	30	0.8	3.43	AH3038	AH238	—	—
43	Tr215×4	260	242	242	217	20	9	30	0.8	3.72	3040	240	—	—
47	Tr235×4	280	262	262	237	20	9	34	0.8	4.60	3044	244	—	—
HNL 52	Tr260×4	310	290	290	262	20	10	34	0.8	5.80	AH3048	AH248	—	—
56	Tr280×4	330	310	310	282	24	10	38	0.8	6.72	3052	252	—	—
60	Tr300×4	360	336	336	302	24	12	42	0.8	9.60	3056	256	—	—
HNL 64	Tr320×5	380	356	356	322.5	24	12	42	1	10.3	AH3060	—	—	—

Locknut No.	Thread ¹⁾ size G	Standard dimensions (mm)								(Refer.) Mass (kg)	Withdrawal sleeve No.			
		d ₂	d ₁	g	d ₆	b	h	B	r _{1 max.}					
HNL 69	Tr345×5	410	384	384	347.5	28	13	45	1	11.5	3064	—	—	—
73	Tr365×5	430	404	404	367.5	28	13	48	1	14.2	3068	—	—	—
HNL 77	Tr385×5	450	422	422	387.5	28	14	48	1	15.0	AH3072	—	—	—
82	Tr410×5	480	452	452	412.5	32	14	52	1	19.0	3076	—	—	—
86	Tr430×5	500	472	472	432.5	32	14	52	1	19.8	3080	—	—	—
HNL 90	Tr450×5	520	490	490	452.5	32	15	60	1	23.8	AH3084	—	—	—
94	Tr470×5	540	510	510	472.5	32	15	60	1	25.0	X3088	—	—	—
98	Tr490×5	580	550	550	492.5	36	15	60	1	34.0	X3092	—	—	—
HNL104	Tr520×6	600	570	570	523	36	15	68	1	37.0	AHX3096	—	—	—
108	Tr540×6	630	590	590	543	40	20	68	1	43.5	X30/500	—	—	—

[Note] 1) Basic profile and dimension of screw thread are in accordance with JIS B 0216.
[Remark] Number of slots on nut may sometimes exceed that shown in the figure.

Lockwashers

AW 00 ~ 24(X)

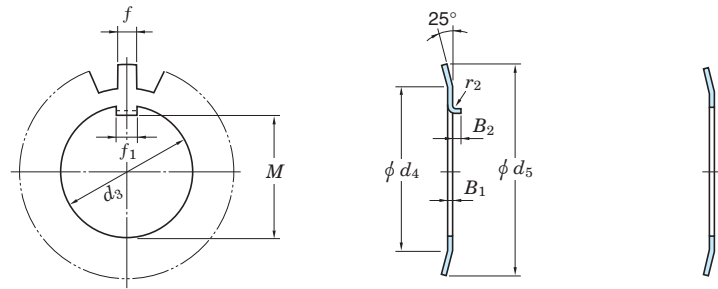

With bent inner tongue

With flat inner tongue

AW 25 ~ 40(X)

AWL24 ~ 40(X)

Lockwasher No.	Standard dimensions (mm)										No. of tooth	(Refer.) Mass (kg/100pcs.)	Applicable adapter sleeve (bore No.)	Applicable locknut No.
	With bent inner tongue	With flat inner tongue	d_3	M	f_1	B_1	f	d_4	d_5	r_2				
AW 00	AW 00X	10	8.5	3	1	3	13	21	0.5	2	9	0.131	—	AN 00
01	01X	12	10.5	3	1	3	17	25	0.5	2	9	0.192	—	01
02	02X	15	13.5	4	1	4	21	28	1	2.5	13	0.253	—	02
AW 03	AW 03X	17	15.5	4	1	4	24	32	1	2.5	13	0.313	—	AN 03
04	04X	20	18.5	4	1	4	26	36	1	2.5	13	0.350	04	04
05	05X	25	23	5	1.2	5	32	42	1	2.5	13	0.640	05	05
AW 06	AW 06X	30	27.5	5	1.2	5	38	49	1	2.5	13	0.780	06	AN 06
07	07X	35	32.5	6	1.2	5	44	57	1	2.5	15	1.04	07	07
08	08X	40	37.5	6	1.2	6	50	62	1	2.5	15	1.23	08	08
AW 09	AW 09X	45	42.5	6	1.2	6	56	69	1	2.5	17	1.52	09	AN 09
10	10X	50	47.5	6	1.2	6	61	74	1	2.5	17	1.60	10	10
11	11X	55	52.5	8	1.2	7	67	81	1	4	17	1.96	11	11
AW 12	AW 12X	60	57.5	8	1.5	7	73	86	1.2	4	17	2.53	12	AN 12
13	13X	65	62.5	8	1.5	7	79	92	1.2	4	19	2.90	13	13
14	14X	70	66.5	8	1.5	8	85	98	1.2	4	19	3.34	14	14
AW 15	AW 15X	75	71.5	8	1.5	8	90	104	1.2	4	19	3.56	15	AN 15
16	16X	80	76.5	10	1.8	8	95	112	1.2	4	19	4.64	16	16
17	17X	85	81.5	10	1.8	8	102	119	1.2	4	19	5.24	17	17
AW 18	AW 18X	90	86.5	10	1.8	10	108	126	1.2	4	19	6.23	18	AN 18
19	19X	95	91.5	10	1.8	10	113	133	1.2	4	19	6.70	19	19
20	20X	100	96.5	12	1.8	10	120	142	1.2	6	19	7.65	20	20
AW 21	AW 21X	105	100.5	12	1.8	12	126	145	1.2	6	19	8.26	21	AN 21
22	22X	110	105.5	12	1.8	12	133	154	1.2	6	19	9.40	22	22
23	23X	115	110.5	12	2	12	137	159	1.5	6	19	10.8	—	23
AW 24	AW 24X	120	115	14	2	12	138	164	1.5	6	19	10.5	24	AN 24

Lockwasher No.	Standard dimensions (mm)										No. of tooth	(Refer.) Mass (kg/100pcs.)	Applicable adapter sleeve (bore No.)	Applicable locknut No.
	With bent inner tongue	With flat inner tongue	d_3	M	f_1	B_1	f	d_4	d_5	r_2				
AW 25	AW 25X	125	120	14	2	12	148	170	1.5	6	19	11.8	—	25
26	26X	130	125	14	2	12	149	175	1.5	6	19	11.3	26	26
AW 27	AW 27X	135	130	14	2	14	160	185	1.5	6	19	14.4	—	AN 27
28	28X	140	135	16	2	14	160	192	1.5	8	19	14.2	28	28
29	29X	145	140	16	2	14	172	202	1.5	8	19	16.8	—	29
AW 30	AW 30X	150	145	16	2	14	171	205	1.5	8	19	15.5	30	AN 30
31	31X	155	147.5	16	2.5	16	182	212	1.5	8	19	20.9	—	31
32	32X	160	154	18	2.5	16	182	217	1.5	8	19	22.2	32	32
AW 33	AW 33X	165	157.5	18	2.5	16	193	222	1.5	8	19	24.1	—	AN 33
34	34X	170	164	18	2.5	16	193	232	1.5	8	19	24.7	34	34
36	36X	180	174	20	2.5	18	203	242	1.5	8	19	26.8	36	36
AW 38	AW 38X	190	184	20	2.5	18	214	252	1.5	8	19	27.8	38	AN 38
40	40X	200	194	20	2.5	18	226	262	1.5	8	19	29.3	40	40

AWL24	AWL24X	120	115	14	2	12	133	155	1.5	6	19	7.70	24	ANL24
26	26X	130	125	14	2	12	143	165	1.5	6	19	8.70	26	26
28	28X	140	135	16	2	14	151	175	1.5	8	19	10.9	28	28
AWL30	AWL30X	150	145	16	2	14	164	190	1.5	8	19	11.3	30	ANL30
32	32X	160	154	18	2.5	16	174	200	1.5	8	19	16.2	32	32
34	34X	170	164	18	2.5	16	184	210	1.5	8	19	19.0	34	34
AWL36	AWL36X	180	174	20	2.5	18	192	220	1.5	8	19	18.0	36	ANL36
38	38X	190	184	20	2.5	18	202	230	1.5	8	19	20.5	38	38
40	40X	200	194	20	2.5	18	218	250	1.5	8	19	21.4	40	40

(Remark) 1) AW00~AW40, AW00X~AW40X are applicable to adapter assembly series H31, H2, H3 and H23.
 2) AWL24~AWL40, AWL24X~AWL40X are applied to adapter assembly series H30.
 3) For adapter sleeves with narrow slits, lockwashers with flat inner tongue should be used. Either type of lockwasher can be used for adapter sleeves with wide slits.

Lock plates

AL 44 ~ 100

ALL44 ~ 96

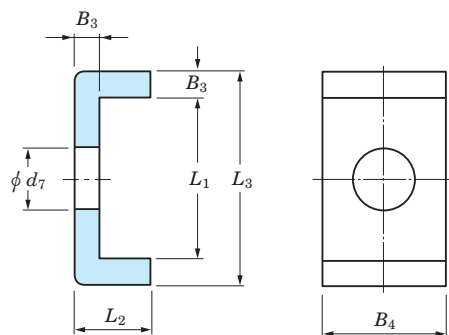

Lock plate No.	Standard dimensions (mm)						(Refer.) Mass (kg/100pcs.)	Applicable locknut No.
	B_3	B_4	L_2	d_7	L_1	L_3		
AL 44	4	20	12	9	22.5	30.5	2.60	AN 44,48
52	4	24	12	12	25.5	33.5	3.39	52,56
60	4	24	12	12	30.5	38.5	3.79	60
AL 64	5	24	15	12	31	41	5.35	AN 64
68	5	28	15	14	38	48	6.65	68,72
76	5	32	15	14	40	50	7.96	76
AL 80	5	32	15	18	45	55	8.20	AN 80,84
88	5	36	15	18	43	53	9.00	88,92
96	5	36	15	18	53	63	10.4	96
100	5	40	15	18	45	55	10.5	100
ALL44	4	20	12	7	13.5	21.5	2.12	ANL44
48	4	20	12	9	17.5	25.5	2.29	48,52
56	4	24	12	9	17.5	25.5	2.92	56
ALL60	4	24	12	9	20.5	28.5	3.16	ANL60
64	5	24	15	9	21	31	4.56	64,68
72	5	28	15	9	20	30	5.03	72
ALL76	5	28	15	12	24	34	5.28	ANL76,80
84	5	32	15	12	24	34	6.11	84
88	5	32	15	14	28	38	6.45	88,92
96	5	36	15	14	28	38	7.29	96,100

[Remark] Lock plate series AL are applicable to adapter assembly series H31, H32 and H23, while lock plate series ALL are applicable to H30.

Exsev&Ceramic bearing series

More and more bearings are being used in extreme special environments, such as in a vacuum, or in a clean, corrosive, or heated place. In some cases bearings are required to be insulated or antimagnetic.

Applications of bearings in such environments are increasing in the field of state-of-the-art technology, e.g. vacuum equipment, aerospace equipment and semi-conductor production facilities. Bearings made of conventional materials and lubricants can hardly meet these new needs.

JTEKT has succeeded in developing a series of bearings for use in extreme special environments, having started from the study of the very basics of materials and testing of their performance under various severe conditions.

JTEKT has standardized the following bearings as the "Koyo **EXSEV** bearing series".

- Exsev bearings for use in a clean environment
Designed for use in a vacuum. The friction surface of the bearing interior is coated with solid lubricant (or soft metal). Bearings pre-lubricated with special grease are also available.
- Exsev bearings for use in a vacuum environment
Produce insignificant contamination, provided with rolling elements and a cage made of self-lubricating materials. Optimal for use in environments which need to be clean.
- Ceramic bearings
Ceramic rings and rolling elements (silicon nitride Si_3N_4) ensure excellent performance in various extreme special environments.

Exsev bearings for use in a vacuum environment



Exsev bearings for use in a clean environment

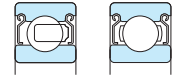

Ceramic bearings

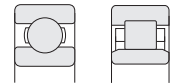

Linear ball bearings for vacuum

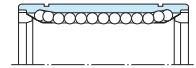

For details, refer to JTEKT separate catalog "**EXSEV** bearings and Ceramic bearings for extreme special environments" (CAT. NO. B2004E).



Bearings for machine tool spindles (for support of axial loading)

JTEKT supplies double direction angular contact thrust ball bearings and ACT type matched pair angular contact ball bearings which are used with machine tool spindles to support axial loading.

These bearings were developed to meet needs which have grown as machine tool spindle rotation has become faster and more accurate.

Several dimension series are available for selection according to operating conditions.

Double direction angular contact thrust ball bearings



Matched pair angular contact ball bearing (ACT type)

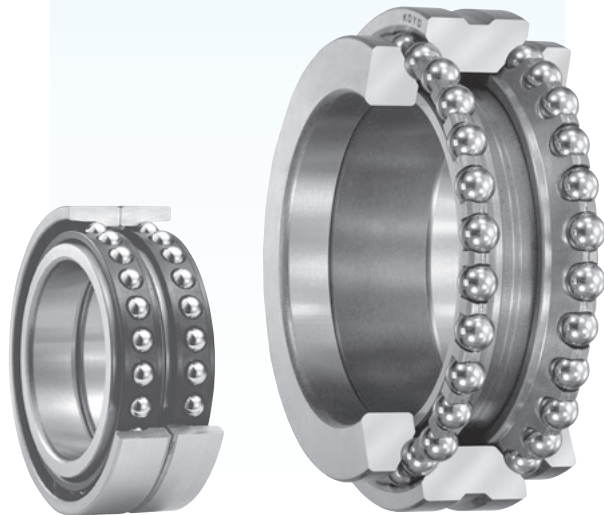

For details, refer to JTEKT separate catalog "Precision Ball and Roller Bearings for Machine Tools" (CAT. NO. B2005E).



Precision ball screw support bearings and bearing units

Support bearings

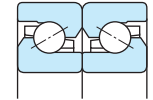

Support bearing units

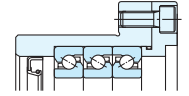

■ Support bearings were developed to support precision ball screw shafts. They have the same structure as angular contact thrust ball bearings with a contact angle of 60°.

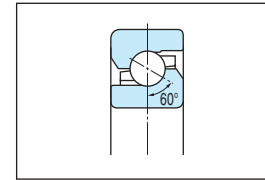

- Have a large axial load carrying capacity. Also able to carry a certain degree of radial load.
- Highly rigid in the axial direction.
- Starting torque is small.

■ Support bearing units consist of the bearings described above and a precisely processed housing. Units with a Koyo precision ball screw are also available.

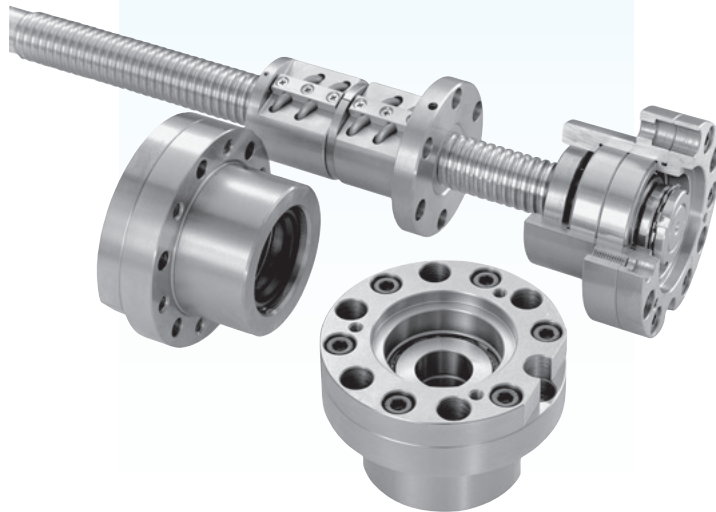

For details, refer to JTEKT separate catalog "Precision Ball and Roller Bearings for Machine Tools" (CAT. NO. B2005E).



Full complement type cylindrical roller bearings for crane sheaves

Crane rope sheaves and running wheels which are operated at low or medium speed are generally equipped with full complement type cylindrical roller bearings because the operation of these machines involves heavy, impact loading.

These bearings are divided into shielded and open types. The shielded type is often used with the outer ring rotation.

Shielded type

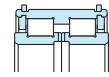

Open type



■ Shielded type

- The shielded type was developed for use with rope sheaves. It is shielded, non-separable and pre-lubricated with grease.
- Bearings with locating snap rings around the outer ring can be positioned and fit to sheaves with ease.
- The bearing surface is coated with phosphate for rust prevention.

■ Open type

- Open type bearings are further divided into those used on the fixed side and those used on the free side. The former carry axial load in both directions. The relative position of the latter's inner ring and outer ring can be adjusted by moving them along the axis.
- Open type bearings are separable because the outer ring divided into two annular pieces in a plane perpendicular to its axis. Triple-row and four-row bearings are available along with double-row types.

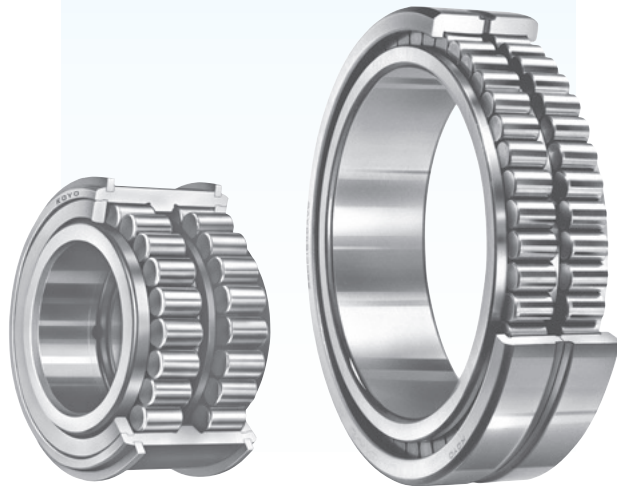

For details, refer to JTEKT separate catalog "Large size ball & roller bearings" (CAT. NO. B2002E).



Rolling mill roll neck bearings

Rolling mill roll neck four-row cylindrical roller bearings and tapered roller bearings are designed to achieve the maximum load rating capacity in a limited space.

- Four-row cylindrical roller bearings
 - Suitable for high-speed rotation. Thin section designs are also available.
 - The inner ring raceway surface and the roll can be finished simultaneously after the inner ring is mounted on the roll neck. This feature is useful in improving rolling mill accuracy.
- Four-row tapered roller bearings
 - Suitable for low- and medium-speed rotation. Available in both metric and inch series.
 - The internal clearance is preadjusted, facilitating mounting.
 - More sealed type four-row tapered roller bearings are being used currently.

Four-row cylindrical roller bearings

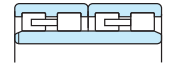

Cylindrical bore

Four-row tapered roller bearings

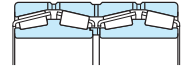

Open type

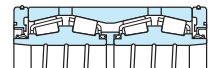

Sealed type

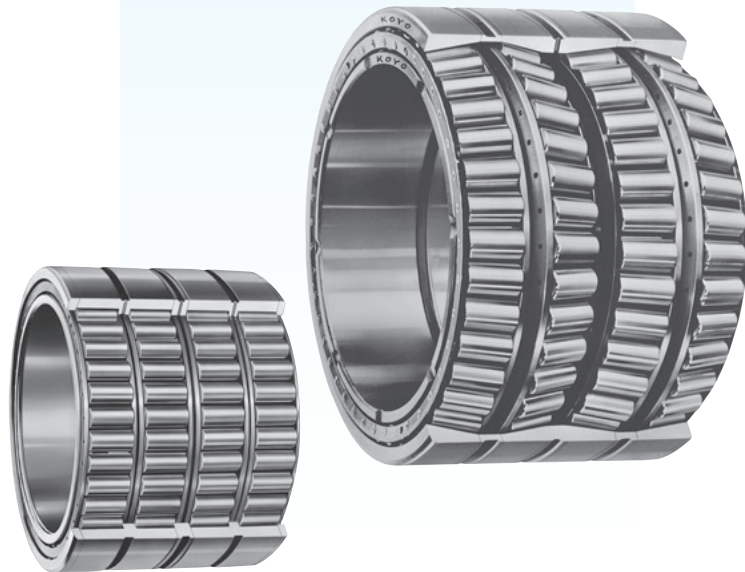

For details, refer to JTEKT separate catalog "Roll neck bearings for rolling mill" (CAT. NO. B2013E).



Introduction of pamphlets and catalogs

Bearings

1) General Bearings

Large size ball & roller bearings

(CAT.NO.B2002E)



This catalog provides information on various large size ball and roller bearings for purposes such as steel making equipment, equipment for wind-power generation, civil engineering and construction machinery, and other large industrial machineries. It contains large size bearings with bore diameter of 100 mm or more.

Needle roller bearings

(CAT.NO.B2020E)

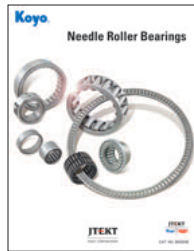

More useful catalog of needle roller bearings as the Koyo brand.

The products published to the catalog

- Radial needle roller and cage assemblies
- Drawn cup needle roller bearings
- Drawn cup roller clutches
- Heavy-duty needle roller bearings
- Track rollers
- Thrust bearings, assemblies, washers
- Combined needle roller bearings
- Needle rollers, accessories

Inch series tapered roller bearings

(CAT.NO.B2009E)



This is the special catalog for tapered roller bearings containing frequently used series in addition to the products included in the "Ball & Roller Bearings" catalog (CAT.NO.B2001E), for improvement in the contents and easier reference.

EXSEV BEARINGS AND CERAMIC BEARINGS

(CAT.NO.B2004E)

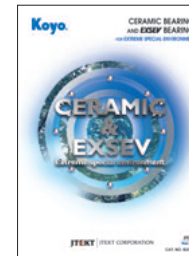

Suitable for use in special environments, such as clean room, vacuum, high-temperature, or chemical. Available in sizes of 4 mm to 40 mm bearing bore.

EXSEV product guidebook

(CAT.NO.B1005E)



This is a summarized version of EXSEV BEARINGS AND CERAMIC BEARINGS FOR EXTREME SPECIAL ENVIRONMENTS (Cat. No.B2004E). Please utilize this guidebook when selecting bearings.

CERAMIC BEARINGS

(CAT.NO.B1013E)



This pamphlet is targeting and introducing ceramic bearings. For the easy selection, this pamphlet is introducing ceramic bearings at each use. The following contents are included in this pamphlet:

- Ceramics Production Processes
- Properties of ceramic materials
- Features

JHS series RZ-type spherical roller bearings

(CAT.NO.B2023E)



This pamphlet introduces our "JHS Series" RZ-type Spherical Roller Bearings, which are a new generation of high-performance bearings made possible with advanced designs and processing technologies. In addition to introducing the JHS Series, this pamphlet will also explain the features and structures of JHS Series RZ-type Spherical Roller Bearings.

2) Products for Steel Production Equipment**High-performance product series for steel production/rolling equipment**

(CAT.NO.B1001E)



In this pamphlet, we will introduce high-performance products (bearings, drive shafts, and oil seals) that contribute to stable operations of steel production equipment. This pamphlet contains two parts: an overall introduction and product introduction.

Products to be introduced include the following

- Bearings for roll necks
- Drive shafts for rolling mills
- Bearings for backing shafts of cluster mills
- Products for continuous casting machines

Cylindrical roller bearings for multi-roll mill backup rolls

(CAT.NO.B2012E)



Special designed bearings for multi-roll mill backup rolls. The outer ring is made of special material and is heat-treated for surface hardness to ensure impact resistance, and thus reliability. In addition, JHS210 bearings meet the needs of our customers for long service lives. This catalog provides information on the handling of the bearings (key points for the disassembling and inspecting of the bearings) as well as actual examples of bearing failures and countermeasures.

Roll neck bearings for rolling mill

(CAT.NO.B2013E)



This bearing is used for rolling mill roll necks. This catalog includes data about countermeasures for damages particular to this application as well as dimensions tables.

Drive shafts for steel production/industrial equipment

(CAT.NO.B2021E)



Drive shafts for steel production/industrial equipment are included in this catalog. Products line up, handling explanation cases of failures, technical data that includes selection criteria for each application are shown in this catalog. Also, specifications, product introduction (phase adjustment, hyper coupling), etc are shown in this catalog. This catalog can widely be used for from drive shaft selection to maintenance.

Oil seal for steel production equipment

(CAT.NO.B1020E)



This pamphlet introduces oil seals that are used in steel production equipment. This pamphlet includes features and other information on products used in the following equipment:

- Rolling Mill
- Continuous Casting Machines
- Sintering Machine Pallet Cars and Converter Furnaces

JHS series hyper coupling

(CAT.NO.B1010E)



The hyper coupling is a torque limiter (cut-off device) that protects drive systems for heavy loads. This catalog will show you operating principles, features of the products, examples of the applications, and the product lineup.

3) General Industrial equipment

New ceramic ball bearings for electric motors

(CAT.NO.B1017E)



This pamphlet introduces our new ceramic ball bearings which have similar insulation properties to conventional ceramic ball bearings (silicon nitride), and their thermal expansion is close to that of steel ball bearings, so that there is very little change in clearance due to temperature.

Low-torque Long-life deep groove ball bearings for electric motors

(CAT.NO.B1018E)



This pamphlet introduces our new deep groove ball bearings, with optimized grease composition which greatly reduces torque and extends service life, and also reduces energy consumption by the motor and contributes to reducing the need for maintenance.

Slim Bearing

(CAT.NO.B1021E)

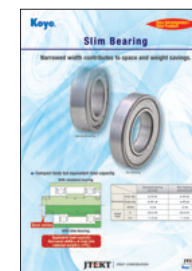

This pamphlet introduces our slim bearings for which the seal groove width has been reduced by welding the shield directly to the outer ring instead of attaching the shield to the outer ring seal groove.

Motor-use Deep Groove Ball Bearings with Optimized Sound Output

(CAT.NO.B1022E)



This pamphlet introduces our deep groove ball bearings for which sound from unpleasant frequencies to the human ear has been reduced by optimizing the inner raceway surface through the use of 3D analysis.

Products for machine tools

(CAT.NO.B1016E)



This pamphlet introduces JTEKT's products for machine tools.

Contents

- Changes in Spindle Technologies
- Introduction to High-ability NX Series (Ultra-high speed angular ball bearings and ultra-high speed cylindrical roller bearings)
- Introduction to bearings for spindle
- Introduction to ball screw-related products and spindle unit products
- Product line-up

Precision ball & roller bearings for machine tools

(CAT.NO.B2005E)



This catalog includes high precision products such as cylindrical roller bearings and angular contact ball bearings, that are used for spindles of machine tools, and support bearing for precision ball screws. This catalog gives technical descriptions including references for handling of bearings such as the guideline for selection of bearing, example of bearing installation, and example of bearing failures.

Products for Wind Turbine Generators

(CAT.NO.B1002E)



This catalog introduces main shaft bearings, gearbox bearings, and generator bearings for wind turbine generators.

The catalog also includes main shaft oil seals, hydraulic pumps, and machine tools for large components of wind turbine generators.

Product information for agricultural and construction equipment

(CAT.NO.B1009E)



This catalog is introducing the function needed to an agricultural machine and a construction machine, our technology and goods.

- Optimum design technologies (High performance tapered roller bearing)
- Heat treatment technologies (KE bearing, SH bearing)
- Analysis technologies, Surface reforming technology
- JHS Series Spherical Roller Bearings
- Propeller shaft for construction machinery, Oil seal, Hydraulic Components

High Wing Series Drive Shafts

(CAT.NO.B2022E)



Drive shafts for construction machinery/railway rolling stocks are included in this catalog.

Products line up, handling explanation, technical data that include cases of failures, specifications, etc are shown in this catalog.

This catalog can widely be used for from drive shaft selection to maintenance.

Bearings for Aerospace Applications

(CAT.NO.B1003JE)



This pamphlet introduces bearings that are used in airplanes and in space. The bearing usage locations and the airplane eras are gathered together and introduced in lists.

Miniature One-way Clutch

(CAT.NO.B2024E)



Miniature one-way clutches are used in clutch systems in various machines, including office automation equipment, ATMs, and various ticket vending machines. This catalog also includes recommended polyacetal resin and steel housing dimensions.

Ball bearing units

(CAT.NO.B2007E)



This catalog has information about ball bearing units. Technical descriptions, selection of ball bearing units, and dimensional tables of units, such as pillow block type, take-up type, cartridge type, and ball bearing for units, are included in this catalog. Stainless-series and "compact" series are also included in this catalog.

Traction drive unit

(CAT.NO.B1011E)



A Traction Drive Unit has been conceived from bearing core technologies. A reducer with a minimal rotation irregularity is suitable for high-accuracy feeding, which is unachievable by using gears.

Oil seals & o-rings

(CAT.NO.R2001E)



This catalog includes oil seals, o-rings and back up rings. Includes dimensional tables, technical explanations and handling information.

4) Automotive Components

The 3rd generation ball hub units

(CAT.NO.B1004E)



This pamphlet introduces the main characteristics and design of the 3rd generation ball type hub units. Features JTEKT's recommended hub unit numbers.

Tapered roller bearings for axle drive pinions

(CAT.NO.B1006E)

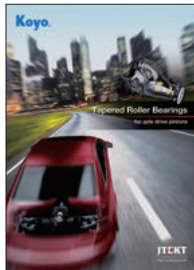

This pamphlet introduces tapered roller bearings for axle drive pinions. Technology for torque reduction and longer service life, examination and evaluation methods, and recommended series bearing numbers.

Bearings



■ Hub units



■ Clutch release bearings



■ KE bearings

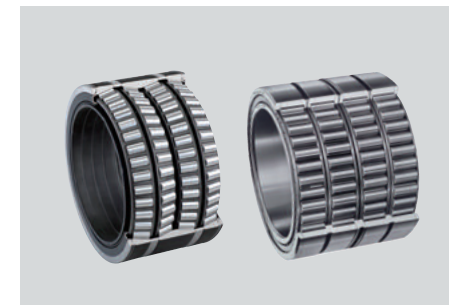

■ Roll neck bearings for rolling mill
(Steel production/rolling equipment)



■ Water pump bearings



■ Bearings for rocker arms

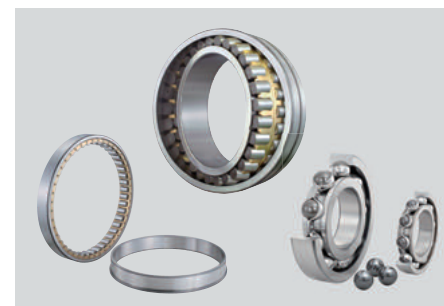

■ Bearings for wind turbine generator



■ EXSEV & Ceramic bearings



■ CPA bearings



■ LFT III bearings



■ Bearings for railway rolling stock axle journals



■ Drive shafts



■ Bearings for machine tools



■ Bearings for aircraft/aerospace



■ Electric pumps for idle-stop system



■ Pump for CVT

Automotive Components



■ Steering systems



■ TORSEN LSD



■ Linear solenoid valve for AT and CVT



■ Damper pulleys

Sensors

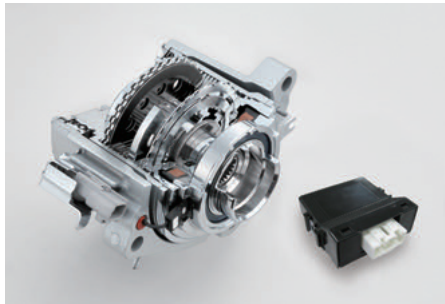

■ Intelligent torque controlled coupling (ITCC)



■ Drive shafts (CVJ)



■ Water level meters



■ Pressure sensors/Transducers

Machine tools

[Grinders]



■ Grinding center TG4



■ Cam shaft grinder GC20Mi



■ Cylindrical grinder e300G

[Machining Centers]



■ Horizontal spindle machining center FH630SX-i



■ Vertical spindle machining center FV2090S

Mechatronics

■ Programmable controller



TOYOPUC-PC10G

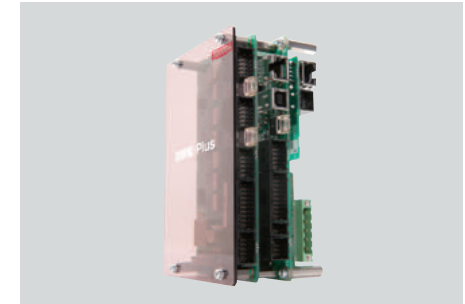

TOYOPUC-Plus



■ Direct circuit monitor



■ Small safety PLC TOYOPUC-PCS-J

Koyo Machine Industries Co., Ltd.



■ Centerless grinding machine



■ Surface grinding machine



■ Fully automatic assembly inspection system



■ Precision spindle unit



■ Drive shaft



■ Intermediate shafts



■ Ball screws



■ Indexing chuck

Toyooki Kogyo Co., Ltd.

Energy-saving hydraulic equipment



■ Small pack



■ TOYOPAC"ECO"

Inspection and testing machine



■ High performance straightening machine

Automotive components



■ Reduced wiring 4 pin connector solenoid valve



■ Toyopac motion

Koyo Sealing Techno Co., Ltd.



■ Oil seals of various types



■ O-rings of various types



■ Functional parts of various types



■ Bonded piston seals for AT and CVT

CNK Co., Ltd.

■ Loader

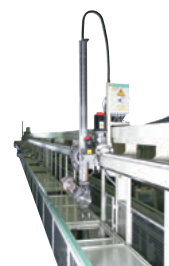

■ DLC coating equipment



■ Round eddy-current coolant system



■ Heat treatment equipment



Koyo Thermo Systems Co., Ltd.



- Vacuum heat treatment furnace
- Non-frame KCF carburizing and quenching furnaces
- Vertical diffusion systems
- Electronic device for continuous furnace
- High temperature clean oven
- Experimental small electric furnace

HOUKO Co., Ltd



- General purpose cylindrical grinders G32 series
- CNC cylindrical grinders GE3/GL3S series
- Production type Cylindrical grinders GL4E series
- CNC large cylindrical grinders GE6 series

Koyo Electronics Industries Co., Ltd.



- Rotary encoders
- Programmable controllers
- HMI
- Proximity switch

Toyoda Van Moppes Ltd.

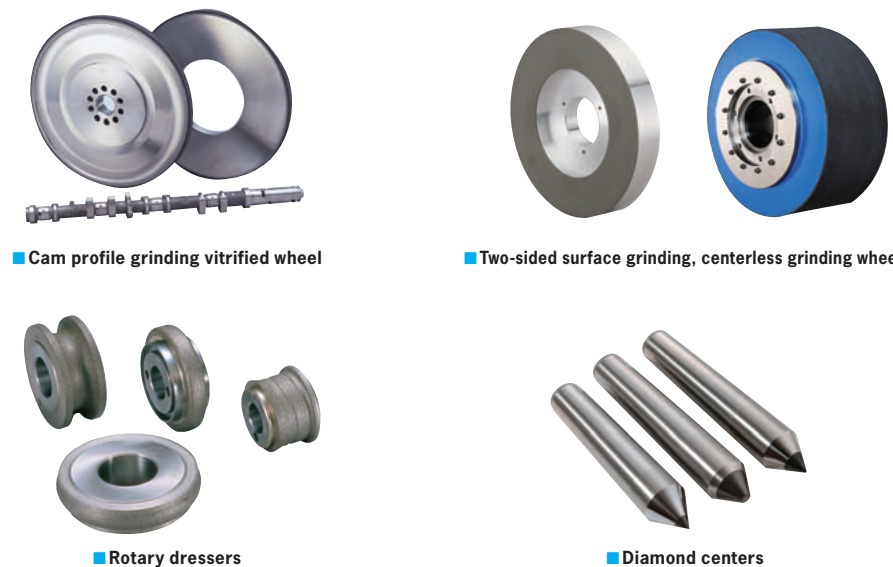

- Cam profile grinding vitrified wheel
- Two-sided surface grinding, centerless grinding wheel
- Rotary dressers
- Diamond centers

Supplementary table 1 (1) Boundary dimensions of radial bearings (except tapered roller bearings) – diameter series 7, 8, 9, 0 –

Unit : mm

Bore dia. No	Diameter series 7				Diameter series 8				Diameter series 9				Diameter series 0																
	Dimension series 17	Dimension series 27	Dimension series 37	r min.	Dimension series 08	Dimension series 18	Dimension series 28	Dimension series 38	Dimension series 48	Dimension series 58	Dimension series 68	Dimension series 09	Dimension series 19	Dimension series 29	Dimension series 39	Dimension series 49	Dimension series 59	Dimension series 69	Dimension series 00	Dimension series 10	Dimension series 20	Dimension series 30	Dimension series 40	Dimension series 50	Dimension series 60	Dimension series 10-60			
d	D	B	r	D	B	B	B	B	B	B	B	B	B	B	B	B	B	B	B	B	B	B	B	B	B	B	r min.		
Deep groove ball brg.	67																												
Angular contact ball brg.																													
Self-aligning ball brg.																													
Cylindrical roller brg.																													
Needle roller brg.																													
Spherical roller brg.																													

Bore dia. No	Diameter series 7				Diameter series 8				Diameter series 9				Diameter series 0																
	Dimension series 17	Dimension series 27	Dimension series 37	r min.	Dimension series 08	Dimension series 18	Dimension series 28	Dimension series 38	Dimension series 48	Dimension series 58	Dimension series 68	Dimension series 09	Dimension series 19	Dimension series 29	Dimension series 39	Dimension series 49	Dimension series 59	Dimension series 69	Dimension series 00	Dimension series 10	Dimension series 20	Dimension series 30	Dimension series 40	Dimension series 50	Dimension series 60	Dimension series 10-60			
d	D	B	r	D	B	B	B	B	B	B	B	B	B	B	B	B	B	B	B	B	B	B	B	B	B	B	r min.		
1	2.5	1	0.05	2.5	1	1.4	0.05	4	1.6	2.3	0.1	1.6	2.3	0.1	1.6	2.3	0.1	1.6	2.3	0.1	1.6	2.3	0.1	1.6	2.3	0.1	1.6	2.3	0.1
2	4	1.2	0.05	5	1.5	2.3	0.05	5	2	2.6	0.15	2	2.6	0.15	2	2.6	0.15	2	2.6	0.15	2	2.6	0.15	2	2.6	0.15	2	2.6	0.15
3	6	2	0.08	7	1.8	2.6	0.08	7	2.5	3.5	0.15	2.5	3.5	0.15	2.5	3.5	0.15	2.5	3.5	0.15	2.5	3.5	0.15	2.5	3.5	0.15	2.5	3.5	0.15
4	7	2	0.08	9	2.5	3.5	0.1	11	4	4	0.15	4	4	0.15	4	4	0.15	4	4	0.15	4	4	0.15	4	4	0.15	4	4	0.15
5	8	2	0.08	11	3	4	0.15	13	4	5	0.15	4	5	0.15	4	5	0.15	4	5	0.15	4	5	0.15	4	5	0.15	4	5	0.15
6	10	2.5	0.1	13	3.5	5	0.1	15	5	7	0.15	5	7	0.15	5	7	0.15	5	7	0.15	5	7	0.15	5	7	0.15	5	7	0.15
7	11	3	0.1	14	4	5	0.1	16	4	8	0.2	4	8	0.2	4	8	0.2	4	8	0.2	4	8	0.2	4	8	0.2	4	8	0.2
8	12	3	0.1	16	4	5	0.1	18	4	9	0.2	4	9	0.2	4	9	0.2	4	9	0.2	4	9	0.2	4	9	0.2	4	9	0.2
9	14	3	0.1	17	4	5	0.1	19	5	6	0.2	5	6	0.2	5	6	0.2	5	6	0.2	5	6	0.2	5	6	0.2	5	6	0.2
00	10	15	3	14	5	6	0.2	19	6	9	0.3	6	9	0.3	6	9	0.3	6	9	0.3	6	9	0.3	6	9	0.3	6	9	0.3
01	12	18	4	21	5	6	0.2	21	5	6	0.3	6	8	0.3	6	8	0.3	6	8	0.3	6	8	0.3	6	8	0.3	6	8	0.3
02	15	21	4	24	5	6	0.2	24	5	6	0.3	6	8	0.3	6	8	0.3	6	8	0.3	6	8	0.3	6	8	0.3	6	8	0.3
03	17	23	4	26	5	6	0.2	26	5	6	0.3	6	8	0.3	6	8	0.3	6	8	0.3	6	8	0.3	6	8	0.3	6	8	0.3
04	20	27	4	32	4	7	0.2	32	4	7	0.3	7	9	0.3	7	9	0.3	7	9	0.3	7	9	0.3	7	9	0.3	7	9	0.3
05	25	32	4	37	4	7	0.2	37	4	7	0.3	7	9	0.3	7	9	0.3	7	9	0.3	7	9	0.3	7	9	0.3	7	9	0.3
06	30	37	4	42	4	7	0.2	42	4	7	0.3	7	9	0.3	7	9	0.3	7	9	0.3	7	9	0.3	7	9	0.3	7	9	0.3
07	35	44	4	47	4	7	0.2	47	4	7	0.3	7	9	0.3	7	9	0.3	7	9	0.3	7	9	0.3	7	9	0.3	7	9	0.3
08	40	52	4	52	4	7	0.2	52	4	7	0.3	7	9	0.3	7	9	0.3	7	9	0.3	7	9	0.3	7	9	0.3	7	9	0.3
09	45	58	4	58	4	7	0.2	58	4	7	0.3	7	9	0.3	7	9	0.3	7	9	0.3	7	9	0.3	7	9	0.3	7	9	0.3
10	50	65	5	7	9	11	0.3	72	7	9	0.3	7	9	0.3	7	9	0.3	7	9	0.3	7	9	0.3	7	9	0.3	7	9	0.3
11	55	72	7	72	7	9	0.3	80	9	13	0.3	8	12	0.3	8	12	0.3	8	12	0.3	8	12	0.3	8	12	0.3	8	12	0.3
12	60	85	7	10	12	14	0.3	85	9	13	0.3	8	12	0.3	8	12	0.3	8	12	0.3	8	12	0.3	8	12	0.3	8	12	0.3
13	65	90	8	10	13	15	0.3	90	9	13	0.3	8	12	0.3	8	12	0.3	8	12	0.3	8	12	0.3	8	12	0.3	8	12	0.3
14	70	90	8	10	13	15	0.3	100	10	16	0.3	8	12	0.3	8	12	0.3	8	12	0.3	8	12	0.3	8	12	0.3	8	12	0.3
15	75	95	8	10	13	15	0.3	105	10	16	0.3	8	12	0.3	8	12	0.3	8	12	0.3	8	12	0.3	8	12	0.3	8	12	0.3
16	80	100	8	10	13	15	0.3	110	10	16	0.3	8	12	0.3	8	12	0.3	8	12	0.3	8	12	0.3	8	12	0.3	8	12	0.3
17	85	110	9	13	16	19	0.3	120	11	18	0.3	8	12	0.3	8	12	0.3	8	12	0.3	8	12	0.3	8	12	0.3	8	12	0.3

F 1

Bore dia. No	Diameter series 7				Diameter series 8				Diameter series 9				Diameter series 0															
	Dimension series 17	Dimension series 27	Dimension series 37	r min.	Dimension series 08	Dimension series 18	Dimension series 28	Dimension series 38	Dimension series 48	Dimension series 58	Dimension series 68	Dimension series 09	Dimension series 19	Dimension series 29	Dimension series 39	Dimension series 49	Dimension series 59	Dimension series 69	Dimension series 00	Dimension series 10	Dimension series 20	Dimension series 30	Dimension series 40	Dimension series 50	Dimension series 60	Dimension series 10-60		
d	D	B	r	D	B	B	B	B	B	B	B	B	B	B	B	B	B	B	B	B	B	B	B	B	B	r min.		
18	90	115	9	13	16	19	25	34	45	0.3	1	125	11	18	22	26	35	46	63	0.6	1.1	1.1	1.1	1.1	1.1	1.1	1.1	1.1
19	95	120	9	13	16	19	25	34	45	0.3	1	130	11	18	22	26	35	46	63	0.6	1.1	1.1	1.1	1.1	1.1	1.1	1.1	1.1
20	100	125	9	13	16	19	25	34	45	0.3	1	140	13	20	24	30	40	54	63	0.6	1.1	1.1	1.1	1.1	1.1	1.1	1.1	1.1
21	105	130	9	13	16	19	25	34	45	0.3	1	145	13	20	24	30	40	54	71	0.6	1.1	1.1	1.1	1.1	1.1	1.1	1.1	1.1
22	110	140	10	16	19	23	30	40	54	0.6	1	150	13	20	24	30	40	54	71	0.6	1.1	1.1	1.1	1.1	1.1	1.1	1.1	1.1
24	120	150	10	16	19	23	30	40	54	0.6	1	165	14	22	27	34	45	60	80	0.6	1.1	1.1	1.1	1.1	1.1	1.1	1.1	1.1
26	130	165	11	18	22	26	35	46	63	0.6	1.1	180	16	24	30	37	50	67	90	1	1.5	1.5	1.5	1.5	1.5	1.5	1.5	1.5
28	140	175	11	18	22	26	35	46	63	0.6	1.1	190	16	24	30	37	50	67	90	1	1.5	1.5	1.5	1.5	1.5	1.5	1.5	1.5
30	150	190	13	20	24	30	40	54	71	0.6	1.1	210	19	28	36	45	60	80	109	1	2	2	2	2	2	2	2	2
32	160	200	13	20	24	30	40	54	71	0.6	1.1	220	19	28	36	45	60	80	109	1	2	2	2	2	2	2	2	2
34	170	215	14</																									

Supplementary table 4 Boundary dimensions of double direction thrust ball bearings

(with flat back faces)

Unit : mm

Bore dia. No.	522									523									524									Bore dia. No.
	Diameter series 2									Diameter series 3									Diameter series 4									
	Dimension series 22									Dimension series 23									Dimension series 24									
	Bore dia. d_2	Out-side dia. D	Height T_1	Central race height B	d_3 max.	D_1 min.	r min.	r_1 min.	(Refer.) $d^{1)}$	Bore dia. d_2	Out-side dia. D	Height T_1	Central race height B	d_3 max.	D_1 min.	r min.	r_1 min.	(Refer.) $d^{1)}$	Bore dia. d_2	Out-side dia. D	Height T_1	Central race height B	d_3 max.	D_1 min.	r min.	r_1 min.	(Refer.) $d^{1)}$	
02	10	32	22	5	32	17	0.6	0.3	15	10	—	—	—	—	—	—	—	—	—	—	—	—	—	—	—	—	02	
04	15	40	26	6	40	22	0.6	0.3	20	15	—	—	—	—	—	—	—	—	—	—	—	—	—	—	—	—	04	
05	20	47	28	7	47	27	0.6	0.3	25	20	52	34	8	52	27	1	0.3	25	15	60	45	11	60	27	1	0.6	25	05
06	25	52	29	7	52	32	0.6	0.3	30	25	60	38	9	60	32	1	0.3	30	20	70	52	12	70	32	1	0.6	30	06
07	30	62	34	8	62	37	1	0.3	35	30	68	44	10	68	37	1	0.3	35	25	80	59	14	80	37	1.1	0.6	35	07
08	30	68	36	9	68	42	1	0.6	40	30	78	49	12	78	42	1	0.6	40	30	90	65	15	90	42	1.1	0.6	40	08
09	35	73	37	9	73	47	1	0.6	45	35	85	52	12	85	47	1	0.6	45	35	100	72	17	100	47	1.1	0.6	45	09
10	40	78	39	9	78	52	1	0.6	50	40	95	58	14	95	52	1.1	0.6	50	40	110	78	18	110	52	1.5	0.6	50	10
11	45	90	45	10	90	57	1	0.6	55	45	105	64	15	105	57	1.1	0.6	55	45	120	87	20	120	57	1.5	0.6	55	11
12	50	95	46	10	95	62	1	0.6	60	50	110	64	15	110	62	1.1	0.6	60	50	130	93	21	130	62	1.5	0.6	60	12
13	55	100	47	10	100	67	1	0.6	65	55	115	65	15	115	67	1.1	0.6	65	55	140	101	23	140	68	2	1	65	13
14	55	105	47	10	105	72	1	1	70	55	125	72	16	125	72	1.1	1	70	55	150	107	24	150	73	2	1	70	14
15	60	110	47	10	110	77	1	1	75	60	135	79	18	135	77	1.5	1	75	60	160	115	26	160	78	2	1	75	15
16	65	115	48	10	115	82	1	1	80	65	140	79	18	140	82	1.5	1	80	65	170	120	27	170	83	2.1	1	80	16
17	70	125	55	12	125	88	1	1	85	70	150	87	19	150	88	1.5	1	85	65	180	128	29	179.5	88	2.1	1.1	85	17
18	75	135	62	14	135	93	1.1	1	90	75	155	88	19	155	93	1.5	1	90	75	190	135	30	189.5	93	2.1	1.1	90	18
20	85	150	67	15	150	103	1.1	1	100	85	170	97	21	170	103	1.5	1	100	85	210	150	33	209.5	103	3	1.1	100	20
22	95	160	67	15	160	113	1.1	1	110	95	190	110	24	189.5	113	2	1	110	95	230	166	37	229	113	3	1.1	110	22
24	100	170	68	15	170	123	1.1	1.1	120	100	210	123	27	209.5	123	2.1	1.1	120	100	250	177	40	249	123	4	1.5	120	24
26	110	190	80	18	189.5	133	1.5	1.1	130	110	225	130	30	224	134	2.1	1.1	130	110	270	192	42	269	134	4	2	130	26
28	120	200	81	18	199.5	143	1.5	1.1	140	120	240	140	31	239	144	2.1	1.1	140	110	280	196	44	279	144	4	2	140	28
30	130	215	89	20	214.5	153	1.5	1.1	150	130	250	140	31	249	154	2.1	1.1	150	120	300	209	46	299	154	4	2	150	30
32	140	225	90	20	224.5	163	1.5	1.1	160	140	270	153	33	269	164	3	1.1	160	130	320	226	50	319	164	5	2	160	32
34	150	240	97	21	239.5	173	1.5	1.1	170	150	280	153	33	279	174	3	1.1	170	135	340	236	50	339	174	5	2.1	170	34
36	150	250	98	21	249	183	1.5	2	180	150	300	165	37	299	184	3	2	180	140	360	245	52	359	184	5	3	180	36
38	160	270	109	24	269	194	2	2	190	160	320	183	40	319	195	4	2	190	—	—	—	—	—	—	—	—	—	38
40	170	280	109	24	279	204	2	2	200	170	340	192	42	339	205	4	2	200	—	—	—	—	—	—	—	—	—	40
44	190	300	110	24	299	224	2	2	220	—	—	—	—	—	—	—	—	—	—	—	—	—	—	—	—	—	—	44

[Note] 1) Nominal bore diameter of single direction bearings of the same diameter series and with the same nominal outside diameter.

Supplementary table 5 (1) Dimension of snap ring grooves and locating snap rings

– diameter series 18, 19 –

Unit : mm

Applicable bearing			Snap ring groove								Locating snap ring						Housing				
Bore dia. <i>d</i>	Outside dia. <i>D</i>	Snap ring groove dia. <i>D</i> ₁	Position of snap ring groove <i>a</i>				Snap ring groove width <i>b</i>		Fillet radius of snap ring groove <i>r</i> ₀	No.	Section height <i>e</i>		Thickness <i>f</i>		Mounted state		Shoulder bore dia. <i>D</i> _x				
			Dimension series 18		Dimension series 19		max.	min.			max.	min.	max.	min.	max.	min.		Distance between cut ends <i>g</i>	Locating snap ring O.D. <i>D</i> ₂		
18	19	max.	min.	max.	min.	max.	min.	max.		max.	min.	max.	min.	max.	max.						
–	10	22	20.8	20.5	–	–	1.05	0.9	1.05	0.8	0.2			NR 1022	2.0	1.85	0.7	0.6	2	24.8	25.5
–	12	24	22.8	22.5	–	–	1.05	0.9	1.05	0.8	0.2			NR 1024	2.0	1.85	0.7	0.6	2	26.8	27.5
–	15	28	26.7	26.4	–	–	1.3	1.15	1.2	0.95	0.25			NR 1028	2.05	1.9	0.85	0.75	3	30.8	31.5
–	17	30	28.7	28.4	–	–	1.3	1.15	1.2	0.95	0.25			NR 1030	2.05	1.9	0.85	0.75	3	32.8	33.5
20	–	32	30.7	30.4	1.3	1.15	–	–	1.2	0.95	0.25			NR 1032	2.05	1.9	0.85	0.75	3	34.8	35.5
22	–	34	32.7	32.4	1.3	1.15	–	–	1.2	0.95	0.25			NR 1034	2.05	1.9	0.85	0.75	3	36.8	37.5
25	20	37	35.7	35.4	1.3	1.15	1.7	1.55	1.2	0.95	0.25			NR 1037	2.05	1.9	0.85	0.75	3	39.8	40.5
–	22	39	37.7	37.4	–	–	1.7	1.55	1.2	0.95	0.25			NR 1039	2.05	1.9	0.85	0.75	3	41.8	42.5
28	–	40	38.7	38.4	1.3	1.15	–	–	1.2	0.95	0.25			NR 1040	2.05	1.9	0.85	0.75	3	42.8	43.5
30	25	42	40.7	40.4	1.3	1.15	1.7	1.55	1.2	0.95	0.25			NR 1042	2.05	1.9	0.85	0.75	3	44.8	45.5
32	–	44	42.7	42.4	1.3	1.15	–	–	1.2	0.95	0.25			NR 1044	2.05	1.9	0.85	0.75	4	46.8	47.5
–	28	45	43.7	43.4	–	–	1.7	1.55	1.2	0.95	0.25			NR 1045	2.05	1.9	0.85	0.75	4	47.8	48.5
35	30	47	45.7	45.4	1.3	1.15	1.7	1.55	1.2	0.95	0.25			NR 1047	2.05	1.9	0.85	0.75	4	49.8	50.5
40	32	52	50.7	50.4	1.3	1.15	1.7	1.55	1.2	0.95	0.25			NR 1052	2.05	1.9	0.85	0.75	4	54.8	55.5
–	35	55	53.7	53.4	–	–	1.7	1.55	1.2	0.95	0.25			NR 1055	2.05	1.9	0.85	0.75	4	57.8	58.5
45	–	58	56.7	56.4	1.3	1.15	–	–	1.2	0.95	0.25			NR 1058	2.05	1.9	0.85	0.75	4	60.8	61.5
–	40	62	60.7	60.3	–	–	1.7	1.55	1.2	0.95	0.25			NR 1062	2.05	1.9	0.85	0.75	4	64.8	65.5
50	–	65	63.7	63.3	1.3	1.15	–	–	1.2	0.95	0.25			NR 1065	2.05	1.9	0.85	0.75	4	67.8	68.5
–	45	68	66.7	66.3	–	–	1.7	1.55	1.2	0.95	0.25			NR 1068	2.05	1.9	0.85	0.75	5	70.8	72
55	50	72	70.7	70.3	1.7	1.55	1.7	1.55	1.2	0.95	0.25			NR 1072	2.05	1.9	0.85	0.75	5	74.8	76
60	–	78	76.2	75.8	1.7	1.55	–	–	1.6	1.3	0.4			NR 1078	3.25	3.1	1.12	1.02	5	82.7	84
–	55	80	77.9	77.5	–	–	2.1	1.9	1.6	1.3	0.4			NR 1080	3.25	3.1	1.12	1.02	5	84.4	86
65	60	85	82.9	82.5	1.7	1.55	2.1	1.9	1.6	1.3	0.4			NR 1085	3.25	3.1	1.12	1.02	5	89.4	91
70	65	90	87.9	87.5	1.7	1.55	2.1	1.9	1.6	1.3	0.4			NR 1090	3.25	3.1	1.12	1.02	5	94.4	96
75	–	95	92.9	92.5	1.7	1.55	–	–	1.6	1.3	0.4			NR 1095	3.25	3.1	1.12	1.02	5	99.4	101
80	70	100	97.9	97.5	1.7	1.55	2.5	2.3	1.6	1.3	0.4			NR 1100	3.25	3.1	1.12	1.02	5	104.4	106
–	75	105	102.6	102.1	–	–	2.5	2.3	1.6	1.3	0.4			NR 1105	4.04	3.89	1.12	1.02	5	110.7	112
85	80	110	107.6	107.1	2.1	1.9	2.5	2.3	1.6	1.3	0.4			NR 1110	4.04	3.89	1.12	1.02	5	115.7	117
90	–	115	112.6	112.1	2.1	1.9	–	–	1.6	1.3	0.4			NR 1115	4.04	3.89	1.12	1.02	5	120.7	122
95	85	120	117.6	117.1	2.1	1.9	3.3	3.1	1.6	1.3	0.4			NR 1120	4.04	3.89	1.12	1.02	7	125.7	127
100	90	125	122.6	122.1	2.1	1.9	3.3	3.1	1.6	1.3	0.4			NR 1125	4.04	3.89	1.12	1.02	7	130.7	132
105	95	130	127.6	127.1	2.1	1.9	3.3	3.1	1.6	1.3	0.4			NR 1130	4.04	3.89	1.12	1.02	7	135.7	137
110	100	140	137.6	137.1	2.5	2.3	3.3	3.1	2.2	1.9	0.6			NR 1140	4.04	3.89	1.7	1.6	7	145.7	147
–	105	145	142.6	142.1	–	–	3.3	3.1	2.2	1.9	0.6			NR 1145	4.04	3.89	1.7	1.6	7	150.7	152
120	110	150	147.6	147.1	2.5	2.3	3.3	3.1	2.2	1.9	0.6			NR 1150	4.04	3.89	1.7	1.6	7	155.7	157
130	120	165	161.8	161.3	3.3	3.1	3.7	3.5	2.2	1.9	0.6			NR 1165	4.85	4.7	1.7	1.6	7	171.5	173
140	–	175	171.8	171.3	3.3	3.1	–	–	2.2	1.9	0.6			NR 1175	4.85	4.7	1.7	1.6	10	181.5	183
–	130	180	176.8	176.3	–	–	3.7	3.5	2.2	1.9	0.6			NR 1180	4.85	4.7	1.7	1.6	10	186.5	188
150	140	190	186.8	186.3	3.3	3.1	3.7	3.5	2.2	1.9	0.6			NR 1190	4.85	4.7	1.7	1.6	10	196.5	198
160	–	200	196.8	196.3	3.3	3.1	–	–	2.2	1.9	0.6			NR 1200	4.85	4.7	1.7	1.6	10	206.5	208

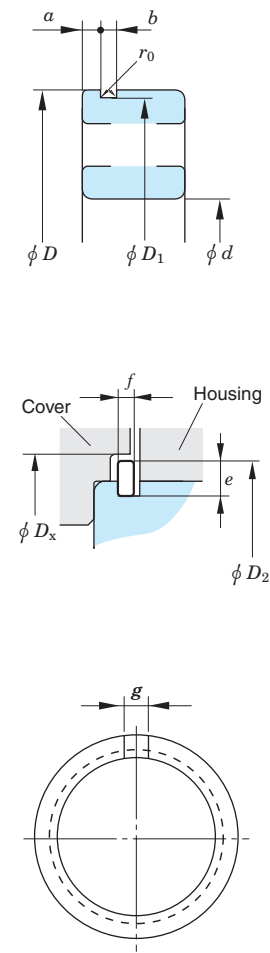

[Remark] Minimum chamfer dimension tolerances on snap ring groove-side outer ring are as follows :
 Bearings belonging to dimension series 18 : 0.3 mm for those with nominal outside diameter not more than 78 mm ; 0.5 mm for those with nominal diameter over 78 mm.
 Bearings belonging to dimension series 19 : 0.3 mm for those with nominal outside diameter not more than 47 mm ; 0.5 mm for those with nominal diameter over 47 mm.

Supplementary table 5 (2) Dimension of snap ring grooves and locating snap rings

- diameter series 0, 2, 3, 4 -

Unit : mm

Applicable bearing				Snap ring groove									Locating snap ring						Housing		
Bore dia. <i>d</i>				Outside dia. <i>D</i>	Snap ring groove dia. <i>D</i> ₁		Position of snap ring groove <i>a</i>				Snap ring groove width <i>b</i>		Fillet radius of snap ring groove <i>r</i> ₀	No.	Section height <i>e</i>		Thickness <i>f</i>		Mounted state		Shoulder bore dia. <i>D</i> _x
							Diameter series												max.	min.	
0	2	3	4	max.	min.	max.	min.	max.	min.	max.	max.	min.	max.	min.	max.	min.	max.	max.			
-	10	9	8	30	28.17	27.91	-	-	2.06	1.9	1.65	1.35	0.4	NR 30	3.25	3.1	1.12	1.02	3	34.7	35.5
15	12	-	9	32	30.15	29.9	2.06	1.9	2.06	1.9	1.65	1.35	0.4	NR 32	3.25	3.1	1.12	1.02	3	36.7	37.5
17	15	10	-	35	33.17	32.92	2.06	1.9	2.06	1.9	1.65	1.35	0.4	NR 35	3.25	3.1	1.12	1.02	3	39.7	40.5
-	-	12	10	37	34.77	34.52	-	-	2.06	1.9	1.65	1.35	0.4	NR 37	3.25	3.1	1.12	1.02	3	41.3	42
-	17	-	-	40	38.1	37.85	-	-	2.06	1.9	1.65	1.35	0.4	NR 40	3.25	3.1	1.12	1.02	3	44.6	45.5
20	-	15	12	42	39.75	39.5	2.06	1.9	2.06	1.9	1.65	1.35	0.4	NR 42	3.25	3.1	1.12	1.02	3	46.3	47
22	-	-	-	44	41.75	41.5	2.06	1.9	-	-	1.65	1.35	0.4	NR 44	3.25	3.1	1.12	1.02	3	48.3	49
25	20	17	-	47	44.6	44.35	2.06	1.9	2.46	2.31	1.65	1.35	0.4	NR 47	4.04	3.89	1.12	1.02	4	52.7	53.5
-	22	-	-	50	47.6	47.35	-	-	2.46	2.31	1.65	1.35	0.4	NR 50	4.04	3.89	1.12	1.02	4	55.7	56.5
28	25	20	15	52	49.73	49.48	2.06	1.9	2.46	2.31	1.65	1.35	0.4	NR 52	4.04	3.89	1.12	1.02	4	57.9	58.5
30	-	-	-	55	52.6	52.35	2.08	1.88	-	-	1.65	1.35	0.4	NR 55	4.04	3.89	1.12	1.02	4	60.7	61.5
-	-	22	-	56	53.6	53.35	-	-	2.46	2.31	1.65	1.35	0.4	NR 56	4.04	3.89	1.12	1.02	4	61.7	62.5
32	28	-	-	58	55.6	55.35	2.08	1.88	2.46	2.31	1.65	1.35	0.4	NR 58	4.04	3.89	1.12	1.02	4	63.7	64.5
35	30	25	17	62	59.61	59.11	2.08	1.88	3.28	3.07	2.2	1.9	0.6	NR 62	4.04	3.89	1.7	1.6	4	67.7	68.5
-	32	-	-	65	62.6	62.1	-	-	3.28	3.07	2.2	1.9	0.6	NR 65	4.04	3.89	1.7	1.6	4	70.7	71.5
40	-	28	-	68	64.82	64.31	2.49	2.29	3.28	3.07	2.2	1.9	0.6	NR 68	4.85	4.7	1.7	1.6	5	74.6	76
-	35	30	20	72	68.81	68.3	-	-	3.28	3.07	2.2	1.9	0.6	NR 72	4.85	4.7	1.7	1.6	5	78.6	80
45	-	32	-	75	71.83	71.32	2.49	2.29	3.28	3.07	2.2	1.9	0.6	NR 75	4.85	4.7	1.7	1.6	5	81.6	83
50	40	35	25	80	76.81	76.3	2.49	2.29	3.28	3.07	2.2	1.9	0.6	NR 80	4.85	4.7	1.7	1.6	5	86.6	88
-	45	-	-	85	81.81	81.31	-	-	3.28	3.07	2.2	1.9	0.6	NR 85	4.85	4.7	1.7	1.6	5	91.6	93
55	50	40	30	90	86.79	86.28	2.87	2.67	3.28	3.07	3	2.7	0.6	NR 90	4.85	4.7	2.46	2.36	5	96.5	98
60	-	-	-	95	91.82	91.31	2.87	2.67	-	-	3	2.7	0.6	NR 95	4.85	4.7	2.46	2.36	5	101.6	103
65	55	45	35	100	96.8	96.29	2.87	2.67	3.28	3.07	3	2.7	0.6	NR100	4.85	4.7	2.46	2.36	5	106.5	108
70	60	50	40	110	106.81	106.3	2.87	2.67	3.28	3.07	3	2.7	0.6	NR110	4.85	4.7	2.46	2.36	5	116.6	118
75	-	-	-	115	111.81	111.3	2.87	2.67	-	-	3	2.7	0.6	NR115	4.85	4.7	2.46	2.36	5	121.6	123
-	65	55	45	120	115.21	114.71	-	-	4.06	3.86	3.4	3.1	0.6	NR120	7.21	7.06	2.82	2.72	7	129.7	131.5
80	70	-	-	125	120.22	119.71	2.87	2.67	4.06	3.86	3.4	3.1	0.6	NR125	7.21	7.06	2.82	2.72	7	134.7	136.5
85	75	60	50	130	125.22	124.71	2.87	2.67	4.06	3.86	3.4	3.1	0.6	NR130	7.21	7.06	2.82	2.72	7	139.7	141.5
90	80	65	55	140	135.23	134.72	3.71	3.45	4.9	4.65	3.4	3.1	0.6	NR140	7.21	7.06	2.82	2.72	7	149.7	152
95	-	-	-	145	140.23	139.73	3.71	3.45	-	-	3.4	3.1	0.6	NR145	7.21	7.06	2.82	2.72	7	154.7	157
100	85	70	60	150	145.24	144.73	3.71	3.45	4.9	4.65	3.4	3.1	0.6	NR150	7.21	7.06	2.82	2.72	7	159.7	162
105	90	75	65	160	155.22	154.71	3.71	3.45	4.9	4.65	3.4	3.1	0.6	NR160	7.21	7.06	2.82	2.72	7	169.7	172
110	95	80	-	170	163.65	163.14	3.71	3.45	5.69	5.44	3.8	3.5	0.6	NR170	9.6	9.45	3.1	3	10	182.9	185
120	100	85	70	180	173.66	173.15	3.71	3.45	5.69	5.44	3.8	3.5	0.6	NR180	9.6	9.45	3.1	3	10	192.9	195
-	105	90	75	190	183.64	183.13	-	-	5.69	5.44	3.8	3.5	0.6	NR190	9.6	9.45	3.1	3	10	202.9	205
130	110	95	80	200	193.65	193.14	5.69	5.44	5.69	5.44	3.8	3.5	0.6	NR200	9.6	9.45	3.1	3	10	212.9	215

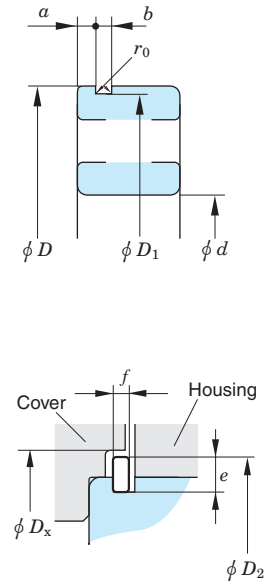

[Remark] 1. Snap ring groove dimension does not apply to bearings of dimension series 00, 82 and 83.
 2. The minimum permissible chamfer dimension for snap ring groove-side outer ring is 0.5 mm, except 0.3 mm for bearings belonging to diameter series 0 with nominal outside diameter not more than 35 mm.

Supplementary table 6 Shaft tolerances (deviation from nominal dimensions)

Unit : μm (Refer.)

Nominal shaft dia. (mm)		Deviation classes of shaft dia.																				Nominal shaft dia. (mm)		$\Delta_{dmp}^{(1)}$ of bearing (class 0)							
over	up to	d 6	e 6	f 6	g 5	g 6	h 5	h 6	h 7	h 8	h 9	h 10	js 5	js 6	js 7	j 5	j 6	k 5	k 6	k 7	m 5	m 6	m 7		n 5	n 6	p 6	r 6	r 7	over	up to
3	6	-30 -38	-20 -28	-10 -18	-4 -9	-4 -12	-0 -5	-0 -8	0 -12	0 -18	0 -30	0 -48	± 2.5	± 4	± 6	+3 -2	+6 -2	+6 +1	+9 +1	+13 +1	+9 +4	+12 +4	+16 +4	+13 +8	+16 +8	+20 +12	+23 +15	+27 +15	3	6	0 -8
6	10	-40 -49	-25 -34	-13 -22	-5 -11	-5 -14	-0 -6	-0 -9	0 -15	0 -22	0 -36	0 -58	± 3	± 4.5	± 7.5	+4 -2	+7 -2	+7 +1	+10 +1	+16 +1	+12 +6	+15 +6	+21 +6	+16 +10	+19 +10	+24 +15	+28 +19	+34 +19	6	10	0 -8
10	18	-50 -61	-32 -43	-16 -27	-6 -14	-6 -17	-0 -8	0 -11	0 -18	0 -27	0 -43	0 -70	± 4	± 5.5	± 9	+5 -3	+8 -3	+9 +1	+12 +1	+19 +1	+15 +7	+18 +7	+25 +9	+20 +12	+23 +12	+29 +18	+34 +23	+41 +23	10	18	0 -8
18	30	-65 -78	-40 -53	-20 -33	-7 -16	-7 -20	-0 -9	0 -13	0 -21	0 -33	0 -52	0 -84	± 4.5	± 6.5	± 10.5	+5 -4	+9 -4	+11 +2	+15 +2	+23 +2	+17 +8	+21 +8	+29 +8	+24 +15	+28 +15	+35 +22	+41 +28	+49 +28	18	30	0 -10
30	50	-80 -96	-50 -66	-25 -41	-9 -20	-9 -25	0 -11	0 -16	0 -25	0 -39	0 -62	0 -100	± 5.5	± 8	± 12.5	+6 -5	+11 -5	+12 +2	+18 +2	+27 +2	+20 +9	+25 +9	+34 +9	+28 +17	+33 +17	+42 +26	+50 +34	+59 +34	30	50	0 -12
50	80	-100 -119	-60 -79	-30 -49	-10 -23	-10 -29	0 -13	0 -19	0 -30	0 -46	0 -74	0 -120	± 6.5	± 9.5	± 15	+6 -7	+12 -7	+15 +2	+21 +2	+32 +2	+24 +11	+30 +11	+41 +11	+33 +20	+39 +20	+51 +32	+60 +41	+71 +41	50	80	0 -15
80	120	-120 -142	-72 -94	-36 -58	-12 -27	-12 -34	0 -15	0 -22	0 -35	0 -54	0 -87	0 -140	± 7.5	± 11	± 17.5	+6 -9	+13 -9	+18 +3	+25 +3	+38 +3	+28 +13	+35 +13	+48 +13	+38 +23	+45 +23	+59 +37	+73 +51	+86 +51	80	120	0 -20
120	180	-145 -170	-85 -110	-43 -68	-14 -32	-14 -39	0 -18	0 -25	0 -40	0 -63	0 -100	0 -160	± 9	± 12.5	± 20	+7 -11	+14 -11	+21 +3	+28 +3	+43 +3	+33 +15	+40 +15	+55 +15	+45 +27	+52 +27	+68 +43	+88 +63	+103 +63	120	180	0 -25
180	250	-170 -199	-100 -129	-50 -79	-15 -35	-15 -44	0 -20	0 -29	0 -46	0 -72	0 -115	0 -185	± 10	± 14.5	± 23	+7 -13	+16 -13	+24 +4	+33 +4	+50 +4	+37 +17	+46 +17	+63 +17	+51 +31	+60 +31	+79 +50	+106 +77	+123 +77	180	250	0 -30
250	315	-190 -222	-110 -142	-56 -88	-17 -40	-17 -49	0 -23	0 -32	0 -52	0 -81	0 -130	0 -210	± 11.5	± 16	± 26	+7 -16	+16 -16	+27 +4	+36 +4	+56 +4	+43 +20	+52 +20	+72 +20	+57 +34	+66 +34	+88 +56	+126 +94	+146 +94	250	315	0 -35
315	400	-210 -246	-125 -161	-62 -98	-18 -43	-18 -54	0 -25	0 -36	0 -57	0 -89	0 -140	0 -230	± 12.5	± 18	± 28.5	+7 -18	+18 -18	+29 +4	+40 +4	+61 +4	+46 +21	+57 +21	+78 +21	+62 +37	+73 +37	+98 +62	+144 +108	+165 +108	315	400	0 -40
400	500	-230 -270	-135 -175	-68 -108	-20 -47	-20 -60	0 -27	0 -40	0 -63	0 -97	0 -155	0 -250	± 13.5	± 20	± 31.5	+7 -20	+20 -20	+32 +5	+45 +5	+68 +5	+50 +23	+63 +23	+86 +23	+67 +40	+80 +40	+108 +68	+166 +126	+189 +126	400	500	0 -45
500	630	-260 -304	-145 -189	-76 -120	-22 -54	-22 -66	0 -32	0 -44	0 -70	0 -110	0 -175	0 -280	± 16	± 22	± 35	-	-	+32 0	+44 0	+70 0	+58 +26	+70 +26	+96 +26	+76 +44	+88 +44	+122 +78	+194 +150	+220 +150	500	630	0 -50
630	800	-290 -340	-160 -210	-80 -130	-24 -60	-24 -74	0 -36	0 -50	0 -80	0 -125	0 -200	0 -320	± 18	± 25	± 40	-	-	+36 0	+50 0	+80 0	+66 +30	+80 +30	+110 +30	+86 +50	+100 +50	+138 +88	+225 +175	+255 +175	630	800	0 -75
800	1000	-320 -376	-170 -226	-86 -142	-26 -66	-26 -82	0 -40	0 -56	0 -90	0 -140	0 -230	0 -360	± 20	± 28	± 45	-	-	+40 0	+56 0	+90 0	+74 +34	+90 +34	+124 +34	+96 +56	+112 +56	+156 +100	+266 +210	+300 +210	800	1000	0 -100

[Note] 1) Δ_{dmp} : single plane mean bore diameter deviation

Supplementary table 7 Housing bore tolerances (deviation from nominal dimensions)

Unit : μm (Refer.)

Nominal Bore dia. (mm)		Deviation classes of housing bore																				Nominal Bore dia. (mm)		$\Delta D_{mp}^{(1)}$ of bearing (class 0)							
over	up to	E 6	F 6	F 7	G 6	G 7	H 6	H 7	H 8	H 9	H 10	JS 5	JS 6	JS 7	J 6	J 7	K 5	K 6	K 7	M 5	M 6	M 7	N 5		N 6	N 7	P 6	P 7	R 7	over	up to
10	18	+43 +32	+27 +16	+34 +16	+17 +6	+24 +6	+11 0	+18 0	+27 0	+43 0	+70 0	± 4	± 5.5	± 9	+6 -5	+10 -8	+2 -6	+2 -9	+6 -12	-4 -12	-4 -15	0 -18	-9 -17	-9 -20	-5 -23	-15 -26	-11 -29	-16 -34	10	18	0 -8
18	30	+53 +40	+33 +20	+41 +20	+20 +7	+28 +7	+13 0	+21 0	+33 0	+52 0	+84 0	± 4.5	± 6.5	± 10.5	+8 -5	+12 -9	+1 -8	+2 -11	+6 -15	-5 -14	-4 -17	0 -21	-12 -21	-11 -24	-7 -28	-18 -31	-14 -35	-20 -41	18	30	0 -9
30	50	+66 +50	+41 +25	+50 +25	+25 +9	+34 +9	+16 0	+25 0	+39 0	+62 0	+100 0	± 5.5	± 8	± 12.5	+10 -6	+14 -11	+2 -9	+3 -13	+7 -18	-5 -16	-4 -20	0 -25	-13 -24	-12 -28	-8 -33	-21 -37	-17 -42	-25 -50	30	50	0 -11
50	80	+79 +60	+49 +30	+60 +30	+29 +10	+40 +10	+19 0	+30 0	+46 0	+74 0	+120 0	± 6.5	± 9.5	± 15	+13 -6	+18 -12	+3 -10	+4 -15	+9 -21	-6 -19	-5 -24	0 -30	-15 -28	-14 -33	-9 -39	-26 -45	-21 -51	-30 -60	50	65	0 -13
		+65 +50	+35 +20	+45 +20	+25 +9	+35 +9	+15 0	+25 0	+35 0	+65 0	+120 0	+100 0	± 6.5	± 9.5	± 15	+13 -6	+18 -12	+3 -10	+4 -15	+9 -21	-6 -19	-5 -24	0 -30	-15 -28	-14 -33	-9 -39	-26 -45	-21 -51	-32 -62	65	80
80	120	+94 +72	+58 +36	+71 +36	+34 +12	+47 +12	+22 0	+35 0	+54 0	+87 0	+140 0	± 7.5	± 11	± 17.5	+16 -6	+22 -13	+2 -13	+4 -18	+10 -25	-8 -23	-6 -28	0 -35	-18 -33	-16 -38	-10 -45	-30 -52	-24 -59	-38 -73	80	100	0 -15
		+76 +60	+40 +25	+50 +25	+25 +9	+35 +9	+15 0	+25 0	+35 0	+65 0	+120 0	+100 0	± 7.5	± 11	± 17.5	+16 -6	+22 -13	+2 -13	+4 -18	+10 -25	-8 -23	-6 -28	0 -35	-18 -33	-16 -38	-10 -45	-30 -52	-24 -59	-41 -76	100	120
120	180	+110 +85	+68 +43	+83 +43	+39 +14	+54 +14	+25 0	+40 0	+63 0	+100 0	+160 0	± 9	± 12.5	± 20	+18 -7	+26 -14	+3 -15	+4 -21	+12 -28	-9 -27	-8 -33	0 -40	-21 -39	-20 -45	-12 -52	-36 -61	-28 -68	-48 -88	120	140	(up to 150) 0
		+140 +100	+70 +45	+90 +45	+39 +14	+54 +14	+25 0	+40 0	+63 0	+100 0	+160 0	+160 0	± 9	± 12.5	± 20	+18 -7	+26 -14	+3 -15	+4 -21	+12 -28	-9 -27	-8 -33	0 -40	-21 -39	-20 -45	-12 -52	-36 -61	-28 -68	-50 -90	140	160
180	250	+129 +100	+79 +50	+96 +50	+44 +15	+61 +15	+29 0	+46 0	+72 0	+115 0	+185 0	± 10	± 14.5	± 23	+22 -7	+30 -16	+2 -18	+5 -24	+13 -33	-11 -31	-8 -37	0 -46	-25 -45	-22 -51	-14 -60	-41 -70	-33 -79	-60 -106	180	200	0 -30
		+160 +120	+60 +35	+70 +35	+44 +15	+61 +15	+29 0	+46 0	+72 0	+115 0	+185 0	+185 0	± 10	± 14.5	± 23	+22 -7	+30 -16	+2 -18	+5 -24	+13 -33	-11 -31	-8 -37	0 -46	-25 -45	-22 -51	-14 -60	-41 -70	-33 -79	-63 -109	200	225
250	315	+142 +110	+88 +56	+108 +56	+49 +17	+69 +17	+32 0	+52 0	+81 0	+130 0	+210 0	± 11.5	± 16	± 26	+25 -7	+36 -16	+3 -20	+5 -27	+16 -36	-13 -36	-9 -41	0 -52	-27 -50	-25 -57	-14 -66	-47 -79	-36 -88	-74 -126	250	280	0 -35
		+170 +130	+60 +35	+70 +35	+49 +17	+69 +17	+32 0	+52 0	+81 0	+130 0	+210 0	+210 0	± 11.5	± 16	± 26	+25 -7	+36 -16	+3 -20	+5 -27	+16 -36	-13 -36	-9 -41	0 -52	-27 -50	-25 -57	-14 -66	-47 -79	-36 -88	-67 -113	225	250
315	400	+161 +125	+98 +62	+119 +62	+54 +18	+75 +18	+36 0	+57 0	+89 0	+140 0	+230 0	± 12.5	± 18	± 28.5	+29 -7	+39 -18	+3 -22	+7 -29	+17 -40	-14 -39	-10 -46	0 -57	-30 -55	-26 -62	-16 -73	-51 -87	-41 -98	-87 -144	315	355	0 -40
		+190 +150	+70 +45	+80 +45	+54 +18	+75 +18	+36 0	+57 0	+89 0	+140 0	+230 0	+230 0	± 12.5	± 18	± 28.5	+29 -7	+39 -18	+3 -22	+7 -29	+17 -40	-14 -39	-10 -46	0 -57	-30 -55	-26 -62	-16 -73	-51 -87	-41 -98	-93 -150	355	400
400	500	+175 +135	+108 +68	+131 +68	+60 +20	+83 +20	+40 0	+63 0	+97 0	+155 0	+250 0	± 13.5	± 20	± 31.5	+33 -7	+43 -20	+2 -25	+8 -32	+18 -45	-16 -43	-10 -50	0 -63	-33 -60	-27 -67	-17 -80	-55 -95	-45 -108	-103 -172	400	450	0 -45
		+200 +160	+80 +55	+91 +55	+60 +20	+83 +20	+40 0	+63 0	+97 0	+155 0	+250 0	+250 0	± 13.5	± 20	± 31.5	+33 -7	+43 -20	+2 -25	+8 -32	+18 -45	-16 -43	-10 -50	0 -63	-33 -60	-27 -67	-17 -80	-55 -95	-45 -108	-109 -172	450	500
500	630	+189 +145	+120 +76	+146 +76	+66 +22	+92 +22	+44 0	+70 0	+110 0	+175 0	+280 0	± 16	± 22	± 35	-	-	0 -32	0 -44	0 -70	-26 -58	-26 -70	-26 -96	-44 -76	-44 -88	-44 -114	-78 -122	-78 -148	-150 -220	500	560	0 -50
		+210 +170	+90 +65	+101 +65	+66 +22	+92 +22	+44 0	+70 0	+110 0	+175 0	+280 0	+280 0	± 16	± 22	± 35	-	-	0 -32	0 -44	0 -70	-26 -58	-26 -70	-26 -96	-44 -76	-44 -88	-44 -114	-78 -122	-78 -148	-155 -225	560	630
630	800	+210 +160	+130 +80	+160 +80	+74 +24	+104 +24	+50 0	+80 0	+125 0	+200 0	+320 0	± 18	± 25	± 40	-	-	0 -36	0 -50	0 -80	-30 -66	-30 -80	-30 -110	-50 -86	-50 -100	-50 -130	-88 -138	-88 -168	-175 -255	630	710	0 -75
		+240 +200	+100 +75	+111 +75	+74 +24	+104 +24	+50 0	+80 0	+125 0	+200 0	+320 0	+320 0	± 18	± 25	± 40	-	-	0 -36	0 -50	0 -80	-30 -66	-30 -80	-30 -110	-50 -86	-50 -100	-50 -130	-88 -138	-88 -168	-185 -265	710	800
800	1000	+226 +170	+142 +86	+176 +86	+82 +26	+116 +26	+56 0	+90 0	+140 0	+230 0	+360 0	± 20	± 28	± 45	-	-	0 -40	0 -56	0 -90	-34 -74	-34 -90	-34 -124	-56 -96	-56 -112	-56 -146	-100 -156	-100 -190	-210 -300	800	900	0 -100
		+260 +220	+110 +85	+121 +85	+82 +26	+116 +26	+56 0	+90 0	+140 0	+230 0	+360 0	+360 0	± 20	± 28	± 45	-	-	0 -40	0 -56	0 -90	-34 -74	-34 -90	-34 -124	-56 -96	-56 -112	-56 -146	-100 -156	-100 -190	-220 -310	900	1000
1000	1250	+261 +195	+164 +98	+203 +98	+94 +28	+133 +28	+66 0	+105 0	+165 0	+260 0	+420 0	± 23.5	± 33	± 52.5	-	-	0 -47	0 -66	0 -105	-40 -87	-40 -106	-40 -145	-66 -113	-66 -132	-66 -171	-120 -186	-120 -225	-250 -355	1000	1120	0 -125
		+290 +250	+130 +105	+141 +105	+94 +28	+133 +28	+66 0	+105 0	+165 0	+260 0	+420 0	+420 0	± 23.5	± 33	± 52.5	-	-	0 -47	0 -66	0 -105	-40 -87	-40 -106	-40 -145	-66 -113	-66 -132	-66 -171	-120 -186	-120 -225	-260 -365	1120	1250

[Note] 1) ΔD_{mp} : single plane mean outside diameter deviation

Supplementary table 8 Numerical values for standard tolerance grades IT (ISO 286-1 : 1988)

Basic size (mm)		Standard tolerance grades (IT)																	
		1	2	3	4	5	6	7	8	9	10	11	12	13	14 ¹⁾	15 ¹⁾	16 ¹⁾	17 ¹⁾	18 ¹⁾
over	up to	Tolerances (μm)									Tolerances (mm)								
–	3	0.8	1.2	2	3	4	6	10	14	25	40	60	0.10	0.14	0.26	0.40	0.60	1.00	1.40
3	6	1	1.5	2.5	4	5	8	12	18	30	48	75	0.12	0.18	0.30	0.48	0.75	1.20	1.80
6	10	1	1.5	2.5	4	6	9	15	22	36	58	90	0.15	0.22	0.36	0.58	0.90	1.50	2.20
10	18	1.2	2	3	5	8	11	18	27	43	70	110	0.18	0.27	0.43	0.70	1.10	1.80	2.70
18	30	1.5	2.5	4	6	9	13	21	33	52	84	130	0.21	0.33	0.52	0.84	1.30	2.10	3.30
30	50	1.5	2.5	4	7	11	16	25	39	62	100	160	0.25	0.39	0.62	1.00	1.60	2.50	3.90
50	80	2	3	5	8	13	19	30	46	74	120	190	0.30	0.46	0.74	1.20	1.90	3.00	4.60
80	120	2.5	4	6	10	15	22	35	54	87	140	220	0.35	0.54	0.87	1.40	2.20	3.50	5.40
120	180	3.5	5	8	12	18	25	40	63	100	160	250	0.40	0.63	1.00	1.60	2.50	4.00	6.30
180	250	4.5	7	10	14	20	29	46	72	115	185	290	0.46	0.72	1.15	1.85	2.90	4.60	7.20
250	315	6	8	12	16	23	32	52	81	130	210	320	0.52	0.81	1.30	2.10	3.20	5.20	8.10
315	400	7	9	13	18	25	36	57	89	140	230	360	0.57	0.89	1.40	2.30	3.60	5.70	8.90
400	500	8	10	15	20	27	40	63	97	155	250	400	0.63	0.97	1.55	2.50	4.00	6.30	9.70
500	630	–	–	–	–	–	44	70	110	175	280	440	0.70	1.10	1.75	2.80	4.40	7.00	11.00
630	800	–	–	–	–	–	50	80	125	200	320	500	0.80	1.25	2.00	3.20	5.00	8.00	12.50
800	1000	–	–	–	–	–	56	90	140	230	360	560	0.90	1.40	2.30	3.60	5.60	9.00	14.00
1000	1250	–	–	–	–	–	66	105	165	260	420	660	1.05	1.65	2.60	4.20	6.60	10.50	16.50
1250	1600	–	–	–	–	–	78	125	195	310	500	780	1.25	1.95	3.10	5.00	7.80	12.50	19.50
1600	2000	–	–	–	–	–	92	150	230	370	600	920	1.50	2.30	3.70	6.00	9.20	15.00	23.00
2000	2500	–	–	–	–	–	110	175	280	440	700	1100	1.75	2.80	4.40	7.00	11.00	17.50	28.00
2500	3150	–	–	–	–	–	135	210	330	540	860	1350	2.10	3.30	5.40	8.60	13.50	21.00	33.00

[Note] 1) Standard tolerance grades IT 14 to IT 18 (incl.) shall not be used for basic sizes less than or equal to 1 mm.

Supplementary table 9 Greek alphabet list

Name	Roman type		Italic type		Name	Roman type		Italic type	
	Capital		Capital	Lowercase		Capital	Capital	Lowercase	
alpha	A		<i>A</i>	<i>α</i>	nu	N	<i>N</i>	<i>ν</i>	
beta	B		<i>B</i>	<i>β</i>	xi	Ξ	<i>Ξ</i>	<i>ξ</i>	
gamma	Γ		<i>Γ</i>	<i>γ</i>	omicron	O	<i>O</i>	<i>ο</i>	
delta	Δ		<i>Δ</i>	<i>δ</i>	pi	Π	<i>Π</i>	<i>π</i>	
epsilon	E		<i>E</i>	<i>ε</i>	rho	Ρ	<i>Ρ</i>	<i>ρ</i>	
zeta	Z		<i>Z</i>	<i>ζ</i>	sigma	Σ	<i>Σ</i>	<i>σ</i>	
eta	H		<i>H</i>	<i>η</i>	tau	T	<i>T</i>	<i>τ</i>	
theta	Θ		<i>Θ</i>	<i>θ</i>	upsilon	Υ	<i>Υ</i>	<i>υ</i>	
iota	I		<i>I</i>	<i>ι</i>	phi	Φ	<i>Φ</i>	<i>φ</i>	
kappa	K		<i>K</i>	<i>κ</i>	chi	X	<i>X</i>	<i>χ</i>	
lambda	Λ		<i>Λ</i>	<i>λ</i>	psi	Ψ	<i>Ψ</i>	<i>ψ</i>	
mu	M		<i>M</i>	<i>μ</i>	omega	Ω	<i>Ω</i>	<i>ω</i>	

Supplementary table 10 Prefixes used with SI units

Factor	Prefix		Factor	Prefix	
	Name	Symbol		Name	Symbol
10 ¹⁸	exa	E	10 ⁻¹	deci	d
10 ¹⁵	peta	P	10 ⁻²	centi	c
10 ¹²	tera	T	10 ⁻³	milli	m
10 ⁹	giga	G	10 ⁻⁶	micro	μ
10 ⁶	mega	M	10 ⁻⁹	nano	n
10 ³	kilo	k	10 ⁻¹²	pico	p
10 ²	hecto	h	10 ⁻¹⁵	femto	f
10	deka	da	10 ⁻¹⁸	atto	a

Supplementary table 11 (1) SI units and conversion factors

Mass	SI units	Other units ¹⁾	Conversion into SI units	Conversion from SI units
Angle	rad [radian(s)]	° [degree(s)] ' [minute(s)] " [second(s)]	* 1° = π/180 rad * 1' = π/10 800 rad * 1" = π/648 000 rad	1 rad = 57.295 78°
Length	m [meter(s)]	Å [Angstrom unit] μ [micron(s)] in [inch(es)] ft [foot(feet)] yd [yard(s)] mile [mile(s)]	1Å = 10 ⁻¹⁰ m = 0.1nm = 100pm 1μ = 1 μm 1in = 25.4 mm 1ft = 12 in = 0.304 8 m 1yd = 3 ft = 0.914 4 m 1mile = 5 280 ft = 1 609.344 m	1m = 10 ¹⁰ Å 1m = 39.37 in 1m = 3.280 8 ft 1m = 1.093 6 yd 1km = 0.621 4 mile
Area	m ²	a [are(s)] ha [hectare(s)] acre [acre(s)]	1a = 100 m ² 1ha = 10 ⁴ m ² 1acre = 4 840 yd ² = 4 046.86 m ²	1km ² = 247.1 acre
Volume	m ³	ℓ, L [liter(s)] cc [cubic centimeters] gal(US) [gallon(s)] floz(US) [fluid ounce(s)] barrel(US) [barrels(US)]	* 1ℓ = 1 dm ³ = 10 ⁻³ m ³ * 1cc = 1 cm ³ = 10 ⁻⁶ m ³ 1gal(US) = 231 in ³ = 3.785 41dm ³ 1floz(US) = 29.573 5 cm ³ 1barrel(US) = 158.987 dm ³	1m ³ = 10 ³ ℓ 1m ³ = 10 ⁶ cc 1m ³ = 264.17 gal 1m ³ = 33 814 floz 1m ³ = 6.289 8 barrel
Time	s [second(s)]	min [minute(s)] h [hour(s)] d [day(s)]	* * *	
Angular velocity	rad/s			
Velocity	m/s	kn [knot(s)] m/h	* *	1kn = 1 852 m/h 1km/h = 0.539 96 kn
Acceleration	m/s ²	G		1G = 9.806 65 m/s ² 1m/s ² = 0.101 97 G
Frequency	Hz [hertz]	c/s [cycle(s)/second]		1c/s = 1s ⁻¹ = 1 Hz
Rotational frequency	s ⁻¹	rpm [revolutions per minute] min ⁻¹ r/min	* *	1rpm = 1 / 60 s ⁻¹ 1s ⁻¹ = 60 rpm
Mass	kg [kilogram(s)]	t [ton(s)] lb [pound(s)] gr [grain(s)] oz [ounce(s)] ton (UK) [ton(s)(UK)] ton (US) [ton(s)(US)] car [carat(s)]	* * * * * * *	1t = 10 ³ kg 1lb = 0.453 592 37 kg 1gr = 64.798 91 mg 1oz = 1/16 lb = 28.349 5 g 1ton(UK) = 1 016.05 kg 1ton(US) = 907.185 kg 1car = 200 mg 1kg = 2.204 6 lb 1g = 15.432 4 gr 1kg = 35.274 0 oz 1t = 0.984 2 ton(UK) 1t = 1.102 3 ton(US) 1g = 5 car

[Note] * : Unit can be used as an SI unit.
No asterisk : Unit cannot be used.

Supplementary table 11 (2) SI units and conversion factors

Mass	SI units	Other units ¹⁾	Conversion into SI units	Conversion from SI units
Density	kg/m ³			
Linear density	kg/m			
Momentum	kg·m/s			
Moment of momentum, angular momentum	kg·m ² /s			
Moment of inertia		kg·m ²		
Force	N [newton(s)]	dyn [dyne(s)] kgf [kilogram-force] gf [gram-force] tf [ton-force] lbf [pound-force]	1dyn = 10 ⁻⁵ N 1kgf = 9.806 65 N 1gf = 9.806 65×10 ⁻³ N 1tf = 9.806 65×10 ³ N 1lbf = 4.448 22 N	1N = 10 ⁵ dyn 1N = 0.101 97 kgf 1N = 0.224 809 lbf
Moment of force	N·m [Newton meter(s)]	gf·cm kgf·cm kgf·m tf·m lbf·ft	1gf·cm = 9.806 65×10 ⁻⁵ N·m 1kgf·cm = 9.806 65×10 ⁻² N·m 1kgf·m = 9.806 65 N·m 1tf·m = 9.806 65×10 ³ N·m 1lbf·ft = 1.355 82 N·m	1N·m = 0.101 97 kgf·m 1N·m = 0.737 56 lbf·ft
Pressure, Normal stress	Pa [Pascal(s)] or N/m ² { 1 Pa = 1 N/m ² }	gf/cm ² kgf/mm ² kgf/m ² lbf/in ² bar [bar(s)] at [engineering air pressure] mH ₂ O, mAq [meter water column] atm [atmosphere] mHg [meter mercury column] Torr [torr]	1gf/cm ² = 9.806 65×10 Pa 1kgf/mm ² = 9.806 65×10 ⁶ Pa 1kgf/m ² = 9.806 65 Pa 1lbf/in ² = 6 894.76 Pa 1bar = 10 ⁵ Pa 1at = 1kgf/cm ² = 9.806 65×10 ⁴ Pa 1mH ₂ O = 9.806 65×10 ³ Pa 1atm = 101 325 Pa 1mHg = $\frac{101\ 325}{0.76}$ Pa 1Torr = 1 mmHg = 133.322 Pa	1MPa = 0.101 97 kgf/mm ² 1Pa = 0.101 97 kgf/m ² 1Pa = 0.145×10 ⁻⁵ lbf/in ² 1Pa = 10 ⁻² mbar 1Pa = 7.500 6×10 ⁻³ Torr
Viscosity	Pa·s [pascal second]	P [poise] kgf·s/m ²	10 ⁻² P = 1 cP = 1 mPa·s 1kgf·s/m ² = 9.806 65 Pa·s	1Pa·s = 0.101 97 kgf·s/m ²
Kinematic viscosity	m ² /s	St [stokes]	10 ⁻² St = 1 cSt = 1 mm ² /s	
Surface tension	N/m			

Supplementary table 11 (3) SI units and conversion factors

Mass	SI units	Other units ¹⁾	Conversion into SI units	Conversion from SI units
Work, energy	J [joule(s)] {1 J=1 N·m}	eV [electron volt(s)] * erg [erg(s)] kgf·m lbf·ft	1eV = (1.602 189 2± 0.000 004 6)×10 ⁻¹⁹ J 1 erg = 10 ⁻⁷ J 1 kgf·m = 9.806 65 J 1 lbf·ft = 1.355 82 J	1 J = 10 ⁷ erg 1 J = 0.101 97 kgf·m 1 J = 0.737 56 lbf·ft
Power	W [watt(s)]	erg/s [ergs per second] kgf·m/s PS [French horse-power] HP [horse-power (British)] lbf·ft/s	1 erg/s = 10 ⁻⁷ W 1 kgf·m/s = 9.806 65 W 1 PS = 75 kgf·m/s = 735.5 W 1 HP = 550 lbf·ft/s = 745.7 W 1 lbf·ft/s = 1.355 82 W	1 W = 0.101 97 kgf·m/s 1 W = 0.001 36 PS 1 W = 0.001 34 HP
Thermo-dynamic temperature	K [kelvin(s)]			
Celsius temperature	°C [Celsius(s)] {t°C = (t+273.15)K}	°F [degree(s) Fahrenheit]	t °F = $\frac{5}{9}(t-32)°C$	t °C = $(\frac{9}{5}t+32)°F$
Linear expansion coefficient	K ⁻¹	°C ⁻¹ [per degree]		
Heat	J [joule(s)] {1 J=1 N·m}	erg [erg(s)] kgf·m cal _{IT} [I. T. calories]	1 erg = 10 ⁻⁷ J 1 cal _{IT} = 4.186 8 J 1 Mcal _{IT} = 1.163 kW·h	1 J = 10 ⁷ erg 1 J = 0.238 85 cal _{IT} 1 kW·h = 0.86 × 10 ⁶ cal _{IT}
Thermal conductivity	W/(m·K)	W/(m·°C) cal/(s·m·°C)	1 W/(m·°C) = 1 W/(m·K) 1 cal/(s·m·°C) = 4.186 05 W/(m·K)	
Coefficient of heat transfer	W/(m ² ·K)	W/(m ² ·°C) cal/(s·m ² ·°C)	1 W/(m ² ·°C) = 1 W/(m ² ·K) 1 cal/(s·m ² ·°C) = 4.186 05 W/(m ² ·K)	
Heat capacity	J/K	J/°C	1 J/°C = 1 J/K	
Massic heat capacity	J/(kg·K)	J/(kg·°C)		

[Note] * : Unit can be used as an SI unit.
No asterisk : Unit cannot be used.

Supplementary table 11 (4) SI units and conversion factors

Mass	SI units	Other units ¹⁾	Conversion into SI units	Conversion from SI units
Electric current	A [ampere(s)]			
Electric charge, quantity of electricity	C [coulomb(s)] {1 C = 1 A·s}	A·h *	1 A·h = 3.6 kC	
Tension, electric potential	V [volt(s)] {1 V = 1 W/A}			
Capacitance	F [farad(s)] {1 F = 1 C/V}			
Magnetic field strength	A/m	Oe [oersted(s)]	1 Oe = $\frac{10^3}{4\pi}$ A/m	1 A/m = 4π × 10 ⁻³ Oe
Magnetic flux density	T [tesla(s)] $\left\{ \begin{array}{l} 1T=1N/(A\cdot m) \\ =1Wb/m^2 \\ =1V\cdot s/m^2 \end{array} \right\}$	Gs [gauss(es)] γ [gamma(s)]	1 Gs = 10 ⁻⁴ T 1 γ = 10 ⁻⁹ T	1 T = 10 ⁴ Gs 1 T = 10 ⁹ γ
Magnetic flux	Wb [weber(s)] {1 Wb = 1 V·s}	Mx [maxwell(s)]	1 Mx = 10 ⁻⁸ Wb	1 Wb = 10 ⁸ Mx
Self inductance	H [henry(-ries)] {1 H = 1 Wb/A}			
Resistance (to direct current)	Ω [ohm(s)] {1 Ω = 1 V/A}			
Conductance (to direct current)	S [siemens] {1 S = 1 A/V}			
Active power	W $\left\{ \begin{array}{l} 1W=1J/s \\ =1A\cdot V \end{array} \right\}$			

Supplementary table 12 Inch/millimeter conversion

Inch		Inches										
		0	1	2	3	4	5	6	7	8	9	10
		mm										
0	0	0	25.4000	50.8000	76.2000	101.6000	127.0000	152.4000	177.8000	203.2000	228.6000	254.0000
1/64	0.015625	0.3969	25.7969	51.1969	76.5969	101.9969	127.3969	152.7969	178.1969	203.5969	228.9969	254.3969
1/32	0.03125	0.7938	26.1938	51.5938	76.9938	102.3938	127.7938	153.1938	178.5938	203.9938	229.3938	254.7938
3/64	0.046875	1.1906	26.5906	51.9906	77.3906	102.7906	128.1906	153.5906	178.9906	204.3906	229.7906	255.1906
1/16	0.0625	1.5875	26.9875	52.3875	77.7875	103.1875	128.5875	153.9875	179.3875	204.7875	230.1875	255.5875
5/64	0.078125	1.9844	27.3844	52.7844	78.1844	103.5844	128.9844	154.3844	179.7844	205.1844	230.5844	255.9844
3/32	0.09375	2.3812	27.7812	53.1812	78.5812	103.9812	129.3812	154.7812	180.1812	205.5812	230.9812	256.3812
7/64	0.109375	2.7781	28.1781	53.5781	78.9781	104.3781	129.7781	155.1781	180.5781	205.9781	231.3781	256.7781
1/8	0.125	3.1750	28.5750	53.9750	79.3750	104.7750	130.1750	155.5750	180.9750	206.3750	231.7750	257.1750
9/64	0.140625	3.5719	28.9719	54.3719	79.7719	105.1719	130.5719	155.9719	181.3719	206.7719	232.1719	257.5719
5/32	0.15625	3.9688	29.3688	54.7688	80.1688	105.5688	130.9688	156.3688	181.7688	207.1688	232.5688	257.9688
11/64	0.171875	4.3656	29.7656	55.1656	80.5656	105.9656	131.3656	156.7656	182.1656	207.5656	232.9656	258.3656
3/16	0.1875	4.7625	30.1625	55.5625	80.9625	106.3625	131.7625	157.1625	182.5625	207.9625	233.3625	258.7625
13/64	0.203125	5.1594	30.5594	55.9594	81.3594	106.7594	132.1594	157.5594	182.9594	208.3594	233.7594	259.1594
7/32	0.21875	5.5562	30.9562	56.3562	81.7562	107.1562	132.5562	157.9562	183.3562	208.7562	234.1562	259.5562
15/64	0.234375	5.9531	31.3531	56.7531	82.1531	107.5531	132.9531	158.3531	183.7531	209.1531	234.5531	259.9531
1/4	0.25	6.3500	31.7500	57.1500	82.5500	107.9500	133.3500	158.7500	184.1500	209.5500	234.9500	260.3500
17/64	0.265625	6.7469	32.1469	57.5469	82.9469	108.3469	133.7469	159.1469	184.5469	209.9469	235.3469	260.7469
9/32	0.28125	7.1438	32.5438	57.9438	83.3438	108.7438	134.1438	159.5438	184.9438	210.3438	235.7438	261.1438
19/64	0.296875	7.5406	32.9406	58.3406	83.7406	109.1406	134.5406	159.9406	185.3406	210.7406	236.1406	261.5406
5/16	0.3125	7.9375	33.3375	58.7375	84.1375	109.5375	134.9375	160.3375	185.7375	211.1375	236.5375	261.9375
21/64	0.328125	8.3344	33.7344	59.1344	84.5344	109.9344	135.3344	160.7344	186.1344	211.5344	236.9344	262.3344
11/32	0.34375	8.7312	34.1312	59.5312	84.9312	110.3312	135.7312	161.1312	186.5312	211.9312	237.3312	262.7312
23/64	0.359375	9.1281	34.5281	59.9281	85.3281	110.7281	136.1281	161.5281	186.9281	212.3281	237.7281	263.1281
3/8	0.375	9.5250	34.9250	60.3250	85.7250	111.1250	136.5250	161.9250	187.3250	212.7250	238.1250	263.5250
25/64	0.390625	9.9219	35.3219	60.7219	86.1219	111.5219	136.9219	162.3219	187.7219	213.1219	238.5219	263.9219
13/32	0.40625	10.3188	35.7188	61.1188	86.5188	111.9188	137.3188	162.7188	188.1188	213.5188	238.9188	264.3188
27/64	0.421875	10.7156	36.1156	61.5156	86.9156	112.3156	137.7156	163.1156	188.5156	213.9156	239.3156	264.7156
7/16	0.4375	11.1125	36.5125	61.9125	87.3125	112.7125	138.1125	163.5125	188.9125	214.3125	239.7125	265.1125
29/64	0.453125	11.5094	36.9094	62.3094	87.7094	113.1094	138.5094	163.9094	189.3094	214.7094	240.1094	265.5094
15/32	0.46875	11.9062	37.3062	62.7062	88.1062	113.5062	138.9062	164.3062	189.7062	215.1062	240.5062	265.9062
31/64	0.484375	12.3031	37.7031	63.1031	88.5031	113.9031	139.3031	164.7031	190.1031	215.5031	240.9031	266.3031
1/2	0.5	12.7000	38.1000	63.5000	88.9000	114.3000	139.7000	165.1000	190.5000	215.9000	241.3000	266.7000
33/64	0.515625	13.0969	38.4969	63.8969	89.2969	114.6969	140.0969	165.4969	190.8969	216.2969	241.6969	267.0969
17/32	0.53125	13.4938	38.8938	64.2938	89.6938	115.0938	140.4938	165.8938	191.2938	216.6938	242.0938	267.4938
35/64	0.546875	13.8906	39.2906	64.6906	90.0906	115.4906	140.8906	166.2906	191.6906	217.0906	242.4906	267.8906
9/16	0.5625	14.2875	39.6875	65.0875	90.4875	115.8875	141.2875	166.6875	192.0875	217.4875	242.8875	268.2875
37/64	0.578125	14.6844	40.0844	65.4844	90.8844	116.2844	141.6844	167.0844	192.4844	217.8844	243.2844	268.6844
19/32	0.59375	15.0812	40.4812	65.8812	91.2812	116.6812	142.0812	167.4812	192.8812	218.2812	243.6812	269.0812
39/64	0.609375	15.4781	40.8781	66.2781	91.6781	117.0781	142.4781	167.8781	193.2781	218.6781	244.0781	269.4781
5/8	0.625	15.8750	41.2750	66.6750	92.0750	117.4750	142.8750	168.2750	193.6750	219.0750	244.4750	269.8750
41/64	0.640625	16.2719	41.6719	67.0719	92.4719	117.8719	143.2719	168.6719	194.0719	219.4719	244.8719	270.2719
21/32	0.65625	16.6688	42.0688	67.4688	92.8688	118.2688	143.6688	169.0688	194.4688	219.8688	245.2688	270.6688
43/64	0.671875	17.0656	42.4656	67.8656	93.2656	118.6656	144.0656	169.4656	194.8656	220.2656	245.6656	271.0656
11/16	0.6875	17.4625	42.8625	68.2625	93.6625	119.0625	144.4625	169.8625	195.2625	220.6625	246.0625	271.4625
45/64	0.703125	17.8594	43.2594	68.6594	94.0594	119.4594	144.8594	170.2594	195.6594	221.0594	246.4594	271.8594
23/32	0.71875	18.2562	43.6562	69.0562	94.4562	119.8562	145.2562	170.6562	196.0562	221.4562	246.8562	272.2562
47/64	0.734375	18.6531	44.0531	69.4531	94.8531	120.2531	145.6531	171.0531	196.4531	221.8531	247.2531	272.6531
3/4	0.75	19.0500	44.4500	69.8500	95.2500	120.6500	146.0500	171.4500	196.8500	222.2500	247.6500	273.0500
49/64	0.765625	19.4469	44.8469	70.2469	95.6469	121.0469	146.4469	171.8469	197.2469	222.6469	248.0469	273.4469
25/32	0.78125	19.8438	45.2438	70.6438	96.0438	121.4438	146.8438	172.2438	197.6438	223.0438	248.4438	273.8438
51/64	0.796875	20.2406	45.6406	71.0406	96.4406	121.8406	147.2406	172.6406	198.0406	223.4406	248.8406	274.2406
13/16	0.8125	20.6375	46.0375	71.4375	96.8375	122.2375	147.6375	173.0375	198.4375	223.8375	249.2375	274.6375
53/64	0.828125	21.0344	46.4344	71.8344	97.2344	122.6344	148.0344	173.4344	198.8344	224.2344	249.6344	275.0344
27/32	0.84375	21.4312	46.8312	72.2312	97.6312	123.0312	148.4312	173.8312	199.2312	224.6312	250.0312	275.4312
55/64	0.859375	21.8281	47.2281	72.6281	98.0281	123.4281	148.8281	174.2281	199.6281	225.0281	250.4281	275.8281
7/8	0.875	22.2250	47.6250	73.0250	98.4250	123.8250	149.2250	174.6250	200.0250	225.4250	250.8250	276.2250
57/64	0.890625	22.6219	48.0219	73.4219	98.8219	124.2219	149.6219	175.0219	199.4219	225.8219	251.2219	276.6219
29/32	0.90625	23.0188	48.4188	73.8188	99.2188	124.6188	150.0188	175.4188	200.8188	226.2188	251.6188	277.0188
59/64	0.921875	23.4156	48.8156	74.2156	99.6156	125.0156	150.4156	175.8156	201.2156	226.6156	252.0156	277.4156
15/16	0.9375	23.8125	49.2125	74.6125	100.0125	125.4125	150.8125	176.2125	201.6125	227.0125	252.4125	277.8125
61/64	0.953125	24.2094	49.6094	75.0094	100.4094	125.8094	151.2094	176.6094	202.0094	227.4094	252.8094	278.2094
31/32	0.96875	24.6062	50.0062	75.4062	100.8062	126.2062	151.6062	177.0062	202.4062	227.8062	253.2062	278.6062
63/64	0.984375	25.0031	50.4031	75.8031	101.2031	126.6031	152.0031	177.4031	202.8031	228.2031	253.6031	279.0031

Supplementary table 13 Steel hardness conversion

Rockwell C-scale 1 471.0 N	Vicker's	Brinell		Rockwell		Shore
		Standard ball	Tungsten carbide ball	A-scale 588.4 N	B-scale 980.7 N	
68	940			85.6		97
67	900			85.0		95
66	865			84.5		92
65	832		739	83.9		91
64	800		722	83.4		88
63	772		705	82.8		87
62	746		688	82.3		85
61	720		670	81.8		83
60	697		654	81.2		81
59	674		634	80.7		80
58	653		615	80.1		78
57	633		595	79.6		76
56	613		577	79		

Supplementary table 14 Surface roughness comparison

Arithmetical mean deviation of the profile R _a	Maximum height of the profile R _{max}	Ten-point height of irregularities R _z	Roughness grade numbers N
0.013 a	0.05 S	0.05 Z	-
0.025 a	0.1 S	0.1 Z	N 1
0.05 a	0.2 S	0.2 Z	N 2
0.10 a	0.4 S	0.4 Z	N 3
0.20 a	0.8 S	0.8 Z	N 4
0.40 a	1.6 S	1.6 Z	N 5
0.80 a	3.2 S	3.2 Z	N 6
1.6 a	6.3 S	6.3 Z	N 7
3.2 a	12.5 S	12.5 Z	N 8
6.3 a	25 S	25 Z	N 9
12.5 a	50 S	50 Z	N 10
25 a	100 S	100 Z	N 11
50 a	200 S	200 Z	N 12
100 a	400 S	400 Z	-

[Note] Above table is applicable only when processed surface peaks are of equal height.
Above table is roughly applicable to processed surface for general use.
Numbers are combined only for convenience in deciding surface roughness.

Supplementary table 15 Viscosity conversion

Kinematic viscosity mm ² /s	Saybolt SUS (second)		Redwood R (second)		Engler E (degree)
	100°F	210°F	50°C	100°C	
2	32.6	32.8	30.8	31.2	1.14
3	36.0	36.3	33.3	33.7	1.22
4	39.1	39.4	35.9	36.5	1.31
5	42.3	42.6	38.5	39.1	1.40
6	45.5	45.8	41.1	41.7	1.48
7	48.7	49.0	43.7	44.3	1.56
8	52.0	52.4	46.3	47.0	1.65
9	55.4	55.8	49.1	50.0	1.75
10	58.8	59.2	52.1	52.9	1.84
11	62.3	62.7	55.1	56.0	1.93
12	65.9	66.4	58.2	59.1	2.02
13	69.6	70.1	61.4	62.3	2.12
14	73.4	73.9	64.7	65.6	2.22
15	77.2	77.7	68.0	69.1	2.32
16	81.1	81.7	71.5	72.6	2.43
17	85.1	85.7	75.0	76.1	2.54
18	89.2	89.8	78.6	79.7	2.64
19	93.3	94.0	82.1	83.6	2.76
20	97.5	98.2	85.8	87.4	2.87
21	102	102	89.5	91.3	2.98
22	106	107	93.3	95.1	3.10
23	110	111	97.1	98.9	3.22
24	115	115	101	103	3.34
25	119	120	105	107	3.46
26	123	124	109	111	3.58
27	128	129	112	115	3.70
28	132	133	116	119	3.82
29	137	138	120	123	3.95
30	141	142	124	127	4.07
31	145	146	128	131	4.20
32	150	150	132	135	4.32
33	154	155	136	139	4.45
34	159	160	140	143	4.57
35	163	164	144	147	4.70
36	168	170	148	151	4.83
37	172	173	153	155	4.96
38	177	178	156	159	5.08
39	181	183	160	164	5.21
40	186	187	164	168	5.34
41	190	192	168	172	5.47
42	195	196	172	176	5.59
43	199	201	176	180	5.72
44	204	205	180	185	5.85
45	208	210	184	189	5.98
46	213	215	188	193	6.11
47	218	219	193	197	6.24
48	222	224	197	202	6.37
49	227	228	201	206	6.50
50	231	233	205	210	6.63
55	254	256	225	231	7.24
60	277	279	245	252	7.90
65	300	302	266	273	8.55
70	323	326	286	294	9.21
75	346	349	306	315	9.89
80	371	373	326	336	10.5
85	394	397	347	357	11.2
90	417	420	367	378	11.8
95	440	443	387	399	12.5
100	464	467	408	420	13.2
120	556	560	490	504	15.8
140	649	653	571	588	18.4
160	742	747	653	672	21.1
180	834	840	734	757	23.7
200	927	933	816	841	26.3
250	1159	1167	1020	1051	32.9
300	1391	1400	1224	1241	39.5

[Remark] 1mm²/s = 1 cSt (centi stokes)

Bearing No. index

Bearing series (series name)	Description	Page
02400	Single-row tapered roller bearing, inch series	A9, A55, A56, A59, B227, B229, B231
02800	Single-row tapered roller bearing, inch series	A9, A55, A56, A59, B229, B231, B233
03000	Single-row tapered roller bearing, inch series	A9, A55, A56, A59, B225
07000	Single-row tapered roller bearing, inch series	A9, A55, A56, A59, B225, B227
08000	Single-row tapered roller bearing, inch series	A9, A55, A56, A59, B231
09000	Single-row tapered roller bearing, inch series	A9, A55, A56, A59, B225
11000R	Single-row tapered roller bearing, inch series	A9, A55, A56, A59, B237
112	Self-aligning ball bearing, extended inner ring type	A6, A55, A56, B125, B134
113	Self-aligning ball bearing, extended inner ring type	A6, A55, A56, B125, B134
12	Self-aligning ball bearing, open type	A6, A55, A56, B125, B126
12-K	Self-aligning ball bearing, open type, tapered bore	A6, A56, B125, B126
1200	Single-row tapered roller bearing, inch series	A9, A55, A56, A59, B227
12000	Single-row tapered roller bearing, inch series	A9, A55, A56, A59, B239
12500	Single-row tapered roller bearing, inch series	A9, A55, A56, A59, B225
13	Self-aligning ball bearing, open type	A6, A55, A56, B125, B126
13-K	Self-aligning ball bearing, open type, tapered bore	A6, A56, B125, B126
1300	Single-row tapered roller bearing, inch series	A9, A55, A56, A59, B225
13600	Single-row tapered roller bearing, inch series	A9, A55, A56, A59, B235
13800	Single-row tapered roller bearing, inch series	A9, A55, A56, A59, B233, B235
14000	Single-row tapered roller bearing, inch series	A9, A55, A56, A59, B229, B231
15000	Single-row tapered roller bearing, inch series	A9, A55, A56, A59, B227, B229, B231
15500	Single-row tapered roller bearing, inch series	A9, A55, A56, A59, B229
160	Single-row deep groove ball bearing, open type	A4, A55, B7, B8
16000	Single-row tapered roller bearing, inch series	A9, A55, A56, A59, B233, B235
1700	Single-row tapered roller bearing, inch series	A9, A55, A56, A59, B227
17000	Single-row tapered roller bearing, inch series	A9, A55, A56, A59, B227, B229
17500R	Single-row tapered roller bearing, inch series	A9, A55, A56, A59, B225
18000	Single-row tapered roller bearing, inch series	A9, A55, A56, A59, B243
18500	Single-row tapered roller bearing, inch series	A9, A55, A56, A59, B235, B237
18600	Single-row tapered roller bearing, inch series	A9, A55, A56, A59, B239, B241
18700	Single-row tapered roller bearing, inch series	A9, A55, A56, A59, B243
19000R	Single-row tapered roller bearing, inch series	A9, A55, A56, A59, B235
1900R	Single-row tapered roller bearing, inch series	A9, A55, A56, A59, B227, B229
1WC	Miniature one-way clutch, with metal spring	B482, B484
20DC	Cylindrical roller bearing for railway rolling stock axle journal	C22, C25
21000	Single-row tapered roller bearing, inch series	A9, A55, A56, A59, B225
213	Spherical roller bearing	A10, A55, A56, A59, B291, B294
22	Self-aligning ball bearing, open type	A6, A55, A56, B125, B126
22-2RS	Self-aligning ball bearing, sealed type	A6, A56, B125, B132
22-K	Self-aligning ball bearing, open type, tapered bore	A6, A56, B125, B126
222	Spherical roller bearing	A10, A55, A56, A59, B291, B294
223	Spherical roller bearing	A10, A55, A56, A59, B291, B294
23	Self-aligning ball bearing, open type	A6, A55, A56, B125, B126
23-2RS	Self-aligning ball bearing, sealed type	A6, A56, B125, B132
23-K	Self-aligning ball bearing, open type, tapered bore	A6, A56, B125, B126
230	Spherical roller bearing	A10, A55, A56, A59, B291, B296

Bearing series (series name)	Description	Page
230-K	Spherical roller bearing, tapered bore	A10, A55, A56, A59, B291, B296
231	Spherical roller bearing	A10, A55, A56, A59, B291, B294
231-K	Spherical roller bearing, tapered bore	A10, A55, A56, A59, B291, B294
232	Spherical roller bearing	A10, A55, A56, A59, B291, B296
232-K	Spherical roller bearing, tapered bore	A10, A55, A56, A59, B291, B296
23600	Single-row tapered roller bearing, inch series	A9, A55, A56, A59, B233
238	Spherical roller bearing	A10, A55, A56, A59, B291, B314
238-K	Spherical roller bearing, tapered bore	A10, A55, A56, A59, B291, B314
239	Spherical roller bearing	A10, A55, A56, A59, B291, B300
239-K	Spherical roller bearing, tapered bore	A10, A55, A56, A59, B291, B300
240	Spherical roller bearing	A10, A55, A56, A59, B291, B298
240-K	Spherical roller bearing, tapered bore	A10, A55, A56, A59, B291, B298
241	Spherical roller bearing	A10, A55, A56, A59, B291, B298
241-K	Spherical roller bearing, tapered bore	A10, A55, A56, A59, B291, B298
24700R	Single-row tapered roller bearing, inch series	A9, A55, A56, A59, B237
2500	Single-row tapered roller bearing, inch series	A9, A55, A56, A59, B231
25500	Single-row tapered roller bearing, inch series	A9, A55, A56, A59, B235, B239, B241
25800R	Single-row tapered roller bearing, inch series	A9, A55, A56, A59, B233
2600	Single-row tapered roller bearing, inch series	A9, A55, A56, A59, B227, B229
26000	Single-row tapered roller bearing, inch series	A9, A55, A56, A59, B229, B231
26800R	Single-row tapered roller bearing, inch series	A9, A55, A56, A59, B233, B239
2700R	Single-row tapered roller bearing, inch series	A9, A55, A56, A59, B233, B235
27600	Single-row tapered roller bearing, inch series	A9, A55, A56, A59, B257, B259
27800	Single-row tapered roller bearing, inch series	A9, A55, A56, A59, B235
28000	Single-row tapered roller bearing, inch series	A9, A55, A56, A59, B233, B235
28500R	Single-row tapered roller bearing, inch series	A9, A55, A56, A59, B243, B245
28600	Single-row tapered roller bearing, inch series	A9, A55, A56, A59, B243, B247
28900	Single-row tapered roller bearing, inch series	A9, A55, A56, A59, B249
2900	Single-row tapered roller bearing, inch series	A9, A55, A56, A59, B241
292	Spherical thrust roller bearing	A11, A55, A56, A59, B355, B358
293	Spherical thrust roller bearing	A11, A55, A56, A59, B355, B356
294	Spherical thrust roller bearing	A11, A55, A56, A59, B355, B356
29500	Single-row tapered roller bearing, inch series	A9, A55, A56, A59, B249
29600	Single-row tapered roller bearing, inch series	A9, A55, A56, A59, B253, B255
2CR	Cylindrical roller bearing for railway rolling stock axle journal	C22, C25
2U	Cylindrical roller bearing for railway rolling stock axle journal	C22, C25
302	Single-row tapered roller bearing, metric series	A9, A55, A56, B185, B194
303	Single-row tapered roller bearing, metric series	A9, A55, A56, B185, B194
3100	Single-row tapered roller bearing, inch series	A9, A55, A56, A59, B229
313	Single-row tapered roller bearing, metric series	A9, A55, A56, B185, B214
31500	Single-row tapered roller bearing, inch series	A9, A55, A56, A59, B233
32	Double-row angular contact ball bearing (with filling slot)	A5, A55, A56, B55, B118
320	Single-row tapered roller bearing, metric series	A9, A55, A56, B185, B194
322	Single-row tapered roller bearing, metric series	A9, A55, A56, B185, B194
323	Single-row tapered roller bearing, metric series	A9, A55, A56, B185, B194

Bearing No. index

Bearing series (series name)	Description	Page
329	Single-row tapered roller bearing, metric series	A9, A55, B185, B198
33	Double-row angular contact ball bearing (with filling slot)	A5, A55, A56, B55, B118
330	Single-row tapered roller bearing, metric series	A9, A55, A56, B185, B196
3300	Single-row tapered roller bearing, inch series	A9, A55, A56, A59, B235
33000	Single-row tapered roller bearing, inch series	A9, A55, A56, A59, B247, B251, B253
331	Single-row tapered roller bearing, metric series	A9, A55, B185, B200
332	Single-row tapered roller bearing, metric series	A9, A55, B185, B196
335	Single-row tapered roller bearing, inch series	A9, A55, A56, A59, B233, B235, B237
33800	Single-row tapered roller bearing, inch series	A9, A55, A56, A59, B239, B243, B245
3400	Single-row tapered roller bearing, inch series	A9, A55, A56, A59, B233, B235
34000	Single-row tapered roller bearing, inch series	A9, A55, A56, A59, B253, B255, B257
3500R	Single-row tapered roller bearing, inch series	A9, A55, A56, A59, B233, B237, B239
355	Single-row tapered roller bearing, inch series	A9, A55, A56, A59, B237, B239, B241
365	Single-row tapered roller bearing, inch series	A9, A55, A56, A59, B237, B241, B243, B245
3700	Single-row tapered roller bearing, inch series	A9, A55, A56, A59, B239, B243
37000	Single-row tapered roller bearing, inch series	A9, A55, A56, A59, B263, B265
375	Single-row tapered roller bearing, inch series	A9, A55, A56, A59, B243
3800	Single-row tapered roller bearing, inch series	A9, A55, A56, A59, B233, B237
385	Single-row tapered roller bearing, inch series	A9, A55, A56, A59, B241, B243, B247
3900	Single-row tapered roller bearing, inch series	A9, A55, A56, A59, B247, B251
395	Single-row tapered roller bearing, inch series	A9, A55, A56, A59, B243, B249, B251
39500	Single-row tapered roller bearing, inch series	A9, A55, A56, A59, B245, B247, B249, B251
41000	Single-row tapered roller bearing, inch series	A9, A55, A56, A59, B229
415	Single-row tapered roller bearing, inch series	A9, A55, A56, A59, B235, B237
42	Double-row deep groove ball bearing	A4, A55, A56, B5, B52
42600	Single-row tapered roller bearing, inch series	A9, A55, A56, A59, B255, B257
43	Double-row deep groove ball bearing	A4, A55, A56, B5, B52
4300	Single-row tapered roller bearing, inch series	A9, A55, A56, A59, B235, B237
435	Single-row tapered roller bearing, inch series	A9, A55, A56, A59, B233, B239
4500	Single-row tapered roller bearing, inch series	A9, A55, A56, A59, B245
452	Double-row tapered roller bearing (TDI type)	A9, A55, A56, B284
45200	Single-row tapered roller bearing, inch series	A9, A55, A56, A59, B241, B243, B247
453	Double-row tapered roller bearing (TDI type)	A9, A55, A56, B284
455	Single-row tapered roller bearing, inch series	A9, A55, A56, A59, B241, B245, B247
46000	Single-row tapered roller bearing, inch series	A9, A55, A56, A59, B237, B239
462	Double-row tapered roller bearing (TDO type)	A9, A55, A56, B268
46T	Double-row tapered roller bearing (TDO type)	A9, A55, A56, B268
47400R	Single-row tapered roller bearing, inch series	A9, A55, A56, A59, B253
475	Single-row tapered roller bearing, inch series	A9, A55, A56, A59, B249, B253
47600R	Single-row tapered roller bearing, inch series	A9, A55, A56, A59, B255, B257
47800R	Single-row tapered roller bearing, inch series	A9, A55, A56, A59, B261
48100	Single-row tapered roller bearing, inch series	A9, A55, A56, A59, B263
48600	Single-row tapered roller bearing, inch series	A9, A55, A56, A59, B267
49000	Single-row tapered roller bearing, inch series	A9, A55, A56, A59, B239
495	Single-row tapered roller bearing, inch series	A9, A55, A56, A59, B255, B257, B259

Bearing series (series name)	Description	Page
49500	Single-row tapered roller bearing, inch series	A9, A55, A56, A59, B239, B243
4UJ	Cylindrical roller bearing for railway rolling stock axle journal	C22, C25
511	Single direction thrust ball bearing with flat back face	A11, A55, A56, A59, B337, B338
512	Single direction thrust ball bearing with flat back face	A11, A55, A56, A59, B337, B338
513	Single direction thrust ball bearing with flat back face	A11, A55, A56, A59, B337, B338
514	Single direction thrust ball bearing with flat back face	A11, A55, A56, A59, B337, B338
52	Double-row angular contact ball bearing	A5, A55, A56, B55, B118
52--2RS	Double-row angular contact ball bearing, contact sealed	A5, A56, B55, B118
52--ZZ	Double-row angular contact ball bearing, shielded	A5, A56, B55, B118
52000	Single-row tapered roller bearing, inch series	A9, A55, A56, A59, B261, B263
522	Double direction thrust ball bearing with flat back faces	A11, A55, A56, B337, B348
523	Double direction thrust ball bearing with flat back faces	A11, A55, A56, B337, B348
524	Double direction thrust ball bearing with flat back faces	A11, A55, A56, B337, B348
525	Single-row tapered roller bearing, inch series	A9, A55, A56, A59, B235, B237, B238, B241, B243
53	Double-row angular contact ball bearing	A5, A55, A56, B55, B118
53--2RS	Double-row angular contact ball bearing, contact sealed	A5, A56, B55, B118
53--ZZ	Double-row angular contact ball bearing, shielded	A5, A56, B55, B118
532	Single direction thrust ball bearing with spherical back face	A11, A55, A56, A59, B337, B338
532--U	Single direction thrust ball bearing with aligning seat race	A11, A55, A56, A59, B337, B338
533	Single direction thrust ball bearing with spherical back face	A11, A55, A56, A59, B337, B338
533--U	Single direction thrust ball bearing with aligning seat race	A11, A55, A56, A59, B337, B338
534	Single direction thrust ball bearing with spherical back face	A11, A55, A56, A59, B337, B338
534--U	Single direction thrust ball bearing with aligning seat race	A11, A55, A56, A59, B337, B338
535	Single-row tapered roller bearing, inch series	A9, A55, A56, A59, B237, B239, B245
542	Double direction thrust ball bearing with spherical back faces	A11, A55, A56, B337, B348
542--U	Double direction thrust ball bearing with aligning seat races	A11, A55, A56, B337, B348
543	Double direction thrust ball bearing with spherical back faces	A11, A55, A56, B337, B348
543--U	Double direction thrust ball bearing with aligning seat races	A11, A55, A56, B337, B348
544	Double direction thrust ball bearing with spherical back faces	A11, A55, A56, B337, B348

Bearing No. index

Bearing series (series name)	Description	Page
544-U	Double direction thrust ball bearing with aligning seat races	A11, A55, A56, B337, B348
5500R	Single-row tapered roller bearing, inch series	A9, A55, A56, A59, B245, B247, B249, B251
555	Single-row tapered roller bearing, inch series	A9, A55, A56, A59, B245
56000R	Single-row tapered roller bearing, inch series	A9, A55, A56, A59, B263
565	Single-row tapered roller bearing, inch series	A9, A55, A56, A59, B249, B251, B253, B256
5700	Single-row tapered roller bearing, inch series	A9, A55, A56, A59, B255
575R	Single-row tapered roller bearing, inch series	A9, A55, A56, A59, B253, B255, B257
59000	Single-row tapered roller bearing, inch series	A9, A55, A56, A59, B243
595	Single-row tapered roller bearing, inch series	A9, A55, A56, A59, B259, B261
60	Single-row deep groove ball bearing, open type, extra-small ball bearing, miniature ball bearing, open type	A4, A55, A56, B5, B7, B8, B40
60-2RD	Single-row deep groove ball bearing, extremely light contact sealed, extra-small ball bearing, miniature ball bearing, extremely light contact sealed	A4, A56, B5, B6, B20, B42
60-2RS	Single-row deep groove ball bearing, contact sealed, extra-small ball bearing, miniature ball bearing, contact sealed	A4, A56, B5, B6, B20, B42
60-2RU	Single-row deep groove ball bearing, non-contact sealed, extra-small ball bearing, miniature ball bearing, non-contact sealed	A4, A56, B5, B6, B20, B42
60-N	Single-row deep groove ball bearing, snap ring groove type	A4, A56, B5, B32
60-NR	Single-row deep groove ball bearing, snap ring groove type, locating snap ring type	A4, A56, B5, B32
60-ZZ	Single-row deep groove ball bearing, shielded, extra-small ball bearing, miniature ball bearing, shielded	A4, A56, B5, B6, B20, B42
615	Single-row tapered roller bearing, inch series	A9, A55, A56, A59, B239, B245, B247
62	Single-row deep groove ball bearing, open type, extra-small ball bearing, miniature ball bearing, open type	A4, A48, A54, A55, A56, B7, B8, B40
62-2RD	Single-row deep groove ball bearing, extremely light contact sealed, extra-small ball bearing, miniature ball bearing, extremely light contact sealed	A4, A56, B5, B6, B20, B42
62-2RS	Single-row deep groove ball bearing, contact sealed, extra-small ball bearing, miniature ball bearing, contact sealed	A4, A56, B5, B6, B20, B40
62-2RU	Single-row deep groove ball bearing, non-contact sealed, extra-small ball bearing, miniature ball bearing, non-contact sealed	A4, A56, B5, B6, B20, B42
62-N	Single-row deep groove ball bearing, snap ring groove type	A4, A56, B5, B32
62-NR	Single-row deep groove ball bearing, snap ring groove type, locating snap ring type	A4, A56, B5, B32
62-ZZ	Single-row deep groove ball bearing, shielded, extra-small ball bearing, miniature ball bearing, shielded	A4, A56, B5, B6, B20, B40

Bearing series (series name)	Description	Page
63	Single-row deep groove ball bearing, open type, extra-small ball bearing, miniature ball bearing, open type	A4, A46, A49, A55, A56, B5, B7, B8, B40
63-2RD	Single-row deep groove ball bearing, extremely light contact sealed, extra-small ball bearing, miniature ball bearing, extremely light contact sealed	A4, A56, B4, B5, B6, B20
63-2RS	Single-row deep groove ball bearing, contact sealed, extra-small ball bearing, miniature ball bearing, contact sealed	A4, A56, B5, B6, B20, B42
63-2RU	Single-row deep groove ball bearing, non-contact sealed, extra-small ball bearing, miniature ball bearing, non-contact sealed	A4, A56, B5, B6, B20, B42
63-N	Single-row deep groove ball bearing, snap ring groove type	A4, A56, B5, B32
63-NR	Single-row deep groove ball bearing, snap ring groove type, locating snap ring type	A4, A56, B5, B32
63-ZZ	Single-row deep groove ball bearing, shielded, extra-small ball bearing, miniature ball bearing, shielded	A4, A56, B5, B6, B20, B40
6300	Single-row tapered roller bearing, inch series	A9, A55, A56, A59, B245, B249, B251
635	Single-row tapered roller bearing, inch series	A9, A55, A56, A59, B251
64	Single-row deep groove ball bearing, open type	A4, A55, B7, B8
6400	Single-row tapered roller bearing, inch series	A9, A55, A56, A59, B255
64000R	Single-row tapered roller bearing, inch series	A9, A55, A56, A59, B265
65000	Single-row tapered roller bearing, inch series	A9, A55, A56, A59, B245, B247, B249
6500R	Single-row tapered roller bearing, inch series	A9, A55, A56, A59, B259, B261
65300	Single-row tapered roller bearing, inch series	A9, A55, A56, A59, B241
655	Single-row tapered roller bearing, inch series	A9, A55, A56, A59, B253, B255, B257, B259
66000R	Single-row tapered roller bearing, inch series	A9, A55, A56, A59, B245
66500	Single-row tapered roller bearing, inch series	A9, A55, A56, A59, B245, B247
67	Single-row deep groove ball bearing, open type	A4, A55, B7, B8
67-2RS	Single-row deep groove ball bearing, contact sealed	A4, A56, B5, B6, B20
67-2RU	Single-row deep groove ball bearing, non-contact sealed	A4, A56, B5, B6, B20
67-ZZ	Single-row deep groove ball bearing, shielded	A4, A56, B5, B6, B20
675	Single-row tapered roller bearing, inch series	A9, A55, A56, A59, B259, B261, B263
68	Single-row deep groove ball bearing, open type, extra-small ball bearing, miniature ball bearing, open type	A4, A55, A56, B5, B7, B8, B40
68-2RD	Single-row deep groove ball bearing, extremely light contact sealed	A4, A56, B5, B6, B20
68-2RS	Single-row deep groove ball bearing, contact sealed	A4, A56, B5, B6, B20
68-2RU	Single-row deep groove ball bearing, non-contact sealed	A4, A56, B5, B6, B20
68-N	Single-row deep groove ball bearing, snap ring groove type	A4, A56, B5, B32
68-NR	Single-row deep groove ball bearing, snap ring groove type, locating snap ring type	A4, A56, B5, B32
68-ZZ	Single-row deep groove ball bearing, shielded	A4, A56, B5, B6, B20
68000	Single-row tapered roller bearing, inch series	A9, A55, A56, A59, B265

Bearing No. index

Bearing series (series name)	Description	Page
69	Single-row deep groove ball bearing, open type, extra-small ball bearing, miniature ball bearing, open type	A4, A55, A56, B5, B7, B8, B40
69-2RD	Single-row deep groove ball bearing, extremely light contact sealed, extra-small ball bearing, miniature ball bearing, extremely light contact sealed	A4, A56, B5, B6, B20, B42
69-2RS	Single-row deep groove ball bearing, contact sealed, extra-small ball bearing, miniature ball bearing, contact sealed	A4, A56, B5, B6, B20, B42
69-2RU	Single-row deep groove ball bearing, non-contact sealed, extra-small ball bearing, miniature ball bearing, non-contact sealed	A4, A56, B5, B6, B20, B42
69-N	Single-row deep groove ball bearing, snap ring groove type	A4, A56, B5, B32
69-NR	Single-row deep groove ball bearing, snap ring groove type, locating snap ring type	A4, A56, B5, B32
69-ZZ	Single-row deep groove ball bearing, shielded, extra-small ball bearing, miniature ball bearing, shielded	A4, A56, B5, B6, B20, B42
70	Single-row angular contact ball bearing	A5, A55, A56, B55, B62
70-DB	Matched pair angular contact ball bearing, back-to-back arrangement	A5, A56, B55, B90
70-DF	Matched pair angular contact ball bearing, face-to-face arrangement	A5, A56, B55, B90
70-DT	Matched pair angular contact ball bearing, tandem arrangement	A5, A56, B55, B90
71000	Single-row tapered roller bearing, inch series	A9, A55, A56, A59, B263, B265
72	Single-row angular contact ball bearing	A5, A55, A56, B55, B62
72-DB	Matched pair angular contact ball bearing, back-to-back arrangement	A5, A56, B55, B90
72-DF	Matched pair angular contact ball bearing, face-to-face arrangement	A5, A56, B55, B90
72-DT	Matched pair angular contact ball bearing, tandem arrangement	A5, A56, B55, B90
73	Single-row angular contact ball bearing	A5, A55, A56, B55, B62
73-DB	Matched pair angular contact ball bearing, back-to-back arrangement	A5, A56, B55, B90
73-DF	Matched pair angular contact ball bearing, face-to-face arrangement	A5, A56, B55, B90
73-DT	Matched pair angular contact ball bearing, tandem arrangement	A5, A56, B55, B90
74	Single-row angular contact ball bearing	A5, A55, A56, B55, B64
74-DB	Matched pair angular contact ball bearing, back-to-back arrangement	A5, A56, B55, B92
74-DF	Matched pair angular contact ball bearing, face-to-face arrangement	A5, A56, B55, B92
74-DT	Matched pair angular contact ball bearing, tandem arrangement	A5, A56, B55, B92
745R	Single-row tapered roller bearing, inch series	A9, A55, A56, A59, B253, B255, B257, B259
755	Single-row tapered roller bearing, inch series	A9, A55, A56, A59, B255, B257, B259, B261
775	Single-row tapered roller bearing, inch series	A9, A55, A56, A59, B261, B263

Bearing series (series name)	Description	Page
79	Single-row angular contact ball bearing	A5, A55, A56, B55, B62
79-DB	Matched pair angular contact ball bearing, back-to-back arrangement	A5, A56, B55, B90
79-DF	Matched pair angular contact ball bearing, face-to-face arrangement	A5, A56, B55, B90
79-DT	Matched pair angular contact ball bearing, tandem arrangement	A5, A56, B55, B90
835R	Single-row tapered roller bearing, inch series	A9, A55, A56, A59, B253, B259
855R	Single-row tapered roller bearing, inch series	A9, A55, A56, A59, B259, B261, B263
9100	Single-row tapered roller bearing, inch series	A9, A55, A56, A59, B251
935	Single-row tapered roller bearing, inch series	A9, A55, A56, A59, B263, B265
98000	Single-row tapered roller bearing, inch series	A9, A55, A56, A59, B257, B259, B261, B263
A2000	Single-row tapered roller bearing, inch series	A9, A55, A56, A59, B225
A4000	Single-row tapered roller bearing, inch series	A9, A55, A56, A59, B225
AH22	Withdrawal sleeve for spherical roller bearing	A10, A55, A56, B329
AH23	Withdrawal sleeve for spherical roller bearing	A10, A55, A56, B326
AH240	Withdrawal sleeve for spherical roller bearing	A10, A55, A56, B328
AH241	Withdrawal sleeve for spherical roller bearing	A10, A55, A56, B327
AH3	Withdrawal sleeve for spherical roller bearing	A10, A55, A56, B326
AH30	Withdrawal sleeve for spherical roller bearing	A10, A55, A56, B328
AH31	Withdrawal sleeve for spherical roller bearing	A10, A55, A56, B328
AH32	Withdrawal sleeve for spherical roller bearing	A10, A55, A56, B329
AHX23	Withdrawal sleeve for spherical roller bearing	A10, A55, A56, B326
AHX3	Withdrawal sleeve for spherical roller bearing	A10, A55, A56, B326
AHX30	Withdrawal sleeve for spherical roller bearing	A10, A55, A56, B327
AHX31	Withdrawal sleeve for spherical roller bearing	A10, A55, A56, B327
AHX32	Withdrawal sleeve for spherical roller bearing	A10, A55, A56, B327
AL	Lock plate	C46, C55
ALL	Lock plate	C46, C55
AN	Locknut for adapter sleeve and shaft	C46, C47
ANL	Locknut for adapter sleeve and shaft	C46, C48
AS	Race, thrust needle roller and cage assembly, stamped, metric series	A12, B363, B444
AW	Lockwasher	C46, C53
AW-X	Lockwasher	C46, C53
AXK	Thrust needle roller and cage assemblies, without races, one-piece cage, metric series	A12, B363, B444
BK	Drawn cup needle roller bearing, caged, closed one end, metric series	A8, B363, B414
EWC	Miniature one-way clutch, with synthetic resin spring	B482, B484
F60	Extra-small ball bearing, miniature ball bearing, flanged type, open type	A4, A56, B5, B46
F60-ZZ	Extra-small ball bearing, miniature ball bearing, flanged type, shielded	A4, A56, B5, B46
F62	Extra-small ball bearing, miniature ball bearing, flanged type, open type	A4, A56, B5, B46
F62-ZZ	Extra-small ball bearing, miniature ball bearing, flanged type, shielded	A4, A56, B5, B46

Bearing No. index

Bearing series (series name)	Description	Page
F63	Extra-small ball bearing, miniature ball bearing, flanged type, open type	A4, A56, B5, B48
F63-ZZ	Extra-small ball bearing, miniature ball bearing, flanged type, shielded	A4, A56, B5, B48
F68	Extra-small ball bearing, miniature ball bearing, flanged type, open type	A4, A56, B5, B46
F69	Extra-small ball bearing, miniature ball bearing, flanged type, open type	A4, A56, B5, B46
F69-ZZ	Extra-small ball bearing, miniature ball bearing, flanged type, shielded	A4, A56, B5, B46
FNT	Thrust needle roller and cage assemblies, without races, two-piece cage, metric series	A12, B363, B444
GS.811	Race, thrust needle roller and cylindrical roller, housing piloted, metric series	A12, B363, B444
GS.812	Race for thrust cylindrical roller and cage assembly, housing piloted, metric series	A12, B363, B448
H2-X	Adapter assembly for self-aligning ball bearing	A6, B125, B136
H23	Adapter assembly for spherical roller bearing	A10, A55, A56, B320
H23-X	Adapter assembly for self-aligning ball bearing, adapter assembly for spherical roller bearing	A6, A10, A55, A56, B125, B136, B318
H3-X	Adapter assembly for self-aligning ball bearing, adapter assembly for spherical roller bearing	A6, A10, A55, A56, B125, B136, B318
H30	Adapter assembly for spherical roller bearing	A10, A55, A56, B320
H30-X	Adapter assembly for spherical roller bearing	A10, A55, A56, B318
H31	Adapter assembly for spherical roller bearing	A10, A55, A56, B320
H31-X	Adapter assembly for spherical roller bearing	A10, A55, A56, B318
H32	Adapter assembly for spherical roller bearing	A10, A55, A56, B323
H414200	Single-row tapered roller bearing, inch series	A9, A55, A56, A59, B249, B251, B253
H715300	Single-row tapered roller bearing, inch series	A9, A55, A56, A59, B249, B251, B253
HH221400	Single-row tapered roller bearing, inch series	A9, A55, A56, A59, B255, B257, B261, B263
HH224300	Single-row tapered roller bearing, inch series	A9, A55, A56, A59, B261, B263, B265
HH228300	Single-row tapered roller bearing, inch series	A9, A55, A56, A59, B265
HH506300	Single-row tapered roller bearing, inch series	A9, A55, A56, A59, B241
HH926700	Single-row tapered roller bearing, inch series	A9, A55, A56, A59, B265
HJ	Heavy-duty needle roller bearing, caged, with ribs (integral), without inner ring, lubricating hole and lubricating groove in the outer ring, inch series	A8, A55, A56, A59, B363, B440
HJ2	Thrust collar for cylindrical roller bearing	A7, B139, B168
HJ22	Thrust collar for cylindrical roller bearing	A7, B139, B168
HJ23	Thrust collar for cylindrical roller bearing	A7, B139, B168
HJ3	Thrust collar for cylindrical roller bearing	A7, B139, B168
HJ4	Thrust collar for cylindrical roller bearing	A7, B139, B168
HK	Drawn cup needle roller bearing, caged, open ends, metric series	A8, B363, B414
HM212000	Single-row tapered roller bearing, inch series	A9, A55, A56, A59, B249, B251
HM218200	Single-row tapered roller bearing, inch series	A9, A55, A56, A59, B261
HM516400	Single-row tapered roller bearing, inch series	A9, A55, A56, A59, B257
HM518400	Single-row tapered roller bearing, inch series	A9, A55, A56, A59, B259
HM617000	Single-row tapered roller bearing, inch series	A9, A55, A56, A59, B259

Bearing series (series name)	Description	Page
HM624700	Single-row tapered roller bearing, inch series	A9, A55, A56, A59, B265
HM801300	Single-row tapered roller bearing, inch series	A9, A55, A56, A59, B235, B237
HM803100	Single-row tapered roller bearing, inch series	A9, A55, A56, A59, B237, B239
HM804800	Single-row tapered roller bearing, inch series	A9, A55, A56, A59, B237, B239, B241
HM807000	Single-row tapered roller bearing, inch series	A9, A55, A56, A59, B237, B239, B241, B245
HM813800	Single-row tapered roller bearing, inch series	A9, A55, A56, A59, B247, B249, B251, B253
HM81600	Single-row tapered roller bearing, inch series	A9, A55, A56, A59, B225
HM88500	Single-row tapered roller bearing, inch series	A9, A55, A56, A59, B231
HM88600	Single-row tapered roller bearing, inch series	A9, A55, A56, A59, B227, B231, B233
HM89400	Single-row tapered roller bearing, inch series	A9, A55, A56, A59, B231, B233
HN	Locknut for withdrawal sleeve	C46, C51
HNL	Locknut for withdrawal sleeve	C46, C51
IM	Inner ring for machine-tool quality precision-combined bearing, without lubrication hole, metric series	B363, B476
IM-P	Inner ring for needle roller bearing, without lubrication hole, metric series	B363, B463, B466
IR	Inner ring for heavy-duty needle roller bearing, inch series	B363, B440, B478
IR-	Inner ring for heavy-duty needle roller bearing, inch series	A8, A55, A56, A59, B363, B440, B478
J	Drawn cup needle roller bearing, caged, open ends, inch series	A8, B363, B424
JB	Sealed type tapered roller bearing for railway rolling stock axle journal, sealed type cylindrical roller bearing	C22, C27, C29
JC	Cylindrical roller bearing for railway rolling stock axle journal	C22, C25
JH	Drawn cup needle roller bearing, caged, open ends, inch series, high load capacity	A8, B363, B424
JH211700	Single-row tapered roller bearing, inch series	A9, A55, A56, A59, B251
JH217200	Single-row tapered roller bearing, inch series	A9, A55, A56, A59, B259
JH307700	Single-row tapered roller bearing, inch series	A9, A55, A56, A59, B247
JH415600	Single-row tapered roller bearing, inch series	A9, A55, A56, A59, B255
JHM318400	Single-row tapered roller bearing, inch series	A9, A55, A56, A59, B261
JHM516800	Single-row tapered roller bearing, inch series	A9, A55, A56, A59, B259
JHM522600	Single-row tapered roller bearing, inch series	A9, A55, A56, A59, B265
JHM534100	Single-row tapered roller bearing, inch series	A9, A55, A56, A59, B267
JHM720200	Single-row tapered roller bearing, inch series	A9, A55, A56, A59, B263
JHM807000	Single-row tapered roller bearing, inch series	A9, A55, A56, A59, B243
JHM840400	Single-row tapered roller bearing, inch series	A9, A55, A56, A59, B267
JL69300	Single-row tapered roller bearing, inch series	A9, A55, A56, A59, B233
JLM104900	Single-row tapered roller bearing, inch series	A9, A55, A56, A59, B243
JLM506800	Single-row tapered roller bearing, inch series	A9, A55, A56, A59, B245
JLM508700	Single-row tapered roller bearing, inch series	A9, A55, A56, A59, B247
JLM710900	Single-row tapered roller bearing, inch series	A9, A55, A56, A59, B249
JLM714100	Single-row tapered roller bearing, inch series	A9, A55, A56, A59, B255
JLM813000	Single-row tapered roller bearing, inch series	A9, A55, A56, A59, B253

Bearing No. index

Bearing series (series name)	Description	Page
JM205100	Single-row tapered roller bearing, inch series	A9, A55, A56, A59, B243
JM207000	Single-row tapered roller bearing, inch series	A9, A55, A56, A59, B247
JM511900	Single-row tapered roller bearing, inch series	A9, A55, A56, A59, B249
JM515600	Single-row tapered roller bearing, inch series	A9, A55, A56, A59, B257
JM612900	Single-row tapered roller bearing, inch series	A9, A55, A56, A59, B253
JM714200	Single-row tapered roller bearing, inch series	A9, A55, A56, A59, B255
JM716600	Single-row tapered roller bearing, inch series	A9, A55, A56, A59, B259
JM718100	Single-row tapered roller bearing, inch series	A9, A55, A56, A59, B261
JM719100	Single-row tapered roller bearing, inch series	A9, A55, A56, A59, B261
JM720200	Single-row tapered roller bearing, inch series	A9, A55, A56, A59, B263
JM734400	Single-row tapered roller bearing, inch series	A9, A55, A56, A59, B267
JM736100	Single-row tapered roller bearing, inch series	A9, A55, A56, A59, B267
JM738200	Single-row tapered roller bearing, inch series	A9, A55, A56, A59, B267
JM822000	Single-row tapered roller bearing, inch series	A9, A55, A56, A59, B265
JR	Inner ring for needle roller bearing, without lubrication hole, metric series	B363, B415, B461, B466
JR--JS1	Inner ring for needle roller bearing, with lubrication hole, metric series	B363, B466
JRZ--JS1	Inner ring for needle roller bearing, with lubrication hole, without raceway chamfer, metric series	B363, B466
K	Radial needle roller and cage assembly, single-row, metric series	A8, B363, B380
K.811	Thrust cylindrical roller and cage assemblies, without races, metric series	A12, B363, B448
K.812	Thrust cylindrical roller and cage assemblies, without races, metric series	A12, B363, B448
K-ZW	Radial needle roller and cage assembly, double-row, metric series	A8, B363, B382
K-A	K-series super thin section ball bearing, angular contact type, the T, A, B, and C between K and A indicate the cross-section dimensions	C2, C9
K-C	K-series super thin section ball bearing, deep groove type, the T, A, B, and C between K and C indicate the cross-section dimensions	C2, C9
K-X	K-series super thin section ball bearing, four-point contact type, the T, A, B, and C between K and X indicate the cross-section dimensions	C2, C9
KJA--RD	K-series super thin section ball bearing, angular contact type, with seal	C2, C19
KUC--2RD	K-series super thin section ball bearing, deep groove type, with seals	C2, C19
KUX--2RD	K-series super thin section ball bearing, four-point contact type, with seals	C2, C19
L102800	Single-row tapered roller bearing, inch series	A9, A55, A56, A59, B239
L21500	Single-row tapered roller bearing, inch series	A9, A55, A56, A59, B225
L217800	Single-row tapered roller bearing, inch series	A9, A55, A56, A59, B259
L305600R	Single-row tapered roller bearing, inch series	A9, A55, A56, A59, B243
L319200	Single-row tapered roller bearing, inch series	A9, A55, A56, A59, B261
L327200	Single-row tapered roller bearing, inch series	A9, A55, A56, A59, B267
L435000	Single-row tapered roller bearing, inch series	A9, A55, A56, A59, B267
L44600R	Single-row tapered roller bearing, inch series	A9, A55, A56, A59, B227

Bearing series (series name)	Description	Page
L45400	Single-row tapered roller bearing, inch series	A9, A55, A56, A59, B229
L521900R	Single-row tapered roller bearing, inch series	A9, A55, A56, A59, B263
L540000	Single-row tapered roller bearing, inch series	A9, A55, A56, A59, B267
L555200	Single-row tapered roller bearing, inch series	A9, A55, A56, A59, B267
L68100	Single-row tapered roller bearing, inch series	A9, A55, A56, A59, B233
LL319300	Single-row tapered roller bearing, inch series	A9, A55, A56, A59, B261
LL713000	Single-row tapered roller bearing, inch series	A9, A55, A56, A59, B253
LM102900	Single-row tapered roller bearing, inch series	A9, A55, A56, A59, B241
LM11700R	Single-row tapered roller bearing, inch series	A9, A55, A56, A59, B225
LM11900	Single-row tapered roller bearing, inch series	A9, A55, A56, A59, B225
LM12700	Single-row tapered roller bearing, inch series	A9, A55, A56, A59, B225
LM245800	Single-row tapered roller bearing, inch series	A9, A55, A56, A59, B267
LM29700	Single-row tapered roller bearing, inch series	A9, A55, A56, A59, B235
LM48500	Single-row tapered roller bearing, inch series	A9, A55, A56, A59, B231
LM501300	Single-row tapered roller bearing, inch series	A9, A55, A56, A59, B237
LM503300R	Single-row tapered roller bearing, inch series	A9, A55, A56, A59, B241
LM522500	Single-row tapered roller bearing, inch series	A9, A55, A56, A59, B263, B265
LM603000	Single-row tapered roller bearing, inch series	A9, A55, A56, A59, B241
LM613400	Single-row tapered roller bearing, inch series	A9, A55, A56, A59, B253
LM67000	Single-row tapered roller bearing, inch series	A9, A55, A56, A59, B231
LM72800	Single-row tapered roller bearing, inch series	A9, A55, A56, A59, B227
LM806600	Single-row tapered roller bearing, inch series	A9, A55, A56, A59, B245
LM814800	Single-row tapered roller bearing, inch series	A9, A55, A56, A59, B257
LS	Needle roller thrust bearing, assemblies, washers, thrust needle roller and cage assemblies, thrust washers, metric series	A12, B363, B444
M12600	Single-row tapered roller bearing, inch series	A9, A55, A56, A59, B225
M246900	Single-row tapered roller bearing, inch series	A9, A55, A56, A59, B267
M249700	Single-row tapered roller bearing, inch series	A9, A55, A56, A59, B267
M349500	Single-row tapered roller bearing, inch series	A9, A55, A56, A59, B267
M802000	Single-row tapered roller bearing, inch series	A9, A55, A56, A59, B237
M804000	Single-row tapered roller bearing, inch series	A9, A55, A56, A59, B241
M84200	Single-row tapered roller bearing, inch series	A9, A55, A56, A59, B227
M86600R	Single-row tapered roller bearing, inch series	A9, A55, A56, A59, B227, B229
M88000	Single-row tapered roller bearing, inch series	A9, A55, A56, A59, B231
MJ--1	Drawn cup needle roller bearing, caged, closed one end, inch series	A8, B363, B424
MJH--1	Drawn cup needle roller bearing, caged, closed one end, inch series, high load capacity	A8, B363, B424
ML	Extra-small ball bearing, miniature ball bearing, open type	A4, A56, B5, B40
ML--ZZ	Extra-small ball bearing, miniature ball bearing, shielded	A4, A56, B5, B42
MLF	Extra-small ball bearing, miniature ball bearing, flanged type, open type	A4, A56, B5, B46
N2	Single-row cylindrical roller bearing, outer ring without ribs, inner ring with ribs	A7, A56, B139, B142
N3	Single-row cylindrical roller bearing, outer ring without ribs, inner ring with ribs	A7, A56, B139, B142

Bearing No. index

Bearing series (series name)	Description	Page
N4	Single-row cylindrical roller bearing, outer ring without ribs, inner ring with ribs	A7, A56, B139, B144
NAXK	Combined needle roller bearing, combination heavy-duty needle roller and thrust ball bearing, caged, without inner ring, metric series	B363, B460
NAXK--Z	Combined needle roller bearing, combination heavy-duty needle roller and thrust ball bearing, caged, without inner ring, with dust cap, metric series	B363, B460
NAXR	Combined needle roller bearing, combination heavy-duty needle roller and thrust cylindrical roller bearing, caged, without inner ring, metric series	B363, B462
NAXR--Z	Combined needle roller bearing, combination heavy-duty needle roller and thrust cylindrical roller bearing, caged, without inner ring, with dust cap, metric series	B363, B462
NF2	Single-row cylindrical roller bearing, outer ring without rib on single side, inner ring with ribs	A7, A56, B139, B142
NF3	Single-row cylindrical roller bearing, outer ring without rib on single side, inner ring with ribs	A7, A56, B139, B142
NF4	Single-row cylindrical roller bearing, outer ring without rib on single side, inner ring with ribs	A7, A56, B139, B144
NJ2	Single-row cylindrical roller bearing, outer ring with ribs, inner ring without rib on single side	A7, A56, B139, B142
NJ22	Single-row cylindrical roller bearing, outer ring with ribs, inner ring without rib on single side	A7, A56, B139, B142
NJ23	Single-row cylindrical roller bearing, outer ring with ribs, inner ring without rib on single side	A7, A56, B139, B142
NJ3	Single-row cylindrical roller bearing, outer ring with ribs, inner ring without rib on single side	A7, A56, B139, B142
NJ4	Single-row cylindrical roller bearing, outer ring with ribs, inner ring without rib on single side	A7, A56, B139, B144
NK	Heavy-duty needle roller bearing, caged, with ribs (inserted or integral), without inner ring, metric series	A8, A55, A56, A59, B363, B432
NKS	Heavy-duty needle roller bearing, caged, with ribs (inserted or integral), without inner ring, one lubrication hole and lubrication groove in the outer ring, metric series	A8, A55, A56, A59, B363, B433
NN30	Double-row cylindrical roller bearing, outer ring without ribs, inner ring with ribs	A7, A55, A56, B139, B178
NN30--K	Double-row cylindrical roller bearing, outer ring without ribs, inner ring with ribs, tapered bore	A7, A56, B139, B178
NNU49	Double-row cylindrical roller bearing, outer ring with ribs, inner ring without ribs	A7, A55, A56, B139, B178
NNU49--K	Double-row cylindrical roller bearing, outer ring with ribs, inner ring without ribs, tapered bore	A7, A56, B139, B178
NTA	Thrust needle roller and cage assemblies, without races, two-piece cage, inch series	A12, B363, B452
NU10	Single-row cylindrical roller bearing, outer ring with ribs, inner ring without ribs	A7, A55, A56, B139, B142
NU2	Single-row cylindrical roller bearing, outer ring with ribs, inner ring without ribs	A7, A55, A56, B139, B142

Bearing series (series name)	Description	Page
NU22	Single-row cylindrical roller bearing, outer ring with ribs, inner ring without ribs	A7, A55, A56, B139, B142
NU23	Single-row cylindrical roller bearing, outer ring with ribs, inner ring without ribs	A7, A55, A56, B139, B142
NU3	Single-row cylindrical roller bearing, outer ring with ribs, inner ring without ribs	A7, A55, A56, B139, B142
NU32	Single-row cylindrical roller bearing, outer ring with ribs, inner ring without ribs	A7, A55, A56, B139, B142
NU33	Single-row cylindrical roller bearing, outer ring with ribs, inner ring without ribs	A7, A55, A56, B139, B144
NU4	Single-row cylindrical roller bearing, outer ring with ribs, inner ring without ribs	A7, A55, A56, B139, B144
NUP10	Single-row cylindrical roller bearing, outer ring with ribs, inner ring without rib on single side, with loose rib	A7, A56, B139, B142
NUP2	Single-row cylindrical roller bearing, outer ring with ribs, inner ring without rib on single side, with loose rib	A7, A56, B139, B142
NUP22	Single-row cylindrical roller bearing, outer ring with ribs, inner ring without rib on single side, with loose rib	A7, A56, B139, B142
NUP23	Single-row cylindrical roller bearing, outer ring with ribs, inner ring without rib on single side, with loose rib	A7, A56, B139, B142
NUP3	Single-row cylindrical roller bearing, outer ring with ribs, inner ring without rib on single side, with loose rib	A7, A56, B139, B142
NUP4	Single-row cylindrical roller bearing, outer ring with ribs, inner ring without rib on single side, with loose rib	A7, A56, B139, B144
RAXZ5	Combined needle roller bearing, combination heavy-duty needle roller and thrust cylindrical roller bearing, caged, without inner ring, with dust cap, non-separable design, metric series	B363, B462
RNA48	Heavy-duty needle roller bearing, caged, with ribs (integral), without inner ring, one lubrication hole and lubrication groove in the outer ring, metric series	A8, A55, A56, A59, B363, B438
RNA49	Heavy-duty needle roller bearing, caged, with ribs (integral), without inner ring, one lubrication hole and lubrication groove in the outer ring, metric series	A8, A55, A56, A59, B363, B432
RNA69	Heavy-duty needle roller bearing, caged, with ribs (inserted or integral), without inner ring, one lubrication hole and lubrication groove in the outer ring, metric series	A8, A55, A56, A59, B363, B432
SDE	Linear ball bearing, metric series	C32, C35
SDM	Linear ball bearing, metric series	C32, C35
SDMF	Linear ball bearing, round-flanged type, metric series	C32, C41
SDMK	Linear ball bearing, square-flanged type, metric series	C32, C41
TR	Race A, B, C, etc. indicates race thickness	A12, B363, B452

Bearing No. index

Bearing series (series name)	Description	Page
W W60..ZZX	Extra-small ball bearing, miniature ball bearing, shielded	A4, A56, B5, B40
W68..2RD	Extra-small ball bearing, miniature ball bearing, extremely light contact sealed	A4, A56, B5, B44
W68..2RS	Extra-small ball bearing, miniature ball bearing, contact sealed	A4, A56, B5, B44
W68..2RU	Extra-small ball bearing, miniature ball bearing, non-contact sealed	A4, A56, B5, B44
W68..ZZ	Extra-small ball bearing, miniature ball bearing, shielded	A4, A56, B5, B40
W69..ZZ	Extra-small ball bearing, miniature ball bearing, shielded	A4, A56, B5, B40
WF60..ZZ	Extra-small ball bearing, miniature ball bearing, flanged type, shielded	A4, A56, B5, B46
WF68..ZZ	Extra-small ball bearing, miniature ball bearing, flanged type, shielded	A4, A56, B5, B46
WF69..ZZ	Extra-small ball bearing, miniature ball bearing, flanged type, shielded	A4, A56, B5, B46
WJ	Radial needle roller and cage assembly, single-row, inch series, high load capacity	A8, B363, B408
WJC	Radial needle roller and cage assembly, single-row, inch series	A8, B363, B408
WML..2RS	Extra-small ball bearing, miniature ball bearing, contact sealed	A4, A56, B5, B42
WML..ZZ	Extra-small ball bearing, miniature ball bearing, shielded	A4, A56, B5, B40
WMLF..ZZ	Extra-small ball bearing, miniature ball bearing, flanged type, shielded	A4, A56, B5, B46
WS.811	Race, thrust needle roller and cylindrical roller, shaft piloted, metric series	A12, B363, B444
WS.812	Race for thrust cylindrical roller and cage assembly, shaft piloted, metric series	A12, B363, B448

Term index Page numbers in bold indicate detailed pages.

Term	Page	Term	Page
A adapter	A6, A10, A91, A136 , A145	constant pressure preloading	A112 , A113
additives	A124, A125 , A128, A154	contact angle	A1 , A5, A6, A9, A39, A54, A56, A103, A116
allowable aligning angle	B125 , B293 , B355	contact angle code	A54 , A56, A57
allowable axial load	A14, A44 , A49, B141	contamination factor	A27, A29
allowable misalignment	B7 , B58 , B141 , B187 , B337	corrosion	A154 , A155
amount of grease	A117	crack	A141, A150, A152 , A153 , A156, A157
amount of mist	A121, A123	cracking	A150, A152 , A153 , A156, A157
amount of preload	A15, A112 , A113 , A114 , A116, A147	creeping	A24, A86, A156
axial internal clearance	A99 , A103, A104, A111	cup grease	A124 , A137
B base oil	A124 , A126	D damage to cage	A156
basic number	A54 , A56	diameter series	A17, A44, A49, A52 , A53, A55
basic rating life	A24 , A25, A26, A27	dimension series	A9, A16, A17, A52 , A53, A54, A55
bearing arrangement	A14, A20 , A21, A22, A23	discoloration	A154 , A155
bearing ring	A1 , A5, A6, A54, A56, A130	dismounting	A15, A17, A148 , A149
bearing series	A54 , A55, A56, A57	distribution load	A43
bearing steel	A57, A88, A101, A130 , A131	dynamic equivalent load	A14, A24, A25, A38 , A40, A49, A84
bentone	A124 , A125	dynamic load rating	A14, A24 , A25, A26, A38 , A46, A48, A49, A51, A84, A130
bore diameter number	A52 , A54, A56, A114	E effective clearance	A99 , A100
brinelling	A141, A147, A152 , A153 , A154, A155, A156, A157	effective interference	A88 , A89 , A101, A143
C cage	A1 , A4, A5, A6, A7, A8, A9, A10, A11, A12, A13, A14, A54, A56, A57, A85, A130, A132, A156	electric pitting	A154
cage material / shape code	A57	end plate	A136
calcium complex soap	A125	equivalent axial load	B141 , B337 , B355
calcium grease	A124 , A137	equivalent radial load	B7 , B58 , B59, B125 , B141 , B187 , B293
calcium soap	A124	extreme pressure agent	A29, A125
calculated interference	A88	F failure	A24 , A152, A153, A154, A155, A156, A157
case hardened steel	A130	fatigue load limit	A26, A27, A29
chamfer	A4, A11	feeding interval	A118
chamfer dimension	A52 , A58, A78, A133, A134	fiber grease	A124
clearance fit	A86 , A87 , A90, A111, A142, A153	fillet	A133 , A134 , A141, A153
comparison of performance	A14, A16, A18	filling slot	A4 , A5, A18, A55, B57
complex base grease	A125	fit	A15, A86 , A87, A88, A89, A100, A101, A133, A134, A142, B7 , B57 , B125 , B140 , B186 , B293 , B337 , B355 , B376
consistency	A125 , A126, A127, A137		

Term index Page numbers in bold indicate detailed pages.

Term	Page
flaking	A24, A147, A150, A152, A153
flinger	A137, A138
fluorine compounds	A124 , A125
forced oil circulation	A85, A122
fretting	A24, A156, A157
frictional coefficient	A85 , A122
gear coefficient	A34 , A50
grease	A57, A117 , A118, A124, A125 , A126, A140
grease code	A57
grease lubrication	A29, A44, A84, A117 , A137, A140
grease service life	A15, A118, A119
heavy preload	A57, A114 , A115
height series	A52, A53
HM	A139
HMA	A139
HMS	A139
HMSA	A139
HMSAH	A139
HMSH	A139
inner case	A139
inner ring back face rib	A9
inner ring front face rib	A9, A10
inspection	A150
inspection of shaft and housing	A141
interference	A21, A23, A86, A88, A89 , A93, A96, A111, A115, A142, A143, A144, A148, A153, A157
interference fit	A86, A87 , A90, A111, A142, A148
internal clearance	A15, A54, A57, A99, B57, B186, B376
internal design code	A54 , A56
J series	A94, A59 , A72
kinematic viscosity	A29, A30, A128 , A129
labyrinth	A137, A138
life	A14, A24 , A40, A46, A48, A50, A114, A117, A130, A152
life modification factor	A26, A27 , A28
life modification factor for reliability	A27
light preload	A57, A114 , A115

Term	Page
limiting speed	A15, A16, A84 , A85
lithium complex soap	A125
lithium grease	A124
lithium soap	A124
load center	A5, A6, A9, A39, A113
load coefficient	A32 , A34, A38, A42, A50
locating snap ring	A4, A53 , A56
lubricant	A14, A15, A29, A117, A124 , A140, A141, A147, A151, A155, A157
lubricating oil	A121, A122, A124, A128 , A129
lubrication	A117
lubrication conditions	A14, A29
lubrication groove	A7, A8, A9, A10, A56 , A123, A137, B292
lubrication hole	A7, A8, A9, A10, A56, A123, B292
lubrication method	A15, A85, A117 , A153, A155, A157
maintenance	A150
material	A14, A130, A132 , A140
material code	A57
measured clearance	A99 , A102, A103
measuring method	A80
medium preload	A57, A114 , A115
MH	A139
MHA	A139
MHS	A139
MHSA	A139
mineral oil	A124 , A125, A126, A128
minor lip	A139
modified rating life	A26 , A27
mounting	A15, A17, A141 , A142, A143, A144, A145, A146
mounting design	A136
mounting dimensions	A15, A134
MS	A139
nicks	A152, A153
NLGI	A125 , A127
noise	A147
non-soap base grease	A124 , A125
NR	A4, A56
oil / air lubrication	A85, A122
oil bath	A120

Term	Page
oil drip	A120
oil jet lubrication	A85, A121, A122
oil lubrication	A13, A44, A47, A49, A84, A117, A120
oil mist lubrication	A123
oil seal	A139 , A140
oil splash	A120
operating clearance	A99, A100 , A101
original clearance	A99 , A100
oxidation inhibitor	A125 , A128
pear skin	A154, A155
position preloading	A112 , A113
preload	A16, A57, A112, A113 , A155, A157
preload code	A57
press fit	A142 , A143
radial internal clearance	A57, A99 , A102, A104, A105, A106, A108, A110, A111, A145, A146, B7, B125, B140, B293
RD	A4, A56
recommended fits	A90 , A91, A92, A93, A94, A95, A96, A97, A98, A114, A115
required service life	A14, A25, A31 , A48, A49
residual clearance	A99 , A100, A146
rib	A7, A8, A44
rolling element	A1 , A6, A16, A24, A29, A42, A101, A130, A147, A156
rotating inner ring load	A87 , A90, A94, A95, A96, A97, A98
rotating outer ring load	A87 , A90, A94, A95, A96, A97, A98
RS	A4, A5, A6, A8, A56, A85
RU	A4, A56
rubbing speed	A85, A140
rust	A154, A155
safety coefficient	A14, A43
scratch	A154, A155
scuffing	A154, A155
seal code	A56
sealing device	A15, A137 , A138, A139, A140
sealing edge	A139
sealing lip	A139
seizure	A24, A153, A154, A156

Term	Page
service life of bearing system	A30
shaft and housing design	A133
shaft locknut	A136
shrink fit	A142, A144
slight preload	A57, A114 , A115
smearing	A154, A155
snug fit	A86
sodium grease	A124
sodium soap	A124
spacer code	A57
spray lubrication	A121
standard cage	B7, B58, B125, B140, B186, B293, B337, B355
stand-out	A5 , A9, A56, A112
static equivalent load	A14, A42 , A43
static load rating	A14, A24, A42 , A43, A88
stationary inner ring load	A87 , A90, A98
stationary outer ring load	A87 , A90, A98
storage	A141
structure	A1
supplementary code	A5, A9, A10, A54, A57
synthetic oil	A124 , A125, A128
tapered bore	A6, A7, A10, A17, A52, A54, A56, A58, A61, A63, A76 , A80, A91, A105, A107, A136, A142, A145, A146, A149
test run	A146
thickener	A124 , A125, A126
tolerance	A58 , A59, B7, B57, B125, B140, B186, B293, B337, B355, B368
tolerance class	A15, A54, A57, A58, A59 , A93, A94, A95, A96, A97
transition fit	A86 , A90
urea compounds	A124 , A125
viscosity grade	A129
viscosity ratio	A27, A29
wear	A24, A156, A157
width series	A17, A52, A53, A55
withdrawal sleeve	A10, A91, A136 , A145
Z	A4, A5, A54, A56

GLOBAL NETWORK

http : // www. jtekt. co. jp

For further information on our products, please contact your nearest office.

OFFICES

KOYO CANADA INC.

3800A Laird Road, Units 4 & 5 Mississauga, Ontario L5L 0B2,
CANADA
TEL : 1-905-820-2090
FAX : 1-877-326-5696

JTEKT NORTH AMERICA CORPORATION

-Main Office-

47771 Halyard Drive, Plymouth, MI 48170, U.S.A.
TEL : 1-734-454-1500
FAX : 1-734-454-7059

-Cleveland Office-

29570 Clemens Road, P.O.Box 45028, Westlake,
OH 44145, U.S.A.
TEL : 1-440-835-1000
FAX : 1-440-835-9347

-Chicago Office-

316 W University Dr., Arlington Heights, IL 60004, U.S.A.
TEL : 1-847-253-0340
FAX : 1-847-253-0540

KOYO MEXICANA, S.A. DE C.V.

Av. Insurgentes Sur 2376-505, Col. Chimalistac, C.P. 01070,
Del. Álvaro Obregón, México, D.F.
TEL : 52-55-5207-3860
FAX : 52-55-5207-3873

KOYO LATIN AMERICA, S.A.

Edificio Banco del Pacifico, Planta Baja, Calle Aquilino de la
Guardia y Calle 52, Panama, REPUBLICA DE PANAMA
TEL : 507-208-5900
FAX : 507-264-2782/507-269-7578

KOYO ROLAMENTOS DO BRASIL LTDA.

Avenida Brigadeiro Faria Lima, 1744 - 1st Floor - C.J. 11, Jardim
Paulistano, São Paulo - SP - Brazil CEP 01451-001
TEL : 55-11-3372-7500
FAX : 55-11-3887-3039

KOYO MIDDLE EAST FZE

6EA 801, Dubai Airport Free Zone, P.O. Box 54816, Dubai, U.A.E.
TEL : 97-1-4299-3600
FAX : 97-1-4299-3700

KOYO BEARINGS INDIA PVT. LTD.

506-507, 5th Floor, Suncity Business Tower, Golf Course
Road, Sector-54, Gurgaon-122002, Haryana, INDIA
TEL : 91-124-4264601/03
FAX : 91-124-4288355

JTEKT (THAILAND) CO., LTD.

172/1 Moo 12 Tambol Bangwua, Amphur Bangpakong,
Chachoengsao 24180, THAILAND
TEL : 66-38-533-310-7
FAX : 66-38-532-776

PT. JTEKT INDONESIA

Jl. Surya Madya Plot I-27b, Kawasan Industri Surya Cipta,
Kutanegara, Ciampel, Karawang Jawa Barat, 41363 INDONESIA
TEL : 62-267-8610-270
FAX : 62-267-8610-271

KOYO SINGAPORE BEARING (PTE.) LTD.

27, Penjuru Lane, Level 5, Phase 1 Warehouse #05-01.
SINGAPORE 609195
TEL : 65-6274-2200
FAX : 65-6862-1623

PHILIPPINE KOYO BEARING CORPORATION

8th Floor, One World Square Building, #10 Upper McKinley
Road, McKinley Town Center Fort Bonifacio, 1634 Taguig City,
PHILIPPINES
TEL : 63-2-856-5046/5047
FAX : 63-2-856-5045

JTEKT KOREA CO., LTD.

Seong-do Bldg 13F, 207, Dosan-dearo, Gangnam-Gu, Seoul,
KOREA
TEL : 82-2-549-7922
FAX : 82-2-549-7923

JTEKT (CHINA) CO., LTD.

Room 25A2, V-CAPITAL Building, 333 Xianxia Road, Changning
District, Shanghai 200336, CHINA
TEL : 86-21-5178-1000
FAX : 86-21-5178-1008

KOYO AUSTRALIA PTY. LTD.

Unit1/17 Stanton Road, Seven Hills, NSW, 2147, AUSTRALIA

JTEKT EUROPE BEARINGS B.V.

Markerkant 13-01, 1314 AL Almere, THE NETHERLANDS
TEL : 31-36-5383333
FAX : 31-36-5347212

-Benelux Branch Office-

Energieweg 10a, 2964 LE, Groot-Ammers, THE NETHERLANDS
TEL : 31-184-606800
FAX : 31-184-606857

KOYO KULLAGER SCANDINAVIA A.B.

Johanneslundsvägen 4, 194 61 Upplands Väsby, SWEDEN
TEL : 46-8-594-212-10
FAX : 46-8-594-212-29

KOYO (U.K.) LIMITED

Whitehall Avenue, Kingston, Milton Keynes MK10 0AX,
UNITED KINGDOM
TEL : 44-1908-289300
FAX : 44-1908-289333

KOYO DEUTSCHLAND GMBH

Bargkoppelweg 4, D-22145 Hamburg, GERMANY
TEL : 49-40-67-9090-0
FAX : 49-40-67-9203-0

KOYO FRANCE S.A.

1 rue François Jacob, 92500, Rueil Malmaison, FRANCE
TEL : 33-1-4139-8006/18

KOYO IBERICA, S.L.

Centro de Negocios, Call La Mancha no.1, oficina 1.2 28823
costada, Madrid, SPAIN
TEL : 34-91-329-0818
FAX : 34-91-747-1194

KOYO ITALIA S.R.L.

Via Stephenson 43/a 20157 Milano, ITALY
TEL : 39-02-2951-0844
FAX : 39-02-2951-0954

-Romanian Representative Office-

24, Lister Street, ap. 1, sector 5, Bucharest, ROMANIA
TEL : 40-21-410-4182
FAX : 40-21-410-1178

PUBLISHER

JTEKT CORPORATION NAGOYA HEAD OFFICE

No.7-1, Meieki 4-chome, Nakamura-ku, Nagoya, Aichi 450-8515, JAPAN TEL:81-52-527-1900 FAX:81-52-527-1911

JTEKT CORPORATION OSAKA HEAD OFFICE

No.5-8, Minamisemba 3-chome, Chuo-ku, Osaka 542-8502, JAPAN TEL:81-6-6271-8451 FAX:81-6-6245-3712

Sales & Marketing Headquarters

No.5-8, Minamisemba 3-chome, Chuo-ku, Osaka 542-8502, JAPAN TEL:81-6-6245-6087 FAX:81-6-6244-9007

Koyo® Ball & Roller Bearings



CAT. NO. B2001E-7
Printed in Japan '17.09-3CDS (06.1)

JTEKT

JTEKT CORPORATION